

**YATO** ®

**2015**



**25**  
YEARS  

**1 SPANNERS / KLUCZE** 4-23

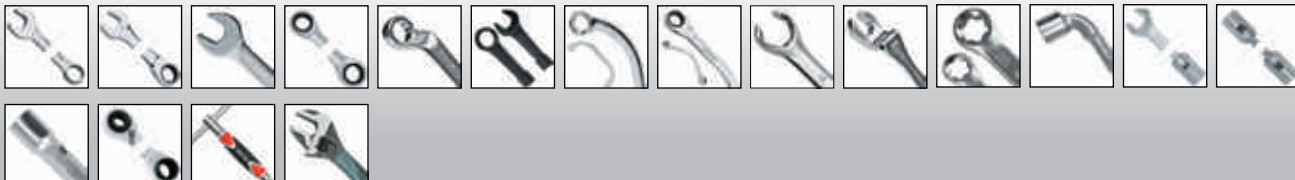

**2 SOCKETS, ACCESSORIES & SETS / KLUCZE NASADOWE, AKCESORIA I ZESTAWY** 24-75



**3 IMPACT SOCKETS, ACCESSORIES & SETS / UDAROWE KLUCZE NASADOWE, AKCESORIA I ZESTAWY** 76-85



**4 TORQUE WRENCHES & TORQUE MULTIPLIERS / KLUCZE DYNAMOMETRYCZNE I WZMACNIACZE MOMENTU** 86-89



**5 SCREWDRIVERS & SCREWDRIVER BITS / WKREŹAKI I KOŃCÓWKI WKREŹAKOWE** 90-117



**6 PLIERS & PIPE WRENCHES / SZCZYPCE I KLUCZE DO RUR** 118-135



**7 ELECTRICIAN TOOLS / NARZĘDZIA DLA ELEKTRYKÓW** 136-153



**8 HAMMERS, CHISELS, PUNCHES & AXES / MŁOTKI, DŁUTA, PRZECINAKI I SIEKIERY** 154-163



**9 CLAMPS, VICES & HOLDERS / ŚCISKI, IMADŁA I WSPORNIKI** 164-169



**10 CUTTING TOOLS / NARZĘDZIA TNĄCE** 170-221



**11 HYDRAULIC TOOLS / NARZĘDZIA HYDRAULICZNE** 222-233





|           |   |         |
|-----------|---|---------|
| <b>12</b> | <b>FASTENING TOOLS / NARZĘDZIA DO ŁĄCZENIA</b>  | 234-247 |
|           |   |         |
| <b>13</b> | <b>CONSTRUCTION TOOLS / NARZĘDZIA BUDOWLANE</b>   | 248-263 |
|           |   |         |
| <b>14</b> | <b>MEASURING TOOLS / NARZĘDZIA MIERNICZE</b>  | 264-273 |
|           |   |         |
| <b>15</b> | <b>PNEUMATIC TOOLS / NARZĘDZIA PNEUMATYCZNE</b>   | 274-287 |
|           |   |         |
| <b>16</b> | <b>SPECIAL AUTOMOTIVE TOOLS &amp; EQUIPMENT / NARZĘDZIA I WYPOSAŻENIE WARSZTATU SAMOCHODOWEGO</b> | 288-377 |
|           |   |         |
| <b>17</b> | <b>WELDING EQUIPMENT &amp; ACCESSORIES / NARZĘDZIA SPAWALNICZE I AKCESORIA</b>                    | 378-389 |
|           |   |         |
| <b>18</b> | <b>POWER &amp; GASOLINE TOOLS / ELEKTRONARZĘDZIA I NARZĘDZIA SPALINOWE</b>                        | 390-409 |
|           |   |         |
| <b>19</b> | <b>PADLOCKS &amp; LOCK CYLINDERS / KLÓDKI I WKŁADKI DO ZAMKÓW</b>                                 | 410-413 |
|           |   |         |
| <b>20</b> | <b>ACCESSORIES / AKCESORIA</b>  | 414-417 |
|           |   |         |
| <b>21</b> | <b>HEALTH &amp; SAFETY ARTICLES / ARTYKUŁY BHP</b>  | 418-429 |
|           |   |         |
| <b>22</b> | <b>ELECTRIC PRODUCTS / ARTYKUŁY ELEKTRYCZNE</b>   | 430-439 |
|           |   |         |
| <b>23</b> | <b>GARDEN TOOLS / NARZĘDZIA OGRODNICZE</b>  | 440-461 |
|           |   |         |

# 1

## Spanners Klucze





**Combination spanners**  
Klucze płasko-oczkowe

6-9



**Reversible ratchet half-moon spanners**  
Klucze oczkowe typu „C” z grzechotką

18



**Combination spanners & sets, polished head**

Klucze płasko-oczkowe i zestawy, polerowana główka.....

6

**Combination spanners & sets, satin finish**

Klucze płasko-oczkowe i zestawy, wykończenie satynowe.....

7

**Combination spanners S.A.E., polished head**

Klucze płasko-oczkowe S.A.E., polerowana główka.....

8

**Stubby combination spanners, polished head**

Klucze płasko-oczkowe krótkie, polerowana główka.....

9

**Flare nut wrenches & sets**

Klucze oczkowe półotwarte i zestawy

18



**Flexible flare nut wrenches & sets**

Klucze oczkowe półotwarte z przegubem i zestawy

19



**Combination ratchet wrenches**

Klucze płasko-oczkowe z grzechotką

9-11



**Torx ring spanner sets**

Zestawy kluczy oczkowych „Torx”

19



**Combination ratchet wrenches & sets**

Klucze płasko-oczkowe z grzechotką i zestawy.....

9

**Non-slip combination ratchet wrenches**

Klucze płasko-oczkowe z grzechotką „Non-slip”.....

10

**Rapid spline ratchet wrenches**

Klucze „szybkie” z grzechotką „Spline”.....

11

**Flexible ratchet combination wrenches**

Klucze płasko-oczkowe z grzechotką i przegubem.....

11

**L-type socket wrenches**

Klucze nasadowe typu „L”

19



**Double open end spanners**

Klucze płaskie

12-13



**Open end swivel head socket wrenches & sets**

Klucze płasko-nasadowe, przegubowe i zestawy

20



**Double open end spanners & sets, polished head**

Klucze płaskie i zestawy, polerowana główka.....

12

**Double open end spanners & sets, satin finish**

Klucze płaskie i zestawy, wykończenie satynowe.....

13

**Double open end spanners S.A.E., polished head**

Klucze płaskie S.A.E., polerowana główka.....

13

**Double flexible socket wrenches**

Klucze nasadowe, przegubowe

20



**Tubular socket wrenches & accessories**

Klucze rurowe kute i akcesoria

21



**Double ratchet spanners & sets**

Klucze oczkowe z grzechotką i zestawy

14



**Double ratchet wrenches**

Dwustronne klucze nasadowe z grzechotką

21



**Bi-hexagonal ring spanners**

Klucze oczkowe odgięte

14-16



**T-type & Y-type socket wrenches**

Klucze nasadowe typu „T” i typu „Y”

21-22



**Bi-hexagonal ring spanners & sets, polished head**

Klucze oczkowe odgięte i zestawy, polerowana główka.....

14

**Bi-hexagonal ring spanners & sets, satin finish**

Klucze oczkowe odgięte i zestawy, wykończenie satynowe.....

15

**Bi-hexagonal ring spanners S.A.E., polished head**

Klucze oczkowe odgięte S.A.E., polerowana główka.....

16

**Socket wrenches with handle**

Klucze nasadowe z rękojeścią.....

21

**T-type deep socket wrenches with rotary handle**

Klucze nasadowe typu „T” z obrotową rączką.....

22

**T-type adapters with rotary handle**

Adaptory typu „T” z obrotową rączką.....

22

**T-type deep socket wrenches**

Klucze nasadowe typu „T”.....

22

**Y-type socket wrenches**

Klucze nasadowe typu „Y”.....

22

**Impact wrenches**

Klucze do pobijania

17



**Adjustable wrenches**

Klucze nastawne

23



**Ring impact wrenches**

Klucze oczkowe do pobijania.....

17

**Open end impact wrenches**

Klucze płaskie do pobijania.....

17

**Half-moon spanners**

Klucze oczkowe typu „C”

18



1

GB Combination spanner  
 D Maulringschlüssel  
 PL Klucz płasko-oczkowy  
 RUS Ключ комбинированный  
 CZ Plochý a očkový klič  
 H Kulcs villás-csillag  
 RO Cheie combinată

F Clé mixte à cliquet  
 I Chiave combinata  
 E Combinada con llave de estrella  
 CN 两用扳手

DIN 3113 CrV AS-DRIVE

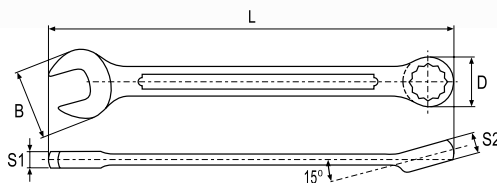

- application: workshop
- head offset: 15°
- surface finish: chromed, satin

- przeznaczenie: warsztat
- kąt odchylenia główek: 15°
- wykończenie powierzchni: chromowana, satynowa

COLOR BOX



| YATO    | Ø (mm) | L (mm) | B (mm) | D (mm) | S1 (mm) | S2 (mm) | PCS packing |         |
|---------|--------|--------|--------|--------|---------|---------|-------------|---------|
| YT-0335 | 6      | 110    | 14.8   | 10.5   | 3.7     | 4.9     | 10          | 300/600 |
| YT-0336 | 7      | 120    | 16.1   | 11.3   | 4.0     | 5.3     | 10          | 300/600 |
| YT-0337 | 8      | 130    | 18.5   | 12.9   | 4.2     | 5.0     | 10          | 180/360 |
| YT-0338 | 9      | 140    | 20.5   | 14.6   | 4.2     | 5.0     | 10          | 180/360 |
| YT-0339 | 10     | 150    | 22.2   | 16.2   | 4.9     | 6.4     | 10          | 180/360 |
| YT-0340 | 11     | 160    | 25.5   | 17.3   | 4.9     | 7.0     | 10          | 180/360 |
| YT-0341 | 12     | 170    | 26.7   | 18.7   | 5.3     | 7.6     | 10          | 120/240 |
| YT-0342 | 13     | 180    | 28.0   | 19.6   | 5.5     | 8.2     | 10          | 120/240 |
| YT-0343 | 14     | 190    | 30.3   | 21.4   | 5.9     | 7.7     | 10          | 50/100  |
| YT-0344 | 15     | 200    | 32.8   | 22.8   | 6.2     | 8.5     | 10          | 50/100  |
| YT-0345 | 16     | 210    | 33.9   | 23.7   | 6.1     | 9.1     | 10          | 50/100  |
| YT-0346 | 17     | 220    | 35.9   | 24.7   | 6.5     | 9.1     | 10          | 50/100  |
| YT-0347 | 18     | 230    | 37.8   | 26.9   | 6.9     | 10.0    | 10          | 50/100  |

| YATO    | Ø (mm) | L (mm) | B (mm) | D (mm) | S1 (mm) | S2 (mm) | PCS packing |        |
|---------|--------|--------|--------|--------|---------|---------|-------------|--------|
| YT-0348 | 19     | 235    | 38.9   | 27.7   | 7.0     | 10.1    | 10          | 50/100 |
| YT-0349 | 20     | 250    | 41.4   | 29.2   | 7.3     | 11.0    | 10          | 40/80  |
| YT-0350 | 21     | 260    | 43.4   | 31.0   | 7.1     | 10.9    | 10          | 40/80  |
| YT-0351 | 22     | 270    | 45.9   | 32.2   | 8.1     | 11.2    | 5           | 20/40  |
| YT-0352 | 23     | 280    | 47.8   | 34.3   | 7.8     | 11.1    | 5           | 20/40  |
| YT-0353 | 24     | 290    | 49.9   | 34.8   | 9.2     | 11.2    | 5           | 20/40  |
| YT-0354 | 25     | 300    | 51.2   | 36.6   | 9.2     | 12.4    | 5           | 20/40  |
| YT-0355 | 26     | 310    | 53.2   | 37.4   | 9.2     | 12.9    | 5           | 20/40  |
| YT-0356 | 27     | 320    | 55.9   | 39.3   | 9.3     | 12.7    | 5           | 15/30  |
| YT-0357 | 28     | 330    | 56.5   | 40.9   | 9.9     | 13.5    | 5           | 15/30  |
| YT-0358 | 29     | 340    | 60.0   | 42.4   | 10.0    | 13.6    | 5           | 15/30  |
| YT-0359 | 30     | 350    | 60.9   | 43.8   | 10.0    | 14.7    | 5           | 10/20  |
| YT-0360 | 32     | 370    | 64.5   | 46.6   | 11.3    | 14.9    | 5           | 10/20  |

GB Combination spanner  
 D Maulringschlüssel  
 PL Klucz płasko-oczkowy  
 RUS Ключ комбинированный  
 CZ Plochý a očkový klič  
 H Kulcs villás-csillag  
 RO Cheie combinată

F Clé mixte à cliquet  
 I Chiave combinata  
 E Combinada con llave de estrella  
 CN 两用扳手

AS-DRIVE

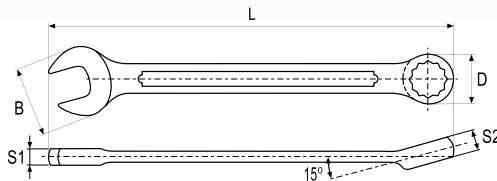

- application: workshop
- head offset: 15°
- surface finish: chromed, satin

- przeznaczenie: warsztat
- kąt odchylenia główek: 15°
- wykończenie powierzchni: chromowana, satynowa

COLOR BOX



| YATO     | Ø (mm) | L (mm) | B (mm) | D (mm) | S1 (mm) | S2 (mm) | PCS packing |    |
|----------|--------|--------|--------|--------|---------|---------|-------------|----|
| YT-00760 | 34     | 425    | 65.2   | 51.0   | 13.0    | 16.0    | 5           | 20 |
| YT-00761 | 36     | 460    | 73.0   | 57.0   | 14.0    | 17.5    | 5           | 15 |
| YT-00762 | 38     | 460    | 73.0   | 57.0   | 14.0    | 17.5    | 5           | 15 |
| YT-00763 | 41     | 500    | 83.0   | 61.5   | 15.0    | 19.0    | 5           | 10 |
| YT-00764 | 46     | 540    | 88.3   | 69.0   | 16.5    | 21.0    | 5           | 10 |

| YATO     | Ø (mm) | L (mm) | B (mm) | D (mm) | S1 (mm) | S2 (mm) | PCS packing |    |
|----------|--------|--------|--------|--------|---------|---------|-------------|----|
| YT-00765 | 48     | 570    | 92.0   | 72.0   | 16.5    | 22.0    | 5           | 10 |
| YT-00766 | 50     | 598    | 96.0   | 74.0   | 18.0    | 23.5    | 2           | 8  |
| YT-00767 | 55     | 620    | 105.6  | 82.4   | 19.0    | 25.0    | 2           | 6  |
| YT-00768 | 60     | 660    | 115.2  | 89.8   | 21.0    | 27.0    | 2           | 6  |
| YT-00769 | 65     | 680    | 124.8  | 97.3   | 23.0    | 29.0    | 2           | 4  |

GB Combination spanner set  
 D Maulringschlüsselsatz  
 PL Komplet kluczy płasko-oczkowych  
 RUS Набор ключей комбинированных

CZ Souprava plochých a očkových kličů  
 H Kulcskészlet, villás-csillag  
 RO Set chei combinate  
 F Set de clés mixtes

I Set chiave combinata  
 E Juego de combinadas con llave de estrella  
 CN 两用扳手手套

POUCH & COLOR BOX

DIN 3113 CrV AS-DRIVE



12 PCS 8, 9, 10, 11, 12, 13, 14, 15, 17, 19, 22, 24 mm

17 PCS 8, 9, 10, 11, 12, 13, 14, 15, 16, 17, 18, 19, 22, 24, 27, 30, 32 mm

25 PCS 6, 7, 8, 9, 10, 11, 12, 13, 14, 15, 16, 17, 18, 19, 20, 21, 22, 23, 24, 25, 26, 27, 28, 30, 32 mm

|         |  |   |
|---------|--|---|
| YATO    |  |   |
| YT-0362 |  | 6 |

|         |  |   |
|---------|--|---|
| YATO    |  |   |
| YT-0363 |  | 3 |

|         |  |   |
|---------|--|---|
| YATO    |  |   |
| YT-0365 |  | 3 |



- GB Combination spanner  
D Maulringschlüssel  
PL Klucz płasko-oczkowy  
RUS Ключ комбинированный  
CZ Plochý a očkový klíč  
H Kulcs villás-csillag  
RO Cheie combinată
- F Clé mixte à cliquet  
I Chiave combinata  
E Combinada con llave de estrella  
CN 两用扳手

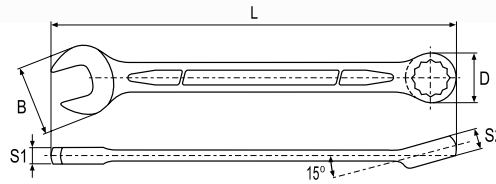

- application: industry
- head offset: 15°
- maximum torque exceeding DIN and ANSI standards by 60%
- surface finish: chromed, satin
- przeznaczenie: przemysł
- kąt odchylenia główki: 15°
- maksymalny moment obrotowy większy o 60% niż w standardach DIN i ANSI
- wykończenie powierzchni: chromowana, satynowa

COLOR BOX



| YATO    | Ø (mm) | L (mm) | B (mm) | D (mm) | S1 (mm) | S2 (mm) | PCS packing: |     |
|---------|--------|--------|--------|--------|---------|---------|--------------|-----|
| YT-0006 | 6      | 109    | 14.4   | 10.3   | 3.7     | 5.2     | 10           | 600 |
| YT-0007 | 7      | 119    | 16.2   | 11.3   | 3.8     | 5.2     | 10           | 600 |
| YT-0008 | 8      | 129    | 18.6   | 12.8   | 4.2     | 5.7     | 10           | 360 |
| YT-0009 | 9      | 139    | 20.7   | 14.1   | 4.3     | 6.4     | 10           | 360 |
| YT-0010 | 10     | 149    | 22.6   | 15.2   | 4.8     | 6.9     | 10           | 360 |
| YT-0011 | 11     | 159    | 24.6   | 16.8   | 5.2     | 7.4     | 10           | 360 |
| YT-0012 | 12     | 169    | 27.1   | 18.0   | 5.3     | 7.9     | 10           | 240 |
| YT-0013 | 13     | 179    | 28.7   | 19.8   | 6.0     | 8.6     | 10           | 240 |
| YT-0014 | 14     | 189    | 31.3   | 20.8   | 6.2     | 8.9     | 10           | 100 |
| YT-0015 | 15     | 199    | 33.2   | 22.3   | 6.6     | 9.2     | 10           | 100 |
| YT-0016 | 16     | 209    | 35.0   | 23.8   | 6.8     | 9.9     | 10           | 100 |
| YT-0017 | 17     | 219    | 37.5   | 25.0   | 7.0     | 10.9    | 10           | 100 |
| YT-0018 | 18     | 229    | 39.5   | 26.6   | 7.8     | 11.4    | 10           | 100 |
| YT-0019 | 19     | 239    | 41.3   | 28.0   | 8.0     | 12.1    | 10           | 100 |
| YT-0020 | 20     | 249    | 44.1   | 29.8   | 8.3     | 12.4    | 10           | 80  |
| YT-0021 | 21     | 259    | 46.1   | 30.8   | 8.6     | 12.7    | 10           | 80  |

| YATO    | Ø (mm) | L (mm) | B (mm) | D (mm) | S1 (mm) | S2 (mm) | PCS packing: |      |
|---------|--------|--------|--------|--------|---------|---------|--------------|------|
| YT-0022 | 22     | 269    | 48.2   | 32.2   | 9.0     | 13.1    | 5            | 40   |
| YT-0023 | 23     | 279    | 49.8   | 33.6   | 9.2     | 13.4    | 5            | 40   |
| YT-0024 | 24     | 289    | 51.4   | 34.3   | 9.6     | 13.4    | 5            | 40   |
| YT-0025 | 25     | 299    | 54.6   | 36.8   | 9.8     | 14.2    | 5            | 40   |
| YT-0026 | 26     | 309    | 56.2   | 37.3   | 10.0    | 14.9    | 5            | 40   |
| YT-0027 | 27     | 319    | 58.7   | 39.6   | 10.4    | 16.4    | 5            | 30   |
| YT-0028 | 28     | 329    | 59.4   | 40.7   | 10.8    | 16.9    | 5            | 30   |
| YT-0030 | 30     | 349    | 63.0   | 43.3   | 11.3    | 18.4    | 5            | 30   |
| YT-0032 | 32     | 369    | 67.3   | 44.8   | 11.8    | 19.4    | 4            | 24   |
| YT-0036 | 36     | 435    | 74.0   | 53.5   | 13.8    | 19.5    | -            | 5/10 |
| YT-0038 | 38     | 445    | 76.0   | 55.0   | 16.3    | 20.3    | -            | 5/10 |
| YT-0041 | 41     | 475    | 83.7   | 61.6   | 16.3    | 20.3    | -            | 2/8  |
| YT-0046 | 46     | 545    | 99.0   | 75.3   | 19.5    | 22.7    | -            | 2/8  |
| YT-0050 | 50     | 545    | 99.5   | 76.0   | 19.5    | 22.7    | -            | 2/8  |
| YT-0055 | 55     | 610    | 110.0  | 80.0   | 19.5    | 22.7    | -            | 2/4  |

- GB Combination spanner set  
D Maulringschlüsselsatz  
PL Komplet kluczy płasko-oczkowych  
RUS Набор ключей комбинированных
- CZ Souprava plochých a očkových klíčů  
H Kulcskészlet, villás-csillag  
RO Set chei combinat  
F Set de clés mixtes
- I Set chiave combinata  
E Juego de combinadas con llave de estrella  
CN 两用扳手组套

POUCH & COLOR BOX



DIN  
3113

CrV  
6140

AS-DRIVE



10  
PCS  
6, 7, 8, 10, 12, 13,  
14, 15, 17, 19 mm

YATO  
YT-0060  
20

12  
PCS  
8, 9, 10, 11, 12, 13, 14,  
15, 17, 19, 22, 24 mm

YATO  
YT-0062  
6



15  
PCS  
6, 7, 8, 10, 11, 12, 13, 14, 15,  
17, 18, 19, 22, 24, 27 mm

YATO  
YT-0065  
8

17  
PCS  
8, 9, 10, 11, 12, 13, 14, 15, 16, 17,  
18, 19, 22, 24, 27, 30, 32 mm

YATO  
YT-0067  
3



25  
PCS  
6, 7, 8, 9, 10, 11, 12, 13, 14,  
15, 16, 17, 18, 19, 20, 21, 22,  
23, 24, 25, 26, 27, 28, 30, 32 mm

YATO  
YT-0075  
3

1

GB Combination spanner  
D Maulringschlüssel  
PL Klucz płasko-oczkowy  
RUS Ключ комбинированный  
CZ Plochy a očkový klíč  
H Kulcs villás-csillag  
RO Cheie combinată

F Clé mixte à cliquet  
I Chiave combinata  
E Combinada con llave de estrella  
CN 两用扳手

COLOR BOX



DIN 3113 CrV 6140 AS-DRIVE

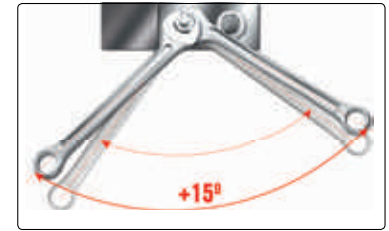
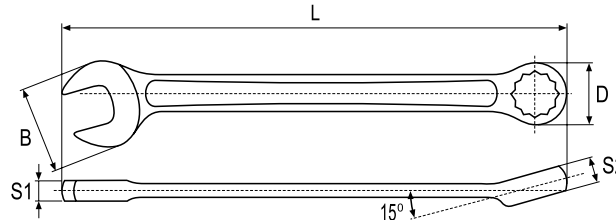

- application: industry
- head offset: 15°
- maximum torque exceeding DIN and ANSI standards by 60%
- surface finish: chromed, satin
- przeznaczenie: przemysł
- kąt odchylenia główki: 15°
- maksymalny moment obrotowy większy o 60% niż w standardach DIN i ANSI
- wykończenie powierzchni: chromowana, satynowa

| YATO    | Ø (mm) | L (mm) | B (mm) | D (mm) | S1 (mm) | S2 (mm) | PCS packing: |     |
|---------|--------|--------|--------|--------|---------|---------|--------------|-----|
| YT-5000 | 6      | 105    | 14.6   | 10.6   | 3.3     | 6.5     | 10           | 600 |
| YT-5001 | 7      | 116    | 16.5   | 11.6   | 3.5     | 6.2     | 10           | 600 |
| YT-5002 | 8      | 125    | 18.4   | 13.0   | 4.0     | 6.9     | 10           | 360 |
| YT-5003 | 9      | 132    | 20.5   | 14.5   | 4.0     | 7.5     | 10           | 360 |
| YT-5005 | 11     | 152    | 24.4   | 16.8   | 4.8     | 8.4     | 10           | 360 |
| YT-5006 | 12     | 160    | 26.1   | 18.3   | 4.9     | 8.4     | 10           | 240 |
| YT-5008 | 14     | 180    | 30.6   | 20.9   | 5.3     | 9.7     | 10           | 100 |
| YT-5009 | 15     | 193    | 33.6   | 22.6   | 5.5     | 10.0    | 10           | 100 |
| YT-5010 | 16     | 200    | 34.4   | 24.5   | 6.0     | 10.8    | 10           | 100 |
| YT-5012 | 18     | 215    | 38.8   | 26.5   | 6.8     | 11.6    | 10           | 100 |
| YT-5014 | 20     | 237    | 43.4   | 30.1   | 7.0     | 12.5    | 10           | 80  |

| YATO    | Ø (mm) | L (mm) | B (mm) | D (mm) | S1 (mm) | S2 (mm) | PCS packing: |    |
|---------|--------|--------|--------|--------|---------|---------|--------------|----|
| YT-5015 | 21     | 243    | 45.2   | 31.1   | 7.3     | 13.1    | 10           | 80 |
| YT-5016 | 22     | 255    | 46.8   | 32.4   | 7.4     | 13.7    | 5            | 40 |
| YT-5017 | 23     | 267    | 49.3   | 34.3   | 7.7     | 13.8    | 5            | 40 |
| YT-5018 | 24     | 271    | 50.5   | 36.1   | 8.2     | 14.4    | 5            | 40 |
| YT-5019 | 25     | 286    | 53.2   | 37.1   | 8.4     | 14.9    | 5            | 40 |
| YT-5020 | 26     | 295    | 54.5   | 38.7   | 8.7     | 15.2    | 5            | 40 |
| YT-5021 | 27     | 305    | 56.7   | 40.0   | 8.7     | 16.5    | 5            | 30 |
| YT-5022 | 28     | 315    | 58.7   | 41.6   | 9.5     | 16.8    | 5            | 30 |
| YT-5023 | 29     | 328    | 60.4   | 42.5   | 9.2     | 17.5    | 5            | 30 |
| YT-5024 | 30     | 340    | 62.4   | 44.7   | 10.4    | 18.7    | 5            | 30 |
| YT-5025 | 32     | 357    | 66.5   | 47.2   | 10.5    | 20.3    | 4            | 24 |

GB Combination spanner  
D Maulringschlüssel  
PL Klucz płasko-oczkowy  
RUS Ключ комбинированный  
CZ Plochy a očkový klíč  
H Kulcs villás-csillag  
RO Cheie combinată

F Clé mixte à cliquet  
I Chiave combinata  
E Combinada con llave de estrella  
CN 两用扳手

S.A.E. DIN 3113 CrV AS-DRIVE

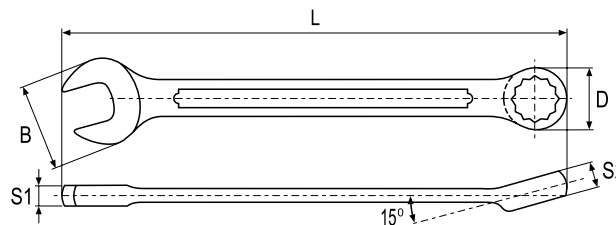

- application: workshop
- head offset: 15°
- surface finish: chromed, satin / mirror
- przeznaczenie: warsztat
- kąt odchylenia główki: 15°
- wykończenie powierzchni: chromowana, satynowa / polerowana

COLOR BOX



| YATO    | Ø                | L (mm) | B (mm) | D (mm) | S1 (mm) | S2 (mm) | PCS packing: |         |
|---------|------------------|--------|--------|--------|---------|---------|--------------|---------|
| YT-4870 | 1/4" (6.3 mm)    | 110    | 13.9   | 10.7   | 4.0     | 4.9     | 10           | 300/600 |
| YT-4871 | 5/16" (7.9 mm)   | 130    | 17.6   | 12.8   | 4.6     | 5.7     | 10           | 180/360 |
| YT-4872 | 3/8" (9.5 mm)    | 150    | 21.5   | 15.5   | 4.8     | 6.1     | 10           | 180/360 |
| YT-4873 | 7/16" (11.1 mm)  | 160    | 23.8   | 17.0   | 5.1     | 6.7     | 10           | 180/360 |
| YT-4874 | 1/2" (12.7 mm)   | 180    | 27.6   | 19.9   | 5.6     | 8.0     | 10           | 120/240 |
| YT-4875 | 9/16" (14.3 mm)  | 190    | 29.6   | 21.6   | 6.1     | 8.1     | 10           | 120/240 |
| YT-4876 | 5/8" (15.9 mm)   | 210    | 33.6   | 23.9   | 6.3     | 9.2     | 10           | 50/100  |
| YT-4877 | 11/16" (17.5 mm) | 230    | 37.8   | 26.3   | 6.7     | 10.8    | 10           | 50/100  |

| YATO    | Ø                 | L (mm) | B (mm) | D (mm) | S1 (mm) | S2 (mm) | PCS packing: |        |
|---------|-------------------|--------|--------|--------|---------|---------|--------------|--------|
| YT-4878 | 3/4" (19.0 mm)    | 240    | 40.1   | 27.9   | 7.2     | 10.6    | 10           | 50/100 |
| YT-4879 | 13/16" (20.6 mm)  | 260    | 43.2   | 31.1   | 7.6     | 10.8    | 10           | 40/80  |
| YT-4880 | 7/8" (22.2 mm)    | 270    | 46.5   | 32.9   | 8.4     | 11.6    | 5            | 20/40  |
| YT-4881 | 15/16" (23.8 mm)  | 290    | 50.2   | 34.9   | 8.7     | 12.0    | 5            | 20/40  |
| YT-4882 | 1" (25.4 mm)      | 300    | 51.9   | 36.2   | 8.8     | 12.7    | 5            | 20/40  |
| YT-4883 | 1-1/16" (27.0 mm) | 320    | 56.0   | 38.9   | 9.3     | 13.6    | 5            | 15/30  |
| YT-4884 | 1-1/8" (28.6 mm)  | 340    | 59.7   | 42.2   | 9.8     | 14.2    | 5            | 15/30  |
| YT-4885 | 1-1/4" (31.8 mm)  | 370    | 65.5   | 46.2   | 10.9    | 15.6    | 5            | 10/20  |



GB Stubby combination spanner  
D Maulringschlüssel  
PL Klucz płasko-oczkowy krótki  
RUS Ключ комбинированный  
CZ Plochý a očkový klíč  
H Kulcs villás-csillag  
RO Cheie combinată  
F Clé mixte courte  
I Chiave combinata corta  
E Combinada con llave de estrella  
CN 两用扳手



COLOR BOX



CrV AS-DRIVE

1

- application: workshop
- head offset: 15°
- surface finish: chromed

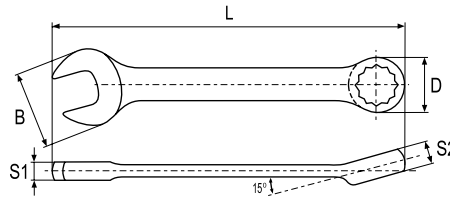

- przeznaczenie: warsztat
- kąt odchylenia główek: 15°
- wykończenie powierzchni: chromowana

| YATO    | Ø (mm) | L (mm) | B (mm) | D (mm) | S1 (mm) | S2 (mm) | PCS packing: |         |
|---------|--------|--------|--------|--------|---------|---------|--------------|---------|
| YT-4901 | 8      | 91     | 19.2   | 13.9   | 5.0     | 6.3     | 10           | 120/240 |
| YT-4902 | 9      | 97     | 21.7   | 16.4   | 5.4     | 6.4     | 10           | 120/240 |
| YT-4903 | 10     | 97     | 21.9   | 16.6   | 5.2     | 6.4     | 10           | 120/240 |
| YT-4904 | 11     | 100    | 23.2   | 18.3   | 5.9     | 7.2     | 10           | 120/240 |
| YT-4905 | 12     | 108    | 27.4   | 20.2   | 6.4     | 7.6     | 10           | 120/240 |
| YT-4906 | 13     | 109    | 27.9   | 20.7   | 6.7     | 7.7     | 10           | 120/240 |

| YATO    | Ø (mm) | L (mm) | B (mm) | D (mm) | S1 (mm) | S2 (mm) | PCS packing: |        |
|---------|--------|--------|--------|--------|---------|---------|--------------|--------|
| YT-4907 | 14     | 115    | 29.3   | 22.1   | 6.1     | 8.3     | 10           | 60/120 |
| YT-4908 | 15     | 120    | 31.2   | 24.0   | 6.8     | 9.6     | 10           | 60/120 |
| YT-4909 | 16     | 121    | 32.0   | 24.3   | 6.8     | 9.6     | 10           | 60/120 |
| YT-4910 | 17     | 128    | 36.6   | 27.1   | 7.4     | 9.9     | 10           | 60/120 |
| YT-4911 | 18     | 127    | 36.2   | 26.8   | 7.4     | 9.9     | 10           | 60/120 |
| YT-4912 | 19     | 135    | 39.2   | 29.5   | 8.8     | 10.8    | 10           | 60/120 |

GB Combination ratchet wrench  
D Ratschenringmaulschlüssel  
PL Klucz płasko-oczkowy z grzechotką  
RUS Ключ комбинированный с трещоткой  
CZ Klíč očkoplochý ráčnový  
H Csillag-villás kulcs racsnis  
RO Cheie combinata cu crichet  
F Clé mixte à cliquet  
I Chiave combinata a cricchetto reversibile  
E Llave combinada fija abierta y carraca  
CN 棘轮两用扳手



72T  
CrV 6140 AS-DRIVE

- application: service
- 72 teeth ratchet
- minimum operation angle: 5°
- surface finish: chromed, mirror
- przeznaczenie: serwis
- grzechotka 72 zęby
- minimalny kąt pracy: 5°
- wykończenie powierzchni: chromowana, polerowana



| YATO     | Ø (mm) | L (mm) | B (mm) | D (mm) | S1 (mm) | S2 (mm) | PCS packing: |        |
|----------|--------|--------|--------|--------|---------|---------|--------------|--------|
| YT-01906 | 6      | 120    | 14.7   | 18.0   | 4.0     | 6.5     | 10           | 50/100 |
| YT-01907 | 7      | 130    | 16.2   | 18.0   | 4.3     | 7.0     | 10           | 50/100 |
| YT-01908 | 8      | 141    | 17.6   | 18.2   | 4.8     | 7.2     | 10           | 50/100 |
| YT-01909 | 9      | 151    | 19.4   | 20.4   | 4.8     | 7.4     | 10           | 50/100 |
| YT-0191  | 10     | 160    | 22.1   | 22.2   | 6.0     | 7.8     | 10           | 50/100 |
| YT-0192  | 11     | 165    | 24.7   | 24.2   | 6.6     | 8.5     | 10           | 50/100 |
| YT-0193  | 12     | 170    | 26.4   | 25.5   | 6.7     | 8.9     | 10           | 50/100 |
| YT-0194  | 13     | 180    | 27.5   | 26.7   | 6.6     | 9.2     | 10           | 50/100 |
| YT-0195  | 14     | 190    | 30.8   | 29.0   | 7.4     | 9.4     | 10           | 50/100 |
| YT-0196  | 15     | 200    | 32.9   | 30.8   | 7.7     | 10.1    | 10           | 50/100 |
| YT-0197  | 16     | 210    | 34.3   | 31.5   | 7.8     | 10.3    | 10           | 50/100 |

| YATO    | Ø (mm) | L (mm) | B (mm) | D (mm) | S1 (mm) | S2 (mm) | PCS packing: |        |
|---------|--------|--------|--------|--------|---------|---------|--------------|--------|
| YT-0198 | 17     | 225    | 36.8   | 33.6   | 8.4     | 10.6    | 10           | 50/100 |
| YT-0199 | 18     | 235    | 39.2   | 35.6   | 9.1     | 10.8    | 10           | 50/100 |
| YT-0200 | 19     | 245    | 40.1   | 37.3   | 9.5     | 11.3    | 10           | 50/100 |
| YT-0189 | 21     | 290    | 45.2   | 43.0   | 9.9     | 13.3    | 6            | 30/60  |
| YT-0201 | 22     | 290    | 45.6   | 44.2   | 10.5    | 13.4    | 6            | 24/48  |
| YT-0202 | 24     | 335    | 52.8   | 50.0   | 11.3    | 14.5    | 6            | 48     |
| YT-0203 | 25     | 335    | 52.0   | 47.4   | 10.2    | 14.3    | 6            | 30     |
| YT-0204 | 27     | 355    | 55.6   | 52.7   | 10.9    | 15.7    | 6            | 30     |
| YT-0205 | 30     | 400    | 62.5   | 57.7   | 12.2    | 17.1    | 6            | 24     |
| YT-0206 | 32     | 420    | 65.0   | 61.7   | 13.2    | 17.9    | 6            | 24     |

GB Combination ratchet wrench set  
D Knarrenringmaulschlüssel-satz  
PL Komplet kluczy płasko-oczkowych z grzechotką  
RUS Набор комбинированных ключей с трещоткой  
CZ Klíče ráčnové sada  
H Racsnis csillag-villás kulcs készlet  
RO Set chei combinate  
F Set de clés mixte à cliquet  
I Set chiavi combinate a cricchetto  
E Juego de llaves planas con matraca  
CN 扳手组套



7 PCS CrV 6140 72T AS-DRIVE

10, 12, 13, 14, 15, 17, 19 mm

PLASTIC HANGER

| YATO    | PCS packing: |  |
|---------|--------------|--|
| YT-0208 | 10/20        |  |

1

- GB Combination ratchet wrench
- D Ratschenringmaulschlüssel
- PL Klucz płasko-oczkowy z grzechotką
- RUS Ключ комбинированный с трещоткой
- CZ Kľúč očkoploché rúčnový
- H Csillag-villás kulcs racsnis
- RO Cheie combinata cu crichet
- F Clé mixte à cliquet
- I Chiave combinata a cricchetto reversibile
- E Llave combinada fija abierta y carraca
- CN 棘轮两用扳手

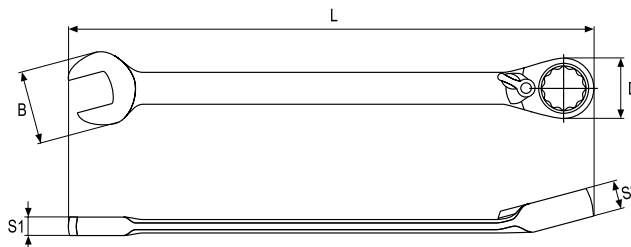

| YATO    | Ø (mm) | L (mm) | B (mm) | D (mm) | S1 (mm) | S2 (mm) | PCS packing |        |
|---------|--------|--------|--------|--------|---------|---------|-------------|--------|
| YT-1651 | 8      | 140    | 17.5   | 19.0   | 6.0     | 7.2     | 10          | 50/100 |
| YT-1652 | 9      | 150    | 19.8   | 20.7   | 6.4     | 7.5     | 10          | 50/100 |
| YT-1653 | 10     | 160    | 22.1   | 23.1   | 6.4     | 7.9     | 10          | 50/100 |
| YT-1654 | 11     | 165    | 23.9   | 25.0   | 6.6     | 8.4     | 10          | 50/100 |
| YT-1655 | 12     | 170    | 27.1   | 26.0   | 6.5     | 8.9     | 10          | 50/100 |
| YT-1656 | 13     | 180    | 27.9   | 27.6   | 7.1     | 9.1     | 10          | 50/100 |
| YT-1657 | 14     | 190    | 31.6   | 28.3   | 7.3     | 9.5     | 10          | 50/100 |
| YT-1658 | 15     | 200    | 32.8   | 31.4   | 8.1     | 9.8     | 10          | 50/100 |
| YT-1659 | 16     | 210    | 33.9   | 32.9   | 8.4     | 10.3    | 10          | 50/100 |
| YT-1660 | 17     | 225    | 38.0   | 34.5   | 8.7     | 10.5    | 10          | 50/100 |
| YT-1661 | 18     | 235    | 39.8   | 36.9   | 9.3     | 10.7    | 10          | 50/100 |
| YT-1662 | 19     | 245    | 41.8   | 38.3   | 9.5     | 11.3    | 10          | 50/100 |

| YATO    | Ø (mm) | L (mm) | B (mm) | D (mm) | S1 (mm) | S2 (mm) | PCS packing |       |
|---------|--------|--------|--------|--------|---------|---------|-------------|-------|
| YT-1663 | 20     | 245    | 41.9   | 38.1   | 9.7     | 11.4    | 6           | 30/60 |
| YT-1664 | 21     | 290    | 44.9   | 43.0   | 9.8     | 13.6    | 6           | 30/60 |
| YT-1665 | 22     | 290    | 44.8   | 43.8   | 10.0    | 13.6    | 6           | 30/60 |
| YT-1666 | 23     | 290    | 44.9   | 43.3   | 10.3    | 13.7    | 6           | 24/48 |
| YT-1667 | 24     | 330    | 52.0   | 49.4   | 10.2    | 14.5    | 6           | 24/48 |
| YT-1668 | 25     | 330    | 53.0   | 49.6   | 10.6    | 14.7    | 6           | 24/48 |
| YT-1669 | 26     | 360    | 56.3   | 53.6   | 12.1    | 15.7    | 6           | 30    |
| YT-1670 | 27     | 360    | 55.6   | 52.9   | 12.2    | 16.1    | 6           | 30    |
| YT-1671 | 28     | 360    | 56.1   | 53.6   | 12.6    | 16.0    | 6           | 24    |
| YT-1672 | 30     | 400    | 62.1   | 58.0   | 11.9    | 17.2    | 6           | 24    |
| YT-1673 | 32     | 420    | 64.1   | 62.0   | 12.9    | 17.7    | 6           | 24    |

- GB Combination ratchet wrench
- D Ratschenringmaulschlüssel
- PL Klucz płasko-oczkowy z grzechotką
- RUS Ключ комбинированный с трещоткой
- CZ Kľúč očkoploché rúčnový
- H Csillag-villás kulcs racsnis
- RO Cheie combinata cu crichet
- F Clé mixte à cliquet
- I Chiave combinata a cricchetto reversibile
- E Llave combinada fija abierta y carraca
- CN 棘轮两用扳手

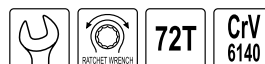

- application: industry
- 72 teeth ratchet
- minimum operation angle: 5°
- NON-SLIP system
- allows to unscrew 70% damaged hex screws
- surface finish: chromed, satin
- przeznaczenie: przemysł
- grzechotka 72 zęby
- minimalny kąt pracy: 5°
- system NON-SLIP
- umożliwia odkręcanie śrub sześciokątnych zniszczonych w 70%
- wykończenie powierzchni: chromowana, satynowa



| YATO    | Ø (mm) | L (mm) | B (mm) | D (mm) | S1 (mm) | S2 (mm) |        |
|---------|--------|--------|--------|--------|---------|---------|--------|
| YT-0256 | 11     | 163    | 22.8   | 22.1   | 6.0     | 8.5     | 10/100 |



GB Rapid combination ratchet wrench  
D Ratschenringmaulschlüssel  
PL Klucz „szybki” z grzechotką  
RUS Ключ комбинированный с трещоткой  
CZ Klíč očkoplochý ráčnový  
H Csillag-villás kulcs racsnis  
RO Cheie combinată cu crichet  
F Clé mixte à cliquet  
I Chiave combinata a cricchetto veloce  
E Llave combinada fija abierta y carraca  
CN 棘轮两用扳手

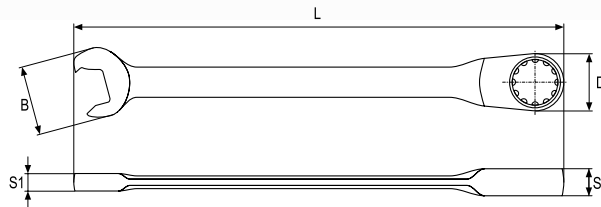
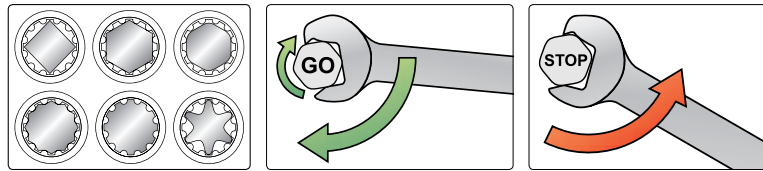

PLASTIC HANGER

- application: industry
- 72 teeth ratchet
- minimum operation angle: 5°
- spline profile serves for 5 types of nuts
- surface finish: chromed, mirror
- przeznaczenie: przemysł
- grzechotka 72 zęby
- minimalny kąt pracy: 5°
- profil Spline – obsługuje 5 rodzajów nakrętek
- wykończenie powierzchni: chromowana, polerowana

| YATO    | Ø (mm) | L (mm) | B (mm) | D (mm) | S1 (mm) | S2 (mm) | PCS    |
|---------|--------|--------|--------|--------|---------|---------|--------|
| YT-0156 | 9      | 150    | 16.65  | 19.40  | 4.65    | 7.28    | 10/100 |
| YT-0158 | 11     | 165    | 20.32  | 21.55  | 5.70    | 8.20    | 10/100 |
| YT-0159 | 12     | 173    | 22.47  | 23.24  | 6.00    | 8.20    | 10/100 |

| YATO    | Ø (mm) | L (mm) | B (mm) | D (mm) | S1 (mm) | S2 (mm) | PCS    |
|---------|--------|--------|--------|--------|---------|---------|--------|
| YT-0162 | 15     | 202    | 27.80  | 27.55  | 7.30    | 8.20    | 10/100 |
| YT-0163 | 16     | 215    | 30.20  | 28.55  | 7.55    | 9.92    | 10/100 |

GB Flexible ratchet combination wrench  
D Ratschenringmaulschlüssel  
PL Klucz płasko-oczkowy z grzechotką i przegubem  
RUS Ключ комбинированный с трещоткой  
CZ Klíč očkoplochý ráčnový  
H Csillag-villás kulcs racsnis  
RO Cheie combinată cu crichet  
F Clé mixte à cliquet tête articulée  
I Chiave combinata a cricchetto testa mobile  
E Llave combinada fija abierta y carraca  
CN 活头棘轮两用扳手

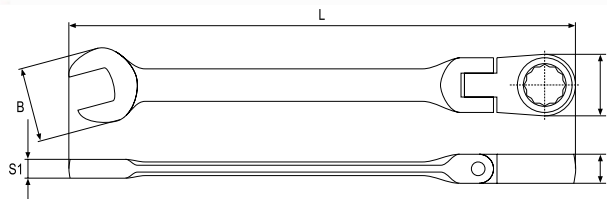

COLOR BOX

PLASTIC HANGER

PCS packing:



| YATO    | Ø (mm) | L (mm) | B (mm) | D (mm) | S1 (mm) | S2 (mm) | PCS packing: |
|---------|--------|--------|--------|--------|---------|---------|--------------|
| YT-1674 | 8      | 140    | 18.0   | 19.6   | 6.3     | 7.3     | 10 50/100    |
| YT-1675 | 9      | 145    | 19.7   | 21.1   | 4.7     | 7.6     | 10 50/100    |
| YT-1676 | 10     | 160    | 22.8   | 23.2   | 6.3     | 7.8     | 10 50/100    |
| YT-1677 | 11     | 160    | 24.0   | 24.7   | 5.4     | 8.5     | 10 50/100    |
| YT-1678 | 12     | 170    | 26.4   | 26.7   | 6.8     | 8.8     | 10 50/100    |
| YT-1679 | 13     | 180    | 28.4   | 27.3   | 7.2     | 9.1     | 10 50/100    |
| YT-1680 | 14     | 185    | 29.5   | 28.7   | 6.8     | 9.4     | 10 50/100    |
| YT-1681 | 15     | 195    | 32.9   | 30.8   | 7.2     | 9.8     | 10 50/100    |
| YT-1682 | 16     | 210    | 34.4   | 33.3   | 7.6     | 10.3    | 10 50/100    |
| YT-1683 | 17     | 230    | 36.7   | 35.7   | 8.3     | 10.5    | 10 50/100    |
| YT-1684 | 18     | 235    | 39.0   | 35.9   | 8.0     | 10.8    | 10 50/100    |

| YATO    | Ø (mm) | L (mm) | B (mm) | D (mm) | S1 (mm) | S2 (mm) | PCS packing: |
|---------|--------|--------|--------|--------|---------|---------|--------------|
| YT-1685 | 19     | 245    | 40.8   | 37.6   | 9.5     | 11.2    | 10 50/100    |
| YT-1686 | 20     | 245    | 40.9   | 38.2   | 8.8     | 11.1    | 6 30/60      |
| YT-1687 | 21     | 290    | 45.0   | 42.8   | 9.8     | 13.6    | 6 30/60      |
| YT-1688 | 22     | 290    | 45.2   | 42.7   | 9.8     | 13.5    | 6 30/60      |
| YT-1689 | 23     | 290    | 45.3   | 42.8   | 9.6     | 13.6    | 6 24/48      |
| YT-1690 | 24     | 330    | 51.3   | 48.7   | 10.4    | 14.5    | 6 24/48      |
| YT-1691 | 25     | 330    | 51.4   | 48.4   | 10.6    | 14.5    | 6 24/48      |
| YT-1692 | 26     | 360    | 56.6   | 53.6   | 11.6    | 15.7    | 6 30         |
| YT-1694 | 28     | 360    | 56.4   | 53.5   | 11.0    | 15.8    | 6 24         |
| YT-1696 | 32     | 430    | 64.7   | 63.3   | 12.8    | 17.8    | 6 24         |

GB Flexible ratchet combination wrench  
D Ratschenringmaulschlüssel  
PL Klucz płasko-oczkowy z grzechotką i przegubem  
RUS Ключ комбинированный с трещоткой  
CZ Klíč očkoplochý ráčnový  
H Csillag-villás kulcs racsnis  
RO Cheie combinată cu crichet  
F Clé mixte à cliquet tête articulée  
I Chiave combinata a cricchetto testa mobile  
E Llave combinada fija abierta y carraca  
CN 活头棘轮两用扳手

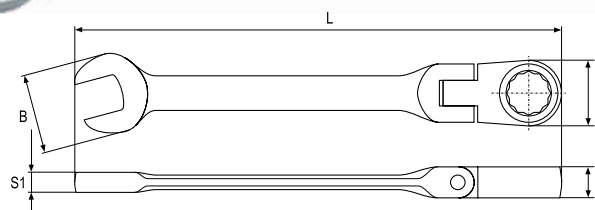
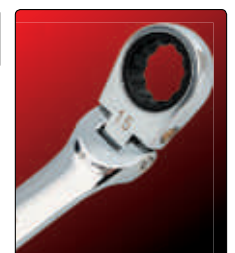
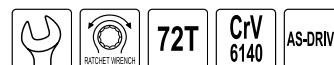

PLASTIC HANGER

- application: industry
- 72 teeth ratchet
- minimum operation angle: 5°
- articulated joint for ring head
- surface finish: chromed, mirror
- przeznaczenie: przemysł
- grzechotka 72 zęby
- minimalny kąt pracy: 5°
- przegub przy główce oczkowej
- wykończenie powierzchni: chromowana, polerowana

| YATO    | Ø (mm) | L (mm) | B (mm) | D (mm) | S1 (mm) | S2 (mm) | PCS    |
|---------|--------|--------|--------|--------|---------|---------|--------|
| YT-0272 | 11     | 139    | 22.8   | 22.0   | 6.0     | 8.4     | 10/100 |
| YT-0276 | 15     | 167    | 31.6   | 27.7   | 7.4     | 8.4     | 10/100 |

| YATO    | Ø (mm) | L (mm) | B (mm) | D (mm) | S1 (mm) | S2 (mm) | PCS    |
|---------|--------|--------|--------|--------|---------|---------|--------|
| YT-0279 | 18     | 201    | 39.0   | 31.7   | 8.4     | 11.5    | 10/100 |
| YT-0280 | 19     | 213    | 39.7   | 34.2   | 8.5     | 11.5    | 10/100 |

1

- GB Double open end spanner
- D Doppelmaulschlüssel
- PL Klucz płaski
- RUS Ключ рожковый
- CZ Plochý klíč
- H Villáskulcs
- RO Cheie fixă
- F Clé plate
- I Chiave piatta
- E Llave fija
- CN 双头呆扳手

DIN 3110 CrV

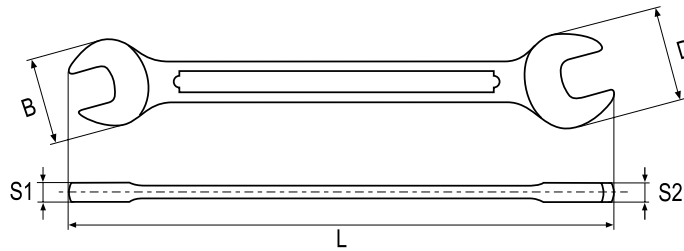

- surface finish:  
chromed, satin / mirror
- wykończenie powierzchni:  
chromowana, satynowa / polerowana



| YATO    | Ø (mm) | L (mm) | B (mm) | D (mm) | S1 (mm) | S2 (mm) | PCS packing |         |
|---------|--------|--------|--------|--------|---------|---------|-------------|---------|
| YT-0367 | 6x7    | 120    | 15.1   | 16.8   | 3.5     | 3.6     | 10          | 360/720 |
| YT-0368 | 8x9    | 140    | 18.7   | 20.8   | 3.7     | 3.6     | 10          | 180/360 |
| YT-0369 | 10x11  | 155    | 22.4   | 25.5   | 4.6     | 4.6     | 10          | 150/300 |
| YT-0332 | 10x13  | 170    | 22.5   | 29.3   | 4.6     | 5.3     | 10          | 150/300 |
| YT-0370 | 12x13  | 170    | 27.1   | 29.3   | 4.9     | 5.3     | 10          | 80/160  |
| YT-0333 | 13x17  | 180    | 29.3   | 37.5   | 5.3     | 6.3     | 10          | 50/100  |
| YT-0371 | 14x15  | 180    | 31.0   | 33.0   | 5.3     | 5.4     | 10          | 80/160  |
| YT-0372 | 16x17  | 200    | 34.9   | 37.5   | 6.5     | 6.3     | 10          | 50/100  |

| YATO    | Ø (mm) | L (mm) | B (mm) | D (mm) | S1 (mm) | S2 (mm) | PCS packing |        |
|---------|--------|--------|--------|--------|---------|---------|-------------|--------|
| YT-0334 | 17x19  | 220    | 37.5   | 38.7   | 6.3     | 6.3     | 10          | 50/100 |
| YT-0373 | 18x19  | 220    | 38.7   | 41.0   | 6.6     | 6.3     | 10          | 50/100 |
| YT-0374 | 20x22  | 230    | 42.1   | 46.8   | 7.1     | 6.8     | 10          | 30/60  |
| YT-0375 | 21x23  | 245    | 44.4   | 48.6   | 7.3     | 6.9     | 10          | 30/60  |
| YT-0376 | 24x27  | 260    | 51.6   | 56.9   | 8.1     | 8.1     | 5           | 20/40  |
| YT-0377 | 25x28  | 270    | 52.3   | 57.9   | 8.4     | 8.3     | 5           | 20/40  |
| YT-0378 | 30x32  | 295    | 61.4   | 65.1   | 8.0     | 8.6     | 5           | 15/30  |

- GB Double open end spanner set
- D Doppelmaulschlüsselsatz
- PL Komplet kluczy płaskich
- RUS Набор рожковых ключей
- CZ Souprava plochých klíčů
- H Kulcskészlet, villás
- RO Set chei fixe
- F Set de clés à tête fendue
- I Set di chiavi piatte
- E Juego de llaves fijas
- CN 双头呆扳手组套



DIN 3110

CrV



**10 PCS** 6x7, 8x9, 10x11, 12x13, 14x15, 16x17, 18x19, 20x22, 21x23, 24x27 mm

**12 PCS** 6x7, 8x9, 10x11, 12x13, 14x15, 16x17, 18x19, 20x22, 21x23, 24x27, 25x28, 30x32 mm

|         |   |  |
|---------|---|--|
| YATO    |   |  |
| YT-0380 | 6 |  |

|         |   |  |
|---------|---|--|
| YATO    |   |  |
| YT-0381 | 8 |  |



- GB Double open end spanner
- D Doppelmaulschlüssel
- PL Klucz płaski
- RUS Ключ рожковый
- CZ Plochý klíč
- H Villáskulcs
- RO Cheie fixă
- F Clé plate
- I Chiave piatta
- E Llave fija
- CN 双头呆扳手

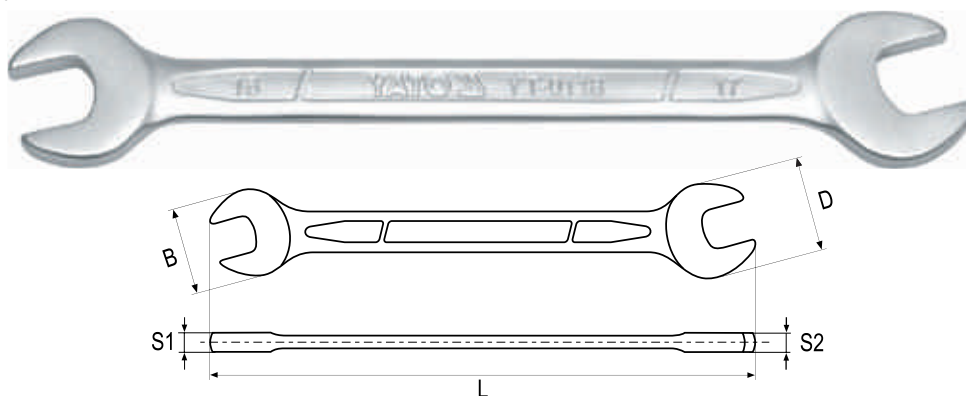

- surface finish:  
chromed, satin
- wykończenie powierzchni:  
chromowana, satynowa



| YATO    | Ø (mm) | L (mm) | B (mm) | D (mm) | S1 (mm) | S2 (mm) | PCS packing |     |
|---------|--------|--------|--------|--------|---------|---------|-------------|-----|
| YT-0107 | 6x7    | 128    | 15.5   | 17.5   | 3.8     | 3.8     | 10          | 600 |
| YT-0109 | 8x9    | 146    | 19.4   | 21.4   | 4.3     | 4.3     | 10          | 360 |
| YT-0110 | 8x10   | 146    | 19.4   | 21.4   | 4.3     | 4.3     | 10          | 360 |
| YT-0111 | 10x11  | 162    | 23.5   | 25.7   | 5.0     | 5.0     | 10          | 360 |
| YT-0112 | 10x13  | 175    | 27.7   | 30.2   | 5.3     | 5.3     | 10          | 120 |
| YT-0113 | 12x13  | 175    | 27.7   | 30.2   | 5.3     | 5.3     | 10          | 120 |
| YT-0115 | 14x15  | 191    | 31.7   | 33.7   | 5.8     | 5.8     | 10          | 120 |
| YT-0117 | 13x17  | 195    | 31.7   | 38.7   | 6.2     | 6.2     | 10          | 120 |
| YT-0118 | 16x17  | 212    | 36.2   | 38.2   | 6.3     | 6.3     | 10          | 100 |

| YATO    | Ø (mm) | L (mm) | B (mm) | D (mm) | S1 (mm) | S2 (mm) | PCS packing |     |
|---------|--------|--------|--------|--------|---------|---------|-------------|-----|
| YT-0119 | 17x19  | 224    | 40.2   | 42.2   | 6.8     | 6.8     | 10          | 100 |
| YT-0120 | 18x19  | 224    | 40.2   | 42.2   | 6.8     | 6.8     | 10          | 100 |
| YT-0122 | 19x22  | 237    | 44.2   | 48.2   | 7.5     | 7.5     | 10          | 60  |
| YT-0123 | 20x22  | 237    | 44.2   | 48.2   | 7.5     | 7.5     | 10          | 60  |
| YT-0125 | 21x23  | 247    | 46.2   | 50.2   | 7.8     | 7.8     | 10          | 60  |
| YT-0127 | 24x27  | 268    | 53.2   | 57.7   | 8.4     | 8.4     | 5           | 40  |
| YT-0128 | 25x28  | 268    | 53.2   | 57.7   | 8.4     | 8.4     | 5           | 40  |
| YT-0132 | 30x32  | 295    | 64.2   | 68.2   | 9.4     | 9.4     | 5           | 40  |

- GB Double open end spanner set
- CZ Souprava plochých klíčů
- I Set di chiavi piatte
- D Doppelmaulschlüsselsatz
- H Kulcskészlet, villás
- E Juego de llaves fijas
- PL Komplet kluczy płaskich
- RO Set chei fixe
- CN 双头呆扳手组套
- RUS Набор рожковых ключей
- F Set de clés à tête fendue



**10 PCS** 6x7, 8x9, 10x11, 12x13, 14x15, 16x17, 18x19, 20x22, 21x23, 24x27 mm

**12 PCS** 6x7, 8x9, 10x11, 12x13, 14x15, 16x17, 18x19, 20x22, 21x23, 24x27, 25x28, 30x32 mm

| YATO    |   |
|---------|---|
| YT-0150 | 6 |

| YATO    |   |
|---------|---|
| YT-0152 | 8 |

- GB Double open end spanner
- D Doppelmaulschlüssel
- PL Klucz płaski
- RUS Ключ рожковый
- CZ Plochý klíč
- H Villáskulcs
- RO Cheie fixă
- F Clé plate
- I Chiave piatta
- E Llave fija
- CN 双头呆扳手

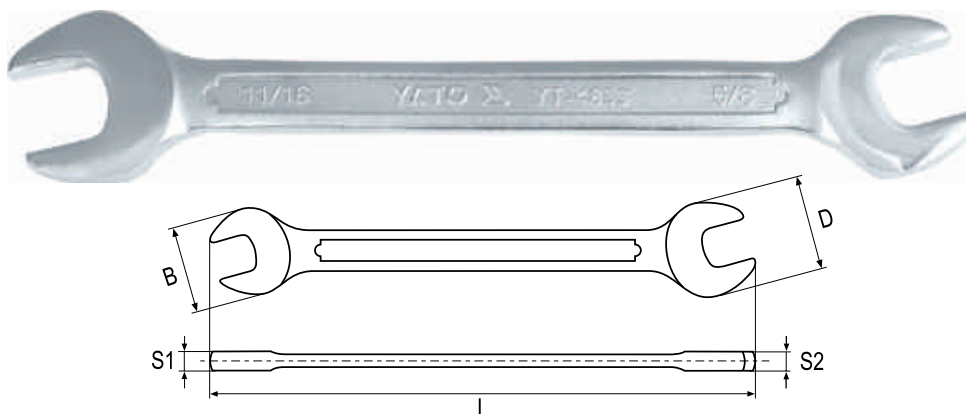

- surface finish:  
chromed, satin / mirror
- wykończenie powierzchni:  
chromowana, satynowa / polerowana



| YATO    | Ø                                 | L (mm) | B (mm) | D (mm) | S1 (mm) | S2 (mm) | PCS packing |         |
|---------|-----------------------------------|--------|--------|--------|---------|---------|-------------|---------|
| YT-4830 | 1/4" (6.3 mm) x 5/16" (7.9 mm)    | 120    | 14.8   | 17.2   | 3.9     | 3.9     | 10          | 150/300 |
| YT-4831 | 3/8" (9.5 mm) x 7/16" (11.1 mm)   | 155    | 22.0   | 25.1   | 4.8     | 4.8     | 10          | 150/300 |
| YT-4832 | 1/2" (12.7 mm) x 9/16" (14.3 mm)  | 185    | 31.2   | 33.4   | 5.8     | 5.8     | 10          | 80/160  |
| YT-4833 | 5/8" (15.9 mm) x 11/16" (17.5 mm) | 200    | 34.6   | 37.2   | 6.0     | 6.1     | 10          | 50/100  |

| YATO    | Ø                                   | L (mm) | B (mm) | D (mm) | S1 (mm) | S2 (mm) | PCS packing |        |
|---------|-------------------------------------|--------|--------|--------|---------|---------|-------------|--------|
| YT-4834 | 11/16" (17.5 mm) x 3/4" (19.0 mm)   | 220    | 38.7   | 41.2   | 7.0     | 7.0     | 10          | 50/100 |
| YT-4835 | 13/16" (20.6 mm) x 7/8" (22.2 mm)   | 235    | 42.7   | 47.0   | 7.0     | 7.0     | 10          | 20/40  |
| YT-4836 | 15/16" (23.8 mm) x 1" (25.4 mm)     | 260    | 51.5   | 56.5   | 8.3     | 8.4     | 5           | 10     |
| YT-4837 | 1-1/8" (28.6 mm) x 1-1/4" (31.8 mm) | 295    | 62.6   | 66.2   | 8.6     | 8.7     | 5           | 10     |

1

- GB Double ratchet spanner  
 D Ringschlüsselsatz  
 PL Klucz oczkowy z grzechotką  
 RUS Ключ накидной  
 CZ Očkové klíč  
 H Csillagkulcs
- RO Cheie inelare  
 F Clé à œil à cliquet  
 I Chiave a cricchetto  
 E Llave de anillo  
 CN 双头梅花棘轮扳手



CrV  
6140

72T



| YATO    | Ø (mm) | L (mm) | D1 (mm) | D2 (mm) | S1 (mm) | S2 (mm) | PCS packing | Box     |
|---------|--------|--------|---------|---------|---------|---------|-------------|---------|
| YT-5030 | 8x9    | 125    | 18.4    | 20.2    | 7.2     | 7.5     | 5           | 100/200 |
| YT-5031 | 10x11  | 150    | 21.9    | 23.9    | 8.0     | 8.5     | 5           | 100/200 |
| YT-5033 | 14x15  | 190    | 27.7    | 29.6    | 9.5     | 9.8     | 5           | 50/100  |

- GB Double ratchet spanner set  
 D Ringschlüsselsatz  
 PL Klucze oczkowe z grzechotką  
 RUS Набор ключей накидных  
 CZ Očkové klíče  
 H Csillagkulcs készlet
- RO Set chei inelare  
 F Set de clés à œil à cliquet  
 I Set chiavi a cricchetto  
 E Llaves de anillo  
 CN 双头梅花棘轮扳手组套

5  
PCS



CrV  
6140

72T



PLASTIC HANGER



8x9, 10x11, 12x13, 14x15, 17x19 mm

| YATO    | Box   |
|---------|-------|
| YT-5038 | 10/30 |

- GB Bi-hexagonal ring spanner  
 D Doppelringschlüssel  
 PL Klucz oczkowy odgięty  
 RUS Ключ накидной изогнутый  
 CZ Očkový klíč ohnutý  
 H Hajlítottszerű csillagkulcs  
 RO Cheie inelaro-curbată  
 F Clé contre-coudée  
 I Chiave poligonale doppio piegato  
 E Llave de estrella  
 CN 双头高颈梅花扳手

DIN  
838

CrV

AS-DRIVE

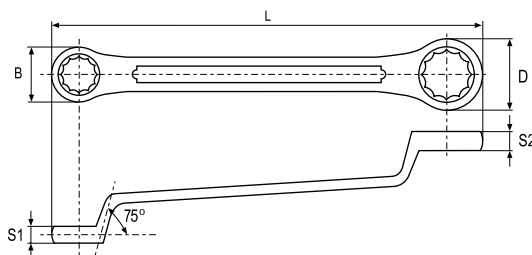

- application: industry
- surface finish: chromed, satin / mirror
- przeznaczenie: przemysł
- wykończenie powierzchni: chromowana, satynowa / polerowana



COLOR BOX

| YATO    | Ø (mm) | L (mm) | B (mm) | D (mm) | S1 (mm) | S2 (mm) | PCS packing | Box     |
|---------|--------|--------|--------|--------|---------|---------|-------------|---------|
| YT-0383 | 6x7    | 165    | 11.0   | 12.7   | 5.4     | 5.5     | 10          | 200/400 |
| YT-0384 | 8x9    | 185    | 13.9   | 15.5   | 6.8     | 7.2     | 10          | 100/200 |
| YT-0385 | 10x11  | 200    | 16.3   | 17.6   | 6.8     | 7.2     | 10          | 100/200 |
| YT-0386 | 12x13  | 220    | 19.6   | 21.5   | 7.2     | 7.7     | 10          | 60/120  |
| YT-0387 | 14x15  | 230    | 23.6   | 21.9   | 8.9     | 9.1     | 10          | 50/100  |
| YT-0388 | 16x17  | 255    | 24.6   | 26.4   | 8.6     | 9.3     | 10          | 30/60   |

| YATO    | Ø (mm) | L (mm) | B (mm) | D (mm) | S1 (mm) | S2 (mm) | PCS packing | Box   |
|---------|--------|--------|--------|--------|---------|---------|-------------|-------|
| YT-0389 | 18x19  | 270    | 27.5   | 28.8   | 10.5    | 10.2    | 5           | 25/50 |
| YT-0390 | 20x22  | 290    | 30.9   | 33.4   | 10.5    | 11.4    | 5           | 20/40 |
| YT-0391 | 21x23  | 310    | 31.9   | 34.4   | 11.8    | 12.4    | 5           | 20/40 |
| YT-0392 | 24x27  | 330    | 36.2   | 40.6   | 11.5    | 13.2    | 5           | 20/40 |
| YT-0394 | 30x32  | 390    | 44.0   | 47.1   | 13.8    | 14.9    | 3           | 15/30 |



GB Bi-hexagonal ring spanner set  
D Doppelringschlüsselsatz  
PL Komplet kluczy oczkowych odgiętych  
RUS Набор ключей накидных изогнутых

CZ Klíče očkové vyhnuté sada  
H Csillagkulcs készlet  
RO Set chei inelare cu cot  
F Set de clés contre-coudées

I Set chiavi poligonali doppie piegate  
E Juego de llaves de estrella acodadas  
CN 双头高颈梅花扳手组套

POUCH  
& COLOR  
BOX



DIN  
838

CrV

AS-DRIVE



**8**  
PCS 6x7, 8x9, 10x11, 12x13, 14x15,  
16x17, 18x19, 20x22 mm

**YATO**  
YT-0396

6

**12**  
PCS 6x7, 8x9, 10x11, 12x13, 14x15,  
16x17, 18x19, 20x22, 21x23, 24x27,  
25x28, 30x32 mm

**YATO**  
YT-0398

4

GB Bi-hexagonal ring spanner  
D Doppelringschlüssel  
PL Klucz oczkowy odgięty  
RUS Ключ накидной изогнутый  
CZ Očkový klíč ohnutý  
H Hajlítotszárú csillagkulcs  
RO Cheie inelaro-curbată  
F Clé contre-coudée  
I Chiave poligonale  
doppio piegato  
E Llave de estrella  
CN 双头高颈梅花扳手

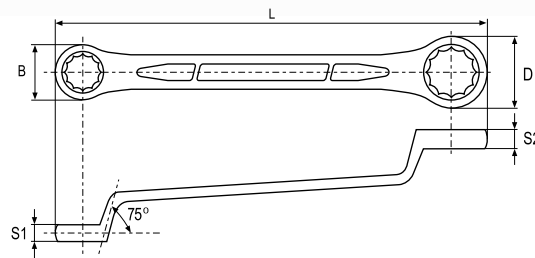

- application: industry
- surface finish: chromed, satin
- przeznaczenie: przemysł
- wykończenie powierzchni: chromowana, satynowa

COLOR BOX



| YATO     | Ø (mm) | L (mm) | B (mm) | D (mm) | S1 (mm) | S2 (mm) | PCS<br>packing: |    |
|----------|--------|--------|--------|--------|---------|---------|-----------------|----|
| YT-02330 | 32x36  | 408    | 52     | 46     | 17.5    | 17.5    | 5               | 20 |
| YT-02331 | 36x41  | 448    | 58     | 52     | 18.0    | 18.0    | 5               | 20 |
| YT-02332 | 41x46  | 483    | 65     | 58     | 18.5    | 18.5    | 5               | 15 |

| YATO     | Ø (mm) | L (mm) | B (mm) | D (mm) | S1 (mm) | S2 (mm) | PCS<br>packing: |    |
|----------|--------|--------|--------|--------|---------|---------|-----------------|----|
| YT-02333 | 46x50  | 495    | 71     | 65     | 19.0    | 19.0    | 5               | 10 |
| YT-02334 | 50x55  | 538    | 78     | 71     | 19.5    | 19.5    | 5               | 10 |

GB Bi-hexagonal ring spanner  
D Doppelringschlüssel  
PL Klucz oczkowy odgięty  
RUS Ключ накидной изогнутый  
CZ Očkový klíč ohnutý  
H Hajlítotszárú csillagkulcs  
RO Cheie inelaro-curbată  
F Clé contre-coudée  
I Chiave poligonale  
doppio piegato  
E Llave de estrella  
CN 双头高颈梅花扳手

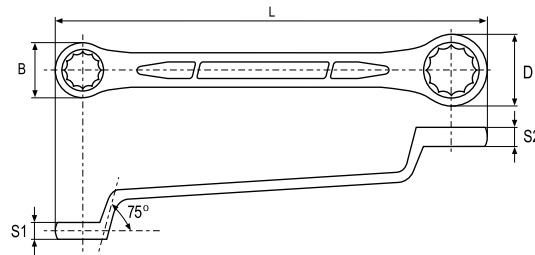

- application: industry
- maximum torque exceeding DIN and ANSI standards by 60%
- surface finish: chromed, satin
- przeznaczenie: przemysł
- maksymalny moment obrotowy większy o 60% niż w standardach DIN i ANSI
- wykończenie powierzchni: chromowana, satynowa

DIN  
838

CrV  
6140

AS-DRIVE

COLOR BOX



| YATO    | Ø (mm) | L (mm) | B (mm) | D (mm) | S1 (mm) | S2 (mm) | PCS<br>packing: |     |
|---------|--------|--------|--------|--------|---------|---------|-----------------|-----|
| YT-0207 | 6x7    | 168    | 10.4   | 11.9   | 5.7     | 6.2     | 10              | 320 |
| YT-0209 | 8x9    | 183    | 13.3   | 14.8   | 6.7     | 7.2     | 10              | 160 |
| YT-0211 | 10x11  | 198    | 16.3   | 17.7   | 7.7     | 8.8     | 10              | 100 |
| YT-0213 | 12x13  | 217    | 19.2   | 20.6   | 8.7     | 9.2     | 10              | 100 |
| YT-0215 | 14x15  | 239    | 22.1   | 23.4   | 9.6     | 10.1    | 5               | 50  |
| YT-0217 | 16x17  | 260    | 25.0   | 26.4   | 10.6    | 10.9    | 5               | 60  |

| YATO    | Ø (mm) | L (mm) | B (mm) | D (mm) | S1 (mm) | S2 (mm) | PCS<br>packing: |    |
|---------|--------|--------|--------|--------|---------|---------|-----------------|----|
| YT-0219 | 18x19  | 292    | 27.9   | 29.4   | 11.2    | 11.5    | 5               | 60 |
| YT-0222 | 20x22  | 318    | 30.8   | 33.7   | 11.8    | 12.5    | 5               | 30 |
| YT-0223 | 21x23  | 326    | 32.3   | 35.2   | 12.1    | 12.8    | 5               | 30 |
| YT-0227 | 24x27  | 329    | 36.6   | 40.7   | 13.1    | 14.0    | 5               | 30 |
| YT-0228 | 25x28  | 347    | 38.1   | 42.5   | 14.0    | 14.3    | 2               | 16 |
| YT-0232 | 30x32  | 362    | 45.2   | 49.2   | 15.0    | 15.7    | 2               | 16 |

1

GB Bi-hexagonal ring spanner set  
 D Doppelringschlüsselsatz  
 PL Komplet kluczy oczkowych odgiętych  
 RUS Набор ключей накидных изогнутых

CZ Klíče očkové vyhnuté sada  
 H Csillagkulcs készlet  
 RO Set chei inelare cu cot  
 F Set de clés contre-coudées

I Set chiavi poligonali doppie piegate  
 E Juego de llaves de estrella acodadas  
 CN 双头高颈梅花扳手组套

POUCH & COLOR BOX



DIN 838

CrV 6140

AS-DRIVE



**8** PCS 6x7, 8x9, 10x11, 12x13, 14x15, 16x17, 18x19, 20x22 mm

**10** PCS 6x7, 8x9, 10x11, 12x13, 14x15, 16x17, 18x19, 20x22, 21x23, 24x27 mm

**12** PCS 6x7, 8x9, 10x11, 12x13, 14x15, 16x17, 18x19, 20x22, 21x23, 24x27, 25x28, 30x32 mm

|             |   |
|-------------|---|
| <b>YATO</b> |   |
| YT-0248     | 6 |

|             |    |
|-------------|----|
| <b>YATO</b> |    |
| YT-0250     | 10 |

|             |   |
|-------------|---|
| <b>YATO</b> |   |
| YT-0252     | 4 |

GB Bi-hexagonal ring spanner  
 D Doppelringschlüssel  
 PL Klucz oczkowy odgięty  
 RUS Ключ накидной изогнутый  
 CZ Očkový klíč ohnutý  
 H Hajlítottszerű csillagkulcs  
 RO Cheie inelaro-curbată  
 F Clé contre-coudée  
 I Chiave poligonale doppio piegato  
 E Llave de estrella  
 CN 双头高颈梅花扳手

S.A.E.

DIN 838

CrV

AS-DRIVE

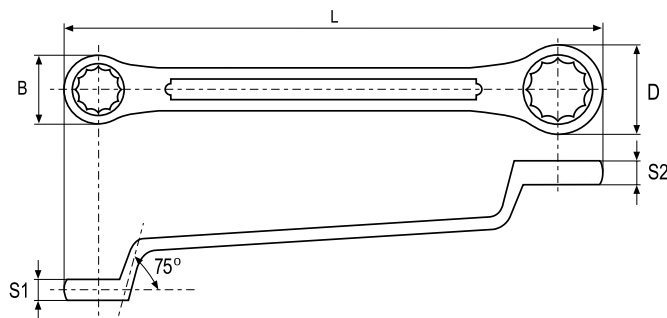

- application: industry
- surface finish: chromed, satin / mirror
- przeznaczenie: przemysł
- wykończenie powierzchni: chromowana, satynowa / polerowana

COLOR BOX



| YATO    |                                   | L (mm) | B (mm) | D (mm) | S1 (mm) | S2 (mm) | PCS packing |         |
|---------|-----------------------------------|--------|--------|--------|---------|---------|-------------|---------|
| YT-4860 | 3/8" (9.5 mm) x 7/16" (11.1 mm)   | 200    | 16.2   | 17.5   | 6.8     | 6.4     | 10          | 150/300 |
| YT-4861 | 1/2" (12.7 mm) x 9/16" (14.3 mm)  | 235    | 21.8   | 23.3   | 8.4     | 8.3     | 10          | 80/160  |
| YT-4862 | 11/16" (17.5 mm) x 3/4" (19.0 mm) | 265    | 27.0   | 28.3   | 10.1    | 10.0    | 10          | 50/100  |

| YATO    |                                   | L (mm) | B (mm) | D (mm) | S1 (mm) | S2 (mm) | PCS packing |       |
|---------|-----------------------------------|--------|--------|--------|---------|---------|-------------|-------|
| YT-4863 | 13/16" (20.6 mm) x 7/8" (22.2 mm) | 280    | 30.5   | 33.3   | 11.1    | 11.9    | 10          | 20/40 |
| YT-4864 | 7/8" (22.2 mm) x 15/16" (23.8 mm) | 305    | 33.2   | 35.9   | 11.8    | 13.3    | 5           | 10    |
| YT-4865 | 15/16" (23.8 mm) x 1" (25.4 mm)   | 325    | 35.8   | 40.0   | 13.6    | 13.7    | 5           | 10    |



- GB Ring impact wrench  
D Schlagringschlüssel  
PL Klucz do pobijania ocockowy  
RUS Ключ закрытый для растряски  
CZ Klíč maticový očkový rázový  
H Űtőcsillagkulcs  
RO Cheie inelară cu bătător  
F Clé à frapper à œil  
I Chiave poligonale semplice a percussione  
E Llave de muletilla para usarse dando golpes  
CN 敲击梅花扳手

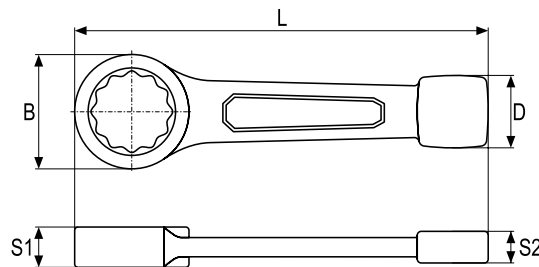

- application: industry
- 12 point profile
- AS-Drive system
- drop forged
- surface finish: black oxidised
- przeznaczenie: przemysł
- profil 12-kątny
- system AS-Drive
- kute
- wykończenie powierzchni: czarna, oksydowana

| YATO    | Ø (mm) | L (mm) | B (mm) | D (mm) | S1 (mm) | S2 (mm) |      |
|---------|--------|--------|--------|--------|---------|---------|------|
| YT-1601 | 24     | 160    | 41     | 31     | 15.0    | 10      | 5/25 |
| YT-1602 | 27     | 185    | 47     | 33     | 15.0    | 12      | 5/25 |
| YT-1603 | 30     | 190    | 51     | 35     | 16.5    | 14      | 5/25 |
| YT-1604 | 32     | 195    | 54     | 37     | 16.5    | 15      | 5/25 |
| YT-1605 | 36     | 210    | 60     | 39     | 20.0    | 17      | 5/10 |
| YT-1606 | 38     | 210    | 60     | 39     | 20.0    | 17      | 5/10 |
| YT-1607 | 41     | 225    | 66     | 42     | 20.0    | 18      | 5/10 |

| YATO    | Ø (mm) | L (mm) | B (mm) | D (mm) | S1 (mm) | S2 (mm) |      |
|---------|--------|--------|--------|--------|---------|---------|------|
| YT-1608 | 46     | 240    | 74     | 44     | 22.0    | 19      | 5/10 |
| YT-1609 | 50     | 250    | 80     | 45     | 23.0    | 20      | 5/10 |
| YT-1610 | 55     | 270    | 86     | 55     | 25.0    | 22      | 5/10 |
| YT-1611 | 58     | 270    | 86     | 55     | 25.0    | 22      | 5    |
| YT-1612 | 60     | 270    | 92     | 60     | 25.0    | 23      | 5    |
| YT-1613 | 65     | 290    | 100    | 65     | 30.0    | 24      | 5    |
| YT-1614 | 70     | 310    | 108    | 70     | 32.0    | 25      | 5    |

- GB Open end impact wrench  
D Schlagschraubenschlüssel  
PL Klucz do pobijania płaski  
RUS Ключ плоский для растряски  
CZ Klíč maticový plochý rázový  
H Űtőlaposkulcs  
RO Cheie fixă cu bătător  
F Clé à frapper plate  
I Chiave a forchetta semplice a percussione  
E Llave de boca abierta para usarse dando golpes  
CN 敲击开口扳手

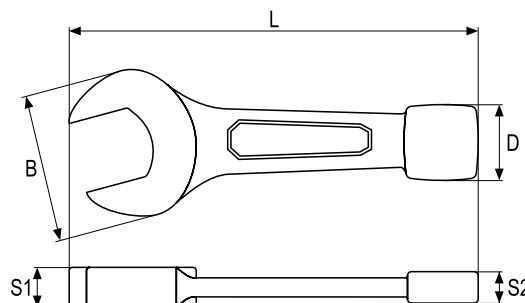

- application: industry
- head offset: 15°
- drop forged
- surface finish: black oxidised
- przeznaczenie: przemysł
- kąt odchylenia główki: 15°
- kute
- wykończenie powierzchni: czarna, oksydowana

| YATO    | Ø (mm) | L (mm) | B (mm) | D (mm) | S1 (mm) | S2 (mm) |      |
|---------|--------|--------|--------|--------|---------|---------|------|
| YT-1615 | 27     | 180    | 55     | 33     | 15      | 12      | 5/25 |
| YT-1616 | 30     | 187    | 63     | 35     | 17      | 14      | 5/25 |
| YT-1617 | 32     | 195    | 67     | 37     | 18      | 15      | 5/25 |
| YT-1618 | 36     | 210    | 77     | 39     | 18      | 17      | 5/10 |

| YATO    | Ø (mm) | L (mm) | B (mm) | D (mm) | S1 (mm) | S2 (mm) |      |
|---------|--------|--------|--------|--------|---------|---------|------|
| YT-1619 | 41     | 225    | 89     | 42     | 20      | 18      | 5/10 |
| YT-1620 | 46     | 255    | 98     | 44     | 20      | 19      | 5/10 |
| YT-1621 | 50     | 280    | 107    | 45     | 22      | 20      | 5    |
| YT-1622 | 55     | 310    | 118    | 55     | 25      | 22      | 5    |

1

GB Half-moon spanner  
D Starter- und Blockschlüssel  
PL Klucz oczkowy typu „C”  
RUS Ключ накладной изогнутый „C”  
CZ Klíč očkoploché typ „C”  
H Félhold alakú csillagkulcs  
RO Cheie inelara semi-luna  
F Clé à ceill „C”

I Chiave poligonale doppio speciale tipo „C”  
E Llave de estrella tipo „C”  
CN C型梅花扳手

CrV 6140 AS-DRIVE

- application: industry
- excellent for work in tight spaces
- used for dismantling of collector tubes, alternators and starters
- surface finish: chromed, satin
- przeznaczenie: przemysł
- do pracy w miejscach szczególnie trudnodostępnych
- ułatwia odkręcanie kolektorów, alternatorów i rozruszników samochodowych
- wykończenie powierzchni: chromowana, satynowa

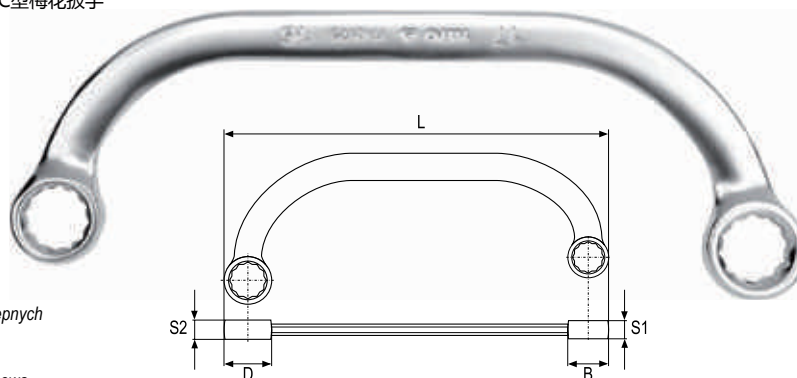

| YATO    | Ø (mm) | L (mm) | B (mm) | D (mm) | S1 (mm) | S2 (mm) | Box   |
|---------|--------|--------|--------|--------|---------|---------|-------|
| YT-0170 | 10x12  | 145    | 16.8   | 19.2   | 6.8     | 6.8     | 10/60 |
| YT-0171 | 11x13  | 170    | 18.5   | 21.2   | 8.4     | 8.6     | 10/60 |
| YT-0172 | 14x15  | 195    | 22.8   | 25.8   | 9.2     | 9.9     | 10/60 |

| YATO    | Ø (mm) | L (mm) | B (mm) | D (mm) | S1 (mm) | S2 (mm) | Box   |
|---------|--------|--------|--------|--------|---------|---------|-------|
| YT-0173 | 16x17  | 220    | 26.2   | 28.6   | 9.9     | 10.5    | 10/60 |
| YT-0175 | 19x22  | 260    | 28.7   | 32.9   | 10.4    | 10.9    | 6/60  |

GB Reversible half-moon spanner  
D Doppelingratschenschlüssel  
PL Klucz typu „C” z grzechotką  
RUS Ключ накладной изогнутый с трехоткой  
CZ Klíč očkový ráčnový typu „C”  
H Csillagkulcs racsnis hajlított  
RO Cheie reversibila semi-luna

F Clé mixte à cliquet  
I Chiave tipo „C” con cricchetto  
E Llave de carraca de dos bocas con angulo  
CN C型双向棘轮梅花扳手

72T CrV 6140 AS-DRIVE

- application: industry
- minimum operation angle: 5°
- direction switch
- excellent for work in tight spaces
- used for dismantling of collector tubes, alternators and starters
- surface finish: chromed, mirror
- przeznaczenie: przemysł
- minimalny kąt pracy: 5°
- zmiana kierunku obrotu
- do pracy w miejscach szczególnie trudnodostępnych
- ułatwia odkręcanie kolektorów, alternatorów i rozruszników samochodowych
- wykończenie powierzchni: chromowana, polerowana

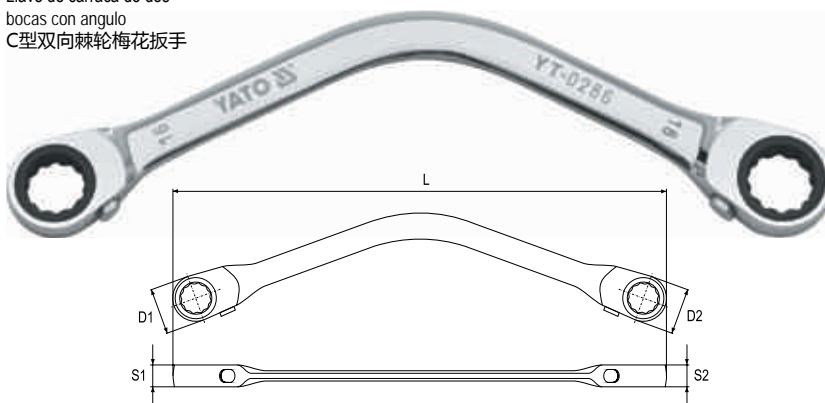

| YATO    | Ø (mm) | L (mm) | D1 (mm) | D2 (mm) | S1 (mm) | S2 (mm) | Box    |
|---------|--------|--------|---------|---------|---------|---------|--------|
| YT-0284 | 12x15  | 206    | 23.6    | 28.2    | 8.4     | 8.4     | 10/100 |
| YT-0286 | 16x18  | 247    | 28.6    | 31.7    | 10.0    | 11.5    | 10/100 |
| YT-0287 | 17x19  | 260    | 29.7    | 33.8    | 10.0    | 11.5    | 10/100 |

GB Flare nut wrench  
D Schraubenschlüssel, halboffen  
PL Klucz oczkowy półotwarty  
RUS Ключ накладной полуоткрытый  
CZ Klíč prstencový polootevřený  
H Csuklós, nyitott

RO Cheie inelară semideschisă  
F Clé mixte à cliquet  
I Chiave poligonale semiaperto  
E Llave semiabierta  
CN 油管扳手

CrV 6140

GB Flare nut wrench set  
D Schraubenschlüssel, halboffen  
PL Zestaw kluczy oczkowych półotwartych  
RUS Ключ накладной полуоткрытый  
CZ Klíč prstencový polootevřený  
H Csuklós, nyitott

RO Cheie inelară semideschisă  
F Set de clés à tête fendue  
I Set chiavi poligonali semiaperte  
E Llave semiabierta  
CN 油管扳手组套

4 PCS

CrV 6140

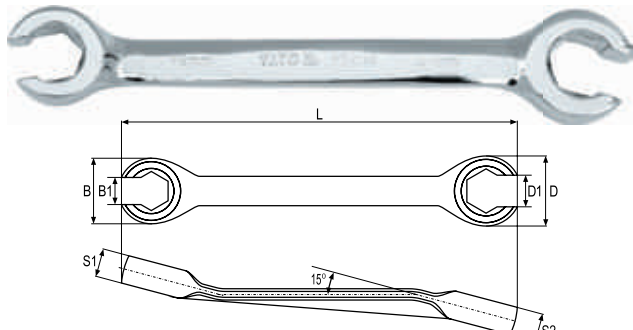

COLOR BOX

| YATO     | Ø (mm) | L (mm) | B (mm) | D (mm) | B1 (mm) | D1 (mm) | S1 (mm) | S2 (mm) | PCS packing | Box     |
|----------|--------|--------|--------|--------|---------|---------|---------|---------|-------------|---------|
| YT-0135  | 8x10   | 140    | 18.7   | 21.8   | 6.2     | 7.2     | 7.7     | 8.4     | 10          | 200/400 |
| YT-0136  | 11x12  | 160    | 21.2   | 24.0   | 8.1     | 9.2     | 8.5     | 9.5     | 10          | 100/200 |
| YT-0137  | 13x14  | 175    | 26.3   | 27.3   | 9.6     | 10.7    | 9.6     | 10.5    | 10          | 100/200 |
| YT-0138  | 15x17  | 190    | 31.2   | 31.2   | 11.8    | 13.0    | 11.5    | 10.9    | 10          | 50/100  |
| YT-01385 | 17x19  | 195    | 29.0   | 31.2   | 14.5    | 15.0    | 12.4    | 12.8    | 10          | 50/100  |
| YT-0139  | 19x21  | 230    | 36.3   | 42.1   | 14.7    | 16.7    | 12.4    | 12.8    | 10          | 50/100  |
| YT-0140  | 22x24  | 250    | 42.7   | 44.2   | 17.1    | 18.6    | 13.2    | 13.9    | 10          | 50/100  |



POUCH & COLOR BOX

8x10, 11x12, 13x14, 15x17 mm

| YATO    | Box   |
|---------|-------|
| YT-0143 | 25/50 |



GB Flexible flare nut wrench  
D Schraubenschlüssel, halboffen mit Gelenk  
PL Klucz oczkowy półotwarty z przegubem  
RUS Ключ накладной полуоткрытый с шарниром  
CZ Klíč prstencový polootevřený s kloubem  
H Csuklós, nyitott csillagkulcs  
RO Cheie inelară semideschisă, cu articulație  
F Clé à tête fendue articulée  
I Chiave poligonale a due bocche aperte con testa snodata  
E Llave semiabierta con una junta  
CN 活头油管扳手

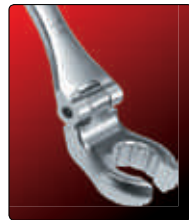

GB Flexible flare nut wrench set  
D Schraubenschlüssel, halboffen mit Gelenk  
PL Komplet kluczy oczkowych półotwartych z przegubem  
RUS Ключ накладной полуоткрытый с шарниром  
CZ Klíč prstencový polootevřený s kloubem  
H Csuklós, nyitott csillagkulcs  
RO Cheie inelară semideschisă, cu articulație  
F Set de clés à tête fendue articulée  
I Set chiavi poligonali a due bocche aperte con testa snodata  
E Llave semiabierta con una junta  
CN 活头油管扳手套组

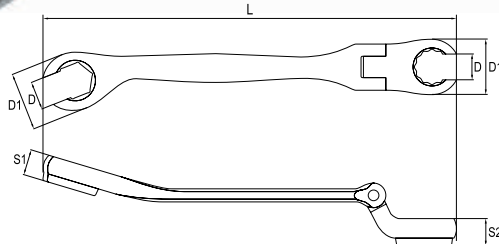
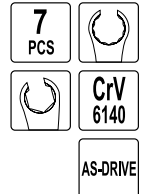

- application: industry
- articulated joint at 12 point head
- ring for nuts in sockets
- for use on hydraulic lines
- for use on fuel lines
- for use on brake system lines
- ergonomic handle
- surface finish: chromed, satin
- przeznaczenie: przemysł
- przegub przy profilu 12-kątnym
- pierścień do gniazd nakrętek
- do przewodów hydraulicznych
- do przewodów paliwowych
- do przewodów hamulcowych
- ergonomiczna rączka
- wykończenie powierzchni: chromowana, satynowa

PLASTIC HANGER

| YATO    | Ø (mm) | L (mm) | D (mm) | D1 (mm) | S1 (mm) | S2 (mm) |        |
|---------|--------|--------|--------|---------|---------|---------|--------|
| YT-0180 | 8      | 128    | 6.0    | 18.0    | 7.0     | 7.0     | 24/288 |
| YT-0181 | 9      | 128    | 6.5    | 18.0    | 7.0     | 7.0     | 24/288 |
| YT-0184 | 12     | 148    | 9.0    | 22.0    | 9.0     | 9.0     | 24/216 |
| YT-0185 | 13     | 175    | 10.0   | 26.0    | 11.0    | 11.0    | 12/120 |
| YT-0186 | 14     | 175    | 11.0   | 26.0    | 11.0    | 11.0    | 12/120 |
| YT-0187 | 15     | 175    | 12.0   | 26.0    | 11.0    | 11.0    | 12/120 |

GB Torx ring spanner set  
D Torx-Ringschlüsselsatz  
PL Komplet kluczy oczkowych Torx  
RUS Набор накидных ключей  
CZ Očkové klíče  
H Csillagkulcs készlet  
RO Chei inelare  
F Set de clés à œil  
I Set chiavi doppie Torx  
E Llaves de anillo Torx  
CN 星型扳手套组



E6xE8, E10xE12, E14xE18, E20xE24

SLIDING CARD

| YATO    |       |
|---------|-------|
| YT-0530 | 10/60 |

GB L-type socket wrench  
D Steckschlüssel gebogen  
PL Klucz nasadowy typu „L”  
RUS Ключ торцевой „L” типа  
CZ Nástrčný klíč fajfkový  
H Kulcs, dugó-pipa  
RO Cheie tubulara cu cot tip „L”  
F Clé à pipe en L  
I Chiave a tubo doppio tipo „L”  
E Llave de vaso „L”  
CN L 型套筒扳手

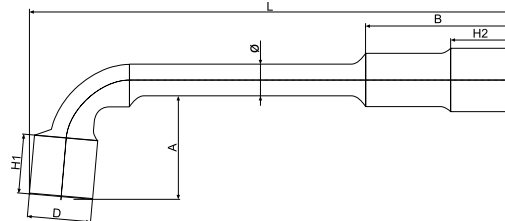

CrV  
6140

| YATO    | Ø (mm) | L (mm) | B (mm) | H1 (mm) | H2 (mm) | A (mm) | D (mm) | Ø (mm) |       |
|---------|--------|--------|--------|---------|---------|--------|--------|--------|-------|
| YT-1627 | 7      | 106    | 27.0   | 10.2    | 10.1    | 21.0   | 10.7   | 7      | 12/60 |
| YT-1628 | 8      | 117    | 29.5   | 12.3    | 11.9    | 18.5   | 12.2   | 9      | 12/60 |
| YT-1629 | 9      | 121    | 31.7   | 13.4    | 12.8    | 19.1   | 13.2   | 10     | 12/60 |
| YT-1630 | 10     | 131    | 35.1   | 16.4    | 16.9    | 23.3   | 15.0   | 10     | 12/60 |
| YT-1631 | 11     | 138    | 36.0   | 16.5    | 16.8    | 24.7   | 16.3   | 11     | 12/60 |
| YT-1632 | 12     | 147    | 42.5   | 17.9    | 18.2    | 17.9   | 18.0   | 12     | 12/60 |
| YT-1633 | 13     | 154    | 44.2   | 18.5    | 19.1    | 30.1   | 19.3   | 12     | 12/60 |
| YT-1634 | 14     | 162    | 47.0   | 19.3    | 20.3    | 30.2   | 20.8   | 13     | 12/60 |
| YT-1635 | 15     | 173    | 48.9   | 20.6    | 21.6    | 31.6   | 22.3   | 13     | 12/60 |
| YT-1636 | 16     | 182    | 55.0   | 23.2    | 23.1    | 37.3   | 23.6   | 14     | 12/60 |
| YT-1637 | 17     | 188    | 57.0   | 25.1    | 25.5    | 37.9   | 25.1   | 14     | 12/36 |

| YATO    | Ø (mm) | L (mm) | B (mm) | H1 (mm) | H2 (mm) | A (mm) | D (mm) | Ø (mm) |       |
|---------|--------|--------|--------|---------|---------|--------|--------|--------|-------|
| YT-1638 | 18     | 192    | 57.1   | 25.1    | 24.6    | 40.1   | 26.0   | 14     | 12/36 |
| YT-1639 | 19     | 207    | 62.3   | 26.9    | 27.4    | 41.6   | 28.2   | 16     | 12/36 |
| YT-1640 | 20     | 215    | 62.4   | 27.0    | 28.3    | 42.4   | 29.2   | 16     | 6/24  |
| YT-1641 | 21     | 221    | 65.0   | 30.5    | 30.6    | 54.0   | 30.2   | 16     | 6/24  |
| YT-1642 | 22     | 232    | 67.5   | 30.8    | 30.6    | 49.1   | 31.7   | 16     | 6/24  |
| YT-1643 | 23     | 242    | 77.1   | 31.4    | 31.2    | 51.6   | 33.0   | 17     | 6/18  |
| YT-1644 | 24     | 253    | 78.2   | 32.3    | 31.7    | 53.5   | 33.6   | 17     | 6/18  |
| YT-1647 | 27     | 288    | 85.3   | 36.9    | 36.4    | 54.7   | 37.6   | 20     | 6/12  |
| YT-1649 | 30     | 310    | 95.0   | 38.4    | 38.6    | 65.3   | 42.0   | 22     | 6/12  |
| YT-1650 | 32     | 339    | 99.2   | 40.4    | 40.5    | 66.8   | 43.8   | 22     | 6     |

1

- GB Open end swivel head socket wrench
- D Maul-Steckschlüssel
- PL Klucz płasko-nasadowy przegubowy
- RUS Ключ рожково-торцевой
- CZ Klic nasad. ploch.
- H Kulcs villás-dugó
- RO Cheie fixe-tubulare
- F Clé mixte tête articulée (plat/à tube)
- I Chiave combinata a bussola con snodo
- E Combinada con vaso
- CN 套筒开口扳手

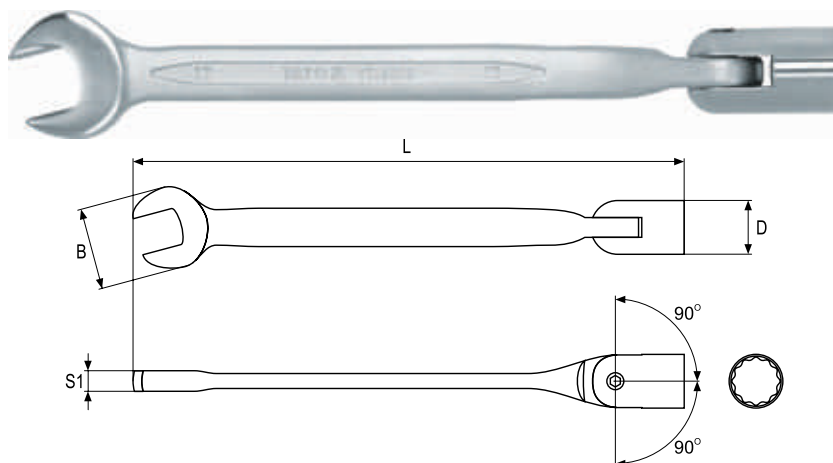

CrV  
6140

COLOR BOX



| YATO    | Ø (mm) | L (mm) | B (mm) | D (mm) | S1 (mm) | PCS packing |     |
|---------|--------|--------|--------|--------|---------|-------------|-----|
| YT-4950 | 8      | 168    | 19.5   | 12.9   | 6.0     | 10          | 240 |
| YT-4951 | 10     | 178    | 20.7   | 14.6   | 6.4     | 10          | 240 |
| YT-4952 | 11     | 188    | 25.4   | 15.9   | 6.9     | 10          | 200 |
| YT-4953 | 12     | 191    | 25.3   | 17.9   | 6.7     | 10          | 160 |

| YATO    | Ø (mm) | L (mm) | B (mm) | D (mm) | S1 (mm) | PCS packing |     |
|---------|--------|--------|--------|--------|---------|-------------|-----|
| YT-4954 | 13     | 205    | 28.8   | 18.8   | 6.8     | 10          | 120 |
| YT-4955 | 14     | 222    | 31.8   | 19.8   | 6.8     | 10          | 80  |
| YT-4956 | 17     | 232    | 37.0   | 23.9   | 7.8     | 10          | 80  |
| YT-4957 | 19     | 248    | 42.1   | 25.8   | 7.5     | 10          | 60  |

- GB Open end swivel head socket wrench set
- D Maul-Steckschlüsselsatz
- PL Klucze płasko-nasadowe przegubowe
- RUS Ключи рожк.-торц.-назор
- CZ Ploché nýstrčné klíče kloubové
- H Kulcs villás-csuklós dugó
- RO Set chei fixe + tubulare
- F Set de clés mixtes tête articulée (plat/à tube)

- I Set chiavi a tubo
- E Combinadas con vaso articulado
- CN 套筒开口扳手组套

6  
PCS

CrV  
6140



POUCH & COLOR BOX



8, 10, 12, 13, 17, 19 mm

| YATO    |  |    |
|---------|--|----|
| YT-4960 |  | 20 |

- GB Double flexible socket wrench
- D Steckschlüssel
- PL Klucz nasadowy przegubowy
- RUS Ключ торцевой
- CZ Nástrčné klíče kloubové
- H Csuclós dugókulcs
- RO Set chei tubulare cu articulație
- F Clé à tube tête articulée
- I Chiave a doppia bussola snodata
- E Llave de vaso articulado
- CN 活头双头套筒扳手

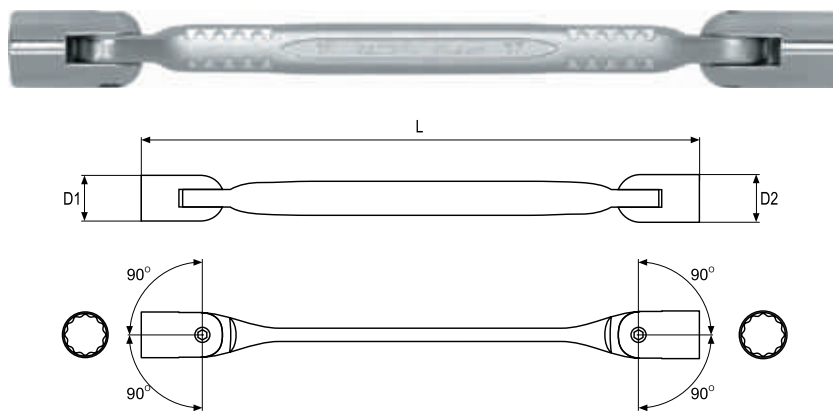

CrV  
6140

COLOR BOX



| YATO    | Ø (mm) | L (mm) | D1 (mm) | D2 (mm) | PCS packing |     |
|---------|--------|--------|---------|---------|-------------|-----|
| YT-4961 | 8x9    | 183    | 12.9    | 13.7    | 10          | 200 |
| YT-4962 | 10x11  | 202    | 14.6    | 15.8    | 10          | 160 |
| YT-4963 | 12x13  | 218    | 17.6    | 18.8    | 10          | 120 |

| YATO    | Ø (mm) | L (mm) | D1 (mm) | D2 (mm) | PCS packing |    |
|---------|--------|--------|---------|---------|-------------|----|
| YT-4964 | 14x15  | 239    | 19.8    | 21.7    | 10          | 80 |
| YT-4965 | 16x17  | 257    | 23.8    | 23.9    | 10          | 40 |
| YT-4966 | 18x19  | 274    | 25.8    | 25.8    | 10          | 40 |



- GB Heavy duty tubular socket wrench
- D Rohrsteckschlüsselsatz
- PL Klucz rurowy kuty
- RUS Ключ двухлучевой с головками
- CZ Klíče trubkové
- H Csőkulcs
- RO Cheie pt. țevi
- F Clé à tube double droite
- I Chiave a tubo
- E Llave de tubería
- CN 小轮胎扳手

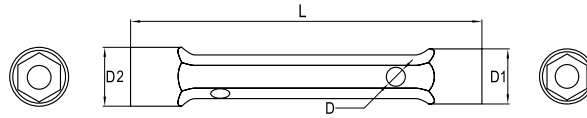

CrV  
40 AS-DRIVE



| YATO    | Ø (mm) | D1 (mm) | D2 (mm) | D (mm) | L (mm) | PCS packing: |        |
|---------|--------|---------|---------|--------|--------|--------------|--------|
| YT-4915 | 8x9    | 13      | 14      | 3      | 110    | 10           | 60/240 |
| YT-4916 | 10x11  | 15      | 16      | 5      | 120    | 10           | 60/240 |
| YT-4917 | 12x13  | 18      | 19      | 6      | 140    | 10           | 60/120 |
| YT-4918 | 14x15  | 20      | 22      | 6      | 145    | 10           | 60/120 |
| YT-4919 | 16x17  | 23      | 24      | 7      | 155    | 10           | 60/120 |
| YT-4920 | 18x19  | 25      | 26      | 8      | 165    | 5            | 40/80  |

| YATO    | Ø (mm) | D1 (mm) | D2 (mm) | D (mm) | L (mm) | PCS packing: |       |
|---------|--------|---------|---------|--------|--------|--------------|-------|
| YT-4921 | 20x22  | 28      | 30      | 8      | 170    | 5            | 30/60 |
| YT-4922 | 21x23  | 29      | 31      | 10     | 185    | 5            | 30/60 |
| YT-4923 | 24x26  | 33      | 35      | 12     | 190    | 5            | 40    |
| YT-4924 | 25x28  | 34      | 37      | 12     | 205    | 5            | 40    |
| YT-4925 | 27x29  | 37      | 39      | 12     | 210    | 5            | 40    |
| YT-4926 | 30x32  | 40      | 42      | 13     | 210    | 5            | 20    |

- GB Tubular socket wrench handle
- D Stellstab für Rohrschlüssel
- PL Pokręto do kluczy rurowych
- RUS Вороток к трубчатым ключам
- CZ Tyčka k trubkovým klíčům
- H Forgatókar dugókulcshoz
- RO Clupă pt. chei tubulare
- F Support de clés à tube
- I Spina di manovra per chiave a tubo doppia
- E Mango para las llaves de tubo
- CN 旋棒



| YATO    | L (mm) | mm                        | PCS packing: |     |
|---------|--------|---------------------------|--------------|-----|
| YT-4927 | 190    | 2.5; 4.5; 5.5             | 50           | 150 |
| YT-4928 | 280    | 6.5; 7.5; 9.5; 11.5; 12.5 | 50           | 100 |

- GB Ratchet wrench
- D Gerüstratsche
- PL Klucz nasadkowy z grzechotką
- RUS Ключ торцовый с трещоткой
- CZ Ráčnový klíč průchozí
- H Kettős racsnis kulcs
- RO Cheie tubulara cu clichet
- F Clé à tube à cliquet
- I Chiavi a cricchetto per ponteggi
- E Llave de vaso con carraca
- CN 尖尾棘轮扳手

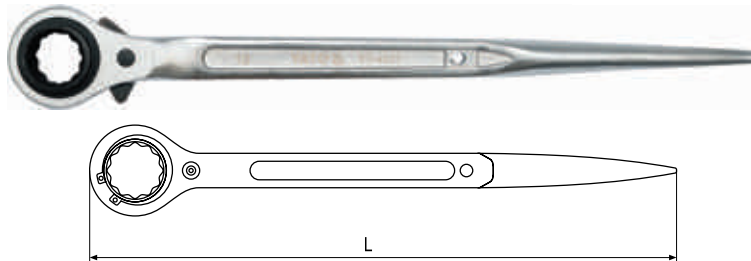

CrV 32T RATCHET WRENCH COLD FORGED KUTE NA ZMMO



PLASTIC HANGER

| YATO    | Ø (mm) | L (mm) |      |
|---------|--------|--------|------|
| YT-4937 | 19x22  | 315    | 2/40 |

- GB Double ratchet wrench
- D Gerüstratsche
- PL Dwustronny klucz nasadkowy z grzechotką
- RUS Ключ торцовый с трещоткой
- CZ Ráčnový klíč průchozí dvoustranný
- H Kettős racsnis kulcs
- RO Cheie tubulara dubla cu clichet
- F Clé à œil à cliquet
- I Chiave a cricco doppio
- E Llave de vaso con carraca
- CN 尖尾棘轮扳手

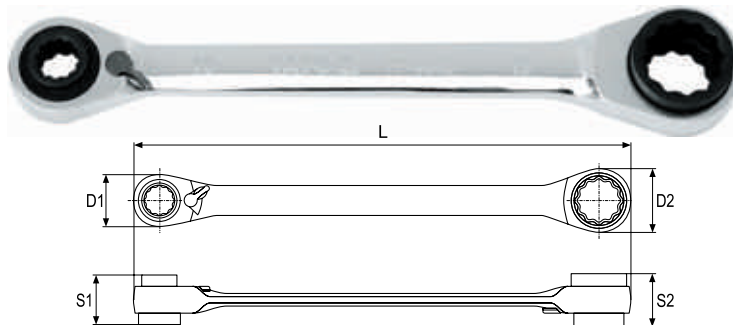

CrV 72T RATCHET WRENCH



DOUBLE BLISTER

| YATO    | Ø (mm)      | L (mm) | D1 (mm) | D2 (mm) | S1 (mm) | S2 (mm) |      |
|---------|-------------|--------|---------|---------|---------|---------|------|
| YT-4945 | 10x13x17x19 | 200    | 29      | 35      | 17      | 22      | 5/50 |

- GB Socket wrench with handle
- D Steckschlüssel
- PL Klucz nasadowy z rączką
- RUS Ключ торцевой
- CZ Nástrčný klíč
- H Kulcs
- RO Cheie tubulara
- F Clé à tube
- I Chiave a cricco doppio
- E Llave
- CN 六角套筒螺丝批

COLOR BOX



CrV HRC 44

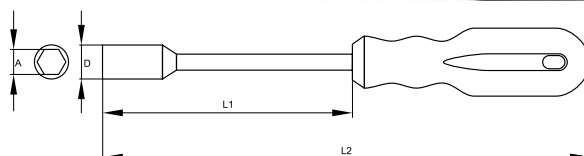

| YATO    | Ø (mm) | D (mm) | L1 (mm) | L2 (mm) | PCS packing: |     |
|---------|--------|--------|---------|---------|--------------|-----|
| YT-1541 | 5      | 8.0    | 125     | 242     | 6            | 120 |
| YT-1542 | 6      | 9.1    | 125     | 242     | 6            | 120 |
| YT-1543 | 7      | 10.9   | 125     | 242     | 6            | 120 |
| YT-1544 | 8      | 12.0   | 125     | 242     | 6            | 120 |
| YT-1545 | 9      | 13.0   | 125     | 242     | 6            | 120 |
| YT-1546 | 10     | 14.1   | 125     | 242     | 6            | 120 |
| YT-1547 | 11     | 15.9   | 125     | 242     | 6            | 120 |
| YT-1548 | 12     | 16.9   | 125     | 242     | 6            | 120 |
| YT-1549 | 13     | 18.0   | 125     | 242     | 6            | 120 |

1

**GB** T-type deep socket wrench with rotary handle  
**D** Steckschlüssel vom Typ „T“ mit drehbarem Handgriff  
**PL** Klucz nasadowy typu „T“ z obrotową rękojeścią  
**RUS** Торцовый ключ типа „T“ с вращательной ручкой  
**CZ** Klič nástrčný typ „T“ s otočnou rukojeťou

**H** „T“ típusú dugókulcs, forgatható karral  
**RO** Cheie tubulară de tip „T“ cu mâner rotativ  
**F** Clé à tube  
**I** Chiave tipo „T“ con manico scorrevole  
**E** Llave tubular „T“ con un mango giratorio  
**CN** T型套筒扳手

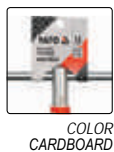

CrV 6140

AS-DRIVE

COLOR CARDBOARD

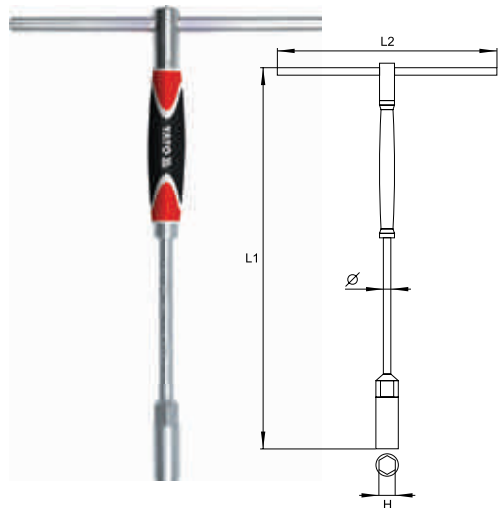

- ergonomic handle
- movable handle with position locking system
- long bar for work in deeply set, difficult to reach places

- ergonomiczna rękojeść
- przesuwane pokrętko z blokadą położenia
- długi trzpień umożliwiający pracę w głębokich wnękach

| YATO    | Ø H   | L1 (mm) | L2 (mm) | Ø (mm) |       |
|---------|-------|---------|---------|--------|-------|
| YT-1552 | 8 mm  | 310     | 200     | 10     | 10/40 |
| YT-1553 | 9 mm  | 310     | 200     | 10     | 10/40 |
| YT-1554 | 10 mm | 310     | 200     | 10     | 10/40 |
| YT-1555 | 11 mm | 310     | 200     | 10     | 10/40 |
| YT-1556 | 12 mm | 310     | 200     | 10     | 10/40 |
| YT-1557 | 13 mm | 310     | 200     | 10     | 10/40 |
| YT-1558 | 14 mm | 310     | 200     | 10     | 10/40 |
| YT-1559 | 15 mm | 310     | 200     | 10     | 10/40 |

**GB** T-type deep socket wrench  
**D** Steckschlüssel vom Typ „T“  
**PL** Klucz nasadowy typu „T“  
**RUS** Торцовый ключ типа „T“  
**CZ** Klič nástrčný typ „T“  
**H** „T“ típusú dugókulcs

**RO** Cheie tubulară de tip „T“  
**F** Clé à tube en „T“  
**I** Chiave a bussola tipo „T“  
**E** Llave tubular „T“  
**CN** T型套筒扳手

CrV 6140

AS-DRIVE

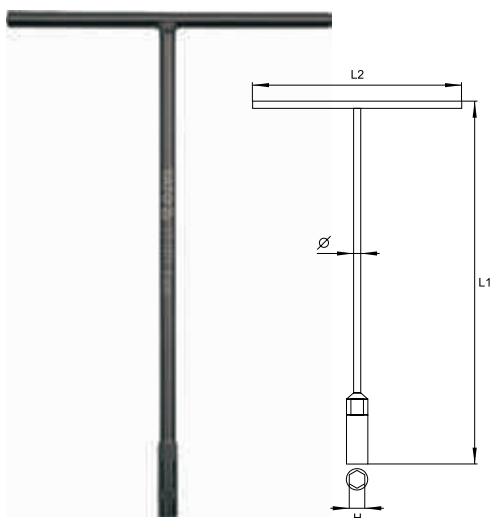

COLOR CARDBOARD



| YATO    | Ø H   | L1 (mm) | L2 (mm) | Ø (mm) |       |
|---------|-------|---------|---------|--------|-------|
| YT-1571 | 8 mm  | 310     | 200     | 10     | 10/40 |
| YT-1572 | 9 mm  | 310     | 200     | 10     | 10/40 |
| YT-1573 | 10 mm | 310     | 200     | 10     | 10/40 |
| YT-1574 | 11 mm | 310     | 200     | 10     | 10/40 |
| YT-1575 | 12 mm | 310     | 200     | 10     | 10/40 |
| YT-1576 | 13 mm | 310     | 200     | 10     | 10/40 |
| YT-1577 | 14 mm | 310     | 200     | 10     | 10/40 |
| YT-1578 | 15 mm | 310     | 200     | 10     | 10/40 |

**GB** T-type adapter with rotary handle  
**D** Adapter vom Typ „T“ mit drehbarem Handgriff  
**PL** Adapter typu „T“ z obrotową rękojeścią  
**RUS** Адаптер типа „Т“ с вращательной ручкой  
**CZ** Adaptér typ „T“ s otočnou rukojeťou  
**H** „T“ típusú adapter, forgatható karral  
**RO** Adaptor tip „T“ cu mâner rotativ  
**F** Adapteur  
**I** Adattatore tipo „T“ con manico scorrevole  
**E** Adaptador „T“ con un mango giratorio  
**CN** T型套筒扳手



1/4"

6.3mm

3/8"

10mm

1/2"

12.5mm

CrV 6140

COLOR CARDBOARD

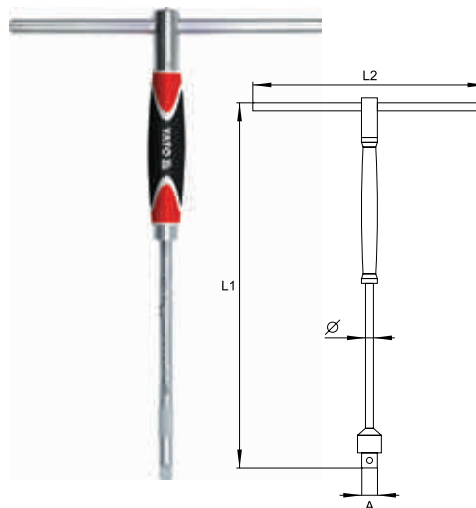

- ergonomic handle
- movable handle with position locking system
- long bar for work in deeply set, difficult to reach places

- ergonomiczna rękojeść
- przesuwane pokrętko z blokadą położenia
- długi trzpień umożliwiający pracę w głębokich wnękach

| YATO    | Ø H            | L1 (mm) | L2 (mm) | Ø (mm) |       |
|---------|----------------|---------|---------|--------|-------|
| YT-1565 | 1/4" (6.3 mm)  | 310     | 200     | 8      | 10/40 |
| YT-1566 | 3/8" (9.5 mm)  | 310     | 200     | 10     | 10/40 |
| YT-1567 | 1/2" (12.7 mm) | 310     | 200     | 10     | 10/40 |

**GB** Y-type socket wrench  
**D** Steckschlüssel vom Typ „Y“  
**PL** Klucz nasadowy typu „Y“  
**RUS** Торцовый ключ типа „Y“  
**CZ** Klič nástrčný typ „Y“  
**H** „Y“ típusú dugókulcs

**RO** Cheie tubulară de tip „Y“  
**F** Clé à tube en „Y“  
**I** Chiave a bussola tipo „Y“  
**E** Llave tubular „Y“  
**CN** Y型套筒扳手

CrV 6140

AS-DRIVE



COLOR CARDBOARD



| YATO    | Ø H         | L (mm) | Ø (mm) |       |
|---------|-------------|--------|--------|-------|
| YT-1586 | 12-14-17 mm | 140    | 10     | 10/40 |



GB Adjustable wrench  
D Rollgabelschlüssel  
PL Klucz nastawny  
RUS Ключ разводной



CZ Nastavitelný klíč  
H Állítható svédkulcs  
RO Cheie reglabilă  
F Clé à molette

I Chiave a rullino graduata  
E Llave ajustable  
tipo inglesa  
CN 活络扳手

150 mm 200 mm 250 mm 300 mm 375 mm



HALF  
DOUBLE  
BLISTER

| YATO  | L (mm) |  |
|--|--------|---|
| YT-2071  | 150    | 6/60  |
| YT-2072  | 200    | 6/60  |
| YT-2073  | 250    | 6/36  |
| YT-2074  | 300    | 6/24  |
| YT-2075  | 375    | 6/12  |

GB Adjustable wrench  
D Rollgabelschlüssel  
PL Klucz nastawny  
RUS Ключ разводной



CZ Nastavitelný klíč  
H Állítható svédkulcs  
RO Cheie reglabilă  
F Clé à molette

I Chiave a rullino graduata  
E Llave ajustable  
tipo inglesa  
CN 活络扳手

150 mm 200 mm 250 mm 300 mm DIN 3117 CrV



HALF  
DOUBLE  
BLISTER

| YATO  | L (mm) |  |
|---|--------|--|
| YT-2165   | 150    | 6/120  |
| YT-2166   | 200    | 6/60   |
| YT-2167   | 250    | 6/36   |
| YT-2168   | 300    | 6/24   |

GB Adjustable wrench  
D Rollgabelschlüssel  
PL Klucz nastawny  
RUS Ключ разводной



CZ Nastavitelný klíč  
H Állítható svédkulcs  
RO Cheie reglabilă  
F Clé à molette

I Chiave a rullino graduata  
E Llave ajustable  
tipo inglesa  
CN 活络扳手

150 mm 200 mm 250 mm 300 mm DIN 3117 CrV



HALF  
DOUBLE  
BLISTER

| YATO  | L (mm) |  |
|--|--------|---|
| YT-2170  | 150    | 6/72  |
| YT-2171  | 200    | 6/60  |
| YT-2172  | 250    | 6/48  |
| YT-2173  | 300    | 6/36  |

GB Adjustable wrench  
D Rollgabelschlüssel  
PL Klucz nastawny  
RUS Ключ разводной

CZ Nastavitelný klíč  
H Állítható svédkulcs  
RO Cheie reglabilă  
F Clé à molette

I Chiave a rullino graduata  
E Llave ajustable  
tipo inglesa  
CN 活络扳手

150 mm 200 mm 250 mm 300 mm 375 mm DIN 3117 DROP FORGED KUTE



HALF  
DOUBLE  
BLISTER

| YATO  | L (mm) | opening capacity (mm)<br>zakres rozwarcia szczęk (mm) |  |
|--|--------|---|---|
| YT-21650   | 150    | 19.3  | 6/36  |
| YT-21651   | 200    | 24.0  | 6/36  |
| YT-21652   | 250    | 30.0  | 6/36  |
| YT-21653   | 300    | 36.0  | 6/24  |
| YT-21654   | 375    | 45.0  | 2/16  |

# 2

**Sockets, accessories & sets**  
**Klucze nasadowe,**  
**akcesoria i zestawy**







|   |   |    |
|---|---|----|
| <b>Sockets 1/4"</b><br>Klucze nasadowe 1/4" |  | 27 |
|---|---|----|

|  |    |
|--|----|
| Hexagonal sockets<br>Klucze nasadowe sześciokątne, krótkie     | 27 |
| Hexagonal deep sockets<br>Klucze nasadowe sześciokątne, długie | 27 |

|  |    |
|--|----|
| Bit adapters<br>Adaptery do bitów              | 32 |
| Universal joints<br>Przeguby Cardana           | 32 |
| Sliding T-bars<br>Pokręta typu „T”             | 32 |
| Flexible handles<br>Pokręta łamane             | 32 |
| Spark plug sockets<br>Klucze nasadowe do świec | 32 |

|   |   |       |
|---|---|-------|
| <b>Accessories 1/4"</b><br>Akcesoria 1/4" |  | 27-28 |
|---|---|-------|

|   |    |
|---|----|
| Extension bars<br>Przedłużki                      | 27 |
| Extension bars with wobble<br>Przedłużki uchylnie | 27 |
| Flexible extension cords<br>Przedłużki elastyczne | 28 |
| Adapters<br>Redukcje                              | 28 |
| Bit adapters<br>Adaptery do bitów                 | 28 |
| Universal joints<br>Przeguby Cardana              | 28 |
| Spinner handles<br>Pokręta do nasadek             | 28 |
| Sliding T-bars<br>Pokręta typu „T”                | 28 |
| Flexible handles<br>Pokręta łamane                | 28 |

|  |   |       |
|--|---|-------|
| <b>Ratchet handles 3/8"</b><br>Grzechotki 3/8" |  | 33-34 |
|--|---|-------|

|  |    |
|--|----|
| Ratchet handles<br>Grzechotki                                    | 33 |
| Flexible ratchet handles<br>Grzechotki z przegubem               | 33 |
| Composite ratchet handles<br>Grzechotki powlekane                | 33 |
| Curved ratchet handles<br>Grzechotki wygięte                     | 34 |
| Telescopic ratchet handles<br>Grzechotki z przedłużonym uchwytem | 34 |

|  |   |       |
|--|---|-------|
| <b>Ratchet handles 1/4"</b><br>Grzechotki 1/4" |  | 29-30 |
|--|---|-------|

|   |    |
|---|----|
| Ratchet handles<br>Grzechotki   | 29 |
| Flexible ratchet handles<br>Grzechotki z przegubem                    | 29 |
| Composite ratchet handles<br>Grzechotki powlekane                     | 29 |
| Curved ratchet handles<br>Grzechotki wygięte                          | 30 |
| Telescopic ratchet handles<br>Grzechotki z przedłużonym uchwytem      | 30 |
| Bit and socket drive ratchet handles<br>Grzechotki do bitów i nasadek | 30 |
| Rotary head ratchet handles<br>Grzechotki z obrotową głowicą          | 30 |

|   |   |       |
|---|---|-------|
| <b>Sockets 1/2"</b><br>Klucze nasadowe 1/2" |  | 35-36 |
|---|---|-------|

|  |    |
|--|----|
| Hexagonal sockets<br>Klucze nasadowe sześciokątne, krótkie     | 35 |
| Bi-hexagonal sockets<br>Klucze nasadowe dwunastokątne, krótkie | 35 |
| Spline sockets<br>Klucze nasadowe „Spline”                     | 35 |
| Hexagonal deep sockets<br>Klucze nasadowe sześciokątne, długie | 36 |

|   |   |    |
|---|---|----|
| <b>Sockets 3/8"</b><br>Klucze nasadowe 3/8" |  | 31 |
|---|---|----|

|  |    |
|--|----|
| Hexagonal sockets<br>Klucze nasadowe sześciokątne, krótkie     | 31 |
| Hexagonal deep sockets<br>Klucze nasadowe sześciokątne, długie | 31 |

|   |   |       |
|---|---|-------|
| <b>Accessories 1/2"</b><br>Akcesoria 1/2" |  | 36-37 |
|---|---|-------|

|   |    |
|---|----|
| Extension bars<br>Przedłużki                      | 36 |
| Extension bars with wobble<br>Przedłużki uchylnie | 36 |
| Adapters<br>Redukcje                              | 37 |
| Bit adapters<br>Adaptery do bitów                 | 37 |
| Universal joints<br>Przeguby Cardana              | 37 |
| Sliding T-bars<br>Pokręta typu „T”                | 37 |
| Flexible handles<br>Pokręta łamane                | 37 |
| L-type handles<br>Pokręta typu „L”                | 37 |
| Spark plug sockets<br>Klucze nasadowe do świec    | 37 |







|   |   |       |
|---|---|-------|
| <b>Accessories 3/8"</b><br>Akcesoria 3/8" |  | 31-32 |
|---|---|-------|

|   |    |
|---|----|
| Extension bars<br>Przedłużki                      | 31 |
| Extension bars with wobble<br>Przedłużki uchylnie | 31 |
| Adapters<br>Redukcje                              | 32 |

|  |   |       |
|--|---|-------|
| <b>Ratchet handles 1/2"</b><br>Grzechotki 1/2" |  | 38-39 |
|--|---|-------|

|  |    |
|--|----|
| Ratchet handles<br>Grzechotki                      | 38 |
| Flexible ratchet handles<br>Grzechotki z przegubem | 38 |



|  |       |  |       |   |
|--|-------|--|-------|---|
| Composite ratchet handles<br>Grzechotki powlekane.....                     | 38    | Go-trough socket sets 1/2"<br>Zestawy kluczy nasadowych, przelotowych 1/2"           | 70    |    |
| Curved ratchet handles<br>Grzechotki wygięte.....                          | 39    |  |       |   |
| Telescopic ratchet handles<br>Grzechotki z przedłużonym uchwytem.....      | 39    |  |       |   |
| Rotary head ratchet handles<br>Grzechotki z obrotową głowicą.....          | 39    | Sockets 3/4"<br>Klucze nasadowe 3/4"   | 71    |    |
| <b>Socket sets</b><br>Zestawy kluczy nasadowych                            | 40-50 | <b>Accessories 3/4"</b><br>Akcesoria 3/4"  | 71-72 |    |
| Socket sets 1/4"<br>Zestawy kluczy nasadowych 1/4"                         | 40    | Extension bars<br>Przedłużki.....  | 71    |   |
| Socket sets 3/8"<br>Zestawy kluczy nasadowych 3/8"                         | 41    | Adapters<br>Redukcje.....  | 71    |   |
| Socket sets 1/2"<br>Zestawy kluczy nasadowych 1/2"                         | 42    | Universal joints<br>Przeguby Cardana.....  | 71    |   |
| Socket sets 1/2", 1/4"<br>Zestawy kluczy nasadowych 1/2", 1/4"             | 43    | Sliding T-bars<br>Pokręta typu „T”.....  | 71    |   |
| Socket sets 1/2", 3/8", 1/4"<br>Zestawy kluczy nasadowych 1/2", 3/8", 1/4" | 46    | Flexible handles<br>Pokręta łamane.....  | 72    |   |
| <b>Socket sets</b><br>Zestawy kluczy nasadowych                            | 51-69 | L-type handles<br>Pokręta typu „L”.....  | 72    |   |
| Socket sets 1/4"<br>Zestawy kluczy nasadowych 1/4"                         | 51    | Ratchet handles 3/4"<br>Grzechotki 3/4"  | 72    |   |
| Socket sets 3/8"<br>Zestawy kluczy nasadowych 3/8"                         | 55    |  |       |   |
| Socket sets 1/2"<br>Zestawy kluczy nasadowych 1/2"                         | 57    | Socket sets 3/4"<br>Zestawy kluczy nasadowych 3/4"                                   | 72    |  |
| Socket sets 1/2", 1/4"<br>Zestawy kluczy nasadowych 1/2", 1/4"             | 61    |  |       |   |
| Socket sets 1/2", 3/8", 1/4"<br>Zestawy kluczy nasadowych 1/2", 3/8", 1/4" | 66    | Bit sockets & sets 1/4", 3/8", 1/2"<br>Klucze trzpieniowe i zestawy 1/4", 3/8", 1/2" | 73-75 |  |
| <b>Torx sockets &amp; sets</b><br>Klucze nasadowe „Torx” i zestawy         | 70    |  |       |   |



GB Hexagonal socket  
D Sechskantenschlüssel  
PL Nasadka sześciokątna  
RUS Головка шестигранная короткая  
CZ Šestihřanný nástavec  
H Hatszögű rátét  
RO Cheie tubulară hexagonală  
F Douille courte  
I Chiave a bussola esagonale  
E Boquilla hexagonal corta  
CN 六角套筒

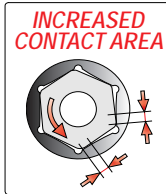

1/4"  
6.3mm  
DIN 3121  
CrV 50BV30  
AS-DRIVE

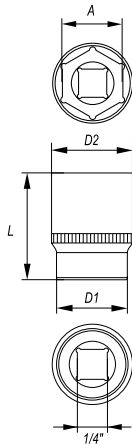

COLOR BOX

- drive locks
- surface finish: chromed, satin / mirror
- zamki blokujące
- wykończenie powierzchni: chromowana, satynowa / polerowana

| YATO    | ∅ A (mm) | D1 (mm) | D2 (mm) | L (mm) | PCS packing |         |
|---------|----------|---------|---------|--------|-------------|---------|
| YT-1401 | 4.0      | 7.0     | 12.0    | 25     | 20          | 200/400 |
| YT-1403 | 5.0      | 8.0     | 12.0    | 25     | 20          | 200/400 |
| YT-1404 | 5.5      | 8.5     | 12.0    | 25     | 20          | 200/400 |
| YT-1405 | 6.0      | 9.0     | 12.0    | 25     | 20          | 200/400 |
| YT-1406 | 7.0      | 10.0    | 12.0    | 25     | 20          | 200/400 |
| YT-1407 | 8.0      | 12.0    | 11.0    | 25     | 20          | 200/400 |
| YT-1408 | 9.0      | 13.0    | 12.0    | 25     | 20          | 200/400 |
| YT-1409 | 10.0     | 15.0    | 12.0    | 25     | 10          | 200/400 |
| YT-1410 | 11.0     | 16.0    | 14.0    | 25     | 10          | 200/400 |
| YT-1411 | 12.0     | 17.0    | 15.0    | 25     | 10          | 200/400 |
| YT-1412 | 13.0     | 18.0    | 16.0    | 25     | 10          | 200/400 |

GB Hexagonal deep socket  
D Sechskantenschlüssel, lange  
PL Nasadka sześciokątna długa  
RUS Головка шестигранная длинная  
CZ Šestihřanný hluboký nástavec  
H Hatszögű rátét mély  
RO Cheie tubulară hexagonală adâncă  
F Douille longue  
I Chiave a bussola esagonale  
E Boquilla hexagonal larga  
CN 六角长套筒

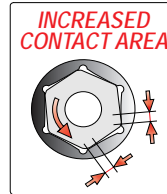

1/4"  
6.3mm  
DIN 3121  
CrV 50BV30  
AS-DRIVE

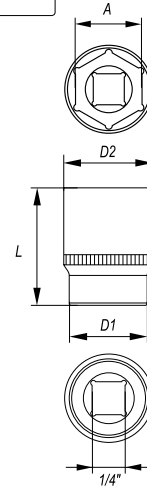

COLOR BOX

- drive locks
- surface finish: chromed, satin / mirror
- zamki blokujące
- wykończenie powierzchni: chromowana, satynowa / polerowana

| YATO    | ∅ A (mm) | D1 (mm) | D2 (mm) | L (mm) | PCS packing |         |
|---------|----------|---------|---------|--------|-------------|---------|
| YT-1413 | 4.0      | 7.0     | 12.0    | 50     | 10          | 200/400 |
| YT-1414 | 4.5      | 7.5     | 12.0    | 50     | 10          | 200/400 |
| YT-1415 | 5.0      | 8.0     | 12.0    | 50     | 10          | 200/400 |
| YT-1416 | 5.5      | 8.5     | 12.0    | 50     | 10          | 200/400 |
| YT-1417 | 6.0      | 9.0     | 12.0    | 50     | 10          | 200/400 |
| YT-1418 | 7.0      | 10.0    | 12.0    | 50     | 10          | 200/400 |
| YT-1419 | 8.0      | 12.0    | 12.0    | 50     | 10          | 200/400 |
| YT-1420 | 9.0      | 13.0    | 12.0    | 50     | 10          | 200/400 |
| YT-1421 | 10.0     | 14.0    | 13.0    | 50     | 10          | 200/400 |
| YT-1422 | 11.0     | 16.0    | 14.0    | 50     | 10          | 100/200 |
| YT-1423 | 12.0     | 17.0    | 15.0    | 50     | 10          | 100/200 |
| YT-1424 | 13.0     | 18.0    | 16.0    | 50     | 10          | 100/200 |

GB Extension bar  
D Verlängerung  
PL Przedłużka  
RUS Удлинитель для воротка  
CZ Prodlužovací přípravek  
H Toldalék  
RO Prelungitor  
F Rallonge  
I Prolunga  
E Tubo de prolongación desviable  
CN 转向接杆

1/4"  
6.3mm  
DIN 3121  
CrV 50BV30

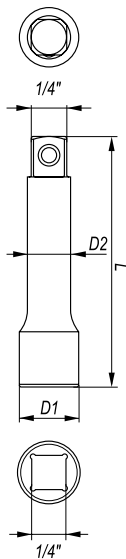

COLOR BOX

| YATO    | ∅             | D1 (mm) | D2 (mm) | L (mm) | PCS packing |         |
|---------|---------------|---------|---------|--------|-------------|---------|
| YT-1429 | 1/4" (6.3 mm) | 12.4    | 8.3     | 50.8   | 30          | 150/300 |
| YT-1430 | 1/4" (6.3 mm) | 12.4    | 8.3     | 76.0   | 30          | 150/300 |
| YT-1431 | 1/4" (6.3 mm) | 12.4    | 8.3     | 101.6  | 20          | 100/200 |
| YT-1432 | 1/4" (6.3 mm) | 12.4    | 8.3     | 152.4  | 20          | 100/200 |

GB Extension bar with wobble  
D Gelenverlängerung  
PL Przedłużka uchylna  
RUS Удлинитель наклонный  
CZ Odchylný prodlužovací přípravek  
H Csuklós toldalék  
RO Prelungitor rabatabil  
F Rallonge angulaire  
I Prolunga  
E Tubo de prolongación desviable  
CN 转向接杆

1/4"  
6.3mm  
DIN 3121  
CrV 50BV30

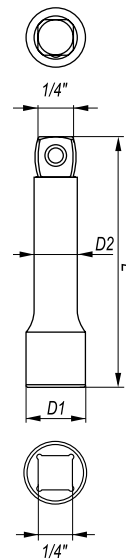

COLOR BOX

| YATO    | ∅             | D1 (mm) | D2 (mm) | L (mm) | PCS packing |         |
|---------|---------------|---------|---------|--------|-------------|---------|
| YT-1433 | 1/4" (6.3 mm) | 12.4    | 8.3     | 50.8   | 30          | 150/300 |
| YT-1434 | 1/4" (6.3 mm) | 12.4    | 8.3     | 76.0   | 30          | 150/300 |
| YT-1435 | 1/4" (6.3 mm) | 12.4    | 8.3     | 101.6  | 20          | 100/200 |
| YT-1436 | 1/4" (6.3 mm) | 12.4    | 8.3     | 152.4  | 20          | 100/200 |

- GB Extension bar  
D Verlängerung  
PL Przedłużka elastyczna  
RUS Удлинитель для воротка
- CZ Prodlužovací přípravek  
H Toldalék  
RO Prelungitor  
F Rallonge élastique
- I Prolunga flessibile  
E Tubo de prolongación  
CN 可弯式接杆

1/4"  
6.3mm  
CrV  
6140

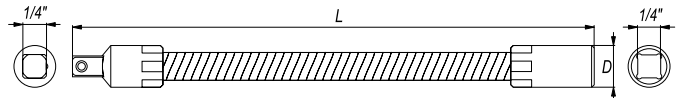

| YATO    | Ø             | Ø             | D (mm) | L (mm) | PCS packing |         |
|---------|---------------|---------------|--------|--------|-------------|---------|
| YT-1400 | 1/4" (6.3 mm) | 1/4" (6.3 mm) | 11.6   | 150    | 25          | 250/500 |

- GB Adapter  
D Reduktion  
PL Redukcja  
RUS Переходник  
CZ Redukce  
H Redukció  
RO Reducție  
F Réduction  
I Riduttore  
E Reducción  
CN 转换头

1/4"  
6.3mm  
DIN  
3121  
CrV  
50BV30

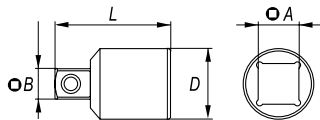

| YATO    | Ø A               | Ø B               | D (mm) | L (mm) | PCS packing |         |
|---------|-------------------|-------------------|--------|--------|-------------|---------|
| YT-1438 | 1/4" (6.3 mm) (F) | 3/8" (9.5 mm) (M) | 12     | 25     | 10          | 250/500 |

- GB Bit adapter  
D Bithalter  
PL Adapter do bitów  
RUS Держатель винтовёртовых наконечников  
CZ Držák na šroubovavkové koncovky  
H Szár a csavarhúzóvégekhez  
RO Capete șurubelniță  
F Adapteur d'embouts  
I Chiave esagonale a bussola  
E Mandril para puntas  
CN 旋具头接头

1/4"  
6.3mm  
CrV  
6140

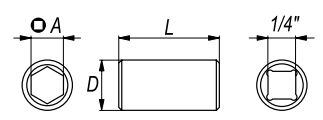

| YATO    | Ø             | Ø A           | D (mm) | L (mm) | PCS packing |         |
|---------|---------------|---------------|--------|--------|-------------|---------|
| YT-1297 | 1/4" (6.3 mm) | 1/4" (6.3 mm) | 11.8   | 24     | 10          | 250/500 |

- GB Universal joint  
D Kardangeln  
PL Przegub Cardana  
RUS Карданный шарнир  
CZ Kardanový kloub  
H Kardan csukló

- RO Articulație Cardanică  
F Cardan  
I Snodo cardanico  
E Articulación Cardan  
CN 万向接头

1/4"  
6.3mm  
DIN  
3121  
CrV  
50BV30

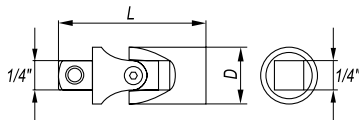

| YATO    | Ø             | D (mm) | L (mm) | PCS packing |         |
|---------|---------------|--------|--------|-------------|---------|
| YT-1437 | 1/4" (6.3 mm) | 14     | 35     | 20          | 120/240 |

- GB Spinner handle  
D Drehgriff für steckschlüssel  
PL Pokrętko do nasadek  
RUS Ручка с соединением под головки  
CZ Nástavec ruční na bity  
H Csavarhúzó hajtószar

- RO Prelungitor antrenor pt. biti  
F Barre  
I Porta bussola con manico  
E Destornillador con cuadradillo  
CN 旋柄

1/4"  
6.3mm  
CrV  
50BV30



| YATO    | Ø             | L (mm) | PCS packing |    |
|---------|---------------|--------|-------------|----|
| YT-1427 | 1/4" (6.3 mm) | 150    | 12          | 48 |

- GB Sliding T-bar  
D Handgriff mit Gleitstück  
PL Pokrętko typu „T”  
RUS Вороток Т-образный  
CZ Otočná račka typ „T”

- H „T” alakú hajtókar  
RO Mâner clupă tipul „T”  
F Barre type „T”  
I Manopola „T” scorrevole  
E Mango tipo „T”  
CN 滑行杆

1/4"  
6.3mm  
DIN  
3121  
CrV  
50BV30

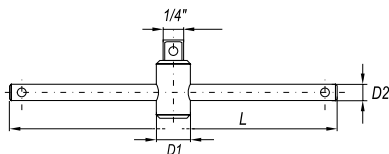

| YATO    | Ø             | D1 (mm) | D2 (mm) | L (mm) | PCS packing |         |
|---------|---------------|---------|---------|--------|-------------|---------|
| YT-1426 | 1/4" (6.3 mm) | 13.3    | 6.3     | 152.4  | 10          | 100/200 |

- GB Flexible handle  
D Gelenkgriff  
PL Pokrętko lamane  
RUS Вороток шарнирный  
CZ Otočná lomená ráčka  
H Hajlított hajtókar

- RO Prelungitor cu prindere flexibilă  
F Barre pivotante  
I Manopola a snodo  
E Mango articulado  
CN 转向手柄

1/4"  
6.3mm  
DIN  
3121  
CrV  
50BV30

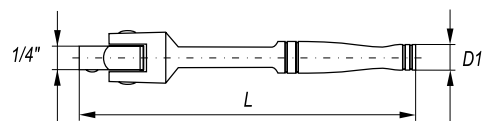

| YATO    | Ø             | D (mm) | L (mm) | PCS packing |         |
|---------|---------------|--------|--------|-------------|---------|
| YT-1425 | 1/4" (6.3 mm) | 13     | 140    | 10          | 100/200 |



GB Quick release ratchet handle  
D Hebelumschaltknarre  
PL Grzechotka  
RUS Трещотка  
CZ Řehtačka  
H Racsnis hajtókar

RO Dispozitiv de prindere cu clichet  
F Clé à cliquet  
I Cricchetto bussola  
E Carraca  
CN 快速脱落棘轮扳手

PLASTIC HANGER



12 PCS



COLOR BOX

1/4"  
6.3mm

DIN  
3122

QUICK  
RELEASE  
SZYBKO-  
ZŁĄCZE

72T

CrV  
6140

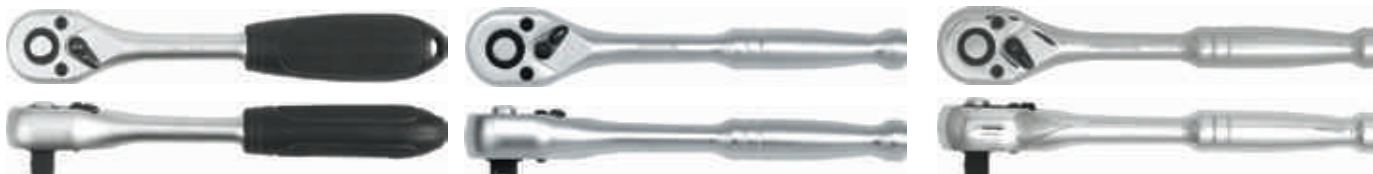

| YATO    | Ø             | T  | L (mm) | PCS packing: | Box   |
|---------|---------------|----|--------|--------------|-------|
| YT-0307 | 1/4" (6.3 mm) | 72 | 146    | 12           | 24/96 |

| YATO    | Ø             | T  | L (mm) | PCS packing: | Box   |
|---------|---------------|----|--------|--------------|-------|
| YT-0310 | 1/4" (6.3 mm) | 72 | 125    | 12           | 36/72 |

| YATO    | Ø             | T  | L (mm) | PCS packing: | Box   |
|---------|---------------|----|--------|--------------|-------|
| YT-0313 | 1/4" (6.3 mm) | 72 | 125    | 12           | 24/96 |



| YATO    | Ø             | T  | L (mm) | PCS packing: | Box   |
|---------|---------------|----|--------|--------------|-------|
| YT-0316 | 1/4" (6.3 mm) | 72 | 145    | 12           | 24/96 |

| YATO    | Ø             | T  | L (mm) | PCS packing: | Box   |
|---------|---------------|----|--------|--------------|-------|
| YT-0319 | 1/4" (6.3 mm) | 72 | 145    | 12           | 48/96 |

| YATO    | Ø             | T  | L (mm) | PCS packing: | Box   |
|---------|---------------|----|--------|--------------|-------|
| YT-0322 | 1/4" (6.3 mm) | 72 | 148    | 12           | 48/96 |

GB Quick release ratchet handle  
D Hebelumschaltknarre  
PL Grzechotka  
RUS Трещотка  
CZ Řehtačka  
H Racsnis hajtókar

RO Dispozitiv de prindere cu clichet  
F Clé à cliquet  
I Cricchetto bussola  
E Carraca  
CN 快速脱落棘轮扳手

PLASTIC HANGER



12 PCS



COLOR BOX

1/4"  
6.3mm

DIN  
3122

QUICK  
RELEASE  
SZYBKO-  
ZŁĄCZE

72T

CrV  
6140

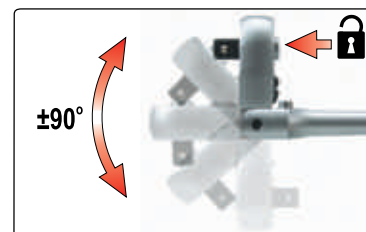

| YATO    | Ø             | T  | L (mm) | PCS packing: | Box   |
|---------|---------------|----|--------|--------------|-------|
| YT-0325 | 1/4" (6.3 mm) | 72 | 159    | 12           | 48/96 |

GB Quick release ratchet handle  
D Hebelumschaltknarre  
PL Grzechotka powlekana  
RUS Трещотка  
CZ Řehtačka  
H Racsnis hajtókar

RO Dispozitiv de prindere cu clichet  
F Clé à cliquet  
I Cricchetto bussola  
E Carraca  
CN 快速脱落棘轮扳手

PLASTIC HANGER



12 PCS



COLOR BOX

1/4"  
6.3mm

DIN  
3122

QUICK  
RELEASE  
SZYBKO-  
ZŁĄCZE

72T

CrV  
6135



| YATO    | Ø             | T  | L (mm) | PCS packing: | Box   |
|---------|---------------|----|--------|--------------|-------|
| YT-0290 | 1/4" (6.3 mm) | 72 | 144    | 12           | 48/96 |

| YATO    | Ø             | T  | L (mm) | PCS packing: | Box   |
|---------|---------------|----|--------|--------------|-------|
| YT-0293 | 1/4" (6.3 mm) | 72 | 144    | 12           | 48/96 |



GB Quick release ratchet handle  
 D Hebelumschaltknarre  
 PL Grzechotka  
 RUS Трещотка  
 CZ Řehtačka  
 H Racsnis hajtókar  
 RO Dispozitiv de prindere cu clichet  
 F Clé à cliquet  
 I Cricchetto bussola  
 E Carraca  
 CN 快速脱落棘轮扳手

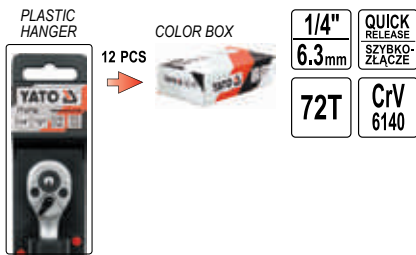

1/4" QUICK RELEASE SZYBKO-ZŁĄCZE  
 6.3mm  
 72T  
 CrV 6140



| YATO    | Ø             | T  | L (mm) | PCS packing: |       |
|---------|---------------|----|--------|--------------|-------|
| YT-0730 | 1/4" (6.3 mm) | 72 | 155    | 12           | 24/96 |

GB Quick release ratchet handle  
 D Hebelumschaltknarre  
 PL Grzechotka  
 RUS Трещотка  
 CZ Řehtačka  
 H Racsnis hajtókar  
 RO Dispozitiv de prindere cu clichet  
 F Clé à cliquet  
 I Cricchetto bussola  
 E Carraca  
 CN 快速脱落棘轮扳手

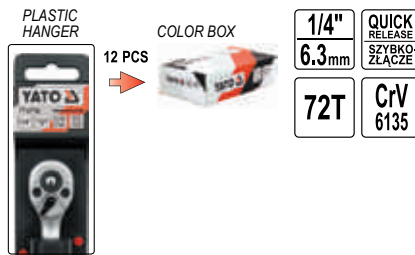

1/4" QUICK RELEASE SZYBKO-ZŁĄCZE  
 6.3mm  
 72T  
 CrV 6135



| YATO    | Ø             | T  | L (mm) | PCS packing: |       |
|---------|---------------|----|--------|--------------|-------|
| YT-0733 | 1/4" (6.3 mm) | 72 | 155    | 12           | 24/96 |

GB Telescopic ratchet handle  
 D Umschaltknarre  
 PL Grzechotka z przedłużanym uchwytem  
 RUS Трещотка  
 CZ Řehtačka  
 H Racsnis hajtókar  
 RO Antrenor cu clichet  
 F Clé à cliquet  
 I Cricchetto bussola  
 E Carraca telescópico  
 CN 可伸缩快速脱落棘轮扳手

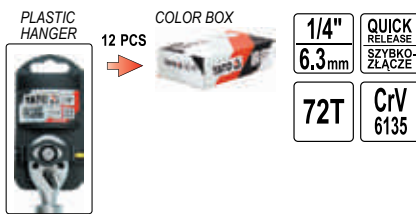

1/4" QUICK RELEASE SZYBKO-ZŁĄCZE  
 6.3mm  
 72T  
 CrV 6135



| YATO    | Ø             | T  | L (mm)  | PCS packing: |    |
|---------|---------------|----|---------|--------------|----|
| YT-0297 | 1/4" (6.3 mm) | 72 | 150-200 | 12           | 48 |

GB Ratchet handle and bit drive  
 D Bit- und Steckschlüssel-Umschaltknarre  
 PL Grzechotka do bitów i nasadek  
 RUS Трещотка для битов и головок  
 CZ Ráčna kombinovaná pro bity a nástrčné kľíče  
 H Bit és dugófej behajtó racsnis hajtókar  
 RO Antrenor cu clichet / antrenor pt. biti  
 F Clé à cliquet  
 I Cricchetto bussola per punte e snodi  
 E Carraca para boquillas y puntas  
 CN 套筒旋具两用棘轮扳手

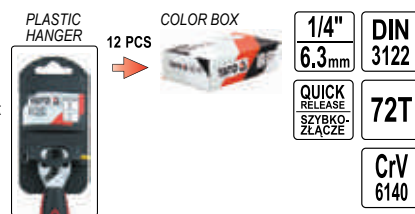

1/4" DIN 3122  
 6.3mm  
 QUICK RELEASE SZYBKO-ZŁĄCZE  
 72T  
 CrV 6140



| YATO    | Ø             | T  | L (mm) | PCS packing: |    |
|---------|---------------|----|--------|--------------|----|
| YT-0331 | 1/4" (6.3 mm) | 72 | 136    | 12           | 48 |

GB Swivel ratchet handle for bits and sockets  
 D Umschaltknarre mit Außenvierkanttrieb  
 PL Grzechotka z obrotową głowicą do bitów i nasadek  
 RUS Трещетка реверсивная  
 CZ Ráčna s otočnou hlavou  
 H Forgófejes racsnis szár  
 RO Antrenor cu clichet flexibil  
 F Cricchetto bussola per punte e snodi  
 I Cricchetto bussola per punte e snodi  
 E Carraca con cabeza giratoria  
 CN 旋轉頭套筒旋具兩用棘輪扳手

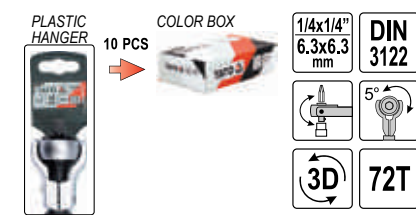

1/4x1/4" DIN 3122  
 6.3x6.3 mm  
 5°  
 3D  
 72T  
 CrV 6140



| YATO     | Ø                             | T  | L (mm) | PCS packing: |     |
|----------|-------------------------------|----|--------|--------------|-----|
| YT-03311 | 1/4" (6.3 mm) x 1/4" (6.3 mm) | 72 | 115    | 10           | 100 |

GB Flexible ratchet handle / round head  
 D Flexible Drehkopfratsche  
 PL Grzechotka z obrotową głowicą  
 RUS Трещетка с вращательной головкой  
 CZ Ráčna s otočnou hlavou  
 H Forgófejes racsnis szár  
 RO Antrenor cu clichet flexibil  
 F Clé à cliquet tête pivotante  
 I Cricchetto bussola reversibile con ghiera  
 E Carraca con cabeza giratoria  
 CN 旋转头快速脱落棘轮扳手

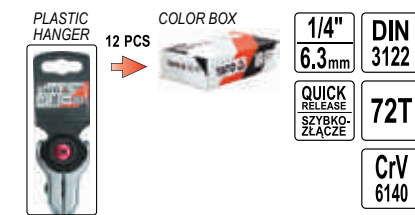

1/4" DIN 3122  
 6.3mm  
 QUICK RELEASE SZYBKO-ZŁĄCZE  
 72T  
 CrV 6140



| YATO    | Ø             | T  | L (mm) | PCS packing: |       |
|---------|---------------|----|--------|--------------|-------|
| YT-0720 | 1/4" (6.3 mm) | 72 | 145    | 12           | 24/96 |



GB Hexagonal socket  
D Sechskantenschlüssel  
PL Nasadka sześciokątna  
RUS Головка шестигранная короткая  
CZ Šestihřanný nástavec  
H Hatszögű rátét  
RO Cheie tubulară hexagonală  
F Douille courte  
I Chiave a bussola esagonale  
E Boquilla hexagonal corta  
CN 六角套筒

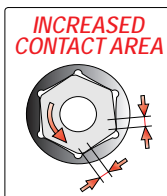
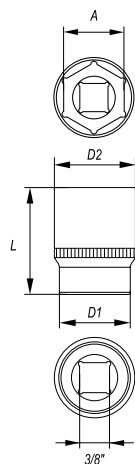

3/8" 10mm  
DIN 3121  
CrV 50BV30  
AS-DRIVE

- drive locks
- surface finish: chromed, satin / mirror
- zamki blokujące
- wykończenie powierzchni: chromowana, satynowa / polerowana



| YATO    | Ø A (mm) | D1 (mm) | D2 (mm) | L (mm) | PCS packing |         |
|---------|----------|---------|---------|--------|-------------|---------|
| YT-3801 | 6        | 10      | 17      | 28     | 10          | 250/500 |
| YT-3802 | 7        | 11      | 17      | 28     | 10          | 250/500 |
| YT-3803 | 8        | 12      | 17      | 28     | 10          | 250/500 |
| YT-3804 | 9        | 13      | 17      | 28     | 10          | 250/500 |
| YT-3805 | 10       | 14      | 17      | 28     | 10          | 250/500 |
| YT-3806 | 11       | 16      | 17      | 28     | 10          | 250/500 |
| YT-3807 | 12       | 18      | 17      | 28     | 10          | 250/500 |
| YT-3808 | 13       | 19      | 18      | 28     | 10          | 150/300 |
| YT-3809 | 14       | 20      | 19      | 28     | 10          | 150/300 |
| YT-3810 | 15       | 21      | 19      | 28     | 10          | 100/500 |
| YT-3811 | 16       | 22      | 21      | 28     | 10          | 100/500 |
| YT-3812 | 17       | 24      | 22      | 30     | 10          | 100/200 |
| YT-3813 | 18       | 25      | 23      | 30     | 10          | 100/200 |
| YT-3814 | 19       | 26      | 24      | 30     | 10          | 100/200 |

GB Hexagonal deep socket  
D Sechskantenschlüssel, lange  
PL Nasadka sześciokątna długa  
RUS Головка шестигранная длинная  
CZ Šestihřanný hluboký nástavec  
H Hatszögű rátét mély  
RO Cheie tubulară hexagonală adâncă  
F Douille longue  
I Chiave a bussola esagonale  
E Boquilla hexagonal larga  
CN 六角长套筒

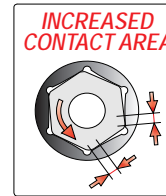
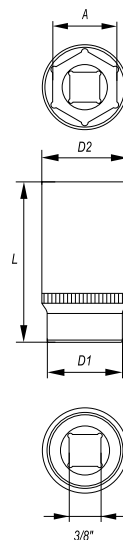

3/8" 10mm  
DIN 3121  
CrV 50BV30  
AS-DRIVE

- drive locks
- surface finish: chromed, satin / mirror
- zamki blokujące
- wykończenie powierzchni: chromowana, satynowa / polerowana



| YATO    | Ø A (mm) | D1 (mm) | D2 (mm) | L (mm) | PCS packing |        |
|---------|----------|---------|---------|--------|-------------|--------|
| YT-3820 | 6        | 10      | 17      | 63     | 10          | 50/100 |
| YT-3821 | 7        | 10      | 17      | 63     | 10          | 50/100 |
| YT-3822 | 8        | 12      | 17      | 63     | 10          | 50/100 |
| YT-3823 | 9        | 13      | 17      | 63     | 10          | 50/100 |
| YT-3824 | 10       | 14      | 17      | 63     | 10          | 50/100 |
| YT-3825 | 11       | 16      | 17      | 63     | 10          | 50/100 |
| YT-3826 | 12       | 18      | 17      | 63     | 10          | 50/100 |
| YT-3827 | 13       | 19      | 17      | 63     | 10          | 50/100 |
| YT-3828 | 14       | 20      | 19      | 63     | 10          | 50/100 |
| YT-3829 | 15       | 21      | 19      | 63     | 10          | 50/100 |
| YT-3830 | 16       | 22      | 20      | 63     | 10          | 50/100 |
| YT-3831 | 17       | 24      | 23      | 63     | 10          | 50/100 |
| YT-3832 | 18       | 25      | 23      | 63     | 10          | 50/100 |
| YT-3833 | 19       | 26      | 24      | 63     | 10          | 50/100 |

GB Extension bar  
D Verlängerung  
PL Przedłużka  
RUS Удлинитель для воротка  
CZ Prodlužovací přípravek  
H Toldalék  
RO Prelungitor  
F Rallonge  
I Prolunga  
E Tubo de prolongación  
CN 接杆

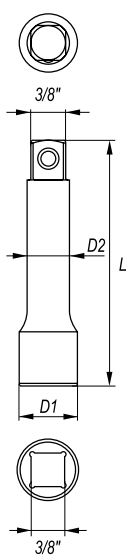

3/8" 10mm  
DIN 3121  
CrV 50BV30



| YATO    | Ø             | D1 (mm) | D2 (mm) | L (mm) | PCS packing |         |
|---------|---------------|---------|---------|--------|-------------|---------|
| YT-3842 | 3/8" (9.5 mm) | 18.0    | 12.3    | 42.0   | 10          | 100/200 |
| YT-3843 | 3/8" (9.5 mm) | 18.0    | 12.3    | 76.0   | 10          | 100/200 |
| YT-3844 | 3/8" (9.5 mm) | 18.0    | 12.3    | 152.4  | 10          | 50/100  |
| YT-3845 | 3/8" (9.5 mm) | 18.0    | 12.3    | 254.0  | 10          | 50      |

GB Extension bar with wobble  
D Gelenkverlängerung  
PL Przedłużka uchylna  
RUS Удлинитель наклонный  
CZ Odchylný prodlužovací přípravek  
H Csuklós toldalék  
RO Prelungitor rabatabil  
F Rallonge angulaire  
I Prolunga  
E Tubo de prolongación desviable  
CN 转向接杆

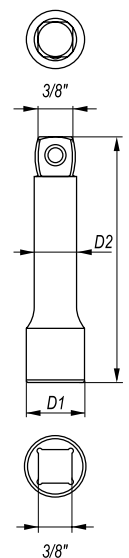

3/8" 10mm  
DIN 3121  
CrV 50BV30



| YATO    | Ø             | D1 (mm) | D2 (mm) | L (mm) | PCS packing |         |
|---------|---------------|---------|---------|--------|-------------|---------|
| YT-3847 | 3/8" (9.5 mm) | 18.0    | 12.3    | 76.0   | 10          | 100/200 |
| YT-3848 | 3/8" (9.5 mm) | 18.0    | 12.3    | 152.4  | 10          | 50/100  |
| YT-3849 | 3/8" (9.5 mm) | 18.0    | 12.3    | 254.0  | 10          | 50      |

GB Adapter  
D Reduktion  
PL Redukcja  
RUS Переходник  
CZ Redukce  
H Redukció  
RO Reducție  
F Réduction  
I Riduttore  
E Reducción  
CN 转换头

3/8" 10mm  
DIN 3121  
CrV 50BV30

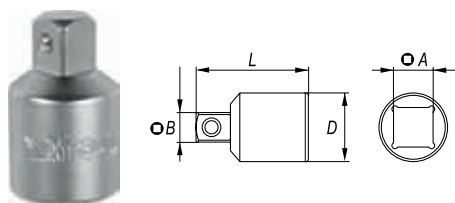

COLOR BOX

| YATO    | A                 | B                  | D (mm) | L (mm) | PCS packing |         |
|---------|-------------------|--------------------|--------|--------|-------------|---------|
| YT-3853 | 3/8" (9.5 mm) (F) | 1/4" (6.3 mm) (M)  | 17     | 27     | 10          | 250/500 |
| YT-3854 | 3/8" (9.5 mm) (F) | 1/2" (12.7 mm) (M) | 17     | 35     | 10          | 100/200 |

GB Universal joint  
D Kardangelenk  
PL Przegub Cardana  
RUS Карданный шарнир  
CZ Kardanový kloub  
H Kardán csukló

RO Articulație Cardanică  
F Cardan  
I Snodo cardanico  
E Articulación Cardan  
CN 万向接头

3/8" 10mm  
DIN 3121  
CrV 50BV30

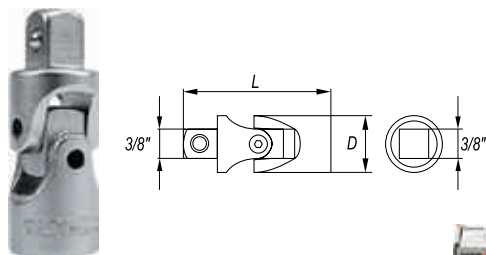

COLOR BOX

| YATO    | A             | D (mm) | L (mm) | PCS packing |         |
|---------|---------------|--------|--------|-------------|---------|
| YT-3850 | 3/8" (9.5 mm) | 18     | 49     | 10          | 100/200 |

GB Flexible handle  
D Gelenkgriff  
PL Pokręto łamane  
RUS Вороток шарнирный  
CZ Otočná lomená rāčka  
H Hajlított hajtókár  
RO Prelungitor cu prindere flexibilă  
F Barre pivotante  
I Manopola a snodo  
E Mango articulado  
CN 转向手柄

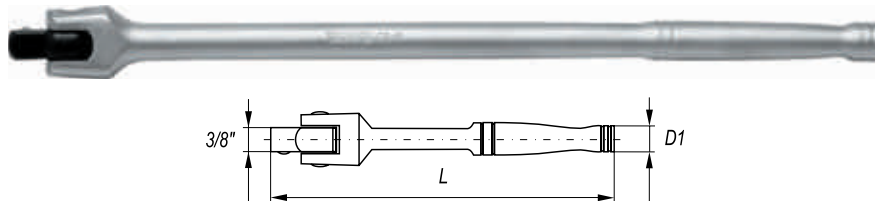

3/8" 10mm  
DIN 3121  
CrV 50BV30

COLOR BOX

| YATO    | A             | D (mm) | L (mm) | PCS packing |       |
|---------|---------------|--------|--------|-------------|-------|
| YT-3839 | 3/8" (9.5 mm) | 16     | 215    | 8           | 24/48 |

GB Spark plug socket  
D Steckschlüssel mit Gummihalterung  
PL Nasadka do świec  
RUS Головка свечная  
CZ Nastavec pro svíčky

H Gyújtógyertya toldalék  
RO Cheie de bujii  
F Douille à bougies  
I Chiavi a bussola  
E Boquilla de bujías  
CN 六角火花塞套筒

3/8" 10mm  
DIN 3121  
AS-DRIVE CrV 50BV30

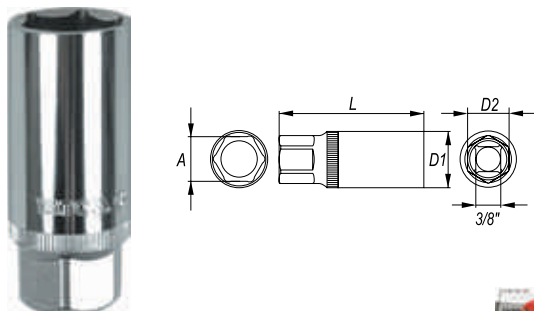

COLOR BOX

| YATO    | A             | D1 (mm) | D2 (mm) | L (mm) | PCS packing |           |
|---------|---------------|---------|---------|--------|-------------|-----------|
| YT-3851 | 3/8" (9.5 mm) | 16.0    | 22.0    | 19.0   | 64.0        | 10 50/100 |

GB Bit adapter  
D Bithalter  
PL Adapter do bitów  
RUS Держатель винтовёртовых наконечников  
CZ Držák na šroubovakové koncovky  
H Szár a csavarhúzóvégekhez  
RO Capete șurubelniță  
F Adapteur d'embouts  
I Chiave esagonale a bussola  
E Mandril para puntas  
CN 旋具头接头

3/8" 10mm  
CrV 6140

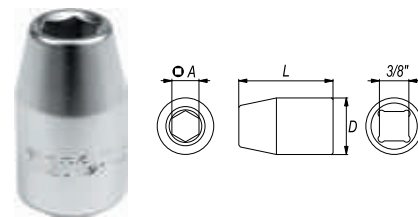

COLOR BOX

| YATO    | A             | D (mm) | L (mm) | PCS packing |            |
|---------|---------------|--------|--------|-------------|------------|
| YT-1296 | 3/8" (9.5 mm) | 8 mm   | 17.9   | 30          | 10 250/500 |

GB Sliding T-bar  
D Handgriff mit Gleitstück  
PL Pokręto typu „T”  
RUS Вороток Т-образный

CZ Otočná ráčka typ „T”  
H „T” alakú hajtókár mit Gleitstück  
RO Măner clupă tipul „T”  
F Barre type „T”

I Manopola „T” scorrevole  
E Mango tipo „T”  
CN 滑行杆

3/8" 10mm

DIN 3121

CrV 50BV30

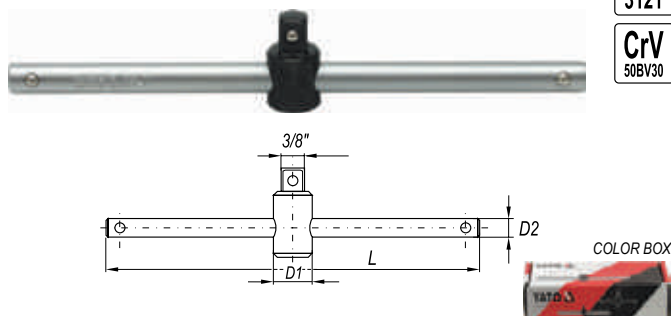

COLOR BOX

| YATO    | A             | D1 (mm) | D2 (mm) | L (mm) | PCS packing |        |
|---------|---------------|---------|---------|--------|-------------|--------|
| YT-3840 | 3/8" (9.5 mm) | 20.0    | 10.7    | 198    | 10          | 50/100 |

GB Spark plug socket  
D Steckschlüssel mit Gummihalterung  
PL Nasadka do świec  
RUS Головка свечная  
CZ Nastavec pro svíčky

H Gyújtógyertya toldalék  
RO Cheie de bujii  
F Douille à bougies  
I Chiavi a bussola  
E Boquilla de bujías  
CN 六角火花塞套筒

3/8" 10mm  
DIN 3121  
AS-DRIVE CrV 50BV30

GB Spark plug socket  
D Steckschlüssel mit Gummihalterung  
PL Nasadka do świec  
RUS Головка свечная  
CZ Nastavec pro svíčky

H Gyújtógyertya toldalék  
RO Cheie de bujii  
F Douille à bougies  
I Chiavi a bussola  
E Boquilla de bujías  
CN 六角火花塞套筒

3/8" 10mm  
DIN 3124  
AS-DRIVE CrV 6140

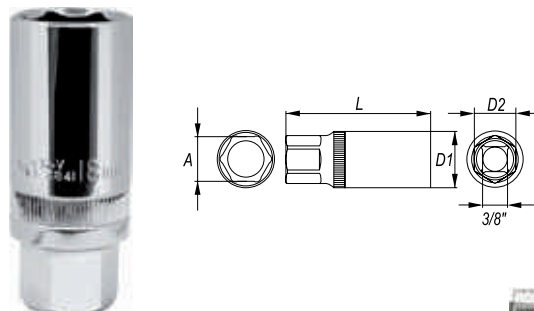

COLOR BOX

| YATO    | A             | D1 (mm) | D2 (mm) | L (mm) | PCS packing |           |
|---------|---------------|---------|---------|--------|-------------|-----------|
| YT-3841 | 3/8" (9.5 mm) | 18.0    | 25.8    | 19.0   | 63          | 25 50/100 |



GB Quick release ratchet handle  
 D Hebelumschaltknarre  
 PL Grzechotka  
 RUS Трещотка  
 CZ Řehtačka  
 H Racsnis hajtókar

RO Dispozitiv de prindere cu clichet  
 F Clé à cliquet  
 I Cricchetto bussola  
 E Carraca  
 CN 快速脱落棘轮扳手

PLASTIC HANGER



6 PCS



COLOR BOX

3/8"  
10mm

DIN  
3122

QUICK  
RELEASE  
SZYBKO-  
ZŁĄCZE

72T

CrV  
6140



| YATO    | Ø             | T  | L (mm) | PCS packing: |       |
|---------|---------------|----|--------|--------------|-------|
| YT-0308 | 3/8" (9.5 mm) | 72 | 185    | 6            | 24/48 |

| YATO    | Ø             | T  | L (mm) | PCS packing: |       |
|---------|---------------|----|--------|--------------|-------|
| YT-0311 | 3/8" (9.5 mm) | 72 | 200    | 6            | 18/36 |

| YATO    | Ø             | T  | L (mm) | PCS packing: |       |
|---------|---------------|----|--------|--------------|-------|
| YT-0314 | 3/8" (9.5 mm) | 72 | 170    | 6            | 24/48 |



| YATO    | Ø             | T  | L (mm) | PCS packing: |       |
|---------|---------------|----|--------|--------------|-------|
| YT-0317 | 3/8" (9.5 mm) | 72 | 200    | 6            | 24/48 |

| YATO    | Ø             | T  | L (mm) | PCS packing: |       |
|---------|---------------|----|--------|--------------|-------|
| YT-0320 | 3/8" (9.5 mm) | 72 | 205    | 6            | 24/48 |

| YATO    | Ø             | T  | L (mm) | PCS packing: |       |
|---------|---------------|----|--------|--------------|-------|
| YT-0323 | 3/8" (9.5 mm) | 72 | 197    | 6            | 24/48 |

GB Quick release ratchet handle  
 D Hebelumschaltknarre  
 PL Grzechotka  
 RUS Трещотка  
 CZ Řehtačka  
 H Racsnis hajtókar

RO Dispozitiv de prindere cu clichet  
 F Clé à cliquet  
 I Cricchetto bussola  
 E Carraca  
 CN 快速脱落棘轮扳手

PLASTIC HANGER



6 PCS



COLOR BOX

3/8"  
10mm

QUICK  
RELEASE  
SZYBKO-  
ZŁĄCZE

DIN  
3122

72T

CrV  
6140

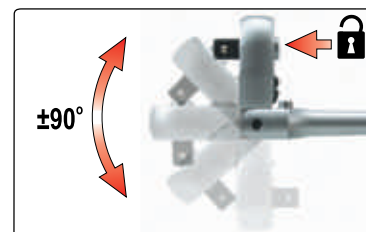

| YATO    | Ø             | T  | L (mm) | PCS packing: |       |
|---------|---------------|----|--------|--------------|-------|
| YT-0326 | 3/8" (9.5 mm) | 72 | 242    | 6            | 24/48 |

GB Quick release ratchet handle  
 D Hebelumschaltknarre  
 PL Grzechotka powlekana  
 RUS Трещотка  
 CZ Řehtačka  
 H Racsnis hajtókar

RO Dispozitiv de prindere cu clichet  
 F Clé à cliquet  
 I Cricchetto bussola  
 E Carraca  
 CN 快速脱落棘轮扳手

PLASTIC HANGER



6 PCS



COLOR BOX

3/8"  
10mm

DIN  
3122

QUICK  
RELEASE  
SZYBKO-  
ZŁĄCZE

72T

CrV  
6135



| YATO    | Ø             | T  | L (mm) | PCS packing: |       |
|---------|---------------|----|--------|--------------|-------|
| YT-0291 | 3/8" (9.5 mm) | 72 | 202    | 6            | 24/48 |

| YATO    | Ø             | T  | L (mm) | PCS packing: |       |
|---------|---------------|----|--------|--------------|-------|
| YT-0294 | 3/8" (9.5 mm) | 72 | 202    | 6            | 24/48 |

- GB Quick release ratchet handle
- D Hebelumschaltknarre
- PL Grzechotka
- RUS Трещотка
- CZ Řehtačka
- H Racsnis hajtókar
- RO Dispozitiv de prindere cu clichet
- F Clé à cliquet
- I Cricchetto bussola
- E Carraca
- CN 快速脱落棘轮扳手



6 PCS



**3/8"**  
**10mm**  
**72T**  
**CrV 6140**

- GB Quick release ratchet handle
- D Hebelumschaltknarre
- PL Grzechotka
- RUS Трещотка
- CZ Řehtačka
- H Racsnis hajtókar
- RO Dispozitiv de prindere cu clichet
- F Clé à cliquet
- I Cricchetto bussola
- E Carraca
- CN 快速脱落棘轮扳手



6 PCS



**3/8"**  
**10mm**  
**72T**  
**CrV 6135**



| YATO    | Ø             | T  | L (mm) | PCS packing: | Box   |
|---------|---------------|----|--------|--------------|-------|
| YT-0731 | 3/8" (9.5 mm) | 72 | 200    | 6            | 24/48 |

| YATO    | Ø             | T  | L (mm) | PCS packing: | Box   |
|---------|---------------|----|--------|--------------|-------|
| YT-0734 | 3/8" (9.5 mm) | 72 | 200    | 6            | 24/48 |

- GB Telescopic ratchet handle
- D Umschaltknarre
- PL Grzechotka z przedłużanym uchwytem
- RUS Трещотка
- CZ Řehtačka
- H Racsnis hajtókar
- RO Antrenor cu clichet
- F Clé à cliquet
- I Cricchetto bussola
- E Carraca telescópico
- CN 可伸缩快速脱落棘轮扳手



**3/8"**  
**10mm**  
**72T**  
**CrV 6135**



6 PCS

COLOR BOX



| YATO    | Ø             | T  | L (mm)  | PCS packing: | Box |
|---------|---------------|----|---------|--------------|-----|
| YT-0298 | 3/8" (9.5 mm) | 72 | 215-315 | 6            | 24  |



GB Hexagonal socket  
 D Sechskantenschlüssel  
 PL Nasadka sześciokątna  
 RUS Головка шестигранная короткая  
 CZ Šestihřanný nástavec  
 H Hatszögű rátét  
 RO Cheie tubulară hexagonală  
 F Douille courte  
 I Chiave a bussola esagonale  
 E Boquilla hexagonal corta  
 CN 六角套筒

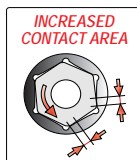

1/2" DIN 3121  
 12.5mm  
 CrV 50BV30 AS-DRIVE

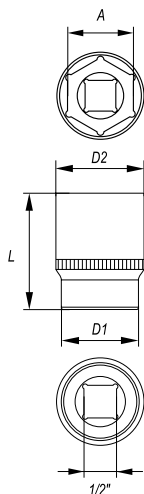

- drive locks
- surface finish: chromed, satin / mirror
- zamki blokujące
- wykończenie powierzchni: chromowana, satynowa / polerowana

COLOR BOX



| YATO    | ∅ A (mm) | D1 (mm) | D2 (mm) | L (mm) | PCS packing |         |
|---------|----------|---------|---------|--------|-------------|---------|
| YT-1201 | 8        | 12      | 22      | 38     | 10          | 100/200 |
| YT-1202 | 9        | 14      | 22      | 38     | 10          | 100/200 |
| YT-1203 | 10       | 15      | 22      | 38     | 10          | 100/200 |
| YT-1204 | 11       | 16      | 22      | 38     | 10          | 100/200 |
| YT-1205 | 12       | 18      | 22      | 38     | 10          | 100/200 |
| YT-1206 | 13       | 19      | 22      | 38     | 10          | 100/200 |
| YT-1207 | 14       | 20      | 22      | 38     | 10          | 100/200 |
| YT-1208 | 15       | 21      | 22      | 38     | 10          | 100/200 |
| YT-1209 | 16       | 23      | 22      | 38     | 10          | 100/200 |
| YT-1210 | 17       | 24      | 23      | 38     | 10          | 100/200 |
| YT-1211 | 18       | 25      | 23      | 38     | 10          | 100/200 |
| YT-1212 | 19       | 27      | 24      | 38     | 10          | 100/200 |
| YT-1213 | 20       | 28      | 24      | 38     | 10          | 100/200 |
| YT-1214 | 21       | 29      | 24      | 38     | 10          | 100/200 |
| YT-1215 | 22       | 30      | 26      | 38     | 10          | 100/200 |
| YT-1216 | 23       | 31      | 28      | 38     | 10          | 50/100  |
| YT-1217 | 24       | 32      | 28      | 38     | 10          | 50/100  |
| YT-1218 | 27       | 36      | 30      | 42     | 10          | 50/100  |
| YT-1219 | 30       | 40      | 34      | 42     | 10          | 50/100  |
| YT-1220 | 32       | 42      | 36      | 42     | 10          | 50/100  |

GB Bi-hexagonal socket  
 D Zwölfkant-Steckschlüssel-Einsatz  
 PL Nasadka dwunastokątna  
 RUS Головка 12-гранная  
 CZ Nástrčný ořech dvanáctihřanný  
 H Dugófej, 12 lapú  
 RO Cheie tubulară bihexagonală  
 F Douille courte  
 I Chiave a bussola esagonale  
 E Boquilla de anillo  
 CN 十二角套筒

1/2" DIN 3121  
 12.5mm  
 CrV 50BV30 AS-DRIVE

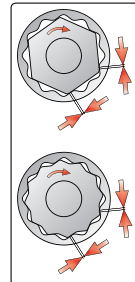
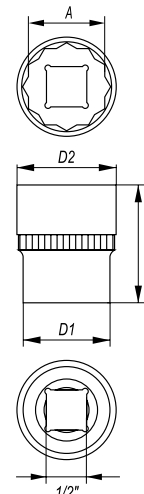

- drive locks
- surface finish: chromed, satin / mirror
- zamki blokujące
- wykończenie powierzchni: chromowana, satynowa / polerowana

COLOR BOX



| YATO    | ∅ A (mm) | D1 (mm) | D2 (mm) | L (mm) | PCS packing |         |
|---------|----------|---------|---------|--------|-------------|---------|
| YT-1270 | 8        | 12      | 22      | 38     | 10          | 100/200 |
| YT-1271 | 9        | 14      | 22      | 38     | 10          | 100/200 |
| YT-1272 | 10       | 15      | 22      | 38     | 10          | 100/200 |
| YT-1273 | 11       | 16      | 22      | 38     | 10          | 100/200 |
| YT-1274 | 12       | 17      | 22      | 38     | 10          | 100/200 |
| YT-1275 | 13       | 19      | 22      | 38     | 10          | 100/200 |
| YT-1276 | 14       | 20      | 22      | 38     | 10          | 100/200 |
| YT-1277 | 15       | 21      | 22      | 38     | 10          | 100/200 |
| YT-1278 | 16       | 23      | 22      | 38     | 10          | 100/200 |
| YT-1279 | 17       | 24      | 22      | 38     | 10          | 100/200 |
| YT-1280 | 18       | 25      | 23      | 38     | 10          | 100/200 |
| YT-1281 | 19       | 27      | 24      | 38     | 10          | 100/200 |
| YT-1282 | 20       | 28      | 24      | 38     | 10          | 100/200 |
| YT-1283 | 21       | 29      | 24      | 38     | 10          | 100/200 |
| YT-1284 | 22       | 30      | 26      | 38     | 10          | 100/200 |
| YT-1285 | 23       | 31      | 28      | 38     | 10          | 50/100  |
| YT-1286 | 24       | 32      | 28      | 38     | 10          | 50/100  |
| YT-1289 | 27       | 36      | 30      | 42     | 10          | 50/100  |
| YT-1291 | 30       | 40      | 34      | 42     | 10          | 50/100  |
| YT-1292 | 32       | 42      | 36      | 42     | 10          | 50/100  |

GB Spline socket  
 D Steckschlüssel Spline  
 PL Nasadka Spline  
 RUS Головка Spline  
 CZ Nástrčný klíč profil Spline  
 H Spline dugófej  
 RO Cheie tubulară cu stifturi  
 F Douille  
 I Chiave a bussola spline  
 E Boquilla Spline  
 CN 花键型套筒

1/2" DIN 3121 CrV 50BV30

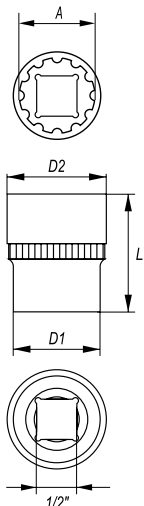
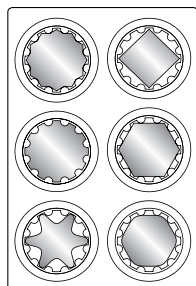

- drive locks
- enables to undo 5 types of screws
- allows to unscrew nuts damaged in 70%
- surface finish: chromed, satin / mirror
- zamki blokujące
- możliwość odkręcenia 5 rodzajów śrub
- możliwość odkręcenia nasadek zniszczonych w 70%
- wykończenie powierzchni: chromowana, satynowa / polerowana

COLOR BOX



| YATO    | ∅ A (mm) | D1 (mm) | D2 (mm) | L (mm) | PCS packing |         |
|---------|----------|---------|---------|--------|-------------|---------|
| YT-1460 | 8        | 13      | 22      | 38     | 10          | 100/200 |
| YT-1461 | 9        | 15      | 22      | 38     | 10          | 100/200 |
| YT-1462 | 10       | 16      | 22      | 38     | 10          | 100/200 |
| YT-1463 | 11       | 17      | 22      | 38     | 10          | 100/200 |
| YT-1464 | 12       | 18      | 22      | 38     | 10          | 100/200 |
| YT-1465 | 13       | 19      | 22      | 38     | 10          | 100/200 |
| YT-1466 | 14       | 20      | 22      | 38     | 10          | 100/200 |
| YT-1467 | 15       | 22      | 23      | 38     | 10          | 100/200 |
| YT-1468 | 16       | 23      | 22      | 38     | 10          | 100/200 |
| YT-1469 | 17       | 25      | 23      | 38     | 10          | 100/200 |
| YT-1470 | 18       | 26      | 23      | 38     | 10          | 100/200 |
| YT-1471 | 19       | 27      | 24      | 38     | 10          | 100/200 |
| YT-1472 | 20       | 28      | 24      | 38     | 10          | 100/200 |
| YT-1473 | 21       | 30      | 24      | 38     | 10          | 100/200 |
| YT-1474 | 22       | 31      | 26      | 38     | 10          | 100/200 |
| YT-1475 | 23       | 32      | 28      | 38     | 10          | 50/100  |
| YT-1476 | 24       | 34      | 28      | 38     | 10          | 50/100  |
| YT-1478 | 27       | 37      | 30      | 42     | 10          | 50/100  |
| YT-1480 | 30       | 41      | 34      | 42     | 10          | 50/100  |
| YT-1481 | 32       | 44      | 36      | 45     | 10          | 50/100  |

- GB Hexagonal deep socket
- D Sechskantenschlüssel, lange
- PL Nasadka sześciokątna długa
- RUS Головка шестигранная длинная
- CZ Šestihranný hluboký nástavec
- H Hatszögű rátét mély
- RO Cheie tubulară hexagonală adâncă
- F Douille longue
- I Chiave a bussola esagonale
- E Boquilla hexagonal larga
- CN 六角长套筒

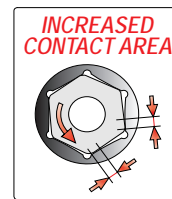
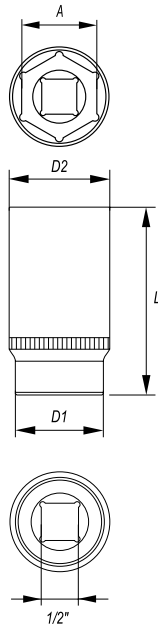

**1/2"**  
**12.5mm**

**DIN 3121**

**CrV**  
**50BV30**

**AS-DRIVE**

- drive locks
- surface finish: chromed, satin / mirror
- zamki blokujące
- wykończenie powierzchni: chromowana, satynowa / polerowana

COLOR BOX



| YATO    | ∅ A (mm) | D1 (mm) | D2 (mm) | L (mm) | PCS packing: |        |
|---------|----------|---------|---------|--------|--------------|--------|
| YT-1221 | 8        | 13      | 22      | 76     | 10           | 50/100 |
| YT-1222 | 9        | 14      | 22      | 76     | 10           | 50/100 |
| YT-1223 | 10       | 15      | 22      | 76     | 10           | 50/100 |
| YT-1224 | 11       | 17      | 22      | 76     | 10           | 50/100 |
| YT-1225 | 12       | 18      | 22      | 76     | 10           | 50/100 |
| YT-1226 | 13       | 19      | 22      | 76     | 10           | 50/100 |
| YT-1227 | 14       | 20      | 22      | 76     | 10           | 50/100 |
| YT-1228 | 15       | 21      | 22      | 76     | 10           | 50/100 |
| YT-1229 | 16       | 24      | 22      | 76     | 10           | 50/100 |
| YT-1230 | 17       | 24      | 22      | 76     | 10           | 50/100 |
| YT-1231 | 18       | 25      | 23      | 76     | 10           | 50/100 |
| YT-1232 | 19       | 27      | 24      | 76     | 10           | 50/100 |
| YT-1233 | 20       | 28      | 24      | 76     | 10           | 50/100 |
| YT-1234 | 21       | 29      | 24      | 76     | 10           | 50/100 |
| YT-1235 | 22       | 30      | 26      | 76     | 10           | 50/100 |
| YT-1236 | 23       | 31      | 28      | 76     | 10           | 50/100 |
| YT-1237 | 24       | 32      | 28      | 76     | 10           | 50/100 |
| YT-1238 | 27       | 36      | 30      | 76     | 10           | 50     |
| YT-1239 | 30       | 40      | 36      | 76     | 10           | 20/40  |
| YT-1240 | 32       | 42      | 38      | 76     | 10           | 20/40  |

- GB Extension bar
- D Verlängerung
- PL Przedłużka
- RUS Удлинитель для воротка
- CZ Prodlužovací přípravek
- H Toldalék
- RO Prelungitor
- F Rallonge
- I Prolunga
- E Tubo de prolongación
- CN 接杆

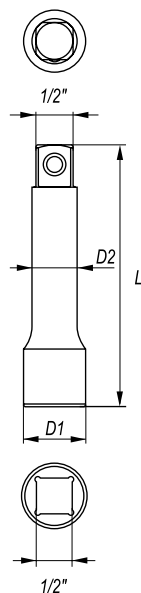

**1/2"**  
**12.5mm**

**DIN 3121**

**CrV**  
**50BV30**

COLOR BOX



| YATO    | ∅              | D1 (mm) | D2 (mm) | L (mm) | PCS packing: |        |
|---------|----------------|---------|---------|--------|--------------|--------|
| YT-1246 | 1/2" (12.7 mm) | 24.0    | 14.5    | 76     | 15           | 30/120 |
| YT-1247 | 1/2" (12.7 mm) | 24.0    | 14.5    | 127    | 5            | 20/80  |
| YT-1248 | 1/2" (12.7 mm) | 24.0    | 14.5    | 254    | 5            | 20/40  |

- GB Extension bar with wobble
- D Gelenverlängerung
- PL Przedłużka uchylna
- RUS Удлинитель наклонный
- CZ Odchylný prodlužovací přípravek
- H Csuklós toldalék
- RO Prelungitor rabatabil
- F Rallonge angulaire
- I Prolunga
- E Tubo de prolongación desviable
- CN 转向接杆

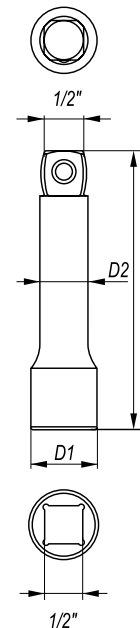

**1/2"**  
**12.5mm**

**DIN 3121**

**CrV**  
**50BV30**

COLOR BOX



| YATO    | ∅              | D1 (mm) | D2 (mm) | L (mm) | PCS packing: |        |
|---------|----------------|---------|---------|--------|--------------|--------|
| YT-1249 | 1/2" (12.7 mm) | 24.0    | 14.5    | 76     | 15           | 30/120 |
| YT-1250 | 1/2" (12.7 mm) | 24.0    | 14.5    | 127    | 5            | 20/80  |
| YT-1251 | 1/2" (12.7 mm) | 24.0    | 14.5    | 254    | 5            | 20/40  |



- GB Adapter  
D Reduktion  
PL Redukcja  
RUS Переходник  
CZ Redukce  
H Redució  
RO Reducție  
F Réduction  
I Riduttore  
E Reducción  
CN 转换头

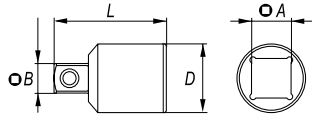

COLOR BOX

|        |      |      |        |
|--------|------|------|--------|
| 1/2"   | 3/4" | DIN  | CrV    |
| 12.5mm | 19mm | 3121 | 50BV30 |

| YATO    | O A                | O B                | D (mm) | L (mm) | PCS packing |         |
|---------|--------------------|--------------------|--------|--------|-------------|---------|
| YT-1255 | 1/2" (12.7 mm) (F) | 3/8" (9.5 mm) (M)  | 22     | 34.0   | 10          | 100/200 |
| YT-1258 | 1/2" (12.7 mm) (F) | 3/4" (19.0 mm) (M) | 27     | 45.5   | 10          | 50/100  |
| YT-1259 | 3/4" (19.0 mm) (F) | 1/2" (12.7 mm) (M) | 35     | 51.0   | 5           | 50/100  |
| YT-1356 | 1/2" (12.7 mm) (F) | 3/4" (19.0 mm) (M) | 26     | 48.0   | 12          | 48      |

- GB Bit adapter  
D Bithalter  
PL Adapter do bitów  
RUS Держатель винтовёртовых наконечников  
CZ Držák na šroubovakové koncovky  
H Szár a csavarhúzóvégekhez  
RO Capete şurubelniță  
F Adapteur d'embouts  
I Chiave esagonale a bussola  
E Mandril para puntas  
CN 旋具头接头

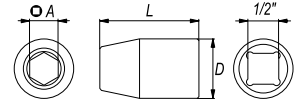

COLOR BOX

|        |      |
|--------|------|
| 1/2"   | CrV  |
| 12.5mm | 6140 |

| YATO    | O              | O A  | D (mm) | L (mm) | PCS packing |         |
|---------|----------------|------|--------|--------|-------------|---------|
| YT-1295 | 1/2" (12.7 mm) | 8 mm | 21.9   | 38     | 10          | 250/500 |

- GB Universal joint  
D Kardangelenk  
PL Przegub Cardana  
RUS Карданный шарнир  
CZ Kardanový kloub  
H Kardán csukló

- RO Articulație Cardanică  
F Cardan  
I Snodo cardanico  
E Articulación Cardan  
CN 万向接头

|        |      |        |
|--------|------|--------|
| 1/2"   | DIN  | CrV    |
| 12.5mm | 3121 | 50BV30 |

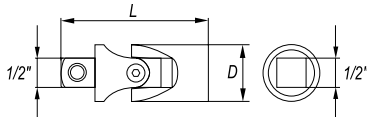

COLOR BOX

| YATO    | O              | D (mm) | L (mm) | PCS packing |        |
|---------|----------------|--------|--------|-------------|--------|
| YT-1252 | 1/2" (12.7 mm) | 25     | 69     | 5           | 50/100 |

- GB Sliding T-bar  
D Handgriff  
PL Pokrętko typu „T”  
RUS Вороток Т-образный

- CZ Otočná ráčka typ „T”  
H „T” alakú hajtókar  
RO Mâner clupă tipul „T”  
F Barre type „T”  
I Manopola „T” scorrevole  
E Mango tipo „T”  
CN 滑行杆

|        |      |        |
|--------|------|--------|
| 1/2"   | DIN  | CrV    |
| 12.5mm | 3121 | 50BV30 |

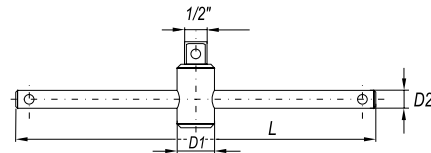

COLOR BOX

| YATO    | O              | D1 (mm) | D2 (mm) | L (mm) | PCS packing |       |
|---------|----------------|---------|---------|--------|-------------|-------|
| YT-1243 | 1/2" (12.7 mm) | 24.0    | 13.5    | 255    | 4           | 24/48 |

- GB Flexible handle  
D Gelengriff  
PL Pokrętko łamane  
RUS Вороток шарнирный  
CZ Otočná lomená ráčka  
H Hajlított hajtókar  
RO Prelungitor cu prindere flexibilă  
F Barre pivotante  
I Manopola a snodo  
E Mango articulado  
CN 转向手柄

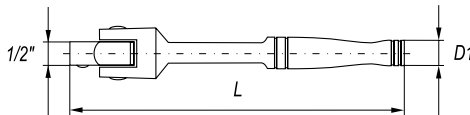

|        |      |        |
|--------|------|--------|
| 1/2"   | DIN  | CrV    |
| 12.5mm | 3121 | 50BV30 |

COLOR BOX

| YATO    | O              | D (mm) | L (mm) | PCS packing |       |
|---------|----------------|--------|--------|-------------|-------|
| YT-1241 | 1/2" (12.7 mm) | 19     | 360    | 5           | 15/30 |
| YT-1242 | 1/2" (12.7 mm) | 20     | 457    | 5           | 10/20 |

- GB L-type handle  
D Admutternschlüssel  
PL Pokrętko typu „L”  
RUS Вороток 1/2" тип „L”  
CZ Páka zahnutá  
H „L” alakú hajtókar  
RO Mâner clupă tipul „L”  
F Barre type „L”  
I Leva tipo „L”  
E Mango tipo „L”  
CN L型套筒扳手



|        |      |        |
|--------|------|--------|
| 1/2"   | DIN  | CrV    |
| 12.5mm | 3121 | 50BV30 |

COLOR BOX

| YATO    | O              | D (mm) | L (mm) | PCS packing |    |
|---------|----------------|--------|--------|-------------|----|
| YT-1244 | 1/2" (12.7 mm) | 16.5   | 317    | 3           | 36 |

- GB Spark plug socket  
D Steckschlüssel mit Gummihalterung  
PL Nasadka do świec  
RUS Головка свечная  
CZ Nastavec pro svíčky  
H Gyújtógyertya toldalék  
RO Cheie de bujii  
F Douille à bougies  
I Chiavi a bussola  
E Boquilla de bujías  
CN 六角火花塞套筒

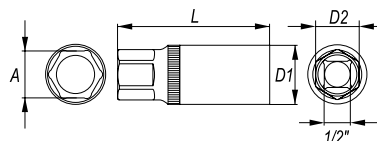

|        |      |        |          |
|--------|------|--------|----------|
| 1/2"   | DIN  | CrV    | AS-DRIVE |
| 12.5mm | 3121 | 50BV30 |          |

COLOR BOX

| YATO    | O              | A    | D1 (mm) | D2 (mm) | L (mm) | PCS packing |        |
|---------|----------------|------|---------|---------|--------|-------------|--------|
| YT-1253 | 1/2" (12.7 mm) | 16.0 | 22.0    | 19.0    | 64.0   | 10          | 50/100 |
| YT-1254 | 1/2" (12.7 mm) | 21.0 | 27.8    | 24.0    | 64.0   | 10          | 50/100 |

GB Quick release ratchet handle  
 D Hebelumschaltknarre  
 PL Grzechotka  
 RUS Трещотка  
 CZ Řehtačka  
 H Racsnis hajtókar

RO Dispozitiv de prindere cu clichet  
 F Clé à cliquet  
 I Cricchetto bussola  
 E Carraca  
 CN 快速脱落棘轮扳手

PLASTIC HANGER



6 PCS



COLOR BOX

1/2"  
12.5mm

DIN  
3122

QUICK  
RELEASE  
SZYBKO-  
ZŁĄCZE

72T

CrV  
6140



| YATO    | Ø              | T  | L (mm) | PCS packing: | ☐  |
|---------|----------------|----|--------|--------------|----|
| YT-0309 | 1/2" (12.7 mm) | 72 | 278    | 6            | 24 |

| YATO    | Ø              | T  | L (mm) | PCS packing: | ☐     |
|---------|----------------|----|--------|--------------|-------|
| YT-0312 | 1/2" (12.7 mm) | 72 | 250    | 6            | 12/24 |

| YATO    | Ø              | T  | L (mm) | PCS packing: | ☐  |
|---------|----------------|----|--------|--------------|----|
| YT-0315 | 1/2" (12.7 mm) | 72 | 250    | 6            | 24 |



| YATO    | Ø              | T  | L (mm) | PCS packing: | ☐  |
|---------|----------------|----|--------|--------------|----|
| YT-0318 | 1/2" (12.7 mm) | 72 | 250    | 6            | 24 |

| YATO    | Ø              | T  | L (mm) | PCS packing: | ☐  |
|---------|----------------|----|--------|--------------|----|
| YT-0321 | 1/2" (12.7 mm) | 72 | 255    | 6            | 24 |

| YATO    | Ø              | T  | L (mm) | PCS packing: | ☐  |
|---------|----------------|----|--------|--------------|----|
| YT-0324 | 1/2" (12.7 mm) | 72 | 265    | 6            | 24 |

GB Quick release ratchet handle  
 D Hebelumschaltknarre  
 PL Grzechotka  
 RUS Трещотка  
 CZ Řehtačka  
 H Racsnis hajtókar

RO Dispozitiv de prindere cu clichet  
 F Clé à cliquet  
 I Cricchetto bussola  
 E Carraca  
 CN 快速脱落棘轮扳手

PLASTIC HANGER



6 PCS



COLOR BOX

1/2"  
12.5mm

QUICK  
RELEASE  
SZYBKO-  
ZŁĄCZE

DIN  
3122

72T

CrV  
6140

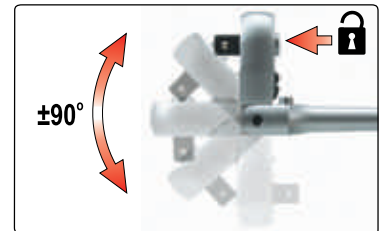

| YATO    | Ø              | T  | L (mm) | PCS packing: | ☐  |
|---------|----------------|----|--------|--------------|----|
| YT-0327 | 1/2" (12.7 mm) | 72 | 290    | 6            | 24 |

GB Quick release ratchet handle  
 D Hebelumschaltknarre  
 PL Grzechotka powlekana  
 RUS Трещотка  
 CZ Řehtačka  
 H Racsnis hajtókar

RO Dispozitiv de prindere cu clichet  
 F Clé à cliquet  
 I Cricchetto bussola  
 E Carraca  
 CN 快速脱落棘轮扳手

PLASTIC HANGER



6 PCS



COLOR BOX

1/2"  
12.5mm

QUICK  
RELEASE  
SZYBKO-  
ZŁĄCZE

DIN  
3122

72T

CrV  
6135



| YATO    | Ø              | T  | L (mm) | PCS packing: | ☐  |
|---------|----------------|----|--------|--------------|----|
| YT-0292 | 1/2" (12.7 mm) | 72 | 257    | 6            | 24 |

| YATO    | Ø              | T  | L (mm) | PCS packing: | ☐  |
|---------|----------------|----|--------|--------------|----|
| YT-0295 | 1/2" (12.7 mm) | 72 | 257    | 6            | 24 |



- GB Quick release ratchet handle  
 D Hebelumschaltknarre  
 PL Grzechotka  
 RUS Трещотка  
 CZ Řehtačka  
 H Racsnis hajtókar  
 RO Dispozitiv de prindere cu clichet  
 F Clé à cliquet  
 I Cricchetto bussola  
 E Carraca  
 CN 快速脱落棘轮扳手

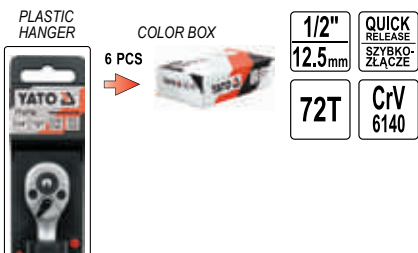

1/2"  
 12.5mm  
 72T  
 CrV  
 6140



| YATO    | Ø              | T  | L (mm) | PCS packing: |    |
|---------|----------------|----|--------|--------------|----|
| YT-0732 | 1/2" (12.7 mm) | 72 | 255    | 6            | 24 |

- GB Quick release ratchet handle  
 D Hebelumschaltknarre  
 PL Grzechotka  
 RUS Трещотка  
 CZ Řehtačka  
 H Racsnis hajtókar  
 RO Dispozitiv de prindere cu clichet  
 F Clé à cliquet  
 I Cricchetto bussola  
 E Carraca  
 CN 快速脱落棘轮扳手

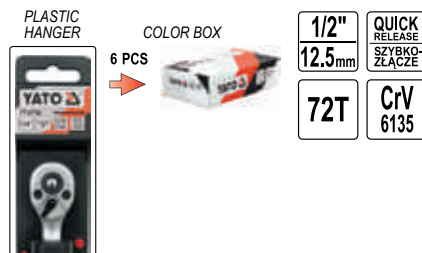

1/2"  
 12.5mm  
 72T  
 CrV  
 6135



| YATO    | Ø              | T  | L (mm) | PCS packing: |    |
|---------|----------------|----|--------|--------------|----|
| YT-0735 | 1/2" (12.7 mm) | 72 | 255    | 6            | 24 |

- GB Telescopic ratchet handle  
 D Umschaltknarre  
 PL Grzechotka z przedłużanym uchwytem  
 RUS Трещотка  
 CZ Řehtačka  
 H Racsnis hajtókar  
 RO Antrenor cu clichet  
 F Clé à cliquet  
 I Cricchetto bussola  
 E Carraca telescópico  
 CN 可伸缩快速脱落棘轮扳手



1/2"  
 12.5mm  
 72T  
 CrV  
 6135

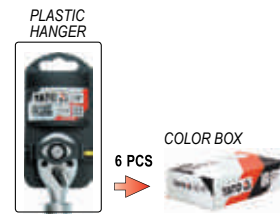

| YATO    | Ø              | T  | L (mm)  | PCS packing: |    |
|---------|----------------|----|---------|--------------|----|
| YT-0299 | 1/2" (12.7 mm) | 72 | 305-445 | 6            | 24 |

- GB Flexible ratchet handle / round head  
 D Flexible Drehkopfratsche  
 PL Grzechotka z obrotową głowicą  
 RUS Трещотка с вращательной головкой  
 CZ Ráčna s otočnou hlavou  
 H Forgófejés racsnis szár  
 RO Antrenor cu clichet flexibil  
 F Clé à cliquet tête pivotante  
 I Cricchetto bussola reversibile con ghiera  
 E Carraca con cabeza giratoria  
 CN 旋转头快速脱落棘轮扳手



1/2"  
 12.5mm  
 72T  
 CrV  
 6140

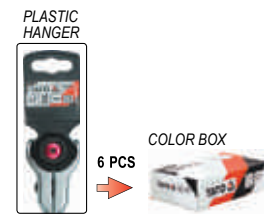

| YATO    | Ø              | T  | L (mm) | PCS packing: |    |
|---------|----------------|----|--------|--------------|----|
| YT-0722 | 1/2" (12.7 mm) | 72 | 280    | 6            | 30 |

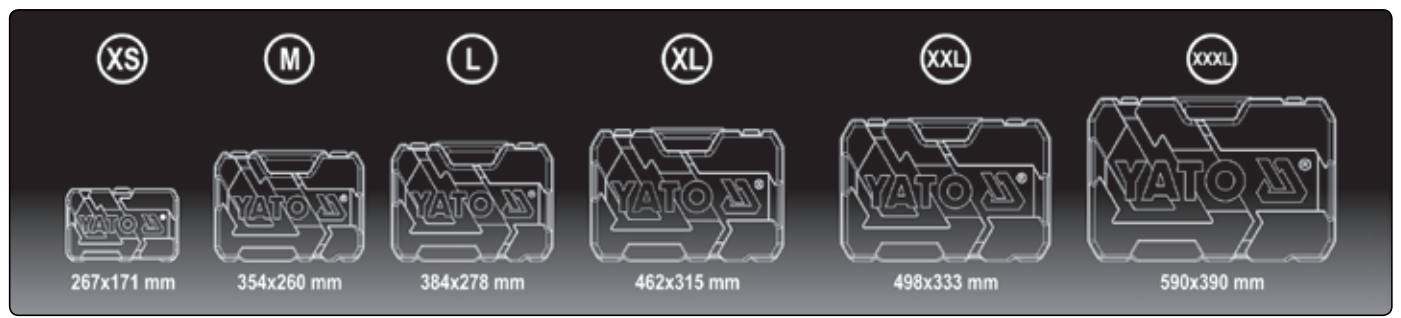

GB Tool set  
 D Sechskant-Steckschlüssel-Satz  
 PL Zestaw narzędziowy  
 RUS Набор инструмента  
 CZ Sada nástrčných kľúčů a ráčny  
 H Dugókulcs készlet racsnis hajtókarral

RO Rotrusa chei tubulare cu antrenor  
 F Coffret d'outillage  
 I Set di utensili  
 E Juego de herramientas  
 CN 套筒扳手组套

BMC & COLOR SLEEVE  
 XS SIZE



|       |          |      |
|-------|----------|------|
| 1/4"  | CrV      | CrMo |
| 6.3mm | 50BV30   | 440  |
| 72T   | AS-DRIVE |      |



23  
 PCS

- 1/4" (6.3 mm): 4, 5, 6, 7, 8, 9, 10, 12, 13 mm (L=25 mm); CrV 50BV30;
- 1/4" (6.3 mm): 4, 5, 6, 7, 8, 9, 10, 12, 13 mm (L=50 mm); CrV 50BV30;
- 1/4" (6.3 mm): (50.8, 152.4 mm); CrV 50BV30;
- 1/4" (6.3 mm); CrV 50BV30;
- 1/4" (6.3 mm): (155 mm); 72T; CrMo 440;
- 1/4" (6.3 mm): (150 mm); CrV 50BV30

|             |               |    |
|-------------|---------------|----|
| <b>YATO</b> | ○             |    |
| YT-14451    | 1/4" (6.3 mm) | 10 |



25  
 PCS

CrV  
 40

- 1/4" (6.3 mm): 3.5, 4, 4.5, 5, 5.5, 6, 7, 8, 9, 10, 11, 12, 13, 14 mm (L=25 mm); CrV 50BV30;
- 1/4" (6.3 mm): 8, 10, 11, 12, 13 mm (L=50 mm); CrV 50BV30;
- 1/4" (6.3 mm): (50.8, 101.6 mm); CrV 50BV30;
- 1/4" (6.3 mm); CrV 50BV30;
- 1/4" (6.3 mm): (152.4 mm); CrV 40;
- 1/4" (6.3 mm): (155 mm); 72T; CrMo 440;
- 1/4" (6.3 mm): (150 mm); CrV 50BV30

|             |               |    |
|-------------|---------------|----|
| <b>YATO</b> | ○             |    |
| YT-14461    | 1/4" (6.3 mm) | 10 |



38  
 PCS

CrV  
 6150

CrV  
 40

S2

- 1/4" (6.3 mm): 3.5, 4, 4.5, 5, 5.5, 6, 7, 8, 9, 10, 11, 12, 13, 14 mm (L=25 mm); CrV 50BV30;
- 1/4" (6.3 mm): (50.8, 101.6 mm); CrV 50BV30;
- 1/4" (6.3 mm); CrV 50BV30;
- 1/4" (6.3 mm): (152.4 mm); CrV 40;
- 1/4" (6.3 mm): (155 mm); 72T; CrMo 440;
- 1/4" (6.3 mm); CrV 50BV30;
- 1/4" (6.3 mm): 4, 5.5, 6.5 mm (L=37 mm); AISI S2 / CrV 6150;
- 1/4" (6.3 mm): PH1, PH2 (L=37 mm); AISI S2 / CrV 6150;
- 1/4" (6.3 mm): PZ1, PZ2 (L=37 mm); AISI S2 / CrV 6150;
- 1/4" (6.3 mm): T10, T15, T20, T25, T30, T40 (L=37 mm); AISI S2 / CrV 6150;
- 1/4" (6.3 mm): 3, 4, 5, 6, 8 mm (L=37 mm); AISI S2 / CrV 6150

|             |               |    |
|-------------|---------------|----|
| <b>YATO</b> | ○             |    |
| YT-14471    | 1/4" (6.3 mm) | 10 |



GB Tool set  
D Sechskant-Steckschlüssel-Satz  
PL Zestaw narzędziowy  
RUS Набор инструмента

CZ Sada nástrčných klíčů a ráčny  
H Dugókulcs készlet racsnis hajtókarral  
RO Rotruşa chei tubulare cu antrenor  
F Coffret d'outillage

I Set di utensili  
E Juego de herramientas  
CN 套筒扳手组套

BMC & COLOR SLEEVE  
XS SIZE



|               |               |             |
|---------------|---------------|-------------|
| 1/4"<br>6.3mm | CrV<br>50BV30 | CrV<br>6150 |
| CrV<br>40     | CrMo<br>440   | S2          |
| 72T           | AS-DRIVE      |             |

42  
PCS



- 1/4" (6.3 mm): 4, 4.5, 5, 5.5, 6, 7, 8, 9, 10, 11, 12, 13, 14 mm (L=25 mm); CrV 50BV30;
- 1/4" (6.3 mm): 8, 9, 10, 11, 12, 13 mm (L=50 mm); CrV 50BV30;
- 1/4" (6.3 mm): (50.8, 101.6 mm); CrV 50BV30;
- 1/4" (6.3 mm): (150 mm); CrV 50BV30;
- 1/4" (6.3 mm): CrV 50BV30;
- 1/4" (6.3 mm): (152.4 mm); CrV 40;
- 1/4" (6.3 mm): (155 mm); 72T; CrMo 440;
- 1/4" (6.3 mm): (150 mm); CrV 50BV30;
- 1/4" (6.3 mm) x 1/4" (6.3 mm): CrV 50BV30;
- 1/4" (6.3 mm): 3, 4, 5 mm (L=25 mm); AISI S2;
- 1/4" (6.3 mm): PH0, PH1, PH2 (L=25 mm); AISI S2;
- 1/4" (6.3 mm): PZ0, PZ1, PZ2 (L=25 mm); AISI S2;
- 1/4" (6.3 mm): 6, 7, 8 mm (L=25 mm); AISI S2;
- 1.5, 2.0, 2.5 mm; CrV 6150

|             |               |   |
|-------------|---------------|---|
| <b>YATO</b> | ○             |   |
| YT-14481    | 1/4" (6.3 mm) | 6 |



56  
PCS

- 1/4" (6.3 mm): 4, 4.5, 5, 5.5, 6, 7, 8, 9, 10, 11, 12, 13 mm (L=25 mm); CrV 50BV30;
- 1/4" (6.3 mm): 6, 7, 8, 9, 10, 11, 12, 13 mm (L=50 mm); CrV 50BV30;
- 1/4" (6.3 mm): E4, E5, E6, E7, E8, E10; CrV 6150;
- 1/4" (6.3 mm): (76, 152.4 mm); CrV 50BV30;
- 1/4" (6.3 mm): (150 mm); CrV 50BV30;
- 1/4" (6.3 mm): CrV 50BV30;
- 1/4" (6.3 mm): (152.4 mm); CrV 40;
- 1/4" (6.3 mm): (155 mm); 72T; CrMo 440;
- 1/4" (6.3 mm): (150 mm); CrV 50BV30;
- 1/4" (6.3 mm) (F) x 3/8" (9.5 mm) (M); CrV 50BV30;
- 1/4" (6.3 mm): 4, 5, 5.5 mm (L=37 mm); AISI S2 / CrV 6150;
- 1/4" (6.3 mm): PH1, PH2, PH3 (L=37 mm); AISI S2 / CrV 6150;
- 1/4" (6.3 mm): PZ1, PZ2, PZ3 (L=37 mm); AISI S2 / CrV 6150;
- 1/4" (6.3 mm): T8, T10, T15, T20, T25, T30, T40 (L=37 mm); AISI S2 / CrV 6150;
- 1/4" (6.3 mm): 3, 4, 5, 6, 7, 8 mm (L=37 mm); AISI S2 / CrV 6150

|             |               |    |
|-------------|---------------|----|
| <b>YATO</b> | ○             |    |
| YT-14501    | 1/4" (6.3 mm) | 10 |

GB Tool set  
D Sechskant-Steckschlüssel-Satz  
PL Zestaw narzędziowy  
RUS Набор инструмента

CZ Sada nástrčných klíčů a ráčny  
H Dugókulcs készlet racsnis hajtókarral  
RO Rotruşa chei tubulare cu antrenor  
F Coffret d'outillage

I Set di utensili  
E Juego de herramientas  
CN 套筒扳手组套

BMC & COLOR SLEEVE  
XS SIZE



|             |              |               |           |
|-------------|--------------|---------------|-----------|
| 22<br>PCS   | 3/8"<br>10mm | CrV<br>50BV30 | CrV<br>40 |
| CrMo<br>440 | 72T          | AS-DRIVE      |           |



- 3/8" (9.5 mm): 6, 7, 8, 9, 10, 11, 12, 13, 14, 15, 16 mm (L=28 mm); 17, 18, 19, 20, 21, 22 mm (L=30 mm); CrV 50BV30;
- 3/8" (9.5 mm): (76, 152.4 mm); CrV 50BV30;
- 3/8" (9.5 mm); CrV 50BV30;
- 3/8" (9.5 mm): (198 mm); CrV 40;
- 3/8" (9.5 mm): (200 mm); 72T; CrMo 440

|             |               |    |
|-------------|---------------|----|
| <b>YATO</b> | ○             |    |
| YT-38561    | 3/8" (9.5 mm) | 10 |



GB Socket set  
D Sechskant-Steckschlüssel-Satz  
PL Komplet nasadek długich  
RUS Набор насадок

CZ Sada nástrčných klíčů  
H Dugókulcs készlet  
RO Trusă chei tubulare  
F Set de douilles longues

I Serie di chiavi a bussola lunghi  
E Juego de herramientas  
CN 长套筒组套

PLASTIC HANGER



10  
PCS

1/2"  
12.5mm

CrV  
50BV30

AS-DRIVE



1/2" (12.7 mm): 10, 12, 13, 14, 15, 17, 19, 21, 22, 24 mm (L=76 mm); CrV 50BV30

|             |                |      |
|-------------|----------------|------|
| <b>YATO</b> | ○              |      |
| YT-38861    | 1/2" (12.7 mm) | 5/10 |

GB Socket set  
D Sechskantenschlüssel-Einsatz  
PL Komplet nasadek z akcesoriami  
RUS Набор торцевых головок

CZ Sada nástrčných klíčů a ráčny  
H Dugókulcs készlet racsnis hajtókkal  
RO Trusă chei tubulare cu antrenor  
F Set de douilles + accessoires

I Serie di chiavi a con accessori  
E Juego de boquillas con accesorios  
CN 套筒扳手组套

PLASTIC HANGER



12  
PCS

1/2"  
12.5mm

CrV  
50BV30

CrMo  
440

72T

AS-DRIVE



1/2" (12.7 mm): 10, 11, 12, 13, 14, 15, 17, 19, 21, 24 mm (L=38 mm); CrV 50BV30;  
1/2" (12.7 mm): (127 mm); CrV 50BV30;  
1/2" (12.7 mm): (255 mm); 72T; CrMo 440

|             |                |      |
|-------------|----------------|------|
| <b>YATO</b> | ○              |      |
| YT-38821    | 1/2" (12.7 mm) | 5/10 |

GB Ratchet handle with socket set  
D Sechskant-Steckschlüssel-Satz  
PL Komplet nasadek z grzechotką  
RUS Набор насадок

CZ Sada nástrčných klíčů a ráčny  
H Dugókulcs készlet racsnis hajtókkal  
RO Rotrusă chei tubulare cu antrenor  
F Clé mixte à cliquet + douilles

I Serie di chiavi con cricchetto  
E Matraca con boquillas  
CN 套筒扳手组套

PLASTIC HANGER



19  
PCS

1/2"  
12.5mm

CrV  
50BV30

CrMo  
440

72T

AS-DRIVE



1/2" (12.7 mm): 8, 9, 10, 11, 12, 13, 14, 15, 16, 17, 19, 21, 22, 23, 24 mm (L=38 mm);  
27, 30, 32 mm (L=42 mm); CrV 50BV30;  
1/2" (12.7 mm): (255 mm); 72T; CrMo 440

|             |                |     |
|-------------|----------------|-----|
| <b>YATO</b> | ○              |     |
| YT-38681    | 1/2" (12.7 mm) | 3/6 |



GB Tool set  
 D Sechskant-Steckschlüssel-Satz  
 PL Zestaw narzędziowy  
 RUS Набор инструмента

CZ Sada nástrčných klíčů a ráčny  
 H Dugókulcs készlet racsnis hajtókarral  
 RO Rotrușa chei tubulare cu antrenor  
 F Coffret d'outillage

I Set di utensili  
 E Juego de herramientas  
 CN 套筒扳手組套



BMC & COLOR SLEEVE  
 XS SIZE



|           |                |               |             |
|-----------|----------------|---------------|-------------|
| 12<br>PCS | 1/2"<br>12.5mm | CrV<br>50BV30 | CrMo<br>440 |
|           |                | 72T           | AS-DRIVE    |



1/2" (12.7 mm): 10, 11, 12, 13, 14, 15, 17, 19, 21, 24 mm  
 (L=38 mm); CrV 50BV30;  
 1/2" (12.7 mm): (127 mm); CrV 50BV30;  
 1/2" (12.7 mm): (255 mm); 72T; CrMo 440

|   |   |   |
|---|---|---|
| <b>YATO</b>  |  |  |
| YT-38671  | 1/2" (12.7 mm)  | 10  |

GB Tool set  
 D Sechskant-Steckschlüssel-Satz  
 PL Zestaw narzędziowy  
 RUS Набор инструмента

CZ Sada nástrčných klíčů a ráčny  
 H Dugókulcs készlet racsnis hajtókarral  
 RO Rotrușa chei tubulare cu antrenor  
 F Coffret d'outillage

I Set di utensili  
 E Juego de herramientas  
 CN 套筒扳手組套



BMC & COLOR SLEEVE  
 L SIZE



|           |                |               |
|-----------|----------------|---------------|
| 77<br>PCS | 1/2"<br>12.5mm | 1/4"<br>6.3mm |
|           | CrV<br>50BV30  | CrV<br>6150   |
|           | CrMo<br>440    | S2            |
|           | 72T            | AS-DRIVE      |



1/2" (12.7 mm): 10, 11, 12, 13, 14, 15, 17, 19, 22, 24 mm (L=38 mm);  
 27, 30, 32 mm (L=42 mm),  
 1/4" (6.3 mm): 4, 5, 6, 7, 8, 9, 10, 11, 12 mm (L=25 mm); CrV 50BV30;  
 1/2" (12.7 mm): (127, 254 mm),  
 1/4" (6.3 mm): (76, 101.6 mm); CrV 50BV30;  
 1/2" (12.7 mm), 1/4" (6.3 mm): CrV 50BV30;  
 1/2" (12.7 mm): 16, 21 mm; CrV 50BV30;  
 1/2" (12.7 mm): (255 mm),  
 1/4" (6.3 mm): (155 mm); 72T; CrMo 440;  
 1/4" (6.3 mm) x 1/4" (6.3 mm): CrV 50BV30;  
 1/4" (6.3 mm) x 1/4" (6.3 mm): CrV 50BV30;  
 1/4" (6.3 mm): 3, 4, 5.5, 7 mm (L=25 mm); AISI S2;  
 1/4" (6.3 mm): PH0, PH1, PH2, PH3 (L=25 mm); AISI S2;  
 1/4" (6.3 mm): PZ1, PZ2, PZ3 (L=25 mm); AISI S2;  
 1/4" (6.3 mm): T10, T15, T20, T25, T30 (L=25 mm); AISI S2;  
 1/4" (6.3 mm): 2, 3, 4, 5, 6 mm (L=25 mm); AISI S2;  
 7, 8, 9, 10, 11, 12, 13, 14, 15, 17, 19 mm; CrV;  
 8x9, 10x11, 12x13, 14x15 mm; CrV 50BV30;  
 1.5, 2, 2.5, 5, 6, 8, 10 mm; CrV 6150

|   |   |   |   |
|---|---|---|---|
| <b>YATO</b>  |  |  |  |
| YT-38781  | 1/2" (12.7 mm)  | 1/4" (6.3 mm)   | 2   |



GB Tool set  
 D Sechskant-Steckschlüssel-Satz  
 PL Zestaw narzędziowy  
 RUS Набор инструмента

CZ Sada nástrčných klíčů a ráčny  
 H Dugókulcs készlet racsnis hajtókarral  
 RO Rotrusa chei tubulare cu antrenor  
 F Coffret d'outillage

I Set di utensili  
 E Juego de herramientas  
 CN 套筒扳手组套

BMC & COLOR SLEEVE  
 L SIZE



|               |             |
|---------------|-------------|
| 1/2"          | 1/4"        |
| 12.5mm        | 6.3mm       |
| CrV<br>50BV30 | CrV<br>6150 |
| CrV<br>40     | CrMo<br>440 |
| S2            | 72T         |
| AS-DRIVE      |             |

2



**82**  
PCS

1/2" (12.7 mm): 14, 15, 16, 17, 18, 19, 20, 22, 24 mm (L=38 mm); 27, 30, 32 mm (L=42 mm), 1/4" (6.3 mm): 4, 4.5, 5, 5.5, 6, 7, 8, 9, 10, 11, 12, 13, 14 mm (L=25 mm); CrV 50BV30: 1/2" (12.7 mm): (127, 254 mm), 1/4" (6.3 mm): (50.8, 101.6 mm); CrV 50BV30: 3/8" (9.5 mm) (F) x 1/2" (12.7 mm) (M); CrV 50BV30: 1/4" (6.3 mm): (150 mm); CrV 50BV30: 1/2" (12.7 mm), 1/4" (6.3 mm); CrV 50BV30: 1/2" (12.7 mm): 16, 21 mm; CrV 50BV30: 1/4" (6.3 mm): (152.4 mm); CrV 40: 1/2" (12.7 mm): (255 mm), 1/4" (6.3 mm): (155 mm); 72T; CrMo 440: 1/4" (6.3 mm): (150 mm); CrV 50BV30: 1/2" (12.7 mm) x 5/16" (7.9 mm); CrV 50BV30: 1/4" (6.3 mm) x 1/4" (6.3 mm); CrV 50BV30: 5/16" (7.9 mm): 8, 10, 12 mm (L=30 mm); AISI S2: 5/16" (7.9 mm): PH3, PH4 (L=30 mm); AISI S2: 5/16" (7.9 mm): PZ3, PZ4 (L=30 mm); AISI S2: 5/16" (7.9 mm): T40, T45, T50, T55 (L=30 mm); AISI S2: 5/16" (7.9 mm): 8, 10, 12, 14 mm (L=30 mm); AISI S2: 1/4" (6.3 mm): 4, 5, 5, 7 mm (L=37 mm); AISI S2 / CrV 6150: 1/4" (6.3 mm): PH1, PH2 (L=37 mm); AISI S2 / CrV 6150: 1/4" (6.3 mm): PZ1, PZ2 (L=37 mm); AISI S2 / CrV 6150: 1/4" (6.3 mm): T8, T10, T15, T20, T25, T30 (L=37 mm); AISI S2 / CrV 6150: 1/4" (6.3 mm): 3, 4, 5, 6 mm (L=37 mm); AISI S2 / CrV 6150: 8, 10, 11, 12, 13, 14, 17, 19, 22 mm; CrV

| YATO     | 1/2" (12.7 mm) | 1/4" (6.3 mm) | 4 |
|----------|----------------|---------------|---|
| YT-12691 | 1/2" (12.7 mm) | 1/4" (6.3 mm) | 4 |



**94**  
PCS

1/2" (12.7 mm): 10, 11, 12, 13, 14, 15, 16, 17, 18, 19, 20, 21, 22, 23, 24 mm (L=38 mm); 27, 30, 32 mm (L=42 mm), 1/4" (6.3 mm): 4, 4.5, 5, 5.5, 6, 7, 8, 9, 10, 11, 12, 13, 14 mm (L=25 mm); CrV 50BV30: 1/2" (12.7 mm): 14, 15, 17, 19 mm (L=76 mm), 1/4" (6.3 mm): 6, 7, 8, 9, 10, 11, 12, 13 mm (L=50 mm); CrV 50BV30: 1/2" (12.7 mm): (127, 254 mm), 1/4" (6.3 mm): (50.8, 101.6 mm); CrV 50BV30: 3/8" (9.5 mm) (F) x 1/2" (12.7 mm) (M); CrV 50BV30: 1/4" (6.3 mm): (150 mm); CrV 50BV30: 1/2" (12.7 mm), 1/4" (6.3 mm); CrV 50BV30: 1/2" (12.7 mm): 16, 21 mm; CrV 50BV30: 1/4" (6.3 mm): (152.4 mm); CrV 40: 1/2" (12.7 mm): (255 mm), 1/4" (6.3 mm): (155 mm); 72T; CrMo 440: 1/4" (6.3 mm): (150 mm); CrV 50BV30: 1/2" (12.7 mm) x 5/16" (7.9 mm); CrV 50BV30: 1/4" (6.3 mm) x 1/4" (6.3 mm); CrV 50BV30: 5/16" (7.9 mm): 8, 10, 12 mm (L=30 mm); AISI S2: 5/16" (7.9 mm): PH3, PH4 (L=30 mm); AISI S2: 5/16" (7.9 mm): PZ3, PZ4 (L=30 mm); AISI S2: 5/16" (7.9 mm): T40, T45, T50, T55 (L=30 mm); AISI S2: 5/16" (7.9 mm): 8, 10, 12, 14 mm (L=30 mm); AISI S2: 1/4" (6.3 mm): 4, 5, 5, 7 mm (L=37 mm); AISI S2 / CrV 6150: 1/4" (6.3 mm): PH1, PH2 (L=37 mm); AISI S2 / CrV 6150: 1/4" (6.3 mm): PZ1, PZ2 (L=37 mm); AISI S2 / CrV 6150: 1/4" (6.3 mm): T8, T10, T15, T20, T25, T30 (L=37 mm); AISI S2 / CrV 6150: 1/4" (6.3 mm): 3, 4, 5, 6 mm (L=37 mm); AISI S2 / CrV 6150: 1.5, 2, 2.5 mm; CrV 6150

| YATO     | 1/2" (12.7 mm) | 1/4" (6.3 mm) | 4 |
|----------|----------------|---------------|---|
| YT-12681 | 1/2" (12.7 mm) | 1/4" (6.3 mm) | 4 |



GB Tool set  
D Sechskant-Steckschlüssel-Satz  
PL Zestaw narzędziowy  
RUS Набор инструмента

CZ Sada nástrčných klíčů a ráčny  
H Dugókulcs készlet racsnis hajtókarral  
RO Rotirusa chei tubulare cu antrenor  
F Coffret d'outillage

I Set di utensili  
E Juego de herramientas  
CN 套筒扳手组套

|                |               |
|----------------|---------------|
| 1/2"<br>12.5mm | 1/4"<br>6.3mm |
| CrV<br>50BV30  | CrV<br>6150   |
| CrMo<br>440    | S2            |
| 72T            | AS-DRIVE      |



108  
PCS

CrV  
40

BMC & COLOR SLEEVE  
L SIZE



1/2" (12.7 mm): 10, 11, 12, 13, 14, 15, 16, 17, 18, 19, 20, 21, 22, 24 mm (L=38 mm); 27, 30, 32 mm (L=42 mm); 1/4" (6.3 mm): 4, 4.5, 5, 5.5, 6, 7, 8, 9, 10, 11, 12, 13, 14 mm (L=25 mm); CrV 50BV30: 1/2" (12.7 mm): 14, 15, 17, 19, 22 mm (L=76 mm); 1/4" (6.3 mm): 6, 7, 8, 9, 10, 11, 12, 13 mm (L=50 mm); CrV 50BV30: 1/2" (12.7 mm): E10, E11, E12, E14, E16, E18, E20, E24; 1/4" (6.3 mm): E4, E5, E6, E7, E8; CrV 6150: 1/2" (12.7 mm): (127, 254 mm); 1/4" (6.3 mm): (50.8, 101.6 mm); CrV 50BV30: 3/8" (9.5 mm) (F) x 1/2" (12.7 mm) (M); CrV 50BV30: 1/2" (12.7 mm); 1/4" (6.3 mm); CrV 50BV30: 1/2" (12.7 mm): 16, 21 mm; CrV 50BV30: 1/4" (6.3 mm); (152.4 mm); CrV 40: 1/2" (12.7 mm); (255 mm); 1/4" (6.3 mm); (155 mm); 72T; CrMo 440: 1/4" (6.3 mm); (150 mm); CrV 50BV30: 1/2" (12.7 mm) x 5/16" (7.9 mm); CrV 50BV30: 5/16" (7.9 mm): 8, 10, 12 mm (L=30 mm); AISI S2: 5/16" (7.9 mm): PH3, PH4 (L=30 mm); AISI S2: 5/16" (7.9 mm): PZ3, PZ4 (L=30 mm); AISI S2: 5/16" (7.9 mm): T40, T45, T50, T55, T60 (L=30 mm); AISI S2: 5/16" (7.9 mm): 7, 8, 10, 12, 14 mm (L=30 mm); AISI S2: 1/4" (6.3 mm): 4, 5, 6, 5 mm (L=37 mm); AISI S2 / CrV 6150: 1/4" (6.3 mm): PH1, PH2 (L=37 mm); AISI S2 / CrV 6150: 1/4" (6.3 mm): PZ1, PZ2 (L=37 mm); AISI S2 / CrV 6150: 1/4" (6.3 mm): T8, T10, T15, T20, T25, T27, T30 (L=37 mm); AISI S2 / CrV 6150: 1/4" (6.3 mm): 3, 4, 5, 6 mm (L=37 mm); AISI S2 / CrV 6150: 1.5, 2, 2.5 mm; CrV 6150

| YATO     | 1/2" (12.7 mm) | 1/4" (6.3 mm) | 2 |
|----------|----------------|---------------|---|
| YT-38791 |                |               |   |



109  
PCS

CrV  
6140

BMC & COLOR SLEEVE  
XXL SIZE



1/2" (12.7 mm): 12, 13, 14, 15, 16, 17, 18, 19, 20, 21, 22, 24 mm (L=38 mm); 27, 30, 32 mm (L=42 mm); 1/4" (6.3 mm): 4, 4.5, 5, 5.5, 6, 7, 8, 9, 10, 11, 12, 13, 14 mm (L=25 mm); CrV 50BV30: 1/2" (12.7 mm): 10, 12, 13, 14, 17, 19 mm (L=76 mm); 1/4" (6.3 mm): 4, 5, 6, 7, 8, 9 mm (L=50 mm); CrV 50BV30: 1/2" (12.7 mm): E10, E12, E14, E16, E18, E20, E22, E24; CrV 6150: 1/2" (12.7 mm): (254 mm); 1/4" (6.3 mm): (152.4 mm); CrV 50BV30: 3/8" (9.5 mm) (F) x 1/2" (12.7 mm) (M); 3/8" (9.5 mm) (F) x 1/4" (6.3 mm) (M); CrV 50BV30: 1/2" (12.7 mm); 1/4" (6.3 mm); CrV 50BV30: 1/2" (12.7 mm): 16, 21 mm; CrV 50BV30: 1/2" (12.7 mm): (255 mm); 1/4" (6.3 mm); (155 mm); 72T; CrMo 440: 1/4" (6.3 mm); (150 mm); CrV 50BV30: 1/4" (6.3 mm): PH1, PH2, PH3 (L=37 mm); AISI S2 / CrV 6150: 1/4" (6.3 mm): PZ2, PZ3 (L=37 mm); AISI S2 / CrV 6150: 1/4" (6.3 mm): T8, T10, T15, T20, T25 (L=37 mm); AISI S2 / CrV 6150: 1/4" (6.3 mm): T10, T15, T20, T25, T40 (L=37 mm); AISI S2 / CrV 6150: 1/4" (6.3 mm): 3, 4, 5, 6 mm (L=37 mm); AISI S2 / CrV 6150: 8, 9, 10, 11, 12, 13, 14, 15, 16, 17, 18, 19 mm; CrV: 8x9, 10x11, 12x13, 14x15 mm; CrV 50BV30: 8x10, 12x13, 17x19 mm; CrV 6140: 3x75, 4x100, 6x150, PH1x75, PH2x100, PH3x150 mm; S2: 180 mm; 160 mm; 300 g

| YATO     | 1/2" (12.7 mm) | 1/4" (6.3 mm) | 2 |
|----------|----------------|---------------|---|
| YT-38891 |                |               |   |







GB Tool set  
D Sechskant-Steckschlüssel-Satz  
PL Zestaw narzędziowy  
RUS Набор инструмента

CZ Sada nástrčných klíčů a ráčny  
H Dugókulcs készlet racsnis hajtókarral  
RO Rotirusa chei tubulare cu antrenor  
F Coffret d'outillage

I Set di utensili  
E Juego de herramientas  
CN 套筒扳手套装

BMC & COLOR SLEEVE  
XL SIZE



|                |              |               |
|----------------|--------------|---------------|
| 1/2"<br>12.5mm | 3/8"<br>10mm | 1/4"<br>6.3mm |
| CrV<br>50BV30  | CrV<br>6150  | CrMo<br>440   |
| S2             | 72T          | AS-DRIVE      |

2

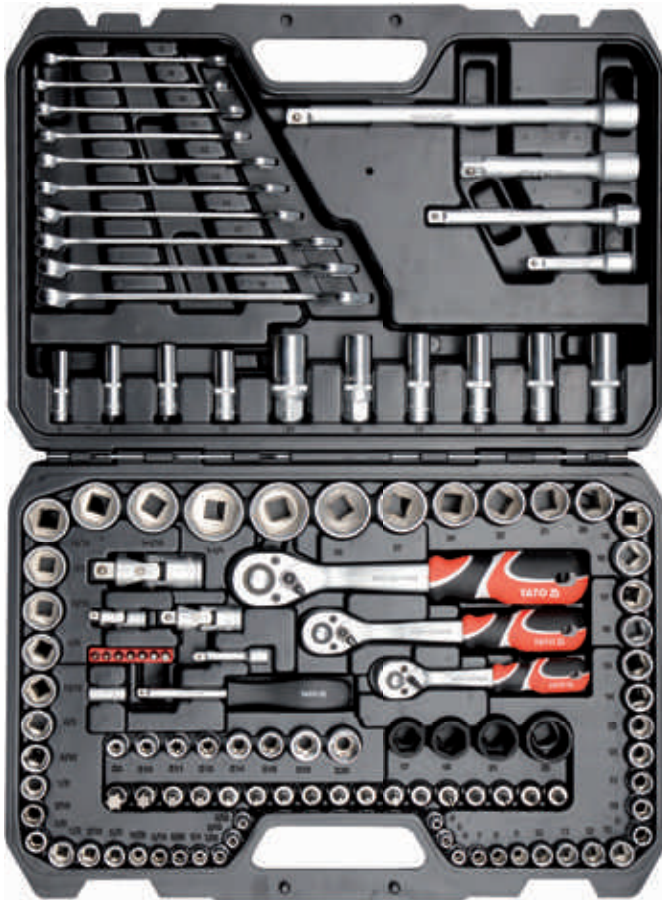

120  
PCS

METRIC  
& S.A.E.

1/2" (12.7 mm): 20, 21, 22, 24 mm (L=38 mm); 27, 30, 32 mm (L=42 mm), 3/8" (9.5 mm): 9, 10, 11, 12, 13, 14, 15, 16 mm (L=28 mm); 17, 18, 19 mm (L=30 mm), 1/4" (6.3 mm): 4, 5, 6, 7, 8, 9, 10, 11, 12, 13 mm (L=25 mm); CrV 50BV30: □ 3/8" (9.5 mm): 13, 14, 15, 17 mm (L=63 mm), 1/4" (6.3 mm): 8, 9, 10, 12 mm (L=50 mm); CrV 50BV30: □ 1/2" (12.7 mm) x 15/16" (23.8 mm), 1/2" (12.7 mm) x 1" (25.4 mm), 1/2" (12.7 mm) x 1-1/16" (27.0 mm), 1/2" (12.7 mm) x 1-1/4" (31.8 mm), 3/8" (9.5 mm) x 3/8" (9.5 mm), 3/8" (9.5 mm) x 7/16" (11.1 mm), 3/8" (9.5 mm) x 1/2" (12.7 mm), 3/8" (9.5 mm) x 9/16" (14.3 mm), 3/8" (9.5 mm) x 5/8" (15.9 mm), 3/8" (9.5 mm) x 11/16" (17.5 mm), 3/8" (9.5 mm) x 3/4" (19.0 mm), 3/8" (9.5 mm) x 13/16" (20.6 mm), 3/8" (9.5 mm) x 7/8" (22.2 mm), 1/4" (6.3 mm) x 5/32" (4.0 mm), 1/4" (6.3 mm) x 3/16" (4.8 mm), 1/4" (6.3 mm) x 7/32" (5.6 mm), 1/4" (6.3 mm) x 1/4" (6.3 mm), 1/4" (6.3 mm) x 9/32" (7.1 mm), 1/4" (6.3 mm) x 5/16" (7.9 mm), 1/4" (6.3 mm) x 11/32" (8.7 mm), 1/4" (6.3 mm) x 3/8" (9.5 mm), 1/4" (6.3 mm) x 7/16" (11.1 mm), 1/4" (6.3 mm) x 1/2" (12.7 mm); CrV 50BV30: □ 1/2" (12.7 mm): 17, 19, 21, 23 mm; CrV 50BV30: □ 3/8" (9.5 mm): E8, E10, E11, E12, E14, E16, E18, E20; CrV 6150: □ 1/2" (12.7 mm): (127, 254 mm), 3/8" (9.5 mm): (76, 152.4 mm), 1/4" (6.3 mm): (50.8 mm); CrV 50BV30: □ 1/2" (12.7 mm), 3/8" (9.5 mm), 1/4" (6.3 mm); CrV 50BV30: □ 3/8" (9.5 mm): 16, 21 mm; CrV 50BV30: □ 1/2" (12.7 mm): (255 mm), 3/8" (9.5 mm): (200 mm), 1/4" (6.3 mm): (155 mm); 72T; CrMo 440: □ 1/4" (6.3 mm): (150 mm); CrV 50BV30: □ 1/4" (6.3 mm) x 1/4" (6.3 mm); CrV 50BV30: □ 1/4" (6.3 mm): T10, T15, T20, T25, T27, T30, T40 (L=25 mm); AISI S2: □ 3/8" (9.5 mm): 5.5, 6.5 mm (L=50 mm); AISI S2 / CrV 6150: □ 3/8" (9.5 mm): PH1, PH2 (L=50 mm); AISI S2 / CrV 6150: □ 3/8" (9.5 mm): PZ1, PZ2 (L=50 mm); AISI S2 / CrV 6150: □ 3/8" (9.5 mm): T20, T30, T40, T45, T50, T55, T60 (L=50 mm); AISI S2 / CrV 6150: □ 3/8" (9.5 mm): 3, 4, 5, 6 mm (L=50 mm); AISI S2 / CrV 6150: □ 3/8" (9.5 mm): 8, 9, 10, 11, 12, 13, 14, 17, 18, 19 mm; CrV

|          |                |               |               |   |
|----------|----------------|---------------|---------------|---|
| YATO     | □              | □             | □             | □ |
| YT-38801 | 1/2" (12.7 mm) | 3/8" (9.5 mm) | 1/4" (6.3 mm) | 2 |



128  
PCS

1/2" (12.7 mm): 14, 15, 16, 17, 18, 19, 20, 21, 22, 24 mm (L=38 mm); 27, 30, 32 mm (L=42 mm), 3/8" (9.5 mm): 10, 11, 12, 13, 14, 15, 16 mm (L=28 mm); 17, 18 mm (L=30 mm), 1/4" (6.3 mm): 6, 7, 8, 9, 10, 11, 12, 13 mm (L=25 mm); CrV 50BV30: □ 1/2" (12.7 mm): 17, 18, 19, 22 mm (L=76 mm), 3/8" (9.5 mm): 8, 10, 12, 13, 14, 15 mm (L=63 mm), 1/4" (6.3 mm): 6, 7, 8, 10, 12, 13 mm (L=50 mm); CrV 50BV30: □ 1/2" (12.7 mm): 17, 19, 21, 22 mm; CrV 50BV30: □ 3/8" (9.5 mm): E8, E10, E11, E12, E14, E16; CrV 6150: □ 1/2" (12.7 mm): (127, 254 mm), 3/8" (9.5 mm): (152.4, 254 mm), 1/4" (6.3 mm): (50.8, 101.6 mm); CrV 50BV30: □ 3/8" (9.5 mm) (F) x 1/2" (12.7 mm) (M); CrV 50BV30: □ 1/2" (12.7 mm), 3/8" (9.5 mm), 1/4" (6.3 mm); CrV 50BV30: □ 1/2" (12.7 mm): 16, 21 mm; CrV 50BV30: □ 3/8" (9.5 mm): (198 mm), 1/4" (6.3 mm): (152.4 mm); CrV 50BV30: □ 1/2" (12.7 mm): (255 mm), 3/8" (9.5 mm): (200 mm), 1/4" (6.3 mm): (155 mm); 72T; CrMo 440: □ 1/4" (6.3 mm): (150 mm); CrV 50BV30: □ 1/2" (12.7 mm): (255 mm); CrV 50BV30: □ 3/8" (9.5 mm) x 5/16" (7.9 mm); CrV 50BV30: □ 1/2" (12.7 mm) x 3/8" (9.5 mm), 3/8" (9.5 mm) x 1/4" (6.3 mm); CrV 50BV30: □ 1/4" (6.3 mm) x 1/4" (6.3 mm); CrV 50BV30: □ 3/8" (9.5 mm): 5.5, 6.5 mm (L=70 mm); AISI S2: □ 3/8" (9.5 mm): PH1, PH2, PH3 (L=70 mm); AISI S2: □ 3/8" (9.5 mm): T20, T30, T40, T45, T50, T55 (L=70 mm); AISI S2: □ 3/8" (9.5 mm): 6, 7, 8, 10, 12 mm (L=70 mm); AISI S2: □ 1/4" (6.3 mm): PZ1, PZ2 (L=25 mm); AISI S2: □ 1/4" (6.3 mm): T8, T10 (L=25 mm); AISI S2: □ 1/4" (6.3 mm): 4.0, 5.5, 6.5 mm (L=37 mm); AISI S2 / CrV 6150: □ 1/4" (6.3 mm): PH1, PH2 (L=37 mm); AISI S2 / CrV 6150: □ 1/4" (6.3 mm): T8, T10, T15, T20, T25, T30, T40 (L=37 mm); AISI S2 / CrV 6150: □ 1/4" (6.3 mm): 3, 4, 5, 6 mm (L=37 mm); AISI S2 / CrV 6150: □ 1/4" (6.3 mm): 8, 10, 12, 13, 14, 15, 16, 17, 18, 19 mm; CrV: □ 1.5, 2, 2.5 mm; CrV 6150

|          |                |               |               |   |
|----------|----------------|---------------|---------------|---|
| YATO     | □              | □             | □             | □ |
| YT-38872 | 1/2" (12.7 mm) | 3/8" (9.5 mm) | 1/4" (6.3 mm) | 2 |



GB Tool set  
 D Sechskant-Steckschlüssel-Satz  
 PL Zestaw narzędziowy  
 RUS Набор инструмента

CZ Sada nástrčných klíčů a ráčny  
 H Dugókulcs készlet racsnis hajtókarral  
 RO Rotruasa chei tubulare cu antrenor  
 F Coffret d'outillage

I Set di utensili  
 E Juego de herramientas  
 CN 套筒扳手组套

BMC & COLOR  
 SLEEVE  
 XXL SIZE



|                |              |               |
|----------------|--------------|---------------|
| 1/2"<br>12.5mm | 3/8"<br>10mm | 1/4"<br>6.3mm |
| CrV<br>50BV30  | CrV<br>6150  | CrMo<br>440   |
| S2             | 72T          | AS-DRIVE      |

2



**129**  
PCS

1/2" (12.7 mm): 12, 13, 14, 15, 16, 17, 18, 19, 20, 21, 22, 24 mm (L=38 mm); 27, 30, 32 mm (L=42 mm), 3/8" (9.5 mm): 10, 11, 12, 13, 14, 15, 16 mm (L=28 mm); 17, 18, 19 mm (L=30 mm), 1/4" (6.3 mm): 4, 4.5, 5, 5.5, 6, 7, 8, 9, 10, 11, 12, 13, 14 mm (L=25 mm); CrV 50BV30: 1/2" (12.7 mm): 10, 12, 13, 14, 17, 19 mm (L=76 mm), 1/4" (6.3 mm): 4, 5, 6, 7, 8, 9 mm (L=50 mm); CrV 50BV30: 1/2" (12.7 mm): 17, 19, 21, 23 mm; CrV 50BV30: 3/8" (9.5 mm): E8, E10, E11, E12, E14, E16, E18, E20; CrV 6150: 1/2" (12.7 mm): (127, 254 mm), 3/8" (9.5 mm): (76, 152.4 mm), 1/4" (6.3 mm): (50.8 mm); CrV 50BV30: 1/2" (12.7 mm), 3/8" (9.5 mm), 1/4" (6.3 mm); CrV 50BV30: 3/8" (9.5 mm): 16, 21 mm; CrV 50BV30: 1/2" (12.7 mm): (255 mm), 3/8" (9.5 mm): (200 mm), 1/4" (6.3 mm): (155 mm); 72T; CrMo 440: 1/4" (6.3 mm): (150 mm); CrV 50BV30: 1/4" (6.3 mm): 3/8" (9.5 mm): 4, 5.5, 6.5 mm (L=50 mm); AISI S2 / CrV 6150: 3/8" (9.5 mm): PH1, PH2, PH3 (L=50 mm); AISI S2 / CrV 6150: 3/8" (9.5 mm): PZ1, PZ2, PZ3 (L=50 mm); AISI S2 / CrV 6150: 3/8" (9.5 mm): T20, T30, T40, T45, T50, T55, T60 (L=50 mm); AISI S2 / CrV 6150: 3/8" (9.5 mm): 3, 4, 5, 6, 8, 10 mm (L=50 mm); AISI S2 / CrV 6150: 8, 10, 11, 12, 13, 14, 15, 16, 17, 18, 19, 22 mm; CrV: 3x75, 4x100, 6x150, PH1x75, PH2x100, PH3x150 mm; S2: 160 mm; CrV 6150: 160 mm; 1.5, 2, 2.5, 3, 4, 5, 6, 7, 8, 10 mm; CrV 6150

| YATO     | 1/2" (12.7 mm) | 3/8" (9.5 mm) | 1/4" (6.3 mm) | 2 |
|----------|----------------|---------------|---------------|---|
| YT-38881 |                |               |               |   |



**150**  
PCS

METRIC & S.A.E.  
CrV 6140

1/2" (12.7 mm): 20, 21, 22, 24 mm (L=38 mm); 27, 30, 32 mm (L=42 mm), 3/8" (9.5 mm): 9, 10, 11, 12, 13, 14, 15, 16 mm (L=28 mm); 17, 18, 19 mm (L=30 mm), 1/4" (6.3 mm): 4, 5, 6, 7, 8, 9, 10, 11, 12, 13 mm (L=25 mm); CrV 50BV30: 1/2" (12.7 mm): 10, 12, 13, 14, 17, 19 mm (L=76 mm), 3/8" (9.5 mm): 10, 11, 12, 13, 14, 15 mm (L=63 mm), 1/4" (6.3 mm): 4, 5, 6, 7, 8, 9 mm (L=50 mm); CrV 50BV30: 1/2" (12.7 mm) x 15/16" (23.8 mm), 1/2" (12.7 mm) x 1" (25.4 mm), 1/2" (12.7 mm) x 1-1/16" (27.0 mm), 1/2" (12.7 mm) x 1-1/4" (31.8 mm), 3/8" (9.5 mm) x 3/8" (9.5 mm), 3/8" (9.5 mm) x 7/16" (11.1 mm), 3/8" (9.5 mm) x 1/2" (12.7 mm), 3/8" (9.5 mm) x 9/16" (14.3 mm), 3/8" (9.5 mm) x 5/8" (15.9 mm), 3/8" (9.5 mm) x 11/16" (17.5 mm), 3/8" (9.5 mm) x 3/4" (19.0 mm), 3/8" (9.5 mm) x 13/16" (20.6 mm), 3/8" (9.5 mm) x 7/8" (22.2 mm), 1/4" (6.3 mm) x 5/32" (4.0 mm), 1/4" (6.3 mm) x 3/16" (4.8 mm), 1/4" (6.3 mm) x 7/32" (5.6 mm), 1/4" (6.3 mm) x 1/4" (6.3 mm), 1/4" (6.3 mm) x 9/32" (7.1 mm), 1/4" (6.3 mm) x 5/16" (7.9 mm), 1/4" (6.3 mm) x 11/32" (8.7 mm), 1/4" (6.3 mm) x 3/8" (9.5 mm), 1/4" (6.3 mm) x 7/16" (11.1 mm), 1/4" (6.3 mm) x 1/2" (12.7 mm); CrV 50BV30: 1/2" (12.7 mm): 17, 19, 21, 23 mm; CrV 50BV30: 3/8" (9.5 mm): E8, E10, E11, E12, E14, E16, E18, E20; CrV 6150: 1/2" (12.7 mm): (127, 254 mm), 3/8" (9.5 mm): (76, 152.4 mm), 1/4" (6.3 mm): (50.8 mm); CrV 50BV30: 1/2" (12.7 mm), 3/8" (9.5 mm), 1/4" (6.3 mm); CrV 50BV30: 3/8" (9.5 mm): 16, 21 mm; CrV 50BV30: 1/2" (12.7 mm): (255 mm), 3/8" (9.5 mm): (200 mm), 1/4" (6.3 mm): (155 mm); 72T; CrMo 440: 1/4" (6.3 mm): (150 mm); CrV 50BV30: 1/4" (6.3 mm): 3/8" (9.5 mm): 4, 5.5, 6.5 mm (L=50 mm); CrV 50BV30: 1/4" (6.3 mm): T10, T15, T20, T25, T27, T30, T40 (L=25 mm); AISI S2: 3/8" (9.5 mm): PH1, PH2, PH3 (L=50 mm); AISI S2 / CrV 6150: 3/8" (9.5 mm): PZ1, PZ2, PZ3 (L=50 mm); AISI S2 / CrV 6150: 3/8" (9.5 mm): T20, T30, T40, T45, T50, T55, T60 (L=50 mm); AISI S2 / CrV 6150: 3/8" (9.5 mm): 3, 4, 5, 6, 8, 10 mm (L=50 mm); AISI S2 / CrV 6150: 8x10, 12x13, 17x19 mm; CrV 6140: 1.5, 2, 2.5, 3, 4, 5, 6, 7, 8, 10 mm; CrV 6150

| YATO     | 1/2" (12.7 mm) | 3/8" (9.5 mm) | 1/4" (6.3 mm) | 2 |
|----------|----------------|---------------|---------------|---|
| YT-38811 |                |               |               |   |



GB Tool set  
D Sechskant-Steckschlüssel-Satz  
PL Zestaw narzędziowy  
RUS Набор инструмента

CZ Sada nástrčných klíčů a ráčny  
H Dugókulcs készlet racsni hajtókarral  
RO Rotruasa chei tubulare cu antrenor  
F Coffret d'outillage

I Set di utensili  
E Juego de herramientas  
CN 套筒扳手组套

|                |              |               |               |             |
|----------------|--------------|---------------|---------------|-------------|
| 1/2"<br>12.5mm | 3/8"<br>10mm | 1/4"<br>6.3mm | CrV<br>50BV30 | CrV<br>6150 |
| CrV<br>40      | CrMo<br>440  | S2            | 72T           | AS-DRIVE    |

2



173  
PCS

BMC & COLOR  
SLEEVE  
XL SIZE



1/2" (12.7 mm): 10, 11, 12, 13, 14, 15, 16, 17, 18, 19, 20, 21, 22, 23, 24 mm (L=38 mm); 27, 30, 32 mm (L=42 mm); 3/8" (9.5 mm): 10, 11, 12, 13, 14, 15, 16 mm (L=28 mm); 17, 18, 19 mm (L=30 mm); 1/4" (6.3 mm): 4, 4.5, 5, 5.5, 6, 7, 8, 9, 10, 11, 12, 13, 14 mm (L=25 mm); CrV 50BV30: 1/2" (12.7 mm): 16, 17, 18, 19, 22 mm (L=76 mm); 3/8" (9.5 mm): 10, 11, 12, 13, 14, 15 mm (L=63 mm); 1/4" (6.3 mm): 4, 5, 6, 7, 8, 9, 10 mm (L=50 mm); CrV 50BV30: 1/2" (12.7 mm): E18, E20, E24, 3/8" (9.5 mm): E10, E11, E12, E14, E16, 1/4" (6.3 mm): E4, E5, E6, E7, E8; CrV 6150: 1/2" (12.7 mm): (127, 254 mm); 3/8" (9.5 mm): (152.4 mm); 1/4" (6.3 mm): (50.8, 101.6 mm); CrV 50BV30: 3/8" (9.5 mm) (F) x 1/2" (12.7 mm): CrV 50BV30; 1/2" (12.7 mm), 3/8" (9.5 mm), 1/4" (6.3 mm); CrV 50BV30: 1/2" (12.7 mm): 16, 21 mm, 3/8" (9.5 mm): 18 mm; CrV 50BV30: 1/4" (6.3 mm); (152.4 mm); CrV 40; 1/2" (12.7 mm): (255 mm); 3/8" (9.5 mm): (200 mm); 1/4" (6.3 mm): (155 mm); 72T; CrMo 440: 1/4" (6.3 mm): (150 mm); CrV 50BV30: 1/2" (12.7 mm) x 5/16" (7.9 mm), 3/8" (9.5 mm) x 5/16" (7.9 mm); CrV 50BV30: 1/4" (6.3 mm) x 1/4" (6.3 mm); CrV 50BV30: 5/16" (7.9 mm); 8, 10, 12 mm (L=30 mm); AISI S2: 5/16" (7.9 mm): PH3, PH4 (L=30 mm); AISI S2: 5/16" (7.9 mm): PZ3, PZ4 (L=30 mm); AISI S2: 5/16" (7.9 mm): T40, T45, T50, T55, T60, T70 (L=30 mm); AISI S2: 5/16" (7.9 mm): T40, T45, T50, T55, T60, T70 (L=30 mm); AISI S2: 5/16" (7.9 mm): 7, 8, 10, 12, 14 mm (L=30 mm); AISI S2: 1/4" (6.3 mm): T5, T6, T7 (L=25 mm); AISI S2: 1/4" (6.3 mm): T7, T10, T15, T20, T25, T27, T30, T40, T45 (L=25 mm); AISI S2: 1/4" (6.3 mm): M5, M6, M8 (L=25 mm); AISI S2: 1/4" (6.3 mm): RM5, RM6, RM7, RM8, RM9 (L=25 mm); AISI S2: 1/4" (6.3 mm): 4, 5, 5.5, 6, 7 mm (L=37 mm); AISI S2 / CrV 6150: 1/4" (6.3 mm): PH0, PH1, PH2 (L=37 mm); AISI S2 / CrV 6150: 1/4" (6.3 mm): PZ0, PZ1, PZ2 (L=37 mm); AISI S2 / CrV 6150: 1/4" (6.3 mm): T8, T9, T10, T15, T20, T25, T27, T30 (L=37 mm); AISI S2 / CrV 6150: 1/4" (6.3 mm): T8, T9, T10, T15, T20, T25, T27, T30 (L=37 mm); AISI S2 / CrV 6150: 1/4" (6.3 mm): 3, 4, 5, 6 mm (L=37 mm); AISI S2 / CrV 6150: 1.25, 1.5, 2, 2.5, 3, 4, 5 mm; CrV 6150

| YATO     | 1/2" (12.7 mm) | 3/8" (9.5 mm) | 1/4" (6.3 mm) | 2 |
|----------|----------------|---------------|---------------|---|
| YT-38931 |                |               |               |   |

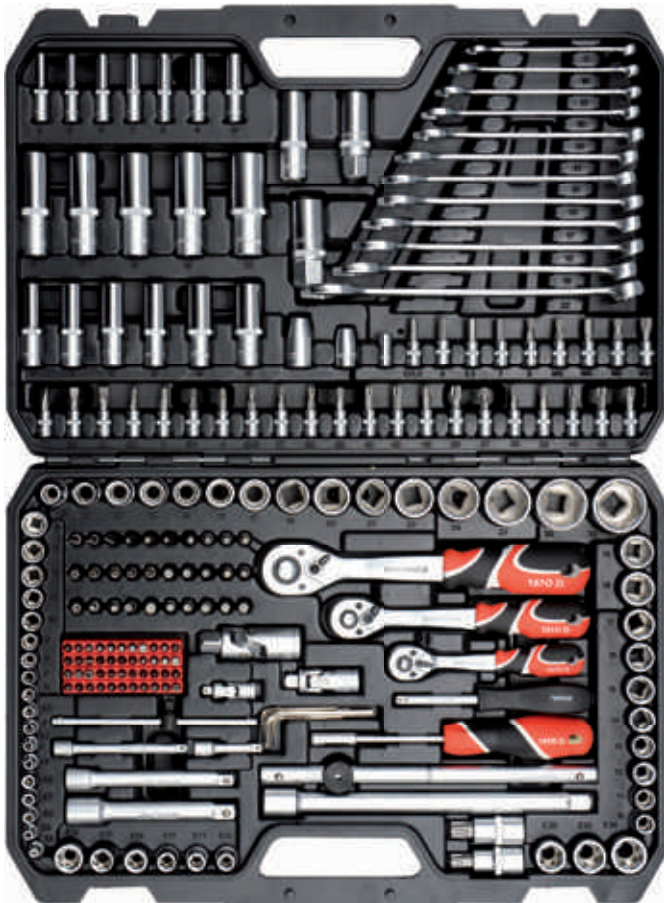

216  
PCS



BMC & COLOR  
SLEEVE  
XXL SIZE



1/2" (12.7 mm): 10, 11, 12, 13, 14, 15, 17, 19, 20, 21, 22, 24 mm (L=38 mm); 27, 30, 32 mm (L=42 mm); 3/8" (9.5 mm): 10, 11, 12, 13, 14, 15, 16 mm (L=28 mm); 17, 18, 19 mm (L=30 mm); 1/4" (6.3 mm): 4, 4.5, 5, 5.5, 6, 7, 8, 9, 10, 11, 12, 13, 14 mm (L=25 mm); CrV 50BV30: 1/2" (12.7 mm): 16, 17, 18, 19, 22 mm (L=76 mm); 3/8" (9.5 mm): 10, 11, 12, 13, 14, 15 mm (L=63 mm); 1/4" (6.3 mm): 4, 5, 6, 7, 8, 9, 10 mm (L=50 mm); CrV 50BV30: 1/2" (12.7 mm): E20, E22, E24, 3/8" (9.5 mm): E10, E11, E12, E14, E16, E18, 1/4" (6.3 mm): E4, E5, E6, E7, E8; CrV 6150: 1/2" (12.7 mm): (127, 254 mm); 3/8" (9.5 mm): (125 mm); 1/4" (6.3 mm): (50.8, 101.6 mm); CrV 50BV30: 1/2" (12.7 mm), 3/8" (9.5 mm), 1/4" (6.3 mm); CrV 50BV30: 1/2" (12.7 mm): 16, 21 mm, 3/8" (9.5 mm): 18 mm; CrV 50BV30: 1/2" (12.7 mm); (255 mm); 1/4" (6.3 mm): (152.4 mm); CrV 40; 1/2" (12.7 mm): (255 mm); 3/8" (9.5 mm): (200 mm); 1/4" (6.3 mm): (155 mm); 72T; CrMo 440: 1/4" (6.3 mm): (150 mm); CrV 50BV30: 1/4" (6.3 mm): (200 mm); CrV 6150: 1/2" (12.7 mm) x 5/16" (7.9 mm), 3/8" (9.5 mm) x 5/16" (7.9 mm); CrV 50BV30: 1/4" (6.3 mm) x 1/4" (6.3 mm); CrV 50BV30: 5/16" (7.9 mm); 6, 6.5, 8 mm (L=30 mm); AISI S2: 5/16" (7.9 mm): PH3, PH4 (L=30 mm); AISI S2: 5/16" (7.9 mm): PZ3, PZ4 (L=30 mm); AISI S2: 5/16" (7.9 mm): T25, T27, T30, T35, 2xT40, T45, T50 (L=30 mm); AISI S2: 5/16" (7.9 mm): T27, T30, T35, T40, T45, T50 (L=30 mm); AISI S2: 5/16" (7.9 mm): 5, 5.5, 6, 6.5, 7, 8 mm (L=30 mm); AISI S2: 5/16" (7.9 mm): M5, M6, M8, M10 (L=30 mm); AISI S2: 1/4" (6.3 mm): 4, 5, 5.5, 6 mm (L=25 mm); AISI S2: 1/4" (6.3 mm): PH1, PH2 (L=25 mm); AISI S2: 1/4" (6.3 mm): PZ1, PZ2 (L=25 mm); AISI S2: 1/4" (6.3 mm): T8, T10, T15, T20, T25 (L=25 mm); AISI S2: 1/4" (6.3 mm): T8, 2xT10, 2xT15, 2xT20, 2xT25, T40 (L=25 mm); AISI S2: 1/4" (6.3 mm): 3, 4, 5, 6 mm (L=25 mm); AISI S2: 1/4" (6.3 mm): 3, 4, 5, 6 mm (L=25 mm); AISI S2: 1/4" (6.3 mm): M5, M6, M8 (L=25 mm); AISI S2: 1/4" (6.3 mm): S1, S2 (L=25 mm); AISI S2: 1/4" (6.3 mm): 1, 2, 3 mm (L=25 mm); AISI S2: 1/4" (6.3 mm): 6, 8, 10 mm (L=25 mm); AISI S2: 1/4" (6.3 mm): 4, 6, 8 mm (L=25 mm); AISI S2: 1/2" (12.7 mm): T55, T60 (L=50 mm); AISI S2 / CrV 6150: 1/4" (6.3 mm): 6, 6.5, 8 mm (L=37 mm); AISI S2 / CrV 6150: 1/4" (6.3 mm): PH3, PH4 (L=37 mm); AISI S2 / CrV 6150: 1/4" (6.3 mm): PZ3, PZ4 (L=37 mm); AISI S2 / CrV 6150: 1/4" (6.3 mm): T27, T30, T35, T40, T45, T50 (L=37 mm); AISI S2 / CrV 6150: 1/4" (6.3 mm): 5.5, 6, 6.5, 7, 8 mm (L=37 mm); AISI S2 / CrV 6150: 1/4" (6.3 mm): M5, M6, M8, M10 (L=37 mm); AISI S2 / CrV 6150: 1.25, 1.5, 2, 2.5, 3, 4, 5 mm; CrV 6150

| YATO     | 1/2" (12.7 mm) | 3/8" (9.5 mm) | 1/4" (6.3 mm) | 2 |
|----------|----------------|---------------|---------------|---|
| YT-38841 |                |               |               |   |



GB Tool set  
 D Sechskant-Steckschlüssel-Satz  
 PL Zestaw narzędziowy  
 RUS Набор инструментов  
 CZ Sada nástrčných kľúčů a ráčny  
 H Dugókulcs készlet racsnis hajtókarral

RO Rotrușă de tubulare cu antrenor  
 F Coffret d'outillage  
 I Set di utensili  
 E Juego de herramientas  
 CN 套筒扳手组套

BMC & COLOR  
 SLEEVE  
 XXXL SIZE



|                    |                |              |               |
|--------------------|----------------|--------------|---------------|
| 225<br>PCS         | 1/2"<br>12.5mm | 3/8"<br>10mm | 1/4"<br>6.3mm |
| METRIC<br>& S.A.E. | CrV<br>50BV30  | CrV<br>6150  | CrV<br>6140   |
|                    | CrV<br>40      | CrMo<br>440  | S2            |
|                    | 72T            | AS-DRIVE     |               |
|                    |                |              | MAGNETIC      |



1/2" (12.7 mm): 10, 13, 15, 16, 17, 18, 19, 20, 21, 22, 23, 24 mm (L=38 mm); 27, 30, 32 mm (L=42 mm); 3/8" (9.5 mm): 10, 11, 12, 13, 14, 15, 16 mm (L=28 mm); 17, 18, 19 mm (L=30 mm); 1/4" (6.3 mm): 3.5, 4, 4.5, 5, 5.5, 6, 7, 8, 9, 10, 11, 12, 13, 14 mm (L=25 mm); CrV 50BV30: 1/2" (12.7 mm): 10, 11, 12, 13, 14, 15, 17, 19, 21 mm (L=76 mm); 3/8" (9.5 mm): 6, 7, 8, 9, 10 mm (L=63 mm); CrV 50BV30: 1/2" (12.7 mm) x 7/16" (11.1 mm), 1/2" (12.7 mm) x 1/2" (12.7 mm), 1/2" (12.7 mm) x 9/16" (14.3 mm), 1/2" (12.7 mm) x 5/8" (15.9 mm), 1/2" (12.7 mm) x 11/16" (17.5 mm), 1/2" (12.7 mm) x 3/4" (19.0 mm), 1/2" (12.7 mm) x 13/16" (20.6 mm), 1/2" (12.7 mm) x 7/8" (22.2 mm), 1/4" (6.3 mm) x 1/4" (6.3 mm), 1/4" (6.3 mm) x 9/32" (7.1 mm), 1/4" (6.3 mm) x 5/16" (7.9 mm), 1/4" (6.3 mm) x 11/32" (8.7 mm), 1/4" (6.3 mm) x 3/8" (9.5 mm); CrV 50BV30: 1/2" (12.7 mm): 17, 19, 21 mm; CrV 50BV30: 1/2" (12.7 mm): E16, E18, E20, E22, E24, 3/8" (9.5 mm): E10, E11, E12, E14, 1/4" (6.3 mm): E4, E5, E6, E7, E8; CrV 6150: 1/2" (12.7 mm): (127, 254 mm), 3/8" (9.5 mm): (76, 254 mm), 1/4" (6.3 mm): (50.8, 101.6 mm); CrV 50BV30: 3/8" (9.5 mm) (F) x 1/2" (12.7 mm) (M), 1/2" (12.7 mm) (F) x 3/8" (9.5 mm) (M); CrV 50BV30: 1/2" (12.7 mm), 3/8" (9.5 mm), 1/4" (6.3 mm); CrV 50BV30: 1/2" (12.7 mm): 16, 21 mm (L=64 mm); 3/8" (9.5 mm): 18 mm (L=63 mm); CrV 50BV30: 1/4" (6.3 mm): (152.4 mm); CrV 40: 1/2" (12.7 mm): (255 mm), 3/8" (9.5 mm): (200 mm), 1/4" (6.3 mm): (155 mm); 72T: CrMo 440: 1/4" (6.3 mm): (150 mm); CrV 50BV30: 1/4" (6.3 mm): (200 mm); CrV 6140: 1/2" (12.7 mm) x 1/16" (7.9 mm), 3/8" (9.5 mm) x 5/16" (7.9 mm), 3/8" (9.5 mm) x 1/4" (6.3 mm); CrV 50BV30: 1/4" (6.3 mm) x 1/4" (6.3 mm); CrV 50BV30: 1/4" (6.3 mm) x 3/8" (9.5 mm) (L=50 mm), 1/4" (6.3 mm) x 1/4" (6.3 mm) (L=50 mm), 1/4" (6.3 mm) x 1/4" (6.3 mm) (L=25 mm); CrV 50BV30: 1/4" (6.3 mm) (L=60 mm); 5/16" (7.9 mm): T20, T25, T27, T30, T40, T45, T50, T55 (L=75 mm); AISI S2: 5/16" (7.9 mm): 8, 10 mm (L=30 mm); AISI S2: 5/16" (7.9 mm): PH3, PH4 (L=30 mm); AISI S2: 5/16" (7.9 mm): PZ3, PZ4 (L=30 mm); AISI S2: 5/16" (7.9 mm): T40, T45, T50, T55, T60, T70 (L=30 mm); AISI S2: 5/16" (7.9 mm): T40, T45, T50, T55, T60, T70 (L=30 mm); AISI S2: 5/16" (7.9 mm): 10, 12, 14 mm (L=30 mm); AISI S2: 1/4" (6.3 mm): 3, 4, 5.5, 6.5, 7, 8, 9 mm (L=25 mm); AISI S2: 1/4" (6.3 mm): PH0, PH1, PH2, PH3 (L=25 mm); AISI S2: 1/4" (6.3 mm): PZ0, PZ1, PZ2, PZ3 (L=25 mm); AISI S2: 1/4" (6.3 mm): T8, T9, T10, T15, T20, T25, T27, T30 (L=25 mm); AISI S2: 1/4" (6.3 mm): T8, T9, T10, T15, T20, T25, T27, T30 (L=25 mm); AISI S2: 1/4" (6.3 mm): 3, 4, 5, 6, 7, 8 mm; (L=25 mm); AISI S2: 1/4" (6.3 mm): 3, 4, 5, 6, 7, 8 mm (L=25 mm); AISI S2: 1/4" (6.3 mm): 4, 5, 6, 7, 8 mm (L=25 mm); AISI S2: 1/4" (6.3 mm): TW1, TW2, TW3, TW4 (L=25 mm); AISI S2: 1/4" (6.3 mm): 6, 8, 10 mm (L=25 mm); : 1/4" (6.3 mm): 4, 6, 8, 10 mm (L=25 mm); AISI S2: 8, 9, 10, 11, 12, 13, 14, 15, 16, 17, 19, 22 mm; CrV: 6x38, PH2X38: S2: 180 mm; 250 mm; CrV: 2, 2.5, 3, 4, 5, 6, 7, 8, 10, 12 mm; CrV 6150

|          |                |               |               |   |
|----------|----------------|---------------|---------------|---|
| YATO     |                |               |               |   |
| YT-38941 | 1/2" (12.7 mm) | 3/8" (9.5 mm) | 1/4" (6.3 mm) | 2 |





- GB Socket set  
D Sechskant-Steckschlüssel-Satz  
PL Komplet nasadek długich  
RUS Набор насадок
- CZ Sada nástrčných klíčů  
H Dugókulcs készlet  
RO Trusă chei tubulare  
F Set de douilles longues
- I Serie di chiavi a bussola lunghi  
E Juego de herramientas  
CN 长套筒组套

|          |               |               |          |
|----------|---------------|---------------|----------|
| 8<br>PCS | 1/4"<br>6.3mm | CrV<br>50BV30 | AS-DRIVE |
|----------|---------------|---------------|----------|



1/4" (6.3 mm): 5.5, 6, 7, 8, 9, 10, 12, 13 mm (L=50 mm); CrV 50BV30



|             |               |    |
|-------------|---------------|----|
| <b>YATO</b> | 1/4" (6.3 mm) | 10 |
| YT-1443     | 1/4" (6.3 mm) | 10 |

- GB Tool set  
D Sechskant-Steckschlüssel-Satz  
PL Zestaw narzędziowy  
RUS Набор инструмента  
CZ Sada nástrčných klíčů a ráčny  
H Dugókulcs készlet racsnis hajtókkal
- RO Rotrușă chei tubulare cu antrenor  
F Coffret d'outillage  
I Set di utensili  
E Juego de herramientas  
CN 套筒扳手组套

METAL CASE & COLOR SLEEVE



|               |               |             |                 |
|---------------|---------------|-------------|-----------------|
| 1/4"<br>6.3mm | CrV<br>50BV30 | CrV<br>6140 | 72T<br>AS-DRIVE |
|---------------|---------------|-------------|-----------------|



15  
PCS

1/4" (6.3 mm): 4, 5, 6, 7, 8, 9, 10, 12, 13 mm (L=25 mm); CrV 50BV30;  
1/4" (6.3 mm): (50.8, 152.4 mm); CrV 50BV30;  
1/4" (6.3 mm); CrV 50BV30;  
1/4" (6.3 mm): (127 mm); 72T; CrV 6140;  
1/4" (6.3 mm): (150 mm); CrV 50BV30;

|             |               |    |
|-------------|---------------|----|
| <b>YATO</b> | 1/4" (6.3 mm) | 10 |
| YT-1441     | 1/4" (6.3 mm) | 10 |



23  
PCS

1/4" (6.3 mm): 4, 5, 6, 7, 8, 9, 10, 12, 13 mm (L=25 mm); CrV 50BV30;  
1/4" (6.3 mm): 4, 5, 6, 7, 8, 9, 10, 12, 13 mm (L=50 mm); CrV 50BV30;  
1/4" (6.3 mm): (50.8, 152.4 mm); CrV 50BV30;  
1/4" (6.3 mm); CrV 50BV30;  
1/4" (6.3 mm): (127 mm); 72T; CrV 6140;  
1/4" (6.3 mm): (150 mm); CrV 50BV30

|             |               |    |
|-------------|---------------|----|
| <b>YATO</b> | 1/4" (6.3 mm) | 10 |
| YT-1442     | 1/4" (6.3 mm) | 10 |



GB Tool set  
 D Sechskant-Steckschlüssel-Satz  
 PL Zestaw narzędziowy  
 RUS Набор инструментов  
 CZ Sada nástrčných kľučí a ráčny  
 H Dugókulcs készlet racsnis hajtókarral

RO Rotrua chei tubulare cu antrenor  
 F Coffret d'outillage  
 I Set di utensili  
 E Juego de herramientas  
 CN 套筒扳手组套

BMC & COLOR SLEEVE  
 XS SIZE



1/4"  
6.3mm  
CrV  
50BV30  
CrV  
6140  
72T  
AS-DRIVE

2



15  
PCS

1/4" (6.3 mm): 4, 5, 6, 7, 8, 9, 10, 12, 13 mm (L=25 mm); CrV 50BV30;  
 1/4" (6.3 mm): (50.8, 152.4 mm); CrV 50BV30;  
 1/4" (6.3 mm): CrV 50BV30;  
 1/4" (6.3 mm): (155 mm); 72T; CrV 6140;  
 1/4" (6.3 mm): (150 mm); CrV 50BV30

| YATO    |               |    |
|---------|---------------|----|
| YT-1444 | 1/4" (6.3 mm) | 10 |



20  
PCS

1/4" (6.3 mm): 3.5, 4, 4.5, 5, 5.5, 6, 7, 8, 9, 10, 11, 12, 13, 14 mm  
 (L=25 mm); CrV 50BV30;  
 1/4" (6.3 mm): (50.8, 152.4 mm); CrV 50BV30;  
 1/4" (6.3 mm): CrV 50BV30;  
 1/4" (6.3 mm): (152.4 mm); CrV 50BV30;  
 1/4" (6.3 mm): (155 mm); 72T; CrV 6140;  
 1/4" (6.3 mm): (150 mm); CrV 50BV30

| YATO    |               |    |
|---------|---------------|----|
| YT-1449 | 1/4" (6.3 mm) | 10 |



23  
PCS

1/4" (6.3 mm): 4, 5, 6, 7, 8, 9, 10, 12, 13 mm (L=25 mm); CrV 50BV30;  
 1/4" (6.3 mm): 4, 5, 6, 7, 8, 9, 10, 12, 13 mm (L=50 mm); CrV 50BV30;  
 1/4" (6.3 mm): (50.8, 152.4 mm); CrV 50BV30;  
 1/4" (6.3 mm); CrV 50BV30;  
 1/4" (6.3 mm): (155 mm); 72T; CrV 6140;  
 1/4" (6.3 mm): (150 mm); CrV 50BV30

| YATO    |               |    |
|---------|---------------|----|
| YT-1445 | 1/4" (6.3 mm) | 10 |



GB Tool set  
D Sechskant-Steckschlüssel-Satz  
PL Zestaw narzędziowy  
RUS Набор инструмента  
CZ Sada nástrčných klíčů a ráčny  
H Dugókulcs készlet racsnis hajtókkal

RO Rotrusa chei tubulare cu antrenor  
F Coffret d'outillage  
I Set di utensili  
E Juego de herramientas  
CN 套筒扳手组套

BMC & COLOR SLEEVE  
XS SIZE



1/4"  
6.3mm

CrV  
50BV30

CrV  
6140

72T

AS-DRIVE

2



25  
PCS

1/4" (6.3 mm): 3.5, 4, 4.5, 5, 5.5, 6, 7, 8, 9, 10, 11, 12, 13, 14 mm (L=25 mm); CrV 50BV30;  
1/4" (6.3 mm): 8, 10, 11, 12, 13 mm (L=50 mm); CrV 50BV30;  
1/4" (6.3 mm): (50.8, 101.6 mm); CrV 50BV30;  
1/4" (6.3 mm): CrV 50BV30;  
1/4" (6.3 mm): (152.4 mm); CrV 50BV30;  
1/4" (6.3 mm): (155 mm); 72T; CrV 6140;  
1/4" (6.3 mm): (150 mm); CrV 50BV30

| YATO    |               |    |
|---------|---------------|----|
| YT-1446 | 1/4" (6.3 mm) | 10 |



38  
PCS

CrV  
6150

S2

1/4" (6.3 mm): 3.5, 4, 4.5, 5, 5.5, 6, 7, 8, 9, 10, 11, 12, 13, 14 mm (L=25 mm); CrV 50BV30;  
1/4" (6.3 mm): (50.8, 101.6 mm); CrV 50BV30;  
1/4" (6.3 mm): (152.4 mm); CrV 50BV30;  
1/4" (6.3 mm): (155 mm); 72T; CrV 6140;  
1/4" (6.3 mm): (150 mm); CrV 50BV30;  
1/4" (6.3 mm): 4, 5.5, 6.5 mm (L=37 mm); AISI S2 / CrV 6150;  
1/4" (6.3 mm): PH1, PH2 (L=37 mm); AISI S2 / CrV 6150;  
1/4" (6.3 mm): PZ1, PZ2 (L=37 mm); AISI S2 / CrV 6150;  
1/4" (6.3 mm): T10, T15, T20, T25, T30, T40 (L=37 mm); AISI S2 / CrV 6150;  
1/4" (6.3 mm): 3, 4, 5, 6, 8 mm (L=37 mm); AISI S2 / CrV 6150

| YATO    |               |    |
|---------|---------------|----|
| YT-1447 | 1/4" (6.3 mm) | 10 |



42  
PCS

CrV  
6150

S2

1/4" (6.3 mm): 4, 4.5, 5, 5.5, 6, 7, 8, 9, 10, 11, 12, 13, 14 mm (L=25 mm); CrV 50BV30;  
1/4" (6.3 mm): 8, 9, 10, 11, 12, 13 mm (L=50 mm); CrV 50BV30;  
1/4" (6.3 mm): (50.8, 101.6 mm); CrV 50BV30;  
1/4" (6.3 mm): (150 mm); CrV 6140;  
1/4" (6.3 mm): (152.4 mm); CrV 50BV30;  
1/4" (6.3 mm): (155 mm); 72T; CrV 6140;  
1/4" (6.3 mm): (150 mm); CrV 50BV30;  
1/4" (6.3 mm) x 1/4" (6.3 mm); CrV 6140;  
1/4" (6.3 mm): 3, 4, 5 mm (L=25 mm); AISI S2;  
1/4" (6.3 mm): PH0, PH1, PH2 (L=25 mm); AISI S2;  
1/4" (6.3 mm): PZ0, PZ1, PZ2 (L=25 mm); AISI S2;  
1/4" (6.3 mm): 6, 7, 8 mm (L=25 mm); AISI S2;  
1.5, 2, 2.5 mm; CrV 6150

| YATO    |               |   |
|---------|---------------|---|
| YT-1448 | 1/4" (6.3 mm) | 6 |



GB Tool set  
 D Sechskant-Steckschlüssel-Satz  
 PL Zestaw narzędziowy  
 RUS Набор инструмента  
 CZ Sada nástrčných kľučí a ráčny  
 H Dugókulcs készlet racsnis hajtókarral

RO Rotrușă de tubulare cu antrenor  
 F Coffret d'outillage  
 I Set di utensili  
 E Juego de herramientas  
 CN 套筒扳手組套

BMC & COLOR SLEEVE  
 XS SIZE



|           |               |               |
|-----------|---------------|---------------|
| 56<br>PCS | 1/4"<br>6.3mm | CrV<br>50BV30 |
|           | CrV<br>6150   | CrV<br>6140   |
|           | S2            | 72T           |
|           |               | AS-DRIVE      |

2



1/4" (6.3 mm): 4, 4.5, 5, 5.5, 6, 7, 8, 9, 10, 11, 12, 13 mm (L=25 mm); CrV 50BV30;  
 1/4" (6.3 mm): 6, 7, 8, 9, 10, 11, 12, 13 mm (L=50 mm); CrV 50BV30; 1/4" (6.3 mm): E4, E5, E6, E7, E8, E10; CrV 50BV30; 1/4" (6.3 mm): (76, 152.4 mm); CrV 50BV30; 1/4" (6.3 mm): (150 mm); CrV 6140; 1/4" (6.3 mm); CrV 50BV30; 1/4" (6.3 mm): (152.4 mm); CrV 50BV30;  
 1/4" (6.3 mm): (155 mm); 72T; CrV 6140; 1/4" (6.3 mm): (150 mm); CrV 50BV30; 1/4" (6.3 mm) (F) x 3/8" (9.5 mm) (M); CrV 50BV30;  
 1/4" (6.3 mm): 4, 5, 5, 6.5 mm (L=37 mm); AISI S2 / CrV 6150; 1/4" (6.3 mm): PH1, PH2, PH3 (L=37 mm); AISI S2 / CrV 6150; 1/4" (6.3 mm): PZ1, PZ2, PZ3 (L=37 mm); AISI S2 / CrV 6150; 1/4" (6.3 mm): T8, T10, T15, T20, T25, T30, T40 (L=37 mm); AISI S2 / CrV 6150; 1/4" (6.3 mm): 3, 4, 5, 6, 7, 8 mm (L=37 mm); AISI S2 / CrV 6150

|             |               |    |
|-------------|---------------|----|
| <b>YATO</b> |               |    |
| YT-1450     | 1/4" (6.3 mm) | 10 |



GB Socket set  
 D Sechskant-Steckschlüssel-Satz  
 PL Komplet nasadek dlugich  
 RUS Набор насадок

CZ Sada nástrčných klíčů  
 H Dugókulcs készlet  
 RO Trusă chei tubulare  
 F Set de douilles longues

I Serie di chiavi a bussola lunghi  
 E Juego de herramientas  
 CN 长套筒组套

9 PCS  
 3/8" 10mm  
 CrV 50BV30  
 AS-DRIVE



3/8" (9.5 mm): 8, 10, 11, 12, 13, 14, 16, 17, 19 mm (L=63 mm); CrV 50BV30

PLASTIC HANGER



|             |               |    |
|-------------|---------------|----|
| <b>YATO</b> | 3/8" (9.5 mm) | 10 |
| YT-3855     |               |    |

GB Tool set  
 D Sechskant-Steckschlüssel-Satz  
 PL Zestaw narzędziowy  
 RUS Набор инструмента

CZ Sada nástrčných klíčů a ráčny  
 H Dugókulcs készlet racsnis hajtókarral  
 RO Rotrusa chei tubulare cu antrenor  
 F Coffret d'outillage

I Set di utensili  
 E Juego de herramientas  
 CN 套筒扳手组套

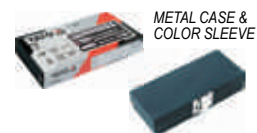

METAL CASE & COLOR SLEEVE

3/8" 10mm  
 CrV 50BV30  
 CrV 6140  
 72T  
 AS-DRIVE



15 PCS

3/8" (9.5 mm): 10, 11, 12, 13, 14, 15 (L=28 mm); 17, 19, 21, 22 mm (L=30 mm); CrV 50BV30;  
 3/8" (9.5 mm): (76, 152.4 mm); CrV 50BV30;  
 3/8" (9.5 mm): 16, 21 mm; CrV 50BV30;  
 3/8" (9.5 mm): (200 mm); 72T; CrV 6140

|             |               |    |
|-------------|---------------|----|
| <b>YATO</b> | 3/8" (9.5 mm) | 10 |
| YT-38631    |               |    |

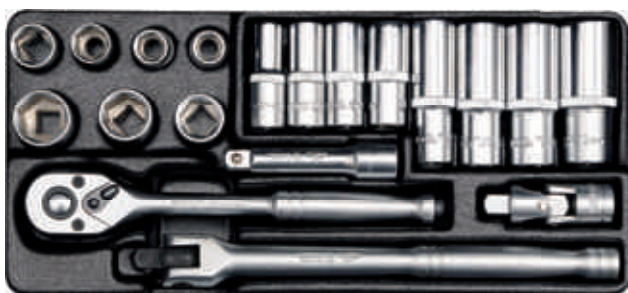

19 PCS

3/8" (9.5 mm): 10, 11, 13, 14, 15 (L=28 mm); 17, 19 mm (L=30 mm); CrV 50BV30;  
 3/8" (9.5 mm): 10, 11, 12, 13 mm (L=46 mm); 14, 15, 17, 19 mm (L=63 mm); CrV 50BV30;  
 3/8" (9.5 mm): (76 mm); CrV 50BV30; 3/8" (9.5 mm); CrV 50BV30;  
 3/8" (9.5 mm): (200 mm); 72T; CrV 6140;  
 3/8" (9.5 mm): (215 mm); CrV 50BV30

|             |               |   |
|-------------|---------------|---|
| <b>YATO</b> | 3/8" (9.5 mm) | 8 |
| YT-38641    |               |   |

GB Tool set  
 D Sechskant-Steckschlüssel-Satz  
 PL Zestaw narzędziowy  
 RUS Набор инструмента  
 CZ Sada nástrčných klíčů a ráčny  
 H Dugókulcs készlet racsnis hajtókarral

RO Rotrusa chei tubulare cu antrenor  
 F Coffret d'outillage  
 I Set di utensili  
 E Juego de herramientas  
 CN 套筒扳手组套

BMC & COLOR SLEEVE  
 XS SIZE



22 PCS  
 3/8" 10mm  
 CrV 50BV30  
 CrV 6140  
 72T  
 AS-DRIVE



3/8" (9.5 mm): 6, 7, 8, 9, 10, 11, 12, 13, 14, 15, 16 mm (L=28 mm); 17, 18, 19, 20, 21, 22 mm (L=30 mm); CrV 50BV30;  
 3/8" (9.5 mm): (76, 152.4 mm); CrV 50BV30;  
 3/8" (9.5 mm): CrV 50BV30;  
 3/8" (9.5 mm): (198 mm); CrV 50BV30;  
 3/8" (9.5 mm): (200 mm); 72T; CrV 6140

|             |               |    |
|-------------|---------------|----|
| <b>YATO</b> | 3/8" (9.5 mm) | 10 |
| YT-3856     |               |    |



GB Tool set  
 D Sechskant-Steckschlüssel-Satz  
 PL Zestaw narzędziowy  
 RUS Набор инструмента  
 CZ Sada nástrčných klíčů a ráčny  
 H Dugókulcs készlet racsnis hajtókarral

RO Rotrușă de chei tubulare cu antrenor  
 F Coffret d'outillage  
 I Set di utensili  
 E Juego de herramientas  
 CN 套筒扳手组套

BMC & COLOR SLEEVE  
 M SIZE



|             |               |               |
|-------------|---------------|---------------|
| 58<br>PCS   | 3/8"<br>10 mm | CrV<br>50BV30 |
| CrV<br>6150 | CrV<br>6140   |               |
| S2          | 72T           |               |
| AS-DRIVE    |               |               |

2



3/8" (9.5 mm): 6, 7, 8, 9, 10, 11, 12, 13, 14, 15, 16 mm (L=28 mm); 17, 18, 19, 20, 21, 22, 24 mm (L=30 mm); CrV 50BV30: 3/8" (9.5 mm): 8, 10, 11, 12, 13, 14, 15, 17, 19 mm (L=63 mm); CrV 50BV30: 3/8" (9.5 mm): (76, 254 mm); CrV 50BV30: 3/8" (9.5 mm); CrV 50BV30: 3/8" (9.5 mm): 16, 21 mm; CrV 50BV30: 3/8" (9.5 mm): (200 mm); 72T; CrV 6140: 1/2" (12.7 mm) (F) x 3/8" (9.5 mm) (M); CrV 50BV30: 3/8" (9.5 mm): 5.5, 6.5, 8 mm (L=50 mm); AISI S2 / CrV 6150: 3/8" (9.5 mm): PH1, PH2, PH3 (L=50 mm); AISI S2 / CrV 6150: 3/8" (9.5 mm): PZ1, PZ2 (L=50 mm); AISI S2 / CrV 6150: 3/8" (9.5 mm): T10, T15, T20, T25, T30, T40, T45, T50, T55 (L=50 mm); AISI S2 / CrV 6150: 3/8" (9.5 mm): 3, 4, 5, 6, 7, 8, 10 mm (L=50 mm); AISI S2 / CrV 6150

|             |               |   |
|-------------|---------------|---|
| <b>YATO</b> |               |   |
| YT-3857     | 3/8" (9.5 mm) | 6 |



GB Socket set  
D Sechskant-Steckschlüssel-Satz  
PL Komplet nasadek dlugich  
RUS Набор насадок

CZ Sada nástrčných klíčů  
H Dugókulcs készlet  
RO Trusă chei tubulare  
F Set de douilles longues

I Serie di chiavi a bussola lunghi  
E Juego de herramientas  
CN 长套筒组套

10 PCS 1/2" 12.5mm CrV 50BV30 AS-DRIVE



1/2" (12.7 mm): 10, 12, 13, 14, 15, 17, 19, 21, 22, 24 mm (L=76 mm); CrV 50BV30

PLASTIC HANGER

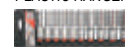

|             |                |    |
|-------------|----------------|----|
| <b>YATO</b> |                |    |
| YT-3886     | 1/2" (12.7 mm) | 10 |

GB Ratchet handle with socket set  
D Sechskant-Steckschlüssel-Satz  
PL Komplet nasadek z grzechotką  
RUS Набор насадок

CZ Sada nástrčných klíčů a ráčny  
H Dugókulcs készlet racsnis hajtókarral  
RO Rotrusa chei tubulare cu antrenor  
F Clé mixte à cliquet + douilles

I Serie di chiavi con cricchetto  
E Matraca con boquillas  
CN 套筒扳手组套

PLASTIC HANGER



12 PCS 1/2" 12.5mm CrV 50BV30  
CrV 6140 72T AS-DRIVE



1/2" (12.7 mm): 10, 11, 12, 13, 14, 15, 17, 19, 21, 24 mm (L=38 mm); CrV 50BV30;  
1/2" (12.7 mm): (127 mm); CrV 50BV30;  
1/2" (12.7 mm): (255 mm); 72T; CrV 6140

|             |                |    |
|-------------|----------------|----|
| <b>YATO</b> |                |    |
| YT-3882     | 1/2" (12.7 mm) | 10 |

GB Ratchet handle with socket set  
D Sechskant-Steckschlüssel-Satz  
PL Komplet nasadek z grzechotką  
RUS Набор насадок

CZ Sada nástrčných klíčů a ráčny  
H Dugókulcs készlet racsnis hajtókarral  
RO Rotrusa chei tubulare cu antrenor  
F Clé mixte à cliquet + douilles

I Serie di chiavi con cricchetto  
E Matraca con boquillas  
CN 套筒扳手组套

PLASTIC HANGER



19 PCS 1/2" 12.5mm CrV 50BV30  
CrV 6140 72T AS-DRIVE



1/2" (12.7 mm): 8, 9, 10, 11, 12, 13, 14, 15, 16, 17, 19, 21, 22, 23, 24 mm (L=38 mm);  
27, 30, 32 mm (L=42 mm); CrV 50BV30;  
1/2" (12.7 mm): (255 mm); 72T; CrV 6140

|             |                |   |
|-------------|----------------|---|
| <b>YATO</b> |                |   |
| YT-3868     | 1/2" (12.7 mm) | 6 |

GB Ratchet handle with socket set  
D Sechskant-Steckschlüssel-Satz  
PL Komplet nasadek z grzechotką  
RUS Набор насадок

CZ Sada nástrčných klíčů a ráčny  
H Dugókulcs készlet racsnis hajtókarral  
RO Rotrusa chei tubulare cu antrenor  
F Clé mixte à cliquet + douilles

I Serie di chiavi con cricchetto  
E Matraca con boquillas  
CN 套筒扳手组套

PLASTIC HANGER



19 PCS 1/2" 12.5mm 12pt CrV 50BV30  
CrV 6140 72T AS-DRIVE



1/2" (12.7 mm): 8, 9, 10, 11, 12, 13, 14, 15, 16, 17, 19, 21, 22, 23, 24 mm (L=38 mm);  
27, 30, 32 mm (L=42 mm); CrV 50BV30;  
1/2" (12.7 mm): (255 mm); 72T; CrV 6140

|             |                |   |
|-------------|----------------|---|
| <b>YATO</b> |                |   |
| YT-38682    | 1/2" (12.7 mm) | 6 |

GB Tool set  
D Sechskant-Steckschlüssel-Satz  
PL Zestaw narzędziowy  
RUS Набор инструмента

CZ Sada nástrčných klíčů a ráčny  
H Dugókulcs készlet racsnis hajtókarral  
RO Rotrusa chei tubulare cu antrenor  
F Coffret d'outillage

I Set di utensili  
E Juego de herramientas  
CN 套筒扳手组套



1/2" 12.5mm CrV 50BV30 CrV 6140  
72T AS-DRIVE



12 PCS

1/2" (12.7 mm): 10, 11, 12, 13, 14, 15, 17, 19, 21, 24 mm (L=38 mm); CrV 50BV30;  
1/2" (12.7 mm): (125 mm); CrV 50BV30;  
1/2" (12.7 mm): (250 mm); 72T; CrV 6140

|             |                |   |
|-------------|----------------|---|
| <b>YATO</b> |                |   |
| YT-12621    | 1/2" (12.7 mm) | 8 |



GB Tool set  
D Sechskant-Steckschlüssel-Satz  
PL Zestaw narzędziowy  
RUS Набор инструмента

CZ Sada nástrčných kľúčů a ráčny  
H Dugókulcs készlet racsnis hajtókarral  
RO Rotrușa chei tubulare cu antrenor  
F Coffret d'outillage

I Set di utensili  
E Juego de herramientas  
CN 套筒扳手套



METAL CASE & COLOR SLEEVE

1/2"  
12.5mm

CrV  
50BV30

CrV  
6140

72T

AS-DRIVE

2



18  
PCS

1/2" (12.7 mm): 11, 13, 14, 15, 17, 19, 21, 22, 23, 24 mm (L=38 mm);  
27, 30, 32 mm (L=42 mm); CrV 50BV30;  
1/2" (12.7 mm); (125 mm); CrV 50BV30;  
1/2" (12.7 mm): 16, 21 mm; CrV 50BV30;  
1/2" (12.7 mm); (250 mm); 72T; CrV 6140;  
1/2" (12.7 mm); (460 mm); CrV 50BV30

|             |                |   |
|-------------|----------------|---|
| <b>YATO</b> |                |   |
| YT-12641    | 1/2" (12.7 mm) | 3 |

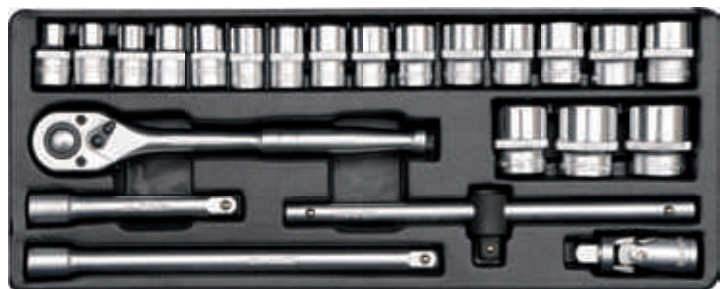

23  
PCS

1/2" (12.7 mm): 10, 11, 12, 13, 14, 15, 16, 17, 18, 19, 20, 21, 22, 23, 24 mm (L=38 mm);  
27, 30, 32 mm (L=42 mm); CrV 50BV30;  
1/2" (12.7 mm); (125, 250 mm); CrV 50BV30;  
1/2" (12.7 mm); CrV 50BV30;  
1/2" (12.7 mm); (250 mm); CrV 50BV30;  
1/2" (12.7 mm); (250 mm); 72T; CrV 6140

|             |                |   |
|-------------|----------------|---|
| <b>YATO</b> |                |   |
| YT-12651    | 1/2" (12.7 mm) | 3 |



24  
PCS

1/2" (12.7 mm): 10, 11, 12, 13, 14, 15, 16, 17, 18, 19, 20, 21, 22, 23, 24 mm (L=38 mm);  
27, 30, 32 mm (L=42 mm); CrV 50BV30;  
1/2" (12.7 mm); (125 mm); CrV 50BV30; 1/2" (12.7 mm); CrV 50BV30;  
1/2" (12.7 mm): 16, 21 mm; CrV 50BV30;  
1/2" (12.7 mm); (250 mm); CrV 50BV30;  
1/2" (12.7 mm); (250 mm); 72T; CrV 6140

|             |                |   |
|-------------|----------------|---|
| <b>YATO</b> |                |   |
| YT-12661    | 1/2" (12.7 mm) | 3 |



25  
PCS

1/2" (12.7 mm): 10, 11, 12, 13, 14, 15, 16, 17, 18, 19, 20, 21, 22, 23, 24 mm (L=38 mm);  
27, 30, 32 mm (L=42 mm); CrV 50BV30;  
1/2" (12.7 mm); (50, 125 mm); CrV 50BV30;  
1/2" (12.7 mm): 16, 21 mm; CrV 50BV30;  
1/2" (12.7 mm); (250 mm); CrV 50BV30;  
1/2" (12.7 mm); (250 mm); 72T; CrV 6140;  
1/2" (12.7 mm); (317 mm); CrV 50BV30

|             |                |   |
|-------------|----------------|---|
| <b>YATO</b> |                |   |
| YT-12671    | 1/2" (12.7 mm) | 3 |

GB Tool set  
D Sechskant-Steckschlüssel-Satz  
PL Zestaw narzędziowy  
RUS Набор инструмента

CZ Sada nástrčných kľúčů a ráčny  
H Dugókulcs készlet racsnis hajtókarral  
RO Rotrușa chei tubulare cu antrenor  
F Coffret d'outillage

I Set di utensili  
E Juego de herramientas  
CN 套筒扳手套

1/2"  
12.5mm

CrV  
50BV30

CrV  
6140

72T

AS-DRIVE



12  
PCS

1/2" (12.7 mm): 10, 11, 12, 13, 14, 15, 17, 19, 21, 24 mm  
(L=38 mm); CrV 50BV30;  
1/2" (12.7 mm); (127 mm); CrV 50BV30;  
1/2" (12.7 mm); (255 mm); 72T; CrV 6140

BMC & COLOR SLEEVE  
XS SIZE



|             |                |    |
|-------------|----------------|----|
| <b>YATO</b> |                |    |
| YT-3867     | 1/2" (12.7 mm) | 10 |



GB Tool set  
D Sechskant-Steckschlüssel-Satz  
PL Zestaw narzędziowy  
RUS Набор инструмента

CZ Sada nástrčných klíčů a ráčny  
H Dugókulcs készlet racsnis hajtókarral  
RO Rotruşa chei tubulare cu antrenor  
F Coffret d'outillage

I Set di utensili  
E Juego de herramientas  
CN 套筒扳手组套

1/2"  
12.5mm

CrV  
50BV30

CrV  
6140

72T

AS-DRIVE

2



18  
PCS

- 1/2" (12.7 mm): 11, 13, 14, 15, 17, 19, 21, 22, 23, 24 mm (L=38 mm); 27, 30, 32 mm (L=42 mm); CrV 50BV30;
- 1/2" (12.7 mm): (127 mm); CrV 50BV30;
- 1/2" (12.7 mm): 16, 21 mm; CrV 50BV30;
- 1/2" (12.7 mm): (255 mm); 72T; CrV 6140;
- 1/2" (12.7 mm): (457 mm); CrV 50BV30

BMC & COLOR SLEEVE  
S SIZE



| YATO    |                |   |
|---------|----------------|---|
| YT-3870 | 1/2" (12.7 mm) | 6 |



20  
PCS

- 1/2" (12.7 mm): 10, 11, 12, 13, 14, 15, 16, 17, 18, 19, 22, 24 mm (L=38 mm); CrV 50BV30;
- 1/2" (12.7 mm): 13, 17, 19 mm (L=76 mm); CrV 50BV30;
- 1/2" (12.7 mm): (254 mm); CrV 50BV30;
- 3/8" (9.5 mm) (F) x 1/2" (12.7 mm) (M); CrV 50BV30;
- 1/2" (12.7 mm): CrV 50BV30;
- 1/2" (12.7 mm): 16 mm; CrV 50BV30;
- 1/2" (12.7 mm): (255 mm); 72T; CrV 6140

BMC & COLOR SLEEVE  
M SIZE



| YATO    |                |   |
|---------|----------------|---|
| YT-3869 | 1/2" (12.7 mm) | 6 |



23  
PCS

- 1/2" (12.7 mm): 10, 11, 12, 13, 14, 15, 16, 17, 18, 19, 20, 21, 22, 23, 24 mm (L=38 mm); 27, 30, 32 mm (L=42 mm); CrV 50BV30;
- 1/2" (12.7 mm): (127, 254 mm); CrV 50BV30;
- 1/2" (12.7 mm); CrV 50BV30;
- 1/2" (12.7 mm): (255 mm); CrV 50BV30;
- 1/2" (12.7 mm): (255 mm); 72T; CrV 6140

BMC & COLOR SLEEVE  
M SIZE



| YATO    |                |   |
|---------|----------------|---|
| YT-3873 | 1/2" (12.7 mm) | 6 |



24  
PCS

- 1/2" (12.7 mm): 10, 11, 12, 13, 14, 15, 16, 17, 18, 19, 20, 21, 22, 23, 24 mm (L=38 mm); 27, 30, 32 mm (L=42 mm); CrV 50BV30;
- 1/2" (12.7 mm): (127 mm); CrV 50BV30;
- 1/2" (12.7 mm); CrV 50BV30;
- 1/2" (12.7 mm): 16, 21 mm; CrV 50BV30;
- 1/2" (12.7 mm): (255 mm); CrV 50BV30;
- 1/2" (12.7 mm): (255 mm); 72T; CrV 6140

BMC & COLOR SLEEVE  
M SIZE



| YATO    |                |   |
|---------|----------------|---|
| YT-3872 | 1/2" (12.7 mm) | 6 |



GB Tool set  
 D Sechskant-Steckschlüssel-Satz  
 PL Zestaw narzędziowy  
 RUS Набор инструмента

CZ Sada nástrčných klíčů a ráčny  
 H Dugókulcs készlet racsnis hajtókarral  
 RO Rotrusa chei tubulare cu antrenor  
 F Coffret d'outillage

I Set di utensili  
 E Juego de herramientas  
 CN 套筒扳手组套

1/2"  
12.5mm  
CrV  
50BV30  
CrV  
6140  
72T  
AS-DRIVE

2



25  
PCS

- 1/2" (12.7 mm): 8, 9, 10, 11, 12, 13, 14, 15, 16, 17, 18, 19, 20, 21, 22, 23, 24 mm (L=38 mm); 27, 30, 32 mm (L=42 mm); CrV 50BV30;
- 1/2" (12.7 mm): (127, 254 mm); CrV 50BV30;
- 3/8" (9.5 mm) (F) x 1/2" (12.7 mm) (M); CrV 50BV30;
- 1/2" (12.7 mm); CrV 50BV30;
- 1/2" (12.7 mm): (255 mm); 72T; CrV 6140

BMC & COLOR SLEEVE  
M SIZE



|             |                |   |
|-------------|----------------|---|
| <b>YATO</b> |                |   |
| YT-3871     | 1/2" (12.7 mm) | 6 |

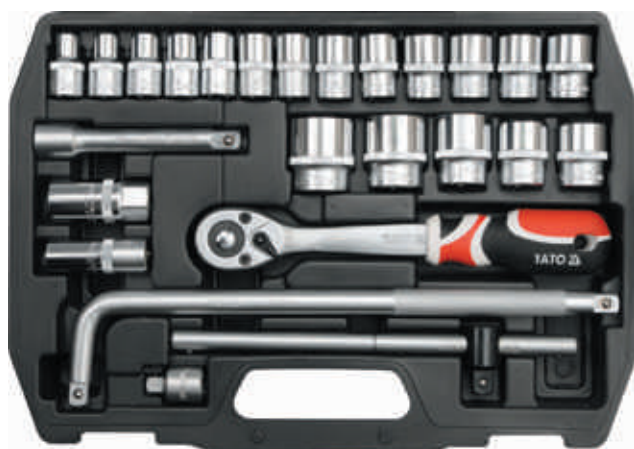

25  
PCS

- 1/2" (12.7 mm): 10, 11, 12, 13, 14, 15, 16, 17, 18, 19, 20, 21, 22, 23, 24 mm (L=38 mm); 27, 30, 32 mm (L=42 mm); CrV 50BV30;
- 1/2" (12.7 mm): (127 mm); CrV 50BV30;
- 1/2" (12.7 mm): 16, 21 mm; CrV 50BV30;
- 1/2" (12.7 mm): (255 mm); CrV 50BV30;
- 1/2" (12.7 mm): (255 mm); 72T; CrV 6140;
- 1/2" (12.7 mm): (317 mm); CrV 50BV30;
- 1/2" (12.7 mm) (F) x 3/8" (9.5 mm) (M); CrV 50BV30

BMC & COLOR SLEEVE  
L SIZE



|             |                |   |
|-------------|----------------|---|
| <b>YATO</b> |                |   |
| YT-3874     | 1/2" (12.7 mm) | 6 |



38  
PCS

- 1/2" (12.7 mm): 10, 11, 12, 13, 14, 15, 16, 17, 18, 19, 20, 21, 22, 23, 24 mm (L=38 mm); 27, 30, 32 mm (L=42 mm); CrV 50BV30;
- 1/2" (12.7 mm): 10, 13, 17, 19 mm (L=76 mm); CrV 50BV30;
- 1/2" (12.7 mm): (127, 254 mm); CrV 50BV30;
- 1/2" (12.7 mm); CrV 50BV30;
- 1/2" (12.7 mm): 16, 21 mm; CrV 50BV30;
- 1/2" (12.7 mm): (255 mm); CrV 50BV30;
- 1/2" (12.7 mm): (255 mm); 72T; CrV 6140;
- 8, 10, 11, 12, 13, 14, 17, 19, 22 mm; CrV

BMC & COLOR SLEEVE  
M SIZE



|             |                |   |
|-------------|----------------|---|
| <b>YATO</b> |                |   |
| YT-3876     | 1/2" (12.7 mm) | 6 |



GB Tool set  
D Sechskant-Steckschlüssel-Satz  
PL Zestaw narzędziowy  
RUS Набор инструмента

CZ Sada nástrčných klíčů a ráčny  
H Dugókulcs készlet racsnis hajtókarral  
RO Rotruasa chei tubulare cu antrenor  
F Coffret d'outillage

I Set di utensili  
E Juego de herramientas  
CN 套筒扳手组套

BMC & COLOR SLEEVE  
M SIZE



|                    |                |
|--------------------|----------------|
| 46<br>PCS          | 1/2"<br>12.5mm |
| METRIC<br>& S.A.E. | CrV<br>50BV30  |
| CrV<br>6140        | 72T            |
| AS-DRIVE           |                |



1/2" (12.7 mm): 8, 9, 10, 11, 12, 13, 14, 15, 16, 17, 18, 19, 20, 21, 22, 23, 24 mm (L=38 mm); 27, 30, 32 mm (L=42 mm); CrV 50BV30: 1/2" (12.7 mm): 10, 12, 13, 14, 15, 17, 19 mm (L=76 mm); CrV 50BV30: 1/2" (12.7 mm) x 3/8" (9.5 mm), 1/2" (12.7 mm) x 7/16" (11.1 mm), 1/2" (12.7 mm) x 1/2" (12.7 mm), 1/2" (12.7 mm) x 9/16" (14.3 mm), 1/2" (12.7 mm) x 5/8" (15.9 mm), 1/2" (12.7 mm) x 11/16" (17.5 mm), 1/2" (12.7 mm) x 3/4" (19.0 mm), 1/2" (12.7 mm) x 13/16" (20.6 mm), 1/2" (12.7 mm) x 7/8" (22.2 mm), 1/2" (12.7 mm) x 15/16" (23.8 mm), 1/2" (12.7 mm) x 1" (25.4 mm); CrV 50BV30: 1/2" (12.7 mm): (127, 254 mm); CrV 50BV30: 3/8" (9.5 mm) (F) x 1/2" (12.7 mm) (M); CrV 50BV30: 1/2" (12.7 mm); CrV 50BV30: 1/2" (12.7 mm): 16, 21 mm; CrV 50BV30: 1/2" (12.7 mm): (255 mm); 72T: CrV 6140: 1/2" (12.7 mm); (250 mm); CrV 50BV30

|             |                |   |
|-------------|----------------|---|
| <b>YATO</b> |                |   |
| YT-3877     | 1/2" (12.7 mm) | 6 |

GB Tool set  
D Sechskant-Steckschlüssel-Satz  
PL Zestaw narzędziowy  
RUS Набор инструмента

CZ Sada nástrčných klíčů a ráčny  
H Dugókulcs készlet racsnis hajtókarral  
RO Rotruasa chei tubulare cu antrenor  
F Coffret d'outillage

I Set di utensili  
E Juego de herramientas  
CN 套筒扳手组套

BMC & COLOR SLEEVE  
M SIZE



|               |                |               |
|---------------|----------------|---------------|
| 72<br>PCS     | 1/2"<br>12.5mm | 1/4"<br>6.3mm |
| CrV<br>50BV30 | CrV<br>6140    |               |
| 72T           | AS-DRIVE       |               |



1/2" (12.7 mm): 10, 11, 12, 13, 14, 15, 16, 17, 18, 19, 20, 21, 22, 23, 24 mm (L=38 mm); 27 mm (L=42 mm), 1/4" (6.3 mm): 4, 5, 6, 7, 8, 9, 10, 11, 12, 13 mm (L=25 mm); CrV 50BV30: 1/2" (12.7 mm): (127, 254 mm), 1/4" (6.3 mm): (152.4 mm); CrV 50BV30: 3/8" (9.5 mm) (F) x 1/2" (12.7 mm) (M); CrV 50BV30: 1/2" (12.7 mm); CrV 50BV30: 1/2" (12.7 mm): 21 mm; CrV 50BV30: 1/2" (12.7 mm): (255 mm), 1/4" (6.3 mm): (155 mm); 72T: CrV 6140: 1/4" (6.3 mm); (150 mm); CrV 50BV30: 1/4" (6.3 mm) x 1/4" (6.3 mm); CrV 6140: 1/4" (6.3 mm): 4, 5, 5.5, 6, 7 mm (L=25 mm); CrV 6150: 1/4" (6.3 mm): PH0, PH1, PH2, PH3 (L=25 mm); CrV 6150: 1/4" (6.3 mm): PZ0, PZ1, PZ2, PZ3 (L=25 mm); CrV 6150: 1/4" (6.3 mm): T8, T9, T10, T15, T20, T25, T27, T30, T40 (L=25 mm); CrV 6150: 1/4" (6.3 mm): 3, 4, 5, 6, 7, 8 mm (L=25 mm); CrV 6150: 1/4" (6.3 mm): S0, S1, S2, S3 (L=25 mm); CrV 6150: 1.25, 1.5, 2.5, 3 mm; CrV 6150

|             |                |               |
|-------------|----------------|---------------|
| <b>YATO</b> |                |               |
| YT-38782    | 1/2" (12.7 mm) | 1/4" (6.3 mm) |
|             |                | 4             |



GB Tool set  
 D Sechskant-Steckschlüssel-Satz  
 PL Zestaw narzędziowy  
 RUS Набор инструмента

CZ Sada nástrčných klíčů a ráčny  
 H Dugókulcs készlet racsnis hajtókkal  
 RO Rotrușa chei tubulare cu antrenor  
 F Coffret d'outillage

I Set di utensili  
 E Juego de herramientas  
 CN 套筒扳手组套

1/2" 12.5mm  
 1/4" 6.3mm  
 CrV 50BV30 CrV 6140  
 S2 72T  
 AS-DRIVE

2



BMC & COLOR SLEEVE L SIZE



77 PCS CrV 6150

1/2" (12.7 mm): 10, 11, 12, 13, 14, 15, 17, 19, 22, 24 mm (L=38 mm); 27, 30, 32 mm (L=42 mm), 1/4" (6.3 mm): 4, 5, 6, 7, 8, 9, 10, 11, 12 mm (L=25 mm); CrV 50BV30: 1/2" (12.7 mm): (127, 254 mm), 1/4" (6.3 mm): (76, 101.6 mm); CrV 50BV30: 1/2" (12.7 mm), 1/4" (6.3 mm); CrV 50BV30: 1/2" (12.7 mm): 16, 21 mm; CrV 50BV30: 1/2" (12.7 mm); (255 mm), 1/4" (6.3 mm); (155 mm); 72T; CrV 6140: 1/4" (6.3 mm) x 1/4" (6.3 mm); CrV 6140: 1/4" (6.3 mm) x 1/4" (6.3 mm) (L=25 mm); CrV 6140: 1/4" (6.3 mm): 3, 4, 5.5, 7 mm (L=25 mm); AISI S2: 1/4" (6.3 mm): PH0, PH1, PH2, PH3 (L=25 mm); AISI S2: 1/4" (6.3 mm): PZ1, PZ2, PZ3 (L=25 mm); AISI S2: 1/4" (6.3 mm): T10, T15, T20, T25, T30 (L=25 mm); AISI S2: 1/4" (6.3 mm): 2, 3, 4, 5, 6 mm (L=25 mm); AISI S2: 7, 8, 9, 10, 11, 12, 13, 14, 15, 17, 19 mm; CrV: 8x9, 10x11, 12x13, 14x15 mm; CrV 6140: 1.5, 2, 2.5, 5, 6, 8, 10 mm; CrV 6150

| YATO    | 1/2" (12.7 mm) | 1/4" (6.3 mm) | 2 |
|---------|----------------|---------------|---|
| YT-3878 |                |               |   |



BMC & COLOR SLEEVE XXXL SIZE



79 PCS CrV 60 CrV 55

CrMo SVCM 55 SK5

1/2" (12.7 mm): 10, 11, 12, 13, 14, 16, 17, 19, 22, 24, 26 mm (L=38 mm); 27, 30, 32 mm (L=42 mm), 1/4" (6.3 mm): 5, 6, 7, 8, 9, 10, 11, 12, 13 mm (L=25 mm); CrV 50BV30: 1/2" (12.7 mm): 10, 11, 12, 13, 14, 17, 19 mm (L=76 mm); CrV 50BV30: 1/2" (12.7 mm): (127 mm), 1/4" (6.3 mm): (50.8 mm); CrV 50BV30: 1/2" (12.7 mm); CrV 50BV30: 1/2" (12.7 mm): 16, 21 mm; CrV 50BV30: 1/2" (12.7 mm); (255 mm), 1/4" (6.3 mm); (155 mm); 72T; CrV 6140: 1/4" (6.3 mm): (150 mm); CrV 50BV30: 1/2" (12.7 mm): (420 mm); CrV 50BV30: 6, 7, 8, 9, 10, 11, 12, 13, 14, 16, 17, 19, 22, 24 mm; CrV: 2.0x40, 2.4x75 mm; S2: 3.0x75, 4.0x100, 6.5x150, 8.0x150 mm; SVCM55: PH0x75 mm; S2: PH1x75, PH2x100 mm; SVCM55: 180 mm; CrV 55: 160 mm; CrV 55: 160, 200 mm; CrV 55: 250 mm; CrV: 300 g; 300 mm; 180 mm; CrMo: 120 mm; CrV 60: SK5; 2.5, 3, 4, 5, 6, 8, 10 mm; CrV

| YATO    | 1/2" (12.7 mm) | 1/4" (6.3 mm) | 2 |
|---------|----------------|---------------|---|
| YT-3891 |                |               |   |



GB Tool set  
D Sechskant-Steckschlüssel-Satz  
PL Zestaw narzędziowy  
RUS Набор инструмента

CZ Sada nástrčných klíčů a ráčny  
H Dugókulcs készlet racsnis hajtókkal  
RO Rotrușa chei tubulare cu antrenor  
F Coffret d'outillage

I Set di utensili  
E Juego de herramientas  
CN 套筒扳手组套

BMC & COLOR SLEEVE  
L SIZE



|                |               |
|----------------|---------------|
| 1/2"<br>12.5mm | 1/4"<br>6.3mm |
| CrV<br>50BV30  | CrV<br>6150   |
| CrV<br>6140    | S2            |
| 72T            | AS-DRIVE      |

2



82  
PCS

1/2" (12.7 mm): 14, 15, 16, 17, 18, 19, 20, 22, 24 mm (L=38 mm); 27, 30, 32 mm (L=42 mm); 1/4" (6.3 mm): 4, 4.5, 5, 5.5, 6, 7, 8, 9, 10, 11, 12, 13, 14 mm (L=25 mm); CrV 50BV30: 1/2" (12.7 mm): (127, 254 mm); 1/4" (6.3 mm): (50.8, 101.6 mm); CrV 50BV30: 3/8" (9.5 mm) (F) x 1/2" (12.7 mm) (M); CrV 50BV30: 1/4" (6.3 mm): (150 mm); CrV 6140: 1/2" (12.7 mm); 1/4" (6.3 mm): CrV 50BV30: 1/2" (12.7 mm): 16, 21 mm; CrV 50BV30: 1/4" (6.3 mm): (152.4 mm); CrV 50BV30: 1/2" (12.7 mm): (255 mm); 1/4" (6.3 mm): (155 mm); 72T: CrV 6140: 1/4" (6.3 mm): (150 mm); CrV 50BV30: 1/2" (12.7 mm) x 5/16" (7.9 mm); CrV 6140: 1/4" (6.3 mm) x 1/4" (6.3 mm); CrV 6140: 5/16" (7.9 mm): 8, 10, 12 mm (L=30 mm); AISI S2: 5/16" (7.9 mm): PH3, PH4 (L=30 mm); AISI S2: 5/16" (7.9 mm): PZ3, PZ4 (L=30 mm); AISI S2: 5/16" (7.9 mm): T40, T45, T50, T55 (L=30 mm); AISI S2: 5/16" (7.9 mm): 8, 10, 12, 14 mm (L=30 mm); AISI S2: 1/4" (6.3 mm): 4, 5.5, 7 mm (L=37 mm); AISI S2 / CrV 6150: 1/4" (6.3 mm): PH1, PH2 (L=37 mm); AISI S2 / CrV 6150: 1/4" (6.3 mm): PZ1, PZ2 (L=37 mm); AISI S2 / CrV 6150: 1/4" (6.3 mm): T8, T10, T15, T20, T25, T30 (L=37 mm); AISI S2 / CrV 6150: 1/4" (6.3 mm): 3, 4, 5, 6 mm (L=37 mm); AISI S2 / CrV 6150: 8, 10, 11, 12, 13, 14, 17, 19, 22 mm; CrV

| YATO    | 1/2" (12.7 mm) | 1/4" (6.3 mm) | 4 |
|---------|----------------|---------------|---|
| YT-1269 |                |               |   |



94  
PCS

1/2" (12.7 mm): 10, 11, 12, 13, 14, 15, 16, 17, 18, 19, 20, 21, 22, 23, 24 mm (L=38 mm); 27, 30, 32 mm (L=42 mm); 1/4" (6.3 mm): 4, 4.5, 5, 5.5, 6, 7, 8, 9, 10, 11, 12, 13, 14 mm (L=25 mm); CrV 50BV30: 1/2" (12.7 mm): 14, 15, 17, 19 mm (L=76 mm); 1/4" (6.3 mm): 6, 7, 8, 9, 10, 11, 12, 13 mm (L=50 mm); CrV 50BV30: 1/2" (12.7 mm): (127, 254 mm); 1/4" (6.3 mm): (50.8, 101.6 mm); CrV 50BV30: 3/8" (9.5 mm) (F) x 1/2" (12.7 mm) (M); CrV 50BV30: 1/4" (6.3 mm): (150 mm); CrV 6140: 1/2" (12.7 mm); 1/4" (6.3 mm); CrV 50BV30: 1/2" (12.7 mm): 16, 21 mm; CrV 50BV30: 1/4" (6.3 mm): (152.4 mm); CrV 50BV30: 1/2" (12.7 mm): (255 mm); 1/4" (6.3 mm): (155 mm); 72T: CrV 6140: 1/4" (6.3 mm): (150 mm); CrV 50BV30: 1/2" (12.7 mm) x 5/16" (7.9 mm); CrV 6140: 1/4" (6.3 mm) x 1/4" (6.3 mm) (L=25 mm); CrV 6140: 5/16" (7.9 mm): 8, 10, 12 mm (L=30 mm); AISI S2: 5/16" (7.9 mm): PH3, PH4 (L=30 mm); AISI S2: 5/16" (7.9 mm): PZ3, PZ4 (L=30 mm); AISI S2: 5/16" (7.9 mm): T40, T45, T50, T55 (L=30 mm); AISI S2: 1/4" (6.3 mm): 4, 5.5, 7 mm (L=37 mm); AISI S2 / CrV 6150: 1/4" (6.3 mm): PH1, PH2 (L=37 mm); AISI S2 / CrV 6150: 1/4" (6.3 mm): PZ1, PZ2 (L=37 mm); AISI S2 / CrV 6150: 1/4" (6.3 mm): T8, T10, T15, T20, T25, T30 (L=37 mm); AISI S2 / CrV 6150: 1/4" (6.3 mm): 3, 4, 5, 6 mm (L=37 mm); AISI S2 / CrV 6150: 1.5, 2.0, 2.5 mm; CrV 6150

| YATO    | 1/2" (12.7 mm) | 1/4" (6.3 mm) | 4 |
|---------|----------------|---------------|---|
| YT-1268 |                |               |   |



GB Tool set  
 D Sechskant-Steckschlüssel-Satz  
 PL Zestaw narzędziowy  
 RUS Набор инструмента

CZ Sada nástrčných klíčů a ráčny  
 H Dugókulcs készlet racsnis hajtókarral  
 RO Rotrusa chei tubulare cu antrenor  
 F Coffret d'outillage

I Set di utensili  
 E Juego de herramientas  
 CN 套筒扳手套装

BMC & COLOR SLEEVE  
 L SIZE



|               |             |
|---------------|-------------|
| 1/2"          | 1/4"        |
| 12.5mm        | 6.3mm       |
| CrV<br>50BV30 | CrV<br>6150 |
| CrV<br>6140   | S2          |
| 72T           | AS-DRIVE    |

2



94  
PCS

12pt

1/2" (12.7 mm): 10, 11, 12, 13, 14, 15, 16, 17, 18, 19, 20, 21, 22, 23, 24 mm (L=38 mm); 27, 30, 32 mm (L=42 mm), 1/4" (6.3 mm): 4, 4.5, 5, 5.5, 6, 7, 8, 9, 10, 11, 12, 13, 14 mm (L=25 mm); CrV 50BV30: 1/2" (12.7 mm): 14, 15, 17, 19 mm (L=76 mm), 1/4" (6.3 mm): 6, 7, 8, 9, 10, 11, 12, 13 mm (L=50 mm); CrV 50BV30: 1/2" (12.7 mm): (127, 254 mm), 1/4" (6.3 mm): (50.8, 101.6 mm); CrV 50BV30: 3/8" (9.5 mm) (F) x 1/2" (12.7 mm) (M); CrV 50BV30: 1/4" (6.3 mm): (150 mm); CrV 6140: 1/2" (12.7 mm), 1/4" (6.3 mm); CrV 50BV30: 1/2" (12.7 mm): 16, 21 mm; CrV 50BV30: 1/4" (6.3 mm): (152.4 mm); CrV 50BV30: 1/2" (12.7 mm): (255 mm), 1/4" (6.3 mm): (155 mm); 72T; CrV 6140: 1/4" (6.3 mm): (150 mm); CrV 50BV30: 1/2" (12.7 mm) x 5/16" (7.9 mm); CrV 6140: 1/4" (6.3 mm) x 1/4" (6.3 mm) (L=25 mm); CrV 6140: 5/16" (7.9 mm): 8, 10, 12 mm (L=30 mm); AISI S2: 5/16" (7.9 mm): PH3, PH4 (L=30 mm); AISI S2: 5/16" (7.9 mm): PZ3, PZ4 (L=30 mm); AISI S2: 5/16" (7.9 mm): T40, T45, T50, T55 (L=30 mm); AISI S2: 5/16" (7.9 mm): 8, 10, 12, 14 mm (L=30 mm); AISI S2: 1/4" (6.3 mm): 4, 5.5, 7 mm (L=37 mm); AISI S2 / CrV 6150: 1/4" (6.3 mm): PH1, PH2 (L=37 mm); AISI S2 / CrV 6150: 1/4" (6.3 mm): PZ1, PZ2 (L=37 mm); AISI S2 / CrV 6150: 1/4" (6.3 mm): T8, T10, T15, T20, T25, T30 (L=37 mm); AISI S2 / CrV 6150: 1/4" (6.3 mm): 3, 4, 5, 6 mm (L=37 mm); AISI S2 / CrV 6150: 1.5, 2.0, 2.5 mm; CrV 6150

| YATO     | 1/2"           | 1/4"          |   |
|----------|----------------|---------------|---|
| YT-12682 | 1/2" (12.7 mm) | 1/4" (6.3 mm) | 4 |



108  
PCS

1/2" (12.7 mm): 10, 11, 12, 13, 14, 15, 16, 17, 18, 19, 20, 21, 22, 24 mm (L=38 mm); 27, 30, 32 mm (L=42 mm), 1/4" (6.3 mm): 4, 4.5, 5, 5.5, 6, 7, 8, 9, 10, 11, 12, 13, 14 mm (L=25 mm); CrV 50BV30: 1/2" (12.7 mm): 14, 15, 17, 19, 22 mm (L=76 mm), 1/4" (6.3 mm): 6, 7, 8, 9, 10, 11, 12, 13 mm (L=50 mm); CrV 50BV30: 1/2" (12.7 mm): E10, E11, E12, E14, E16, E18, E20, E24, 1/4" (6.3 mm): E4, E5, E6, E7, E8; CrV 50BV30: 1/2" (12.7 mm): (127, 254 mm), 1/4" (6.3 mm): (50.8, 101.6 mm); CrV 50BV30: 3/8" (9.5 mm) (F) x 1/2" (12.7 mm) (M); CrV 50BV30: 1/2" (12.7 mm), 1/4" (6.3 mm); CrV 50BV30: 1/2" (12.7 mm): 16, 21 mm; CrV 50BV30: 1/4" (6.3 mm): (152.4 mm); CrV 50BV30: 1/2" (12.7 mm): (255 mm), 1/4" (6.3 mm): (155 mm); 72T; CrV 6140: 1/4" (6.3 mm): (150 mm); CrV 50BV30: 1/2" (12.7 mm) x 5/16" (7.9 mm); CrV 6140: 5/16" (7.9 mm): 8, 10, 12 mm (L=30 mm); AISI S2: 5/16" (7.9 mm): PH3, PH4 (L=30 mm); AISI S2: 5/16" (7.9 mm): PZ3, PZ4 (L=30 mm); AISI S2: 5/16" (7.9 mm): T40, T45, T50, T55, T60 (L=30 mm); AISI S2: 5/16" (7.9 mm): 7, 8, 10, 12, 14 mm (L=30 mm); AISI S2: 1/4" (6.3 mm): 4, 5.5, 6.5 mm (L=37 mm); AISI S2 / CrV 6150: 1/4" (6.3 mm): PH1, PH2 (L=37 mm); AISI S2 / CrV 6150: 1/4" (6.3 mm): PZ1, PZ2 (L=37 mm); AISI S2 / CrV 6150: 1/4" (6.3 mm): T8, T10, T15, T20, T25, T27, T30 (L=37 mm); AISI S2 / CrV 6150: 1/4" (6.3 mm): 3, 4, 5, 6 mm (L=37 mm); AISI S2 / CrV 6150: 1.5, 2.0, 2.5 mm; CrV 6150

| YATO    | 1/2"           | 1/4"          |   |
|---------|----------------|---------------|---|
| YT-3879 | 1/2" (12.7 mm) | 1/4" (6.3 mm) | 2 |



GB Tool set  
D Sechskant-Steckschlüssel-Satz  
PL Zestaw narzędziowy  
RUS Набор инструмента

CZ Sada nástrčných klíčů a ráčny  
H Dugókulcs készlet racsnis hajtókarral  
RO Rotirusa chei tubulare cu antrenor  
F Coffret d'outillage

I Set di utensili  
E Juego de herramientas  
CN 套筒扳手组套

BMC & COLOR SLEEVE  
XXL SIZE



|               |             |
|---------------|-------------|
| 1/2"          | 1/4"        |
| 12.5mm        | 6.3mm       |
| CrV<br>50BV30 | CrV<br>6150 |
| CrV<br>6140   | CrV<br>55   |
| SVCM<br>55    | S2          |
| 72T           | AS-DRIVE    |

2



109  
PCS

1/2" (12.7 mm): 12, 13, 14, 15, 16, 17, 18, 19, 20, 21, 22, 24 mm (L=38 mm); 27, 30, 32 mm (L=42 mm), 1/4" (6.3 mm): 4, 4.5, 5, 5.5, 6, 7, 8, 9, 10, 11, 12, 13, 14 mm (L=25 mm); CrV 50BV30: 1/2" (12.7 mm): 10, 12, 13, 14, 17, 19 mm (L=76 mm), 1/4" (6.3 mm): 4, 5, 6, 7, 8, 9 mm (L=50 mm); CrV 50BV30: 1/2" (12.7 mm): E10, E12, E14, E16, E18, E20, E22, E24; CrV 50BV30: 1/2" (12.7 mm): (254 mm), 1/4" (6.3 mm): (152.4 mm); CrV 50BV30: 3/8" (9.5 mm) (F) x 1/2" (12.7 mm) (M), 3/8" (9.5 mm) (F) x 1/4" (6.3 mm) (M); CrV 50BV30: 1/2" (12.7 mm), 1/4" (6.3 mm); CrV 50BV30: 1/2" (12.7 mm): 16, 21 mm; CrV 50BV30: 1/2" (12.7 mm): (255 mm), 1/4" (6.3 mm): (155 mm); 72T; CrV 6140: 1/4" (6.3 mm): (150 mm); CrV 50BV30: 1/4" (6.3 mm): 4.0, 5.5, 6.5 mm (L=37 mm); AISI S2 / CrV 6150: 1/4" (6.3 mm): PH1, PH2, PH3 (L=37 mm); AISI S2 / CrV 6150: 1/4" (6.3 mm): PZ2, PZ3 (L=37 mm); AISI S2 / CrV 6150: 1/4" (6.3 mm): T8, T10, T15, T20, T25 (L=37 mm); AISI S2 / CrV 6150: 1/4" (6.3 mm): T10, T15, T20, T25, T40 (L=37 mm); AISI S2 / CrV 6150: 1/4" (6.3 mm): 3, 4, 5, 6 mm (L=37 mm); AISI S2 / CrV 6150: 8, 9, 10, 11, 12, 13, 14, 15, 16, 17, 18, 19 mm; CrV: 8x9, 10x11, 12x13, 14x15 mm; CrV 6140: 8x10, 12x13, 17x19 mm; CrV 6140: 3x75, 4x100, 6.5x150, PH1x75, PH2x100, PH3x150 mm; SVCM55: 180 mm; CrV 55: 300 g

| YATO    | 1/2" (12.7 mm) | 1/4" (6.3 mm) | 2 |
|---------|----------------|---------------|---|
| YT-3889 |                |               |   |



122  
PCS

1/2" (12.7 mm): 12, 13, 14, 15, 16, 17, 18, 19, 20, 21, 22, 24 mm (L=38 mm); 27, 30, 32 mm (L=42 mm), 1/4" (6.3 mm): 4, 4.5, 5, 5.5, 6, 7, 8, 9, 10, 11, 12, 13, 14 mm (L=25 mm); CrV 50BV30: 1/2" (12.7 mm): 10, 12, 13, 14, 17, 19 mm (L=76 mm), 1/4" (6.3 mm): 4, 5, 6, 7, 8, 9 mm (L=50 mm); CrV 50BV30: 1/2" (12.7 mm): E10, E12, E14, E16, E18, E20, E22, E24; CrV 50BV30: 1/2" (12.7 mm): (254 mm), 1/4" (6.3 mm): (152.4 mm); CrV 50BV30: 3/8" (9.5 mm) (F) x 1/2" (12.7 mm) (M), 3/8" (9.5 mm) (F) x 1/4" (6.3 mm) (M); CrV 50BV30: 1/2" (12.7 mm), 1/4" (6.3 mm); CrV 50BV30: 1/2" (12.7 mm): 16, 21 mm; CrV 50BV30: 1/2" (12.7 mm): (255 mm), 1/4" (6.3 mm): (155 mm); 72T; CrV 6140: 1/4" (6.3 mm): (150 mm); CrV 50BV30: 1/4" (6.3 mm) x 1/4" (6.3 mm); CrV 6140: 1/4" (6.3 mm): 3, 4, 5, 6 mm (L=25 mm); AISI S2: 1/4" (6.3 mm): PH0, PH1, PH2 (L=25 mm); AISI S2: 1/4" (6.3 mm): PZ0, PZ1, PZ2 (L=25 mm); AISI S2: 1/4" (6.3 mm): 4.0, 5.5, 6.5 mm (L=37 mm); AISI S2 / CrV 6150: 1/4" (6.3 mm): PH1, PH2, PH3 (L=37 mm); AISI S2 / CrV 6150: 1/4" (6.3 mm): PZ2, PZ3 (L=37 mm); AISI S2 / CrV 6150: 1/4" (6.3 mm): T8, T10, T15, T20, T25 (L=37 mm); AISI S2 / CrV 6150: 1/4" (6.3 mm): T10, T15, T20, T25, T40 (L=37 mm); AISI S2 / CrV 6150: 1/4" (6.3 mm): 3, 4, 5, 6 mm (L=37 mm); AISI S2 / CrV 6150: 8, 9, 10, 11, 12, 13, 14, 15, 16, 17, 18, 19 mm; CrV: 4x100, 6.5x150, PH2x100, PH3x150 mm; SVCM55: 180 mm; CrV 55: 160 mm; CrV 55: 160 mm; CrV 55: 300 g; 2, 2.5, 3, 4, 5, 6, 7, 8, 10 mm; CrV 6150

| YATO    | 1/2" (12.7 mm) | 1/4" (6.3 mm) | 2 |
|---------|----------------|---------------|---|
| YT-3890 |                |               |   |



GB Tool set  
 D Sechskant-Steckschlüssel-Satz  
 PL Zestaw narzędziowy  
 RUS Набор инструмента

CZ Sada nástrčných klíčů a ráčny  
 H Dugókulcs készlet racsnis hajtókarral  
 RO Rotrusa chei tubulare cu antrenor  
 F Coffret d'outillage

I Set di utensili  
 E Juego de herramientas  
 CN 套筒扳手组套

BMC & COLOR SLEEVE  
 XL SIZE



|                |              |               |
|----------------|--------------|---------------|
| 1/2"<br>12.5mm | 3/8"<br>10mm | 1/4"<br>6.3mm |
| CrV<br>50BV30  | CrV<br>6150  | CrV<br>6140   |
| S2             | 72T          | AS-DRIVE      |

2



**111**  
PCS

1/2" (12.7 mm): 14, 15, 16, 17, 18, 19, 20, 21, 22, 23, 24 mm (L=38 mm); 27, 30, 32 mm (L=42 mm); 3/8" (9.5 mm): 9, 10, 11, 12, 13, 14, 15, 16 mm (L=28 mm); 17, 18, 19 mm (L=30 mm); 1/4" (6.3 mm): 3.5, 4, 4.5, 5, 5.5, 6, 7, 8, 9, 10, 11, 12, 13 mm (L=25 mm); CrV 50BV30: 1/2" (12.7 mm): (127, 254 mm); 3/8" (9.5 mm): (76, 152.4 mm); 1/4" (6.3 mm): (50.8, 152.4 mm); CrV 50BV30: 3/8" (9.5 mm) (F) x 1/2" (12.7 mm) (M), 1/2" (12.7 mm) (F) x 3/8" (9.5 mm) (M), 3/8" (9.5 mm) (F) x 1/4" (6.3 mm) (M); CrV 50BV30: 1/2" (12.7 mm); 3/8" (9.5 mm); 1/4" (6.3 mm); CrV 50BV30: 1/2" (12.7 mm): 16, 21 mm; 3/8" (9.5 mm): 16, 21 mm; CrV 50BV30: 1/2" (12.7 mm); (255 mm); 3/8" (9.5 mm): (200 mm); 1/4" (6.3 mm): (155 mm); 72T: CrV 6140: 1/4" (6.3 mm): (150 mm); CrV 50BV30: 1/2" (12.7 mm) x 5/16" (7.9 mm); 3/8" (9.5 mm) x 5/16" (7.9 mm); CrV 6140: 5/16" (7.9 mm): 6, 6.5, 8 mm (L=30 mm); AISI S2: 5/16" (7.9 mm): PH2, PH3 (L=30 mm); AISI S2: 5/16" (7.9 mm): PZ2, PZ3 (L=30 mm); AISI S2: 5/16" (7.9 mm): T27, T30, T35, T40, T45 (L=30 mm); AISI S2: 5/16" (7.9 mm): 5.5, 6, 6.5 mm (L=30 mm); AISI S2: 1/4" (6.3 mm): 4, 5.5, 6.5 mm (L=37 mm); AISI S2 / CrV 6150: 1/4" (6.3 mm): PH1, PH2 (L=37 mm); AISI S2 / CrV 6150: 1/4" (6.3 mm): PZ1, PZ2 (L=37 mm); AISI S2 / CrV 6150: 1/4" (6.3 mm): T8, T10, T15, T20, T25 (L=37 mm); AISI S2 / CrV 6150: 1/4" (6.3 mm): T10, T15, T20, T25, T40 (L=37 mm); AISI S2 / CrV 6150: 1/4" (6.3 mm): 3, 4, 5, 6 mm (L=37 mm); AISI S2 / CrV 6150: 8, 9, 10, 11, 12, 13, 14, 15, 16, 17, 18, 19 mm; CrV: 1.5, 2, 2.5 mm; CrV 6150

| YATO    | 1/2" (12.7 mm) | 3/8" (9.5 mm) | 1/4" (6.3 mm) | 2 |
|---------|----------------|---------------|---------------|---|
| YT-3883 |                |               |               |   |



**120**  
PCS

METRIC  
& S.A.E.

1/2" (12.7 mm): 20, 21, 22, 24 mm (L=38 mm); 27, 30, 32 mm (L=42 mm); 3/8" (9.5 mm): 9, 10, 11, 12, 13, 14, 15, 16 mm (L=28 mm); 17, 18, 19 mm (L=30 mm); 1/4" (6.3 mm): 4, 5, 6, 7, 8, 9, 10, 11, 12, 13 mm (L=25 mm); CrV 50BV30: 3/8" (9.5 mm): 13, 14, 15, 17 mm (L=63 mm); 1/4" (6.3 mm): 8, 9, 10, 12 mm (L=50 mm); CrV 50BV30: 1/2" (12.7 mm) x 15/16" (23.8 mm); 1/2" (12.7 mm) x 1" (25.4 mm); 1/2" (12.7 mm) x 1-1/16" (27.0 mm); 1/2" (12.7 mm) x 1-1/4" (31.8 mm); 3/8" (9.5 mm) x 3/8" (9.5 mm); 3/8" (9.5 mm) x 7/16" (11.1 mm); 3/8" (9.5 mm) x 1/2" (12.7 mm); 3/8" (9.5 mm) x 9/16" (14.3 mm); 3/8" (9.5 mm) x 5/8" (15.9 mm); 3/8" (9.5 mm) x 11/16" (17.5 mm); 3/8" (9.5 mm) x 3/4" (19.0 mm); 3/8" (9.5 mm) x 13/16" (20.6 mm); 3/8" (9.5 mm) x 7/8" (22.2 mm); 1/4" (6.3 mm) x 5/32" (4.0 mm); 1/4" (6.3 mm) x 3/16" (4.8 mm); 1/4" (6.3 mm) x 7/32" (5.6 mm); 1/4" (6.3 mm) x 1/4" (6.3 mm); 1/4" (6.3 mm) x 9/32" (7.1 mm); 1/4" (6.3 mm) x 5/16" (7.9 mm); 1/4" (6.3 mm) x 11/32" (8.7 mm); 1/4" (6.3 mm) x 3/8" (9.5 mm); 1/4" (6.3 mm) x 7/16" (11.1 mm); 1/4" (6.3 mm) x 1/2" (12.7 mm); CrV 50BV30: 1/2" (12.7 mm): 17, 19, 21, 23 mm; CrV 50BV30: 3/8" (9.5 mm): E8, E10, E11, E12, E14, E16, E18, E20; CrV 50BV30: 1/2" (12.7 mm): (127, 254 mm); 3/8" (9.5 mm): (76, 152.4 mm); 1/4" (6.3 mm): (50.8 mm); CrV 50BV30: 1/2" (12.7 mm); 3/8" (9.5 mm); 1/4" (6.3 mm); CrV 50BV30: 3/8" (9.5 mm): 16, 21 mm; CrV 50BV30: 1/2" (12.7 mm); (255 mm); 3/8" (9.5 mm): (200 mm); 1/4" (6.3 mm) x 1/4" (6.3 mm) x 1/4" (6.3 mm); CrV 6140: 1/4" (6.3 mm): (150 mm); CrV 50BV30: 1/4" (6.3 mm) x 1/4" (6.3 mm); CrV 6140: 1/4" (6.3 mm): T10, T15, T20, T25, T27, T30, T40 (L=25 mm); AISI S2: 3/8" (9.5 mm): 5.5, 6.5 mm (L=50 mm); AISI S2 / CrV 6150: 3/8" (9.5 mm): PH1, PH2 (L=50 mm); AISI S2 / CrV 6150: 3/8" (9.5 mm): PZ1, PZ2 (L=50 mm); AISI S2 / CrV 6150: 3/8" (9.5 mm): T20, T30, T40, T45, T50, T55, T60 (L=50 mm); AISI S2 / CrV 6150: 3/8" (9.5 mm): 3, 4, 5, 6 mm (L=50 mm); AISI S2 / CrV 6150: 8, 9, 10, 11, 12, 13, 14, 17, 18, 19 mm; CrV

| YATO    | 1/2" (12.7 mm) | 3/8" (9.5 mm) | 1/4" (6.3 mm) | 2 |
|---------|----------------|---------------|---------------|---|
| YT-3880 |                |               |               |   |



GB Tool set  
D Sechskant-Steckschlüssel-Satz  
PL Zestaw narzędziowy  
RUS Набор инструмента

CZ Sada nástrčných klíčů a ráčny  
H Dugókulcs készlet racsnis hajtókarral  
RO Roturusa chei tubulare cu antrenor  
F Coffret d'outillage

I Set di utensili  
E Juego de herramientas  
CN 套筒扳手组套

|                |              |               |
|----------------|--------------|---------------|
| 1/2"<br>12.5mm | 3/8"<br>10mm | 1/4"<br>6.3mm |
| CrV<br>50BV30  | CrV<br>6150  | CrV<br>6140   |
| S2             | 72T          | AS-DRIVE      |

2



128  
PCS

BMC & COLOR SLEEVE  
XI. SIZE



1/2" (12.7 mm): 14, 15, 16, 17, 18, 19, 20, 21, 22, 24 mm (L=38 mm); 27, 30, 32 mm (L=42 mm), 3/8" (9.5 mm): 10, 11, 12, 13, 14, 15, 16 mm (L=28 mm); 17, 18 mm (L=30 mm), 1/4" (6.3 mm): 6, 7, 8, 9, 10, 11, 12, 13 mm (L=25 mm); CrV 50BV30: 1/2" (12.7 mm): 17, 18, 19, 22 mm (L=76 mm), 3/8" (9.5 mm): 8, 10, 12, 13, 14, 15 mm (L=63 mm), 1/4" (6.3 mm): 6, 7, 8, 10, 12, 13 mm (L=50 mm); CrV 50BV30: 1/2" (12.7 mm): 17, 19, 21, 22 mm; CrV 50BV30: 3/8" (9.5 mm): E8, E10, E11, E12, E14, E16; CrV 50BV30: 1/2" (12.7 mm): (127, 254 mm), 3/8" (9.5 mm): (152.4, 254 mm), 1/4" (6.3 mm): (50.8, 101.6 mm); CrV 50BV30: 3/8" (9.5 mm) (F) x 1/2" (12.7 mm) (M); CrV 50BV30: 1/2" (12.7 mm), 3/8" (9.5 mm), 1/4" (6.3 mm); CrV 50BV30: 1/2" (12.7 mm): 16, 21 mm; CrV 50BV30: 3/8" (9.5 mm): (198 mm), 1/4" (6.3 mm): (152.4 mm); CrV 50BV30: 1/2" (12.7 mm): (255 mm), 3/8" (9.5 mm): (200 mm), 1/4" (6.3 mm): (155 mm); 72T; CrV 6140: 1/4" (6.3 mm): (150 mm); CrV 50BV30: 1/2" (12.7 mm): (250 mm); CrV 50BV30: 3/8" (9.5 mm) x 5/16" (7.9 mm); CrV 6140: 1/2" (12.7 mm) x 3/8" (9.5 mm), 3/8" (9.5 mm) x 1/4" (6.3 mm); CrV 50BV30: 1/4" (6.3 mm) x 1/4" (6.3 mm); CrV 6140: 3/8" (9.5 mm): 5.5, 6.5 mm (L=70 mm); AISI S2: 3/8" (9.5 mm): PH1, PH2, PH3 (L=70 mm); AISI S2: 3/8" (9.5 mm): T20, T30, T40, T45, T50, T55 (L=70 mm); AISI S2: 3/8" (9.5 mm): 6, 7, 8, 10, 12 mm (L=70 mm); AISI S2: 1/4" (6.3 mm): PZ1, PZ2 (L=25 mm); AISI S2: 1/4" (6.3 mm): T8, T10 (L=25 mm); AISI S2: 1/4" (6.3 mm): 4.0, 5.5, 6.5 mm (L=37 mm); AISI S2 / CrV 6150: 1/4" (6.3 mm): PH1, PH2 (L=37 mm); AISI S2 / CrV 6150: 1/4" (6.3 mm): T8, T10, T15, T20, T25, T30, T40 (L=37 mm); AISI S2 / CrV 6150: 1/4" (6.3 mm): 3, 4, 5, 6 mm (L=37 mm); AISI S2 / CrV 6150: 8, 10, 12, 13, 14, 15, 16, 17, 18, 19 mm; CrV: 1.5, 2, 2.5 mm; CrV 6150

| YATO    | 1/2" (12.7 mm) | 3/8" (9.5 mm) | 1/4" (6.3 mm) | 2 |
|---------|----------------|---------------|---------------|---|
| YT-3887 |                |               |               |   |



129  
PCS

CrV  
55

SVCM  
55

BMC & COLOR SLEEVE  
XXL SIZE



1/2" (12.7 mm): 12, 13, 14, 15, 16, 17, 18, 19, 20, 21, 22, 24 mm (L=38 mm); 27, 30, 32 mm (L=42 mm), 3/8" (9.5 mm): 10, 11, 12, 13, 14, 15, 16 mm (L=28 mm); 17, 18, 19 mm (L=30 mm), 1/4" (6.3 mm): 4, 4.5, 5, 5.5, 6, 7, 8, 9, 10, 11, 12, 13, 14 mm (L=25 mm); CrV 50BV30: 1/2" (12.7 mm): 10, 12, 13, 14, 17, 19 mm (L=76 mm), 1/4" (6.3 mm): 4, 5, 6, 7, 8, 9 mm (L=50 mm); CrV 50BV30: 1/2" (12.7 mm): 17, 19, 21, 23 mm; CrV 50BV30: 3/8" (9.5 mm): E8, E10, E11, E12, E14, E16, E18, E20; CrV 50BV30: 1/2" (12.7 mm): (127, 254 mm), 3/8" (9.5 mm): (76, 152.4 mm), 1/4" (6.3 mm): (50.8 mm); CrV 50BV30: 1/2" (12.7 mm), 3/8" (9.5 mm), 1/4" (6.3 mm); CrV 50BV30: 3/8" (9.5 mm): 16, 21 mm; CrV 50BV30: 1/2" (12.7 mm): (255 mm), 3/8" (9.5 mm): (200 mm), 1/4" (6.3 mm): (155 mm); 72T; CrV 6140: 1/4" (6.3 mm): (150 mm); CrV 50BV30: 3/8" (9.5 mm): 4.0, 5.5, 6.5 mm (L=50 mm); AISI S2 / CrV 6150: 3/8" (9.5 mm): PH1, PH2, PH3 (L=50 mm); AISI S2 / CrV 6150: 3/8" (9.5 mm): PZ1, PZ2, PZ3 (L=50 mm); AISI S2 / CrV 6150: 1/2" (12.7 mm): 8, 10, 11, 12, 13, 14, 15 mm; AISI S2 / CrV 6150: 3/8" (9.5 mm): 3, 4, 5, 6, 8, 10 mm (L=50 mm); AISI S2 / CrV 6150: 8, 10, 11, 12, 13, 14, 15, 16, 17, 18, 19, 22 mm; CrV: 3x75, 4x100, 6.5x150, PH1x75, PH2x100, PH3x150 mm; SVCM55: 180 mm; CrV 55: 160 mm; CrV 55: 160 mm; CrV 55: 1.5, 2, 2.5, 3, 4, 5, 6, 7, 8, 10 mm; CrV 6150

| YATO    | 1/2" (12.7 mm) | 3/8" (9.5 mm) | 1/4" (6.3 mm) | 2 |
|---------|----------------|---------------|---------------|---|
| YT-3888 |                |               |               |   |



GB Tool set  
 D Sechskant-Steckschlüssel-Satz  
 PL Zestaw narzędziowy  
 RUS Набор инструмента

CZ Sada nástrčných klíčů a ráčny  
 H Dugókulcs készlet racsnis hajtókarral  
 RO Rotrusa chei tubulare cu antrenor  
 F Coffret d'outillage

I Set di utensili  
 E Juego de herramientas  
 CN 套筒扳手组套

|                |              |               |               |             |
|----------------|--------------|---------------|---------------|-------------|
| 1/2"<br>12.5mm | 3/8"<br>10mm | 1/4"<br>6.3mm | CrV<br>50BV30 | CrV<br>6150 |
| CrV<br>6140    | S2           | 72T           | AS-DRIVE      |             |



**150**  
PCS

METRIC  
& S.A.E.

BMC & COLOR  
SLEEVE  
XXL SIZE



1/2" (12.7 mm): 20, 21, 22, 24 mm (L=38 mm); 27, 30, 32 mm (L=42 mm); 3/8" (9.5 mm): 9, 10, 11, 12, 13, 14, 15, 16 mm (L=28 mm); 17, 18, 19 mm (L=30 mm); 1/4" (6.3 mm): 4, 5, 6, 7, 8, 9, 10, 11, 12, 13 mm (L=25 mm); CrV 50BV30: 1/2" (12.7 mm): 10, 12, 13, 14, 17, 19 mm (L=76 mm); 3/8" (9.5 mm): 10, 11, 12, 13, 14, 15 mm (L=63 mm); 1/4" (6.3 mm): 4, 5, 6, 7, 8, 9 mm (L=50 mm); CrV 50BV30: 1/2" (12.7 mm) x 15/16" (23.8 mm); 1/2" (12.7 mm) x 1" (25.4 mm); 1/2" (12.7 mm) x 1-1/16" (27.0 mm); 1/2" (12.7 mm) x 1-1/4" (31.8 mm); 3/8" (9.5 mm) x 3/8" (9.5 mm); 3/8" (9.5 mm) x 7/16" (11.1 mm); 3/8" (9.5 mm) x 1/2" (12.7 mm); 3/8" (9.5 mm) x 9/16" (14.3 mm); 3/8" (9.5 mm) x 5/8" (15.9 mm); 3/8" (9.5 mm) x 11/16" (17.5 mm); 3/8" (9.5 mm) x 3/4" (19.0 mm); 3/8" (9.5 mm) x 13/16" (20.6 mm); 3/8" (9.5 mm) x 7/8" (22.2 mm); 1/4" (6.3 mm) x 5/32" (4.0 mm); 1/4" (6.3 mm) x 3/16" (4.8 mm); 1/4" (6.3 mm) x 7/32" (5.6 mm); 1/4" (6.3 mm) x 1/4" (6.3 mm); 1/4" (6.3 mm) x 9/32" (7.1 mm); 1/4" (6.3 mm) x 5/16" (7.9 mm); 1/4" (6.3 mm) x 11/32" (8.7 mm); 1/4" (6.3 mm) x 3/8" (9.5 mm); 1/4" (6.3 mm) x 7/16" (11.1 mm); 1/4" (6.3 mm) x 1/2" (12.7 mm); CrV 50BV30: 1/2" (12.7 mm): 17, 19, 21, 23 mm; CrV 50BV30: 3/8" (9.5 mm): E8, E10, E11, E12, E14, E16, E18, E20; CrV 50BV30: 1/2" (12.7 mm): (127, 254 mm); 3/8" (9.5 mm): (76, 152.4 mm); 1/4" (6.3 mm): (50.8 mm); CrV 50BV30: 1/2" (12.7 mm); 3/8" (9.5 mm); 1/4" (6.3 mm); CrV 50BV30: 3/8" (9.5 mm): 16, 21 mm; CrV 50BV30: 1/2" (12.7 mm): (255 mm); 3/8" (9.5 mm): (200 mm); 1/4" (6.3 mm): (155 mm); 72T: CrV 6140: 1/2" (12.7 mm): (150 mm); CrV 50BV30: 1/4" (6.3 mm) x 1/4" (6.3 mm); CrV 6140: 1/4" (6.3 mm): T10, T15, T20, T25, T27, T30, T40 (L=25 mm); AISI S2: 3/8" (9.5 mm): 4, 5, 5, 6, 5 mm (L=50 mm); AISI S2 / CrV 6150: PH1, PH2, PH3 (L=50 mm); AISI S2 / CrV 6150: 3/8" (9.5 mm): PZ1, PZ2, PZ3 (L=50 mm); AISI S2 / CrV 6150: 3/8" (9.5 mm): T20, T30, T40, T45, T50, T55, T60 (L=50 mm); AISI S2 / CrV 6150: 3/8" (9.5 mm): 3, 4, 5, 6, 8, 10 mm (L=50 mm); AISI S2 / CrV 6150: 8, 9, 10, 11, 12, 13, 14, 15, 16, 17, 18, 19 mm; CrV: 8x10, 12x13, 17x19 mm; 1.5, 2, 2.5, 3, 4, 5, 6, 7, 8, 10 mm; CrV 6150

|             |                |               |               |   |
|-------------|----------------|---------------|---------------|---|
| <b>YATO</b> | ○              | ○             | ○             | 📦 |
| YT-3881     | 1/2" (12.7 mm) | 3/8" (9.5 mm) | 1/4" (6.3 mm) | 2 |



**173**  
PCS

BMC & COLOR  
SLEEVE  
XL SIZE



1/2" (12.7 mm): 10, 11, 12, 13, 14, 15, 16, 17, 18, 19, 20, 21, 22, 23, 24 mm (L=38 mm); 27, 30, 32 mm (L=42 mm); 3/8" (9.5 mm): 10, 11, 12, 13, 14, 15, 16 mm (L=28 mm); 17, 18, 19 mm (L=30 mm); 1/4" (6.3 mm): 4, 4.5, 5, 5.5, 6, 7, 8, 9, 10, 11, 12, 13, 14 mm (L=25 mm); CrV 50BV30: 1/2" (12.7 mm): 16, 17, 18, 19, 22 mm (L=76 mm); 3/8" (9.5 mm): 10, 11, 12, 13, 14, 15 mm (L=63 mm); 1/4" (6.3 mm): 4, 5, 6, 7, 8, 9, 10 mm (L=50 mm); CrV 50BV30: 1/2" (12.7 mm): E18, E20, E24, 3/8" (9.5 mm): E10, E11, E12, E14, E16, 1/4" (6.3 mm): E4, E5, E6, E7, E8; CrV 50BV30: 1/2" (12.7 mm): (127, 254 mm); 3/8" (9.5 mm): (152.4 mm); 1/4" (6.3 mm): (50.8, 101.6 mm); CrV 50BV30: 3/8" (9.5 mm) (F) x 1/2" (12.7 mm) (M); CrV 50BV30: 1/2" (12.7 mm); 3/8" (9.5 mm); 1/4" (6.3 mm); CrV 50BV30: 1/2" (12.7 mm): 16, 21 mm; 3/8" (9.5 mm): 18 mm; CrV 50BV30: 1/4" (6.3 mm): (152.4 mm); CrV 50BV30: 1/2" (12.7 mm): (255 mm); 3/8" (9.5 mm): (200 mm); 1/4" (6.3 mm): (155 mm); 72T: CrV 6140: 1/4" (6.3 mm): (150 mm); CrV 50BV30: 1/2" (12.7 mm) x 5/16" (7.9 mm); 3/8" (9.5 mm) x 5/16" (7.9 mm); CrV 6140: 1/4" (6.3 mm) x 1/4" (6.3 mm); CrV 6140: 5/16" (7.9 mm); 7, 8, 10, 12, 14 mm (L=30 mm); AISI S2: 5/16" (7.9 mm): PH3, PH4 (L=30 mm); AISI S2: 5/16" (7.9 mm): PZ3, PZ4 (L=30 mm); AISI S2: 5/16" (7.9 mm): T40, T45, T50, T55, T60, T70 (L=30 mm); AISI S2: 5/16" (7.9 mm): T40, T45, T50, T55, T60, T70 (L=30 mm); AISI S2: 5/16" (7.9 mm): 7, 8, 10, 12, 14 mm (L=30 mm); AISI S2: 1/4" (6.3 mm): T5, T6, T7 (L=25 mm); AISI S2: 1/4" (6.3 mm): T7, T10, T15, T20, T25, T27, T30, T40, T45 (L=25 mm); AISI S2: 1/4" (6.3 mm): M5, M6, M8 (L=25 mm); AISI S2: 1/4" (6.3 mm): RM5, RM6, RM7, RM8, RM9 (L=25 mm); AISI S2: 1/4" (6.3 mm): 4, 5, 5, 6, 5, 7 mm (L=37 mm); AISI S2 / CrV 6150: 1/4" (6.3 mm): PH0, PH1, PH2 (L=37 mm); AISI S2 / CrV 6150: 1/4" (6.3 mm): PZ0, PZ1, PZ2 (L=37 mm); AISI S2 / CrV 6150: 1/4" (6.3 mm): T8, T9, T10, T15, T20, T25, T27, T30 (L=37 mm); AISI S2 / CrV 6150: 1/4" (6.3 mm): T8, T9, T10, T15, T20, T25, T27, T30 (L=37 mm); AISI S2 / CrV 6150: 1/4" (6.3 mm): 3, 4, 5, 6 mm (L=37 mm); AISI S2 / CrV 6150: 1.25, 1.5, 2, 2.5, 3, 4, 5 mm; CrV 6150

|             |                |               |               |   |
|-------------|----------------|---------------|---------------|---|
| <b>YATO</b> | ○              | ○             | ○             | 📦 |
| YT-3893     | 1/2" (12.7 mm) | 3/8" (9.5 mm) | 1/4" (6.3 mm) | 2 |



GB Tool set  
D Sechskant-Steckschlüssel-Satz  
PL Zestaw narzędziowy  
RUS Набор инструмента

CZ Sada nástrčných klíčů a ráčny  
H Dugókulcs készlet racsni hajtókarral  
RO Rotirusa chei tubulare cu antrenor  
F Coffret d'outillage

I Set di utensili  
E Juego de herramientas  
CN 套筒扳手组套

|                |              |               |               |             |
|----------------|--------------|---------------|---------------|-------------|
| 1/2"<br>12.5mm | 3/8"<br>10mm | 1/4"<br>6.3mm | CrV<br>50BV30 | CrV<br>6150 |
| CrV<br>6140    | S2           | 72T           | AS-DRIVE      | MAGNETIC    |

2

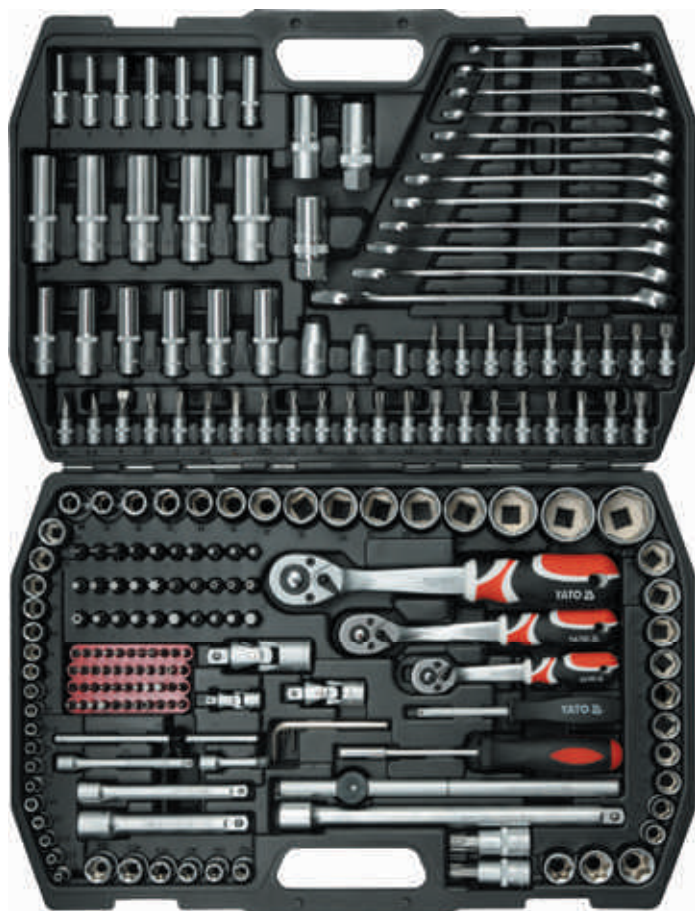

216  
PCS

BMC & COLOR  
SLEEVE  
XXL SIZE



1/2" (12.7 mm): 10, 11, 12, 13, 14, 15, 17, 19, 20, 21, 22, 24 mm (L=38 mm); 27, 30, 32 mm (L=42 mm); 3/8" (9.5 mm): 10, 11, 12, 13, 14, 15, 16 mm (L=28 mm); 17, 18, 19 mm (L=30 mm); 1/4" (6.3 mm): 4, 4.5, 5, 5.5, 6, 7, 8, 9, 10, 11, 12, 13, 14 mm (L=25 mm); CrV 50BV30: 1/2" (12.7 mm): 16, 17, 18, 19, 22 mm (L=76 mm); 3/8" (9.5 mm): 10, 11, 12, 13, 14, 15 mm (L=63 mm); 1/4" (6.3 mm): 4, 5, 6, 7, 8, 9, 10 mm (L=50 mm); CrV 50BV30: 1/2" (12.7 mm): E20, E22, E24, 3/8" (9.5 mm): E10, E11, E12, E14, E16, E18, 1/4" (6.3 mm): E4, E5, E6, E7, E8; CrV 50BV30: 1/2" (12.7 mm): (127, 254 mm); 3/8" (9.5 mm): (125 mm); 1/4" (6.3 mm): (50.8, 101.6 mm); CrV 50BV30: 1/2" (12.7 mm); 3/8" (9.5 mm); 1/4" (6.3 mm); CrV 50BV30: 1/2" (12.7 mm): 16, 21 mm; 3/8" (9.5 mm): 18 mm; CrV 50BV30: 1/2" (12.7 mm): (255 mm); 1/4" (6.3 mm): (152.4 mm); CrV 50BV30: 1/2" (12.7 mm): (255 mm); 3/8" (9.5 mm): (200 mm); 1/4" (6.3 mm): (155 mm); 72T; CrV 6140: 1/4" (6.3 mm): (150 mm); CrV 50BV30: 1/4" (6.3 mm); (200 mm); CrV 6140: 1/2" (12.7 mm) x 5/16" (7.9 mm); 3/8" (9.5 mm) x 5/16" (7.9 mm); CrV 6140: 1/4" (6.3 mm) x 1/4" (6.3 mm); CrV 6140: 5/16" (7.9 mm); 6, 6.5, 8 mm (L=30 mm); AISI S2: 5/16" (7.9 mm); PH3, PH4 (L=30 mm); AISI S2: 5/16" (7.9 mm); PZ3, PZ4 (L=30 mm); AISI S2: 5/16" (7.9 mm); T25, T27, T30, T35, 2xT40, T45, T50 (L=30 mm); AISI S2: 5/16" (7.9 mm); T27, T30, T35, T40, T45, T50 (L=30 mm); AISI S2: 5/16" (7.9 mm); 5.5, 6, 6.5, 7, 8 mm (L=30 mm); AISI S2: 5/16" (7.9 mm); M5, M6, M8, M10 (L=30 mm); AISI S2: 1/4" (6.3 mm); 4, 4.5, 5, 6 mm (L=25 mm); AISI S2: 1/4" (6.3 mm); PH1, PH2 (L=25 mm); AISI S2: 1/4" (6.3 mm); PZ1, PZ2 (L=25 mm); AISI S2: 1/4" (6.3 mm); T8, T10, T15, T20, T25 (L=25 mm); AISI S2: 1/4" (6.3 mm); T8, 2xT10, 2xT15, 2xT25, T40 (L=25 mm); AISI S2: 1/4" (6.3 mm); 3, 4, 5, 6 mm (L=25 mm); AISI S2: 1/4" (6.3 mm); M5, M6, M8 (L=25 mm); AISI S2: 1/4" (6.3 mm); S1, S2 (L=25 mm); AISI S2: 1/4" (6.3 mm); 1, 2, 3 mm (L=25 mm); AISI S2: 1/4" (6.3 mm); 6, 8, 10 mm (L=25 mm); AISI S2: 1/4" (6.3 mm); 4, 6, 8 mm (L=25 mm); AISI S2: 1/2" (12.7 mm); T55, T60 (L=50 mm); AISI S2 / CrV 6150: 1/4" (6.3 mm); 6, 6.5, 8 mm (L=37 mm); AISI S2 / CrV 6150: 1/4" (6.3 mm); PH3, PH4 (L=37 mm); AISI S2 / CrV 6150: 1/4" (6.3 mm); PZ3, PZ4 (L=37 mm); AISI S2 / CrV 6150: 1/4" (6.3 mm); T25, T27, T30, T35, 2xT40, T45, T50 (L=37 mm); AISI S2 / CrV 6150: 1/4" (6.3 mm); T27, T30, T35, T40, T45, T50 (L=37 mm); AISI S2 / CrV 6150: 1/4" (6.3 mm); 5.5, 6, 6.5, 7, 8 mm (L=37 mm); AISI S2 / CrV 6150: 1/4" (6.3 mm); M5, M6, M8, M10 (L=37 mm); AISI S2 / CrV 6150: 8, 10, 11, 12, 13, 14, 15, 16, 17, 18, 19, 22 mm; CrV: 1.27, 1.5, 2, 2.5, 3, 4, 5 mm; CrV 6150

|         |                |               |               |   |
|---------|----------------|---------------|---------------|---|
| YATO    | 1/2"           | 3/8"          | 1/4"          | 2 |
| YT-3884 | 1/2" (12.7 mm) | 3/8" (9.5 mm) | 1/4" (6.3 mm) | 2 |



224  
PCS

METRIC  
& S.A.E.

CrV  
55

BMC & COLOR  
SLEEVE  
XXXL SIZE



1/2" (12.7 mm): 10, 13, 15, 16, 17, 18, 19, 20, 21, 22, 23, 24 mm (L=38 mm); 27, 30, 32 mm (L=42 mm); 3/8" (9.5 mm): 10, 11, 12, 13, 14, 15, 16 mm (L=28 mm); 17, 18, 19 mm (L=30 mm); 1/4" (6.3 mm): 3.5, 4, 4.5, 5, 5.5, 6, 7, 8, 9, 10, 11, 12, 13, 14 mm (L=25 mm); CrV 50BV30: 1/2" (12.7 mm): 10, 11, 12, 13, 14, 15, 17, 19, 21 mm (L=76 mm); 3/8" (9.5 mm): 6, 7, 8, 9, 10 mm (L=63 mm); CrV 50BV30: 1/2" (12.7 mm) x 7/16" (11.1 mm); 1/2" (12.7 mm) x 1/2" (12.7 mm); 1/2" (12.7 mm) x 9/16" (14.3 mm); 1/2" (12.7 mm) x 5/8" (15.9 mm); 1/2" (12.7 mm) x 11/16" (17.5 mm); 1/2" (12.7 mm) x 3/4" (19.0 mm); 1/2" (12.7 mm) x 13/16" (20.6 mm); 1/2" (12.7 mm) x 7/8" (22.2 mm); 1/4" (6.3 mm) x 1/4" (6.3 mm); 1/4" (6.3 mm) x 9/32" (7.1 mm); 1/4" (6.3 mm) x 5/16" (7.9 mm); 1/4" (6.3 mm) x 11/32" (8.7 mm); 1/4" (6.3 mm) x 3/8" (9.5 mm); CrV 50BV30: 1/2" (12.7 mm): 17, 19, 21 mm; CrV 50BV30: 1/2" (12.7 mm): E16, E18, E20, E22, E24, 3/8" (9.5 mm): E10, E11, E12, E14, 1/4" (6.3 mm): E4, E5, E6, E7, E8; CrV 50BV30: 1/2" (12.7 mm): (127, 254 mm); 3/8" (9.5 mm): (76, 254 mm); 1/4" (6.3 mm): (50.8, 101.6 mm); CrV 50BV30: 3/8" (9.5 mm) (F) x 1/2" (12.7 mm) (M); 1/2" (12.7 mm) (F) x 3/8" (9.5 mm) (M); CrV 50BV30: 1/2" (12.7 mm); 3/8" (9.5 mm); 1/4" (6.3 mm); CrV 50BV30: 1/2" (12.7 mm): 16, 21 mm; 3/8" (9.5 mm); 18 mm; CrV 50BV30: 1/4" (6.3 mm); (152.4 mm); CrV 50BV30: 1/2" (12.7 mm): (255 mm); 3/8" (9.5 mm): (200 mm); 1/4" (6.3 mm): (155 mm); 72T; CrV 6140: 1/4" (6.3 mm); (150 mm); CrV 50BV30: 1/4" (6.3 mm); (200 mm); CrV 6140: 1/2" (12.7 mm) x 5/16" (7.9 mm); 3/8" (9.5 mm) x 5/16" (7.9 mm); 3/8" (9.5 mm) x 1/4" (6.3 mm); CrV 6140: 1/4" (6.3 mm) x 1/4" (6.3 mm); CrV 6140: 1/4" (6.3 mm) x 3/8" (9.5 mm) (L=50 mm); 1/4" (6.3 mm) x 1/4" (6.3 mm) (L=50 mm); 1/4" (6.3 mm) x 1/4" (6.3 mm) (L=25 mm); CrV 6140: 1/4" (6.3 mm) (L=60 mm); 5/16" (7.9 mm); T20, T25, T27, T30, T40, T45, T50, T55 (L=75 mm); AISI S2: 5/16" (7.9 mm); 8, 10 mm (L=30 mm); AISI S2: 5/16" (7.9 mm); PH3, PH4 (L=30 mm); AISI S2: 5/16" (7.9 mm); PZ3, PZ4 (L=30 mm); AISI S2: 5/16" (7.9 mm); T40, T45, T50, T55, T60, T70 (L=30 mm); AISI S2: 5/16" (7.9 mm); T40, T45, T50, T55, T60, T70 (L=30 mm); AISI S2: 1/4" (6.3 mm); 3, 4, 5, 6.5, 7, 8, 9 mm (L=25 mm); AISI S2: 1/4" (6.3 mm); PH0, PH1, PH2, PH3 (L=25 mm); AISI S2: 1/4" (6.3 mm); PZ0, PZ1, PZ2, PZ3 (L=25 mm); AISI S2: 1/4" (6.3 mm); T8, T9, T10, T15, T20, T25, T27, T30 (L=25 mm); AISI S2: 1/4" (6.3 mm); T8, T9, T10, T15, T20, T25, T27, T30 (L=25 mm); AISI S2: 1/4" (6.3 mm); 3, 4, 5, 6, 7, 8 mm (L=25 mm); AISI S2: 1/4" (6.3 mm); 3, 4, 5, 6, 7, 8 mm (L=25 mm); AISI S2: 1/4" (6.3 mm); 1, 2, 3, 4 mm (L=25 mm); AISI S2: 1/4" (6.3 mm); 6, 8, 10 mm (L=25 mm); AISI S2: 1/4" (6.3 mm); 4, 6, 8, 10 mm (L=25 mm); AISI S2: 1/4" (6.3 mm); 8, 9, 10, 11, 12, 13, 14, 15, 17, 19, 22 mm; CrV: 6.5x38 mm, PH2x38 mm; SVCM55: 180 mm; CrV 55: 250 mm; CrV: 2, 2.5, 3, 4, 5, 6, 7, 8, 10, 12 mm; CrV 6150

|         |                |               |               |   |
|---------|----------------|---------------|---------------|---|
| YATO    | 1/2"           | 3/8"          | 1/4"          | 2 |
| YT-3894 | 1/2" (12.7 mm) | 3/8" (9.5 mm) | 1/4" (6.3 mm) | 2 |



- GB Torx socket
- D Torx-Steckschlüssel
- PL Nasadka Torx
- RUS Головка
- CZ Nástavec Torx
- H Hatszögű rátét Torx
- RO Cheie tubulară Torx
- F Douille Torx
- I Bullone Torx
- E Boquilla Torx
- CN 星型套筒

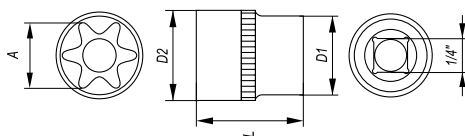

COLOR BOX



1/4" 6.3mm TORX CrV 50BV30

| YATO     | A (mm) | D1 (mm) | D2 (mm) | L (mm) | PCS packing |         |
|----------|--------|---------|---------|--------|-------------|---------|
| YT-05211 | E4     | 11.9    | 6.7     | 25     | 24          | 240/480 |
| YT-05212 | E5     | 11.9    | 7.2     | 25     | 24          | 240/480 |
| YT-05213 | E6     | 11.9    | 8.3     | 25     | 24          | 240/480 |
| YT-05214 | E7     | 11.9    | 9.4     | 25     | 24          | 240/480 |
| YT-05215 | E8     | 11.9    | 10.0    | 25     | 24          | 240/480 |

- GB Torx socket set
- D Torx-Steckschlüsselsatz
- PL Klucze nasadowe Torx
- RUS Набор головок
- CZ Nástrčné kľíče
- H Dugókulcs
- RO Trusa tubulară
- F Clés à tube
- I Chiavi a bussola bulloni Torx
- E Llaves de vaso
- CN 星型套筒组套



9 PCS TORX CrV 50BV30



- 1/4" (6.3 mm): E5, E6, E7, E8, 3/8" (9.5 mm): E10, E12, E14, E16;
- 1/4" (6.3 mm) (M) x 3/8" (9.5 mm) (F)

| YATO    |               |       |
|---------|---------------|-------|
| YT-0520 | 1/4" (6.3 mm) | 10/40 |

- GB Torx socket
- D Torx-Steckschlüssel
- PL Nasadka Torx
- RUS Головка
- CZ Nástavec Torx
- H Hatszögű rátét Torx
- RO Cheie tubulară Torx
- F Douille Torx
- I Bullone Torx
- E Boquilla Torx
- CN 星型套筒

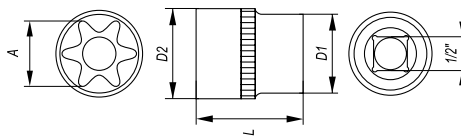

1/2" 12.5mm TORX CrV 50BV30

COLOR BOX



| YATO     | A (mm) | D1 (mm) | D2 (mm) | L (mm) | PCS packing |         |
|----------|--------|---------|---------|--------|-------------|---------|
| YT-05220 | E10    | 21.8    | 13.1    | 38     | 12          | 120/240 |
| YT-05221 | E11    | 21.8    | 13.9    | 38     | 12          | 120/240 |
| YT-05222 | E12    | 21.8    | 14.9    | 38     | 12          | 120/240 |
| YT-05223 | E14    | 21.8    | 16.3    | 38     | 12          | 120/240 |
| YT-05224 | E16    | 21.8    | 18.2    | 38     | 12          | 120/240 |

| YATO     | A (mm) | D1 (mm) | D2 (mm) | L (mm) | PCS packing |         |
|----------|--------|---------|---------|--------|-------------|---------|
| YT-05225 | E18    | 23.8    | 19.4    | 38     | 12          | 120/240 |
| YT-05226 | E20    | 21.8    | 23.9    | 38     | 12          | 120/240 |
| YT-05227 | E22    | 23.2    | 25.7    | 38     | 12          | 120/240 |
| YT-05228 | E24    | 23.8    | 27.8    | 38     | 12          | 60/120  |

- GB Torx socket set
- D Torx-Steckschlüsselsatz
- PL Klucze nasadowe Torx
- RUS Набор головок
- CZ Nástrčné kľíče
- H Dugókulcs
- RO Trusa tubulară
- F Clés à tube
- I Chiavi a bussola bulloni Torx
- E Llaves de vaso
- CN 星型套筒组套



9 PCS TORX CrV 50BV30

METAL CASE & COLOR SLEEVE



- 1/2" (12.7 mm): E10, E11, E12, E14, E16, E18, E20, E22, E24

| YATO    |                |    |
|---------|----------------|----|
| YT-0521 | 1/2" (12.7 mm) | 20 |

- GB Go-through socket set
- D Durchgangs-Knarrenkasten
- PL Zestaw nasadek przelotowych z grzechotką
- RUS Набор торцевых головок сквозных с трещоткой
- CZ Sada průchodných nástrčných kľíčů

- H Dugókulcs készlet, csavarszár átengedős
- RO Set chei tubulară cu crichet
- F Set de douilles à cliquet
- I Set chiavi a bussola con cricchetto

- E Juego de boquillas con orificio pasante, con carraca
- CN 套筒扳手组套

21 PCS 1/2" 12.5mm 1/4" 6.3mm

CrV 50BV30 CrV 6140 QUICK RELEASE SZYBKÓ-ZŁĄCZE

METRIC METRYCZNE IMPERIAL



- 10, 11, 12, 13, 14, 15, 16, 17, 18, 19 mm (L=32 mm);
- 3/8" (9.5 mm), 7/16" (11.1 mm), 1/2" (12.7 mm), 9/16" (14.3 mm),
- 5/8" (15.9 mm), 11/16" (17.5 mm), 3/4" (19.0 mm) (L=32 mm); CrV 50BV30;
- 178 mm; CrV 6140; 1/2" (12.7 mm), 1/4" (6.3 mm); CrV 6140;
- 17 mm (L=75 mm); CrV 50BV30

| YATO    |                |               |      |
|---------|----------------|---------------|------|
| YT-3865 | 1/2" (12.7 mm) | 1/4" (6.3 mm) | 3/12 |

BMC & COLOR SLEEVE





- GB Hexagonal socket
- D Sechskantenschlüssel
- PL Nasadka sześciokątna
- RUS Головка шестигранная
- CZ Šestihranný nástavec
- H Hatszögű rátét
- RO Cheie tubulară hexagonală
- F Douille 6 pans
- I Chiave a bussola esagonale
- E Boquilla hexagonal
- CN 六角套筒

- application: industry, car service stations and workshops
- for high loads
- drive locks
- surface finish: chromed, satin
- przeznaczenie: przemysł, serwisy i warsztaty
- do największych obciążeń
- zamki blokujące
- wykończenie powierzchni: chromowana, satynowa

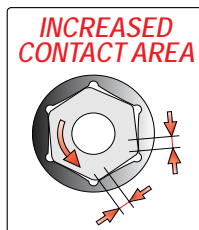
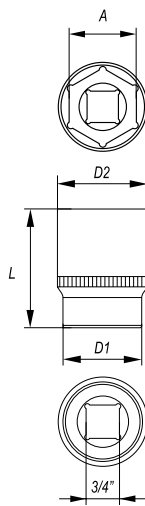

**3/4"**  
**19mm**

**DIN**  
**3121**

**CrV**  
**50BV30**

**AS-DRIVE**



| YATO    | ∅ A (mm) | D1 (mm) | D2 (mm) | L (mm) | PCS packing |    |
|---------|----------|---------|---------|--------|-------------|----|
| YT-1301 | 19       | 30      | 36      | 50     | 12          | 96 |
| YT-1302 | 21       | 32      | 36      | 50     | 12          | 96 |
| YT-1303 | 22       | 32      | 36      | 50     | 12          | 96 |
| YT-1304 | 23       | 34      | 36      | 50     | 12          | 96 |
| YT-1305 | 24       | 34      | 36      | 50     | 12          | 96 |
| YT-1306 | 25       | 36      | 36      | 50     | 12          | 96 |
| YT-1307 | 26       | 37      | 34      | 50     | 12          | 96 |
| YT-1308 | 27       | 38      | 34      | 50     | 12          | 96 |
| YT-1309 | 28       | 40      | 34      | 50     | 12          | 96 |
| YT-1310 | 29       | 40      | 35      | 50     | 12          | 96 |
| YT-1311 | 30       | 42      | 36      | 55     | 8           | 48 |
| YT-1312 | 32       | 44      | 37      | 55     | 8           | 48 |
| YT-1313 | 33       | 46      | 38      | 55     | 8           | 48 |

| YATO    | ∅ A (mm) | D1 (mm) | D2 (mm) | L (mm) | PCS packing |    |
|---------|----------|---------|---------|--------|-------------|----|
| YT-1314 | 34       | 47      | 38      | 55     | 8           | 48 |
| YT-1315 | 35       | 48      | 42      | 60     | 6           | 36 |
| YT-1316 | 36       | 50      | 42      | 60     | 6           | 36 |
| YT-1317 | 38       | 52      | 45      | 60     | 6           | 36 |
| YT-1318 | 41       | 56      | 45      | 65     | 4           | 32 |
| YT-1319 | 42       | 57      | 45      | 65     | 4           | 32 |
| YT-1320 | 43       | 58      | 45      | 65     | 4           | 32 |
| YT-1322 | 46       | 62      | 48      | 70     | 4           | 32 |
| YT-1323 | 48       | 64      | 48      | 70     | 4           | 24 |
| YT-1324 | 50       | 68      | 48      | 70     | 4           | 24 |
| YT-1326 | 52       | 70      | 48      | 70     | 4           | 20 |
| YT-1328 | 55       | 73      | 48      | 75     | 4           | 20 |
| YT-1330 | 60       | 80      | 48      | 80     | 4           | 20 |

- GB Extension bar
- D Verlängerung
- PL Przedłużka
- RUS Удлинитель для воротка
- CZ Prodlužovací přípravek
- H Toldalék
- RO Prelungitor
- F Rallonge
- I Prolunga
- E Tubo de prolongación
- CN 接杆

**3/4"**  
**19mm**

**DIN**  
**3121**

**CrV**  
**50BV30**

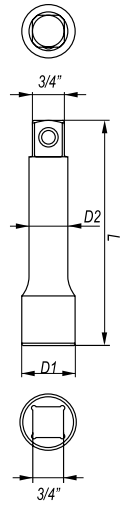

| YATO    | ∅              | D1 (mm) | D2 (mm) | L (mm) | PCS packing |    |
|---------|----------------|---------|---------|--------|-------------|----|
| YT-1340 | 3/4" (19.0 mm) | 36      | 22      | 100    | 6           | 36 |
| YT-1341 | 3/4" (19.0 mm) | 36      | 22      | 200    | 5           | 20 |
| YT-1342 | 3/4" (19.0 mm) | 36      | 22      | 400    | 5           | 10 |

- GB Adapter
- D Reduktion
- PL Redukcja
- RUS Переходник
- CZ Redukce
- H Redukció
- RO Reducție
- F Réduction
- I Riduttore
- E Reducción
- CN 转换头

**3/4"**  
**19mm**

**DIN**  
**3121**

**CrV**  
**50BV30**

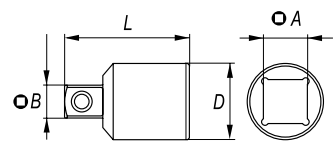

| YATO    | ∅ A            | ∅ B                    | D (mm) | L (mm) | PCS packing |    |
|---------|----------------|------------------------|--------|--------|-------------|----|
| YT-1355 | 3/4" (19.0 mm) | (F) 1/2" (12.7 mm) (M) | 36     | 53     | 12          | 48 |

- GB Universal joint
- D Kardangelen
- PL Przegub Cardana
- RUS Карданный шарнир
- CZ Kardanový kloub
- H Kardan csukló
- RO Articulație Cardanică
- F Cardan
- I Snodo cardanico
- E Articulación Cardan
- CN 万向接头

**3/4"**  
**19mm**

**DIN**  
**3121**

**CrV**  
**50BV30**

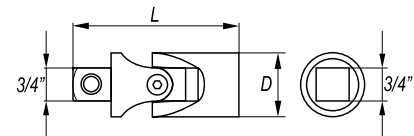

| YATO    | ∅              | D (mm) | L (mm) | PCS packing |    |
|---------|----------------|--------|--------|-------------|----|
| YT-1352 | 3/4" (19.0 mm) | 40     | 106    | 12          | 36 |

- GB Sliding T-bar
- D Handgriff mit Gleitstück
- PL Pokrętko typu „T”
- RUS Вороток Т-образный
- CZ Otočná račka typ „T”
- H „T” alakú hajtókar
- RO Mâner clupă tipul „T”
- E Mango tipo „T”
- F Barre type „T”
- I Manopola „T” scorrevole
- CN 滑杆

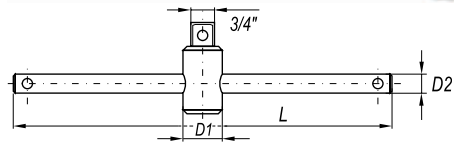

**3/4"**  
**19mm**

**DIN**  
**3121**

**CrV**  
**50BV30**



| YATO    | ∅              | D1 (mm) | D2 (mm) | L (mm) | PCS packing |    |
|---------|----------------|---------|---------|--------|-------------|----|
| YT-1350 | 3/4" (19.0 mm) | 37      | 20      | 500    | 5           | 10 |

- GB Flexible handle
- D Gelenkgriff
- PL Pokrętko lamane
- RUS Вороток шарнирный
- CZ Otočná lomená ráčka
- H Hajlított hajtókar
- RO Prelungitor cu prindere flexibilă
- F Barre pivotante
- I Manopola a snodo
- E Mango articulado
- CN 转向手柄

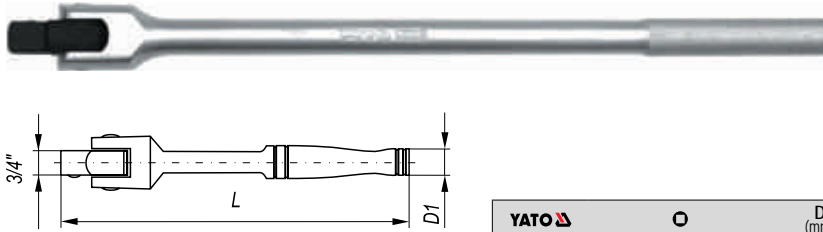

3/4" DIN CrV  
19mm 3121 50BV30



| YATO    | Ø              | D (mm) | L (mm) | PCS packing |    |
|---------|----------------|--------|--------|-------------|----|
| YT-1345 | 3/4" (19.0 mm) | 25     | 507    | 5           | 10 |

- GB L-type handle
- D Admutherschlüssel
- PL Pokrętko typu „L”
- RUS Вороток 1/2" тип „L”
- CZ Páka zahnutá
- H „L” alakú hajtókar
- RO Mâner clupă tipul „L”
- F Barre type „L”
- I Leva tipo „L”
- E Mango tipo „L”
- CN L型套筒扳手



3/4" DIN CrV  
19mm 3121 50BV30



| YATO    | Ø              | D (mm) | L (mm) | PCS packing |    |
|---------|----------------|--------|--------|-------------|----|
| YT-1347 | 3/4" (19.0 mm) | 25     | 385    | 5           | 10 |
| YT-1348 | 3/4" (19.0 mm) | 25     | 440    | 5           | 10 |

- GB Quick release ratchet handle
- D Hebelumschaltknarre
- PL Grzechotka
- RUS Трещотка
- CZ Řehtačka
- H Racsnis hajtókar
- RO Dispozitiv de prindere cu clichet
- F Clé à cliquet
- I Cricchetto bussola
- E Carraca
- CN 快速脱落棘轮扳手

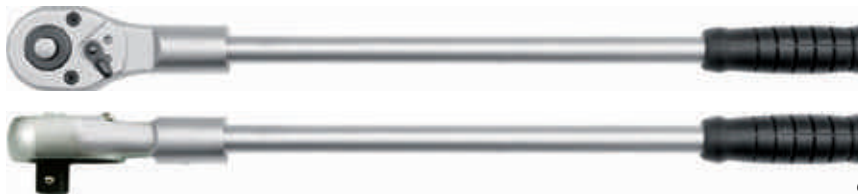

3/4" DIN 24T  
19mm 3122

CrV 6140  
QUICK RELEASE SZYBKO-ZŁĄCZE



| YATO    | Ø              | T  | L (mm) |    |
|---------|----------------|----|--------|----|
| YT-1360 | 3/4" (19.0 mm) | 24 | 625    | 10 |

- GB Socket set
- D Sechskant-Steckschlüssel-Satz
- PL Komplet nasadek z akcesoriami
- RUS Набор насадок
- CZ Sada nástrčných kličů a ráčny
- H Dugókulcs készlet racsnis hajtókarral

- RO Rotrușă chei tubulare cu antrenor
- F Clé à cliquet
- I Cricchetto bussola
- E Juego de boquillas con accesorios
- CN 套筒扳手套组



3/4" CrV CrV  
19mm 50BV30 6140

QUICK RELEASE SZYBKO-ZŁĄCZE 24T

AS-DRIVE



3/4" (19.0 mm): 30, 32, 34 (L=55 mm); 36, 38 (L=60 mm); 41 (L=65 mm); 46, 50 (L=70 mm); 55 (L=75 mm); 60 mm (L=80 mm); CrV 50BV30; 3/4" (19.0 mm); (L=500 mm); 24T; CrV 6140; 3/4" (19.0 mm); (L=500 mm); CrV 50BV30; 3/4" (19.0 mm); (L=100, 200 mm); CrV 50BV30; 3/4" (19.0 mm); (L=106 mm); CrV 50BV30

15 PCS

| YATO    | Ø              |   |
|---------|----------------|---|
| YT-1334 | 3/4" (19.0 mm) | 1 |

3/4" (19.0 mm): 19, 21, 22, 24 mm (L=50 mm); 26, 27, 28 mm (L=52 mm); 30, 32 mm (L=53 mm); 33, 34 mm (L=56 mm); 36 mm (L=58 mm); 38 mm (L=60 mm); 41 mm (L=64 mm); 46 mm (L=68 mm); 50 mm (L=72mm); CrV 50BV30; 3/4" (19.0 mm) x 620 mm; CrV 6140; 3/4" (19.0 mm); (L=500 mm); CrV 50BV30; 3/4" (19.0 mm) x 100 mm; 3/4" (19.0 mm) x 200 mm; CrV 50BV30

20 PCS

| YATO    | Ø              |   |
|---------|----------------|---|
| YT-1335 | 3/4" (19.0 mm) | 1 |



- GB Star bit sockets  
D Aufsteckschlüssel  
PL Klucze trzpieniowe  
RUS Набор головок-вставок  
CZ Čepové klíče  
H Csapkulcs
- RO Chei cu cozi  
F Douille tournevis  
I Chiavi a bussola  
E Llaves de mandril  
CN 星型旋具套筒



SLIDING CARD

|          |           |
|----------|-----------|
| 1/4"     | AISI S2   |
| 6.3mm    |           |
| DIN 3120 | HRC 58-62 |

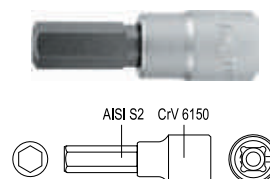
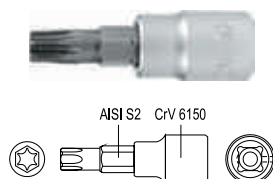

| YATO    | Ø             | ☆   | L (mm) | torque / moment obrotowy max. (Nm) | ☐      |
|---------|---------------|-----|--------|------------------------------------|--------|
| YT-7660 | 1/4" (6.3 mm) | T8  | 37     | 3.9                                | 10/100 |
| YT-7661 | 1/4" (6.3 mm) | T10 | 37     | 5.9                                | 10/100 |
| YT-7662 | 1/4" (6.3 mm) | T15 | 37     | 9.8                                | 10/100 |
| YT-7663 | 1/4" (6.3 mm) | T20 | 37     | 18.6                               | 10/100 |
| YT-7664 | 1/4" (6.3 mm) | T25 | 37     | 26.5                               | 10/100 |
| YT-7665 | 1/4" (6.3 mm) | T30 | 37     | 42.9                               | 10/100 |
| YT-7666 | 1/4" (6.3 mm) | T40 | 37     | 75.8                               | 10/100 |

| YATO    | Ø             | ⬡ | L (mm) | torque / moment obrotowy max. (Nm) | ☐      |
|---------|---------------|---|--------|------------------------------------|--------|
| YT-7667 | 1/4" (6.3 mm) | 3 | 37     | 14.7                               | 10/100 |
| YT-7668 | 1/4" (6.3 mm) | 4 | 37     | 26.5                               | 10/100 |
| YT-7669 | 1/4" (6.3 mm) | 5 | 37     | 53.8                               | 10/100 |
| YT-7670 | 1/4" (6.3 mm) | 6 | 37     | 88.6                               | 10/100 |
| YT-7671 | 1/4" (6.3 mm) | 7 | 37     | 120.6                              | 10/100 |
| YT-7672 | 1/4" (6.3 mm) | 8 | 37     | 170.2                              | 10/100 |

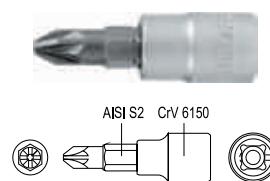
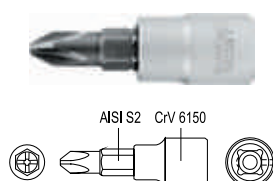

| YATO    | Ø             | ⊕   | L (mm) | torque / moment obrotowy max. (Nm) | ☐      |
|---------|---------------|-----|--------|------------------------------------|--------|
| YT-7673 | 1/4" (6.3 mm) | PH1 | 37     | 7.6                                | 10/100 |
| YT-7674 | 1/4" (6.3 mm) | PH2 | 37     | 21.6                               | 10/100 |
| YT-7675 | 1/4" (6.3 mm) | PH3 | 37     | 44.4                               | 10/100 |

| YATO    | Ø             | ⊕   | L (mm) | torque / moment obrotowy max. (Nm) | ☐      |
|---------|---------------|-----|--------|------------------------------------|--------|
| YT-7676 | 1/4" (6.3 mm) | PZ1 | 37     | 6.2                                | 10/100 |
| YT-7677 | 1/4" (6.3 mm) | PZ2 | 37     | 20.1                               | 10/100 |
| YT-7678 | 1/4" (6.3 mm) | PZ3 | 37     | 44.1                               | 10/100 |

- GB Star bit sockets  
D Aufsteckschlüssel  
PL Klucze trzpieniowe  
RUS Набор головок-вставок  
CZ Čepové klíče  
H Csapkulcs
- RO Chei cu cozi  
F Douille tournevis  
I Chiavi a bussola  
E Llaves de mandril  
CN 星型旋具套筒



SLIDING CARD

|          |           |
|----------|-----------|
| 3/8"     | AISI S2   |
| 10mm     |           |
| DIN 3120 | HRC 58-62 |

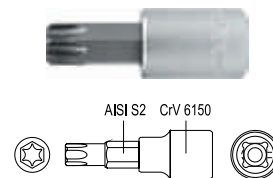

| YATO    | Ø             | ☆   | L (mm) | torque / moment obrotowy max. (Nm) | ☐      |
|---------|---------------|-----|--------|------------------------------------|--------|
| YT-7686 | 3/8" (9.5 mm) | T27 | 50     | 34.8                               | 10/100 |

- GB Star bit sockets  
D Aufsteckschlüssel  
PL Klucze trzpieniowe  
RUS Набор головок-вставок  
CZ Čepové klíče  
H Csapkulcs
- RO Chei cu cozi  
F Douille tournevis  
I Chiavi a bussola  
E Llaves de mandril  
CN 星型旋具套筒



SLIDING CARD

|          |           |
|----------|-----------|
| 1/2"     | AISI S2   |
| 12.5mm   |           |
| DIN 3120 | HRC 58-62 |

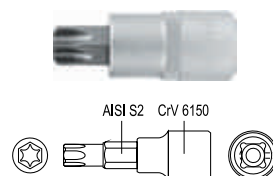
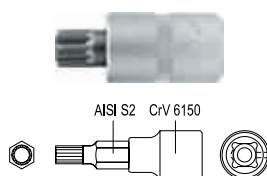
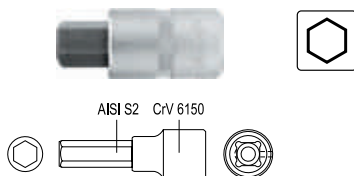

| YATO    | Ø              | ⬡  | L (mm) | torque / moment obrotowy max. (Nm) | ☐      |
|---------|----------------|----|--------|------------------------------------|--------|
| YT-7723 | 1/2" (12.7 mm) | 4  | 50     | 26.3                               | 10/100 |
| YT-7724 | 1/2" (12.7 mm) | 5  | 50     | 52.7                               | 10/100 |
| YT-7725 | 1/2" (12.7 mm) | 6  | 50     | 89.0                               | 10/100 |
| YT-7726 | 1/2" (12.7 mm) | 7  | 50     | 128.7                              | 10/100 |
| YT-7727 | 1/2" (12.7 mm) | 8  | 50     | 174.1                              | 10/100 |
| YT-7728 | 1/2" (12.7 mm) | 10 | 50     | 220.0                              | 10/100 |
| YT-7729 | 1/2" (12.7 mm) | 12 | 50     | 370.0                              | 10/100 |
| YT-7730 | 1/2" (12.7 mm) | 14 | 50     | 590.0                              | 10/100 |
| YT-7731 | 1/2" (12.7 mm) | 17 | 50     | 1000.0                             | 10/100 |

| YATO    | Ø              | ⬡   | L (mm) | torque / moment obrotowy max. (Nm) | ☐      |
|---------|----------------|-----|--------|------------------------------------|--------|
| YT-7732 | 1/2" (12.7 mm) | M5  | 50     | 33.9                               | 10/100 |
| YT-7733 | 1/2" (12.7 mm) | M6  | 50     | 60.8                               | 10/100 |
| YT-7734 | 1/2" (12.7 mm) | M8  | 50     | 104.2                              | 10/100 |
| YT-7735 | 1/2" (12.7 mm) | M10 | 50     | 176.5                              | 10/100 |
| YT-7736 | 1/2" (12.7 mm) | M12 | 50     | 220.0                              | 10/100 |
| YT-7737 | 1/2" (12.7 mm) | M14 | 50     | 370.0                              | 10/100 |
| YT-7738 | 1/2" (12.7 mm) | M16 | 50     | 590.0                              | 10/100 |

| YATO    | Ø              | ☆   | L (mm) | torque / moment obrotowy max. (Nm) | ☐      |
|---------|----------------|-----|--------|------------------------------------|--------|
| YT-7713 | 1/2" (12.7 mm) | T20 | 50     | 17.9                               | 10/100 |
| YT-7714 | 1/2" (12.7 mm) | T25 | 50     | 25.5                               | 10/100 |
| YT-7715 | 1/2" (12.7 mm) | T27 | 50     | 34.1                               | 10/100 |
| YT-7716 | 1/2" (12.7 mm) | T30 | 50     | 42.6                               | 10/100 |
| YT-7717 | 1/2" (12.7 mm) | T40 | 50     | 76.7                               | 10/100 |
| YT-7718 | 1/2" (12.7 mm) | T45 | 50     | 117.0                              | 10/100 |
| YT-7719 | 1/2" (12.7 mm) | T50 | 50     | 176.5                              | 10/100 |
| YT-7720 | 1/2" (12.7 mm) | T55 | 50     | 218.0                              | 10/100 |
| YT-7721 | 1/2" (12.7 mm) | T60 | 50     | 379.0                              | 10/100 |
| YT-7722 | 1/2" (12.7 mm) | T70 | 50     | 590.0                              | 10/100 |

- GB Star bit sockets
  - D Aufsteckschlüssel
  - PL Klucze trzpieniowe
  - RUS Набор головок-вставок
  - CZ Čepové klíče
  - H Csapkulcs
- RO Chei cu cozi
  - F Douille tournevis
  - I Chiavi a bussola
  - E Llaves de mandril
  - CN 星型旋具套筒

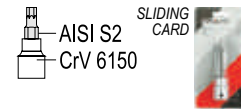

1/2" 12.5mm  
 AISI S2  
 DIN 3120  
 HRC 58-62

2

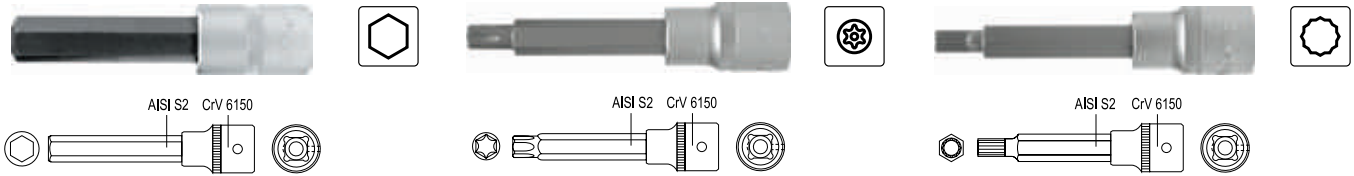

| YATO    | O              | L (mm) | torque / moment obrotowy max. (Nm) |        |
|---------|----------------|--------|------------------------------------|--------|
| YT-7739 | 1/2" (12.7 mm) | 4      | 100                                | 27.5   |
| YT-7740 | 1/2" (12.7 mm) | 5      | 100                                | 53.4   |
| YT-7741 | 1/2" (12.7 mm) | 6      | 100                                | 89.4   |
| YT-7742 | 1/2" (12.7 mm) | 7      | 100                                | 132.2  |
| YT-7743 | 1/2" (12.7 mm) | 8      | 100                                | 176.3  |
| YT-7744 | 1/2" (12.7 mm) | 10     | 100                                | 220.0  |
| YT-7745 | 1/2" (12.7 mm) | 12     | 100                                | 370.0  |
| YT-7746 | 1/2" (12.7 mm) | 14     | 100                                | 590.0  |
| YT-7747 | 1/2" (12.7 mm) | 17     | 100                                | 1000.0 |

| YATO    | O              | L (mm) | torque / moment obrotowy max. (Nm) |       |
|---------|----------------|--------|------------------------------------|-------|
| YT-0434 | 1/2" (12.7 mm) | T20    | 100                                | 12.7  |
| YT-0441 | 1/2" (12.7 mm) | T25    | 100                                | 19.0  |
| YT-0435 | 1/2" (12.7 mm) | T27    | 100                                | 26.9  |
| YT-0442 | 1/2" (12.7 mm) | T30    | 100                                | 37.4  |
| YT-0436 | 1/2" (12.7 mm) | T40    | 100                                | 65.1  |
| YT-0437 | 1/2" (12.7 mm) | T45    | 100                                | 104.0 |
| YT-0443 | 1/2" (12.7 mm) | T50    | 100                                | 159.0 |
| YT-0438 | 1/2" (12.7 mm) | T55    | 100                                | 257.0 |
| YT-0439 | 1/2" (12.7 mm) | T60    | 100                                | 446.0 |
| YT-0440 | 1/2" (12.7 mm) | T70    | 100                                | 701.0 |

| YATO    | O              | L (mm) | torque / moment obrotowy max. (Nm) |       |
|---------|----------------|--------|------------------------------------|-------|
| YT-0450 | 1/2" (12.7 mm) | M5     | 100                                | 16.0  |
| YT-0451 | 1/2" (12.7 mm) | M6     | 100                                | 30.0  |
| YT-0452 | 1/2" (12.7 mm) | M8     | 100                                | 52.0  |
| YT-0453 | 1/2" (12.7 mm) | M10    | 100                                | 120.0 |
| YT-0454 | 1/2" (12.7 mm) | M12    | 100                                | 220.0 |
| YT-0455 | 1/2" (12.7 mm) | M14    | 100                                | 370.0 |
| YT-0456 | 1/2" (12.7 mm) | M16    | 100                                | 590.0 |
| YT-0457 | 1/2" (12.7 mm) | M17    | 100                                | 590.0 |

- GB Star bit sockets
  - D Aufsteckschlüssel
  - PL Klucze trzpieniowe
  - RUS Набор головок-вставок
  - CZ Čepové klíče
  - H Csapkulcs
- RO Chei cu cozi
  - F Douille tournevis
  - I Chiavi a bussola
  - E Llaves de mandril
  - CN 星型旋具套筒



218 Nm max.  
 DIN 3120  
 AISI S2  
 HRC 58-62

7 PCS  
 TORX SPECIAL TAMPERPROOF  
 TOYOTA VW

12 PCS  
 TORX

12 PCS  
 TORX TAMPERPROOF



1/4" (6.3 mm): L=35 mm; TS10, TS15, TS20, TS25, TS27, TS30, TS40

1/4" (6.3 mm): L=35 mm; T8, T10, T15, T20, T25, T27, T30  
 3/8" (9.5 mm): L=50 mm; T40, T45, T47, T50, T55

1/4" (6.3 mm): L=35 mm; T8, T10, T15, T20, T25, T27, T30  
 3/8" (9.5 mm): L=50 mm; T40, T45, T47, T50, T55

|      |         |       |
|------|---------|-------|
| YATO | YT-0461 | 12/48 |
|------|---------|-------|

|      |         |      |
|------|---------|------|
| YATO | YT-0430 | 6/48 |
|------|---------|------|

|      |         |      |
|------|---------|------|
| YATO | YT-0431 | 6/48 |
|------|---------|------|

9 PCS  
 HEX

5 PCS  
 SPLINE



1/4" (6.3 mm): L=35 mm; H2, H3, H4, H5, H6  
 3/8" (9.5 mm): L=50 mm; H7, H8, H10, H12

1/4" (6.3 mm): L=35 mm; M5, M6  
 3/8" (9.5 mm): L=50 mm; M8, M10, M12

|      |         |      |
|------|---------|------|
| YATO | YT-0432 | 6/36 |
|------|---------|------|

|      |         |       |
|------|---------|-------|
| YATO | YT-0433 | 12/48 |
|------|---------|-------|



GB Bit socket set  
D Aufsteckschlüssel-Satz  
PL Zestaw kluczy trzpieniowych  
RUS Набор головок-вставок

CZ Čepové klíče  
H Csapkulcs  
RO Chei cu cozi  
F Set de douilles tournevis

I Chiavi a bussola a vite  
E Juego de llaves de mandril  
CN 套筒批头组套

BMC  
& COLOR  
SLEEVE



|            |             |              |
|------------|-------------|--------------|
| 18<br>PCS  | 1/2"        | 1/4"         |
|            | 12.5mm      | 6.3mm        |
|            | CrV<br>6150 | HRC<br>58-62 |
| AISI<br>S2 | DIN<br>3120 |              |



- 1/4" (6.3 mm): 4, 5.5, 6.5 mm (L=37 mm); AISI S2 / CrV 6150;
- 1/4" (6.3 mm): PH1, PH2, PH3 (L=37 mm); AISI S2 / CrV 6150;
- 1/2" (12.7 mm): M5, M6, M8, M10, M12, M14 (L=50 mm);  
M5, M6, M8, M10, M12, M14 (L=100 mm); AISI S2 / CrV 6150

| YATO    | 1/2" (12.7 mm) | 1/4" (6.3 mm) | 10 |
|---------|----------------|---------------|----|
| YT-7750 |                |               |    |



- 1/2" (12.7 mm): T30, T40, T45, T50, T55, T60 (L=50 mm);  
T30, T40, T45, T50, T55, T60 (L=100 mm); AISI S2 / CrV 6150;
- 1/4" (6.3 mm): T10, T15, T20, T25, T30, T40 (L=37 mm); AISI S2 / CrV 6150

| YATO    | 1/2" (12.7 mm) | 1/4" (6.3 mm) | 10 |
|---------|----------------|---------------|----|
| YT-7751 |                |               |    |



- 1/2" (12.7 mm): 5, 6, 7, 8, 10, 12 mm (L=50 mm);  
5, 6, 7, 8, 10, 12 mm (L=100 mm); AISI S2 / CrV 6150;
- 1/4" (6.3 mm): 3, 4, 5, 6, 7, 8 mm (L=37 mm); AISI S2 / CrV 6150

| YATO    | 1/2" (12.7 mm) | 1/4" (6.3 mm) | 10 |
|---------|----------------|---------------|----|
| YT-7752 |                |               |    |

GB Bit socket set  
D Aufsteckschlüssel-Satz  
PL Zestaw kluczy trzpieniowych  
RUS Набор головок-вставок

CZ Čepové klíče  
H Csapkulcs  
RO Chei cu cozi  
F Set de douilles tournevis

I Chiavi a bussola a vite  
E Juego de llaves de mandril  
CN 套筒批头组套

BMC  
& COLOR  
SLEEVE



|           |            |              |
|-----------|------------|--------------|
| 12<br>PCS | 1/2"       | CrV<br>6150  |
|           | 12.5mm     | HRC<br>58-62 |
|           | AISI<br>S2 | DIN<br>3120  |



- 1/2" (12.7 mm): M12, M17 (L=50 mm); M6 (L=70 mm); M7, M8 (L=100 mm);  
M8, M10 (L=120 mm); M6, M10, M12 (L=140 mm); M5 (L=180 mm);  
M6 (L=250 mm); AISI S2 / CrV 6150

| YATO    | 1/2" (12.7 mm) | 10 |
|---------|----------------|----|
| YT-7753 |                |    |

# 3

**Impact sockets,  
accessories & sets**  
**Udarowe klucze nasadowe,  
akcesoria i zestawy**





|  |   |    |
|--|---|----|
| <b>Impact sockets 3/8"</b><br>Klucze nasadowe udarowe 3/8" |  | 78 |
|--|---|----|

|  |    |
|--|----|
| <b>Impact sockets sets</b><br>Zestawy kluczy nasadowych udarowych krótkich | 78 |
|--|----|

|  |   |       |
|--|---|-------|
| <b>Impact sockets 1/2"</b><br>Klucze nasadowe udarowe 1/2" |  | 78-79 |
|--|---|-------|

|  |    |
|--|----|
| <b>Impact sockets &amp; sets</b><br>Klucze nasadowe udarowe i zestawy, krótkie     | 78 |
| <b>Impact sockets, CrV</b><br>Klucze nasadowe udarowe, krótkie, CrV                | 78 |
| <b>Deep impact sockets &amp; sets</b><br>Klucze nasadowe udarowe i zestawy, długie | 79 |
| <b>Deep non-slip impact sockets</b><br>Udarowe nasadki „Non-slip”, długie          | 79 |

|  |   |    |
|--|---|----|
| <b>Impact accessories 1/2"</b><br>Akcesoria udarowe 1/2" |  | 80 |
|--|---|----|

|  |    |
|--|----|
| <b>Impact extension bars</b><br>Przedłużki udarowe         | 80 |
| <b>Impact adapters</b><br>Redukcje udarowe                 | 80 |
| <b>Impact universal joints</b><br>Przeguby kuliste udarowe | 80 |

|  |   |       |
|--|---|-------|
| <b>Impact sockets 3/4"</b><br>Udarowe klucze nasadowe 3/4" |  | 81-82 |
|--|---|-------|

|  |    |
|--|----|
| <b>Impact sockets &amp; sets</b><br>Klucze nasadowe udarowe i zestawy, krótkie     | 81 |
| <b>Deep impact sockets &amp; sets</b><br>Klucze nasadowe udarowe i zestawy, długie | 81 |

|  |   |    |
|--|---|----|
| <b>Impact accessories 3/4"</b><br>Akcesoria udarowe 3/4" |  | 82 |
|--|---|----|

|  |    |
|--|----|
| <b>Impact extension bars</b><br>Przedłużki udarowe         | 82 |
| <b>Impact adapters</b><br>Redukcje udarowe                 | 82 |
| <b>Impact universal joints</b><br>Przeguby kuliste udarowe | 82 |

|  |   |    |
|--|---|----|
| <b>Impact sockets 1"</b><br>Udarowe klucze nasadowe 1" |  | 83 |
|--|---|----|

|   |    |
|---|----|
| <b>Impact sockets</b><br>Klucze nasadowe udarowe, krótkie     | 83 |
| <b>Deep impact sockets</b><br>Klucze nasadowe udarowe, długie | 83 |

|  |   |    |
|--|---|----|
| <b>Impact accessories 1"</b><br>Akcesoria udarowe 1" |  | 83 |
|--|---|----|

|  |    |
|--|----|
| <b>Impact extension bars with adapter</b><br>Przedłużki udarowe z redukcją | 83 |
|--|----|

|  |   |    |
|--|---|----|
| <b>Impact sockets for front hub nuts</b><br>Nasadki udarowe do piast |  | 84 |
|--|---|----|

|   |   |    |
|---|---|----|
| <b>Impact bit socket sets 1/2"</b><br>Zestawy udarowych kluczy trzpieniowych 1/2" |  | 84 |
|---|---|----|

|   |  |    |
|---|--|----|
| <b>Spline impact bit sets 3/4"</b><br>Zestawy bitów udarowych „Spline” 3/4" |  | 84 |
|---|--|----|

GB Impact socket set  
D Kraftschrauber-Einsatz  
PL Zestaw nasadek udarowych  
RUS Набор торцевых ударных головок

CZ Sada nástrčných klíčů pro úderové utahováký  
H Dugófej készlet ütvebehajtóhoz  
RO Set chei tubulare pt. impact  
F Douille profonde à choc

I Chiave a bussola esagonale per percussione  
E Juego de boquillas de percusión cortas  
CN 风动套筒组套

METAL CASE & COLOR BOX



10 PCS

3/8" 10mm

CrMo SCM-440



3/8" (9.5 mm): 10, 12, 13, 14, 15, 16, 17, 18, 19, 22 mm (L=39 mm)

|             |               |    |
|-------------|---------------|----|
| <b>YATO</b> |               |    |
| YT-37690    | 3/8" (9.5 mm) | 20 |

GB Hexagonal impact socket  
D Kraftschrauber-Einsatz  
PL Nasadka udarowa sześciokątna  
RUS Головка ударная 6-гранная  
CZ Šestihranný nástavec  
H Hatszögű rátét  
RO Cheie tubulară hexagonală de impact  
F Douille à choc  
I Chiave a bussola esagonale per percussione  
E Boquilla de percusión  
CN 六角风动套筒

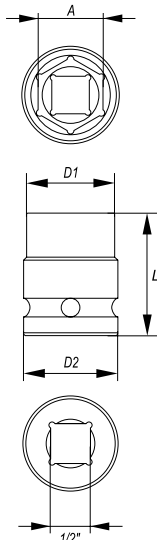

COLOR BOX



1/2" 12.5mm

CrMo SCM-440

AS-DRIVE

| YATO    | ∅ A (mm) | D1 (mm) | D2 (mm) | L (mm) | PCS packing: |     |
|---------|----------|---------|---------|--------|--------------|-----|
| YT-1000 | 10       | 17.5    | 25.0    | 39     | 60           | 240 |
| YT-1001 | 11       | 18.5    | 25.0    | 39     | 60           | 240 |
| YT-1002 | 12       | 20.0    | 25.0    | 39     | 60           | 240 |
| YT-1003 | 13       | 21.0    | 25.0    | 39     | 60           | 240 |
| YT-1004 | 14       | 22.5    | 25.0    | 39     | 60           | 240 |
| YT-1005 | 15       | 23.5    | 30.0    | 39     | 40           | 160 |
| YT-1006 | 16       | 24.0    | 30.0    | 39     | 40           | 160 |
| YT-1007 | 17       | 26.0    | 30.0    | 39     | 40           | 160 |
| YT-1008 | 18       | 27.5    | 30.0    | 39     | 40           | 160 |
| YT-1009 | 19       | 28.0    | 30.0    | 39     | 40           | 160 |
| YT-1010 | 20       | 30.0    | 30.0    | 39     | 40           | 160 |
| YT-1011 | 21       | 30.0    | 30.0    | 39     | 40           | 160 |
| YT-1012 | 22       | 32.0    | 30.0    | 39     | 30           | 120 |
| YT-1013 | 23       | 32.0    | 30.0    | 39     | 30           | 120 |
| YT-1014 | 24       | 34.0    | 30.0    | 43     | 30           | 120 |
| YT-1015 | 25       | 35.0    | 30.0    | 43     | 30           | 120 |
| YT-1016 | 26       | 38.0    | 30.0    | 43     | 24           | 96  |
| YT-1017 | 27       | 38.0    | 30.0    | 43     | 24           | 96  |
| YT-1018 | 28       | 40.0    | 30.0    | 48     | 24           | 96  |
| YT-1019 | 29       | 41.0    | 30.0    | 48     | 22           | 88  |
| YT-1020 | 30       | 42.0    | 30.0    | 48     | 24           | 96  |
| YT-1022 | 32       | 44.0    | 30.0    | 48     | 20           | 80  |

GB Impact socket set  
D Kraftschrauber-Einsatz  
PL Zestaw nasadek udarowych  
RUS Набор торцевых ударных головок

CZ Sada nástrčných klíčů pro úderové utahováký  
H Dugófej készlet ütvebehajtóhoz  
RO Set chei tubulare pt. impact  
F Set de douilles à choc

I Chiave a bussola esagonale per percussione  
E Juego de boquillas de percusión cortas  
CN 风动套筒组套

METAL CASE & COLOR BOX



10 PCS

1/2" 12.5mm

CrMo SCM-440

AS-DRIVE



1/2" (12.7 mm): 10, 12, 13, 14, 15, 16, 17, 18, 19, 22 mm (L=39 mm)

|             |                |    |
|-------------|----------------|----|
| <b>YATO</b> |                |    |
| YT-1025     | 1/2" (12.7 mm) | 20 |

GB Hexagonal impact socket  
D Kraftschrauber-Einsatz  
PL Nasadka udarowa sześciokątna  
RUS Головка ударная 6-гранная  
CZ Šestihranný nástavec  
H Hatszögű rátét  
RO Cheie tubulară hexagonală de impact  
F Douille à choc  
I Chiave a bussola esagonale per percussione  
E Boquilla de percusión  
CN 六角风动套筒

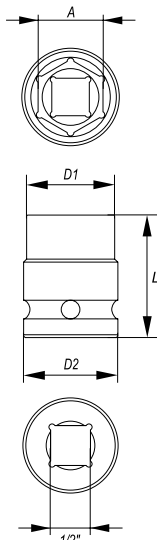

COLOR BOX



1/2" 12.5mm

CrV

AS-DRIVE

| YATO    | ∅ A (mm) | D1 (mm) | D2 (mm) | L (mm) | PCS packing: |     |
|---------|----------|---------|---------|--------|--------------|-----|
| YT-1781 | 9        | 15.5    | 24.0    | 38     | 12           | 240 |
| YT-1792 | 20       | 30.0    | 30.0    | 38     | 12           | 144 |
| YT-1795 | 23       | 34.0    | 34.0    | 40     | 12           | 96  |
| YT-1797 | 27       | 37.5    | 37.5    | 41     | 10           | 80  |
| YT-1799 | 32       | 44.0    | 44.0    | 44     | 10           | 80  |



- GB Hexagonal deep impact socket  
D Kraftschrauber-Einsatz, lang  
PL Nasadka udarowa sześciokątna długa  
RUS Головка ударная 6-гранная глубокая  
CZ Šestihranný hluboký nástavec  
H Hatszögű rátét mély  
RO Cheie tubulară hexagonală de impact adâncă  
F Douille profonde à choc  
I Chiave a bussola esagonale per percussione  
E Boquilla de percusión profunda  
CN 六角风动长套筒

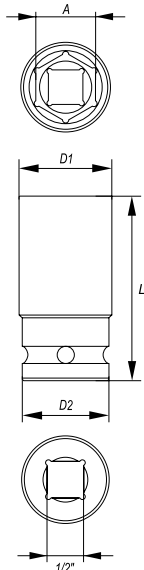

COLOR BOX



1/2"  
12.5mm

CrMo  
SCM-440

AS-DRIVE

| YATO    | ∅ A (mm) | D1 (mm) | D2 (mm) | L (mm) | PCS packing: |     |
|---------|----------|---------|---------|--------|--------------|-----|
| YT-1030 | 10       | 17.5    | 24.0    | 78     | 30           | 120 |
| YT-1031 | 11       | 18.5    | 24.0    | 78     | 30           | 120 |
| YT-1032 | 12       | 20.0    | 24.0    | 78     | 30           | 120 |
| YT-1033 | 13       | 21.0    | 24.0    | 78     | 30           | 120 |
| YT-1034 | 14       | 22.0    | 24.0    | 78     | 30           | 120 |
| YT-1035 | 15       | 23.7    | 24.0    | 78     | 30           | 120 |
| YT-1036 | 16       | 24.0    | 24.0    | 78     | 30           | 120 |
| YT-1037 | 17       | 26.0    | 26.0    | 78     | 25           | 100 |
| YT-1038 | 18       | 28.0    | 28.0    | 78     | 24           | 96  |
| YT-1039 | 19       | 28.0    | 28.0    | 78     | 24           | 96  |
| YT-1040 | 20       | 30.0    | 30.0    | 78     | 20           | 80  |
| YT-1041 | 21       | 30.0    | 30.0    | 78     | 20           | 80  |
| YT-1042 | 22       | 32.0    | 30.0    | 78     | 18           | 72  |
| YT-1043 | 23       | 32.0    | 30.0    | 78     | 15           | 60  |
| YT-1044 | 24       | 34.0    | 30.0    | 78     | 15           | 60  |
| YT-1045 | 25       | 35.0    | 30.0    | 78     | 15           | 60  |
| YT-1046 | 26       | 38.0    | 30.0    | 78     | 12           | 48  |
| YT-1047 | 27       | 38.0    | 30.0    | 78     | 12           | 48  |
| YT-1048 | 28       | 40.0    | 30.0    | 78     | 12           | 48  |
| YT-1049 | 29       | 41.0    | 30.0    | 78     | 10           | 40  |
| YT-1050 | 30       | 42.0    | 30.0    | 78     | 10           | 40  |
| YT-1052 | 32       | 44.0    | 30.0    | 78     | 10           | 40  |

- GB Impact socket set  
D Kraftschrauber-Einsätze  
PL Zestaw nasadek udarowych  
RUS Набор торцевых ударных головок  
CZ Sada nástrčných klíčů pro úderové utahováky  
H Dugófej készlet ütvebehajtóhoz

- RO Set chei tubulare pt. impact  
F Set de douilles à choc  
I Chiave a bussola esagonale per percussione  
E Juego de boquillas de percusión cortas  
CN 风动套筒组套

METAL CASE & COLOR BOX



1/2"  
12.5mm

CrMo  
SCM-440

AS-DRIVE



11  
PCS

1/2" (12.7 mm): 10, 12, 13, 14, 15, 16, 17, 18, 19, 22, 24 mm (L=39 mm)

15  
PCS

1/2" (12.7 mm): 10, 12, 13, 14, 15, 16, 17, 18, 19, 21, 22, 24, 27, 30, 32 mm (L=39 mm)

| YATO    | ∅              |    |
|---------|----------------|----|
| YT-1054 | 1/2" (12.7 mm) | 10 |

| YATO    | ∅              |   |
|---------|----------------|---|
| YT-1055 | 1/2" (12.7 mm) | 4 |

- GB Hexagonal deep impact socket NON-SLIP  
D Kraftschrauber-Einsatz, lang NON-SLIP  
PL Nasadka udarowa sześciokątna długa NON-SLIP  
RUS Головка ударная 6-гранная глубокая NON-SLIP  
CZ Šestihranný hluboký nástavec NON-SLIP  
H Hatszögű rátét mély NON-SLIP  
RO Cheie tubulară hexagonală de impact adâncă NON-SLIP  
F Douille à choc NON-SLIP longue  
I Chiave a bussola esagonale lunga  
E Boquilla de percusión profunda NON-SLIP  
CN 风动防滑长套筒

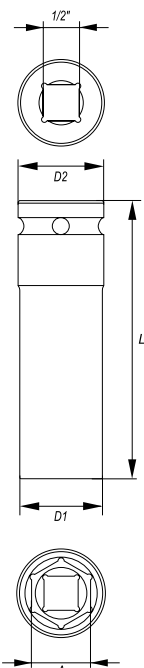

PLASTIC HANGER



10 PCS

COLOR BOX



1/2"  
12.5mm

CrMo  
SCM-440

NON-SLIP  
SYSTEM

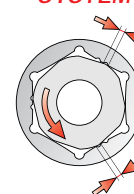

| YATO    | ∅ A (mm) | D1 (mm) | D2 (mm) | L (mm) | PCS packing: |     |
|---------|----------|---------|---------|--------|--------------|-----|
| YT-1588 | 10       | 12.40   | 19.55   | 80     | 10           | 160 |
| YT-1589 | 11       | 18.90   | 19.60   | 80     | 10           | 160 |
| YT-1590 | 12       | 19.90   | 24.62   | 80     | 10           | 160 |
| YT-1591 | 13       | 20.95   | 24.70   | 80     | 10           | 160 |
| YT-1592 | 14       | 22.88   | 24.74   | 80     | 10           | 160 |
| YT-1593 | 15       | 23.85   | 24.63   | 80     | 10           | 120 |
| YT-1594 | 16       | 24.64   | 24.64   | 80     | 10           | 120 |
| YT-1596 | 18       | 27.90   | 29.78   | 80     | 10           | 100 |
| YT-1598 | 21       | 31.70   | 29.90   | 80     | 10           | 80  |
| YT-1599 | 24       | 34.75   | 30.10   | 80     | 10           | 80  |

- GB Impact extension bar
- D Verlängerung
- PL Przedłużka udarowa
- RUS Удлинитель ударный
- CZ Prodlužovací příravek
- H Toldalék
- RO Prelungitor
- F Rallonge
- I Prolunga per percussione
- E Tubo de prolongación
- CN 风动接杆

1/2"  
12.5mm CrMo  
SCM-440

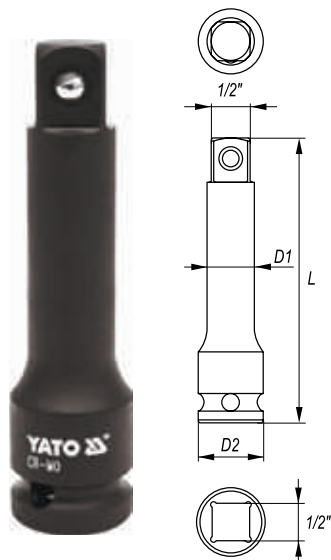

COLOR BOX



| YATO    | Ø              | D1 (mm) | D2 (mm) | L (mm) | PCS packing |     |
|---------|----------------|---------|---------|--------|-------------|-----|
| YT-1060 | 1/2" (12.7 mm) | 17.5    | 25.0    | 75     | 40          | 160 |
| YT-1061 | 1/2" (12.7 mm) | 18.5    | 25.0    | 125    | 28          | 112 |
| YT-1062 | 1/2" (12.7 mm) | 20.0    | 25.0    | 250    | 30          | 60  |

- GB Impact adapter
- D Reduktion
- PL Redukcja udarowa
- RUS Переходник
- CZ Redukce
- H Redukció
- RO Reducție
- F Réduction
- I Prolunga per percussione
- E Reducción
- CN 风动转换头

1/2"  
12.5mm CrMo  
SCM-440

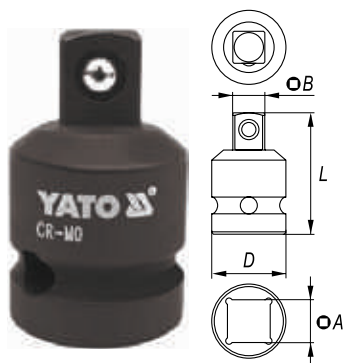

COLOR BOX



| YATO    | Ø                  | Ø                  | D (mm) | L (mm) | PCS packing |     |
|---------|--------------------|--------------------|--------|--------|-------------|-----|
| YT-1067 | 1/2" (12.7 mm) (F) | 3/4" (19.0 mm) (M) | 30     | 48     | 40          | 160 |

- GB Impact universal joint
- D Gelenkstück
- PL Przegub kulisty udarowy
- RUS Кардан ударный
- CZ Kloub kulový
- H Univerzális csuklós csatlakozó
- RO Adaptor
- F Flector rond
- I Prolunga per percussione
- E Articulación redonda
- CN 风动万向接头

1/2"  
12.5mm CrMo  
SCM-440



COLOR BOX



| YATO    | Ø              | D1 (mm) | D2 (mm) | L (mm) | PCS packing |     |
|---------|----------------|---------|---------|--------|-------------|-----|
| YT-1064 | 1/2" (12.7 mm) | 31      | 17      | 63     | 25          | 100 |



- GB Hexagonal impact socket  
D Kraftschrauber-Einsatz  
PL Nasadka udarowa sześciokątna  
RUS Головка ударная 6-гранная  
CZ Šestihranný nástavec  
H Hatszögű rátét  
RO Cheie tubulară hexagonală de impact  
F Douille à choc  
I Chiave a bussola esagonale per percussione  
E Boquilla de percusión  
CN 六角风动套筒

COLOR BOX



3/4"  
19mm  
CrMo  
SCM-440  
AS-DRIVE

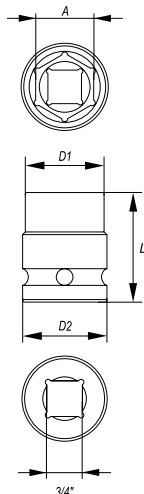

| YATO    | ∅ A (mm) | D1 (mm) | D2 (mm) | L (mm) | PCS packing: |    |
|---------|----------|---------|---------|--------|--------------|----|
| YT-1070 | 19       | 32      | 40      | 50     | 16           | 64 |
| YT-1071 | 21       | 35      | 40      | 50     | 16           | 64 |
| YT-1072 | 22       | 38      | 40      | 50     | 16           | 64 |
| YT-1073 | 23       | 38      | 40      | 50     | 16           | 64 |
| YT-1074 | 24       | 40      | 40      | 50     | 16           | 64 |
| YT-1075 | 25       | 40      | 40      | 50     | 16           | 64 |
| YT-1076 | 26       | 40      | 40      | 50     | 16           | 64 |
| YT-1077 | 27       | 42      | 42      | 53     | 16           | 64 |
| YT-1078 | 28       | 44      | 44      | 53     | 16           | 64 |
| YT-1079 | 29       | 46      | 44      | 53     | 12           | 48 |
| YT-1080 | 30       | 46      | 44      | 53     | 12           | 48 |
| YT-1082 | 32       | 48      | 44      | 56     | 12           | 48 |
| YT-1083 | 33       | 48      | 44      | 56     | 8            | 32 |
| YT-1084 | 34       | 50      | 44      | 56     | 8            | 32 |
| YT-1085 | 35       | 50      | 44      | 56     | 6            | 24 |
| YT-1086 | 36       | 52      | 44      | 56     | 6            | 24 |
| YT-1088 | 38       | 56      | 44      | 57     | 6            | 24 |
| YT-1091 | 41       | 60      | 44      | 57     | 5            | 20 |
| YT-1092 | 42       | 61      | 44      | 57     | 4            | 16 |
| YT-1093 | 43       | 63      | 44      | 57     | 4            | 16 |
| YT-1096 | 46       | 66      | 44      | 62     | 3            | 12 |
| YT-1098 | 48       | 68      | 44      | 67     | 3            | 12 |
| YT-1100 | 50       | 71      | 54      | 72     | 3            | 12 |
| YT-1102 | 52       | 74      | 54      | 72     | 2            | 8  |
| YT-1105 | 55       | 78      | 54      | 74     | 2            | 8  |
| YT-1110 | 60       | 84      | 54      | 74     | 2            | 8  |

- GB Impact socket set  
D Kraftschrauber-Einsätze  
PL Zestaw nasadek udarowych  
RUS Набор торцевых ударных головок  
CZ Sada nástrčných klíčů pro úderové utahováky  
H Dugófej készlet ütvebehajtóhoz
- RO Set chei tubulare pt. impact  
F Set de douilles à choc  
I Chiave a bussola esagonale per percussione  
E Juego de boquillas de percusión cortas  
CN 风动套筒组套



METAL CASE & COLOR BOX

8  
PCS  
3/4"  
19mm  
CrMo  
SCM-440  
AS-DRIVE



3/4" (19.0 mm): 22, 24 mm (L=50 mm); 27, 30 mm (L=53 mm);  
32, 36 mm (L=55 mm); 38, 41 mm (L=57 mm)

| YATO    | ∅              |   |
|---------|----------------|---|
| YT-1115 | 3/4" (19.0 mm) | 6 |

- GB Hexagonal deep impact socket  
D Kraftschrauber-Einsatz, lang  
PL Nasadka udarowa sześciokątna długa  
RUS Головка ударная 6-гранная глубокая  
CZ Šestihranný hluboký nástavec  
H Hatszögű rátét mély  
RO Cheie tubulară hexagonală de impact adâncă
- F Douille profonde à choc  
I Chiave a bussola esagonale per percussione  
E Boquilla de percusión profunda  
CN 六角风动长套筒

COLOR BOX



3/4"  
19mm  
CrMo  
SCM-440  
AS-DRIVE

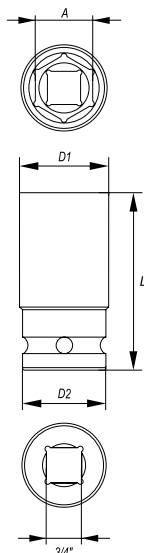

| YATO    | ∅ A (mm) | D1 (mm) | D2 (mm) | L (mm) | PCS packing: |    |
|---------|----------|---------|---------|--------|--------------|----|
| YT-1119 | 19       | 32      | 44      | 90     | 9            | 36 |
| YT-1121 | 21       | 35      | 44      | 90     | 9            | 36 |
| YT-1122 | 22       | 38      | 44      | 90     | 9            | 36 |
| YT-1123 | 23       | 38      | 44      | 90     | 9            | 36 |
| YT-1124 | 24       | 40      | 44      | 90     | 9            | 36 |
| YT-1125 | 25       | 40      | 44      | 90     | 9            | 36 |
| YT-1127 | 27       | 42      | 44      | 90     | 9            | 36 |
| YT-1128 | 28       | 44      | 44      | 90     | 8            | 32 |
| YT-1129 | 29       | 44      | 44      | 90     | 8            | 32 |
| YT-1130 | 30       | 46      | 44      | 90     | 7            | 28 |
| YT-1132 | 32       | 48      | 44      | 90     | 7            | 28 |
| YT-1133 | 33       | 50      | 44      | 90     | 6            | 24 |
| YT-1134 | 34       | 51      | 44      | 90     | 6            | 24 |
| YT-1135 | 35       | 52      | 44      | 90     | 6            | 24 |
| YT-1136 | 36       | 54      | 44      | 90     | 6            | 24 |
| YT-1138 | 38       | 56      | 44      | 90     | 6            | 24 |
| YT-1141 | 41       | 60      | 44      | 90     | 5            | 20 |
| YT-1142 | 42       | 61      | 44      | 90     | 4            | 16 |
| YT-1143 | 43       | 63      | 44      | 90     | 3            | 12 |
| YT-1146 | 46       | 66      | 44      | 90     | 3            | 12 |
| YT-1148 | 48       | 68      | 44      | 90     | 2            | 8  |
| YT-1150 | 50       | 71      | 54      | 90     | 2            | 8  |

GB Impact socket set  
 D Kraftschrauber-Einsätze  
 PL Zestaw nasadek udarowych  
 RUS Набор торцевых ударных головок

CZ Sada nástrčných kľúčů pro úderové utahovky  
 H Dugófej készlet ütvebehajtóhoz  
 RO Set chei tubulare pt. impact  
 F Douille profonde à choc

I Chiave a bussola esagonale per percussione  
 E Juego de boquillas de percusión cortas  
 CN 风动长套筒组套



8 PCS

3/4" 19mm

CrMo SCM-440

AS-DRIVE



3/4" (19.0 mm): 22, 24, 27, 30, 32, 36, 38, 41 mm (L=90 mm)

|             |                |   |
|-------------|----------------|---|
| <b>YATO</b> | ○              |   |
| YT-1155     | 3/4" (19.0 mm) | 4 |

GB Impact extension bar  
 D Verlängerung  
 PL Przedłużka udarowa  
 RUS Удлинитель ударный  
 CZ Prodlužovací přípravek  
 H Toldalék  
 RO Prelungitor  
 F Rallonge  
 I Prolunga per percussione  
 E Tubo de prolongación  
 CN 风动接杆

3/4" 19mm CrMo SCM-440

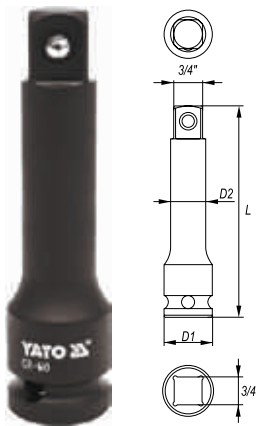

COLOR BOX



| YATO    | ○              | D1 (mm) | D2 (mm) | L (mm) | PCS packing: |    |
|---------|----------------|---------|---------|--------|--------------|----|
| YT-1160 | 3/4" (19.0 mm) | 44      | 24      | 100    | 8            | 32 |
| YT-1161 | 3/4" (19.0 mm) | 44      | 24      | 175    | 10           | 20 |
| YT-1162 | 3/4" (19.0 mm) | 44      | 24      | 250    | 8            | 16 |
| YT-1163 | 3/4" (19.0 mm) | 44      | 24      | 330    | 6            | 12 |

GB Impact adapter  
 D Reduktion  
 PL Redukcja udarowa  
 RUS Переходник  
 CZ Redukce  
 H Redukció  
 RO Reducție

F Réduction  
 I Prolunga per percussione  
 E Reducción  
 CN 风动转换头

3/4" 19mm CrMo SCM-440

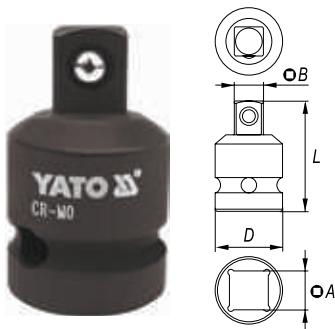

COLOR BOX



| YATO    | ○                  | ○                | D (mm) | L (mm) | PCS packing: |    |
|---------|--------------------|------------------|--------|--------|--------------|----|
| YT-1168 | 3/4" (19.0 mm) (F) | 1" (25.4 mm) (M) | 44     | 63     | 12           | 48 |

GB Impact adapter  
 D Reduktion  
 PL Redukcja udarowa  
 RUS Переходник  
 CZ Redukce  
 H Redukció  
 RO Reducție

F Réduction  
 I Prolunga per percussione  
 E Reducción  
 CN 风动转换头

3/4" 19mm CrV 50BV30



COLOR BOX



| YATO     | ○                  | ○                  | D (mm) | L (mm) | PCS packing: |    |
|----------|--------------------|--------------------|--------|--------|--------------|----|
| YT-11671 | 3/4" (19.0 mm) (F) | 1/2" (12.7 mm) (M) | 44     | 55     | 12           | 48 |

GB Impact universal joint  
 D Gelenkstück  
 PL Przegub kulisty udarowy  
 RUS Кардан ударный  
 CZ Kloub kulový  
 H Univerzális csuklós csatlakozó  
 RO Adaptor  
 F Flector rond  
 I Prolunga per percussione  
 E Articulación redonda  
 CN 风动万向接头

3/4" 19mm CrMo SCM-440



COLOR BOX



| YATO    | ○              | D1 (mm) | D2 (mm) | L (mm) | PCS packing: |    |
|---------|----------------|---------|---------|--------|--------------|----|
| YT-1164 | 3/4" (19.0 mm) | 31      | 44      | 102    | 8            | 32 |



- GB Hexagonal impact socket  
D Kraftschrauber-Einsatz  
PL Nasadka udarowa sześciokątna  
RUS Головка ударная 6-гранная  
CZ Šestihranný nástavec  
H Hatszögű rátét  
RO Cheie tubulară hexagonală de impact  
F Douille à choc  
I Chiave a bussola esagonale per percussione  
E Boquilla de percusión  
CN 六角风动套筒

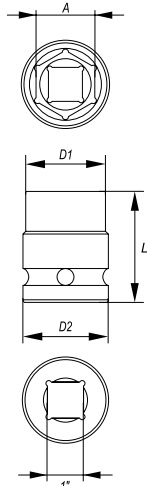

COLOR BOX



1"  
25 mm

CrMo  
SCM-440

AS-DRIVE

| YATO    | ∅ A (mm) | D1 (mm) | D2 (mm) | L (mm) | PCS packing |    |
|---------|----------|---------|---------|--------|-------------|----|
| YT-1180 | 24       | 42      | 54      | 59     | 6           | 24 |
| YT-1182 | 26       | 43      | 54      | 59     | 6           | 24 |
| YT-1183 | 27       | 46      | 54      | 59     | 6           | 24 |
| YT-1184 | 28       | 47      | 54      | 59     | 6           | 24 |
| YT-1185 | 29       | 48      | 54      | 60     | 6           | 24 |
| YT-1186 | 30       | 49      | 54      | 60     | 6           | 24 |
| YT-1187 | 32       | 52      | 54      | 61     | 6           | 24 |
| YT-1188 | 33       | 53      | 54      | 61     | 6           | 24 |
| YT-1189 | 34       | 54      | 54      | 61     | 6           | 24 |
| YT-1191 | 36       | 57      | 54      | 65     | 6           | 24 |
| YT-1193 | 38       | 60      | 54      | 65     | 5           | 20 |
| YT-1194 | 41       | 63      | 54      | 65     | 4           | 16 |
| YT-1195 | 43       | 65      | 54      | 68     | 4           | 16 |
| YT-1196 | 46       | 69      | 54      | 73     | 3           | 12 |
| YT-1197 | 48       | 72      | 54      | 73     | 2           | 8  |
| YT-1198 | 50       | 75      | 54      | 73     | 2           | 8  |

- GB Hexagonal deep impact socket  
D Kraftschrauber-Einsatz, lang  
PL Nasadka udarowa sześciokątna długa  
RUS Головка ударная 6-гранная глубокая  
CZ Šestihranný hluboký nástavec  
H Hatszögű rátét mély  
RO Cheie tubulară hexagonală de impact adâncă  
F Douille profonde à choc  
I Chiave a bussola esagonale per percussione  
E Boquilla de percusión profunda  
CN 六角风动长套筒

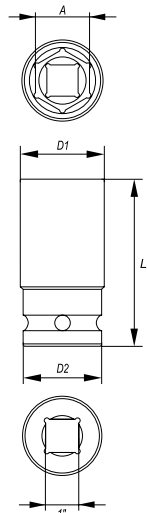

COLOR BOX



1"  
25 mm

CrMo  
SCM-440

AS-DRIVE

| YATO    | ∅ A (mm) | D1 (mm) | D2 (mm) | L (mm) | PCS packing |    |
|---------|----------|---------|---------|--------|-------------|----|
| YT-1175 | 27       | 46      | 54      | 90     | 6           | 24 |
| YT-1176 | 30       | 50      | 54      | 90     | 6           | 24 |
| YT-1177 | 32       | 52      | 54      | 90     | 6           | 24 |
| YT-1178 | 33       | 54      | 54      | 90     | 6           | 24 |
| YT-1179 | 36       | 57      | 54      | 90     | 6           | 24 |

- GB Impact extension bar with adapter  
D Verlängerung mit Adapter  
PL Przedłużka udarowa z redukcją  
RUS Удлинитель с редукцией  
CZ Prodloužení s redukcí  
H Hosszabbító szár adapterrel  
RO Bara extensie cu adaptor  
F Rallonge avec reduction  
I Prolunga per percussione con riduttore  
E Tubo de prolongación con reductor  
CN 风动转换接头

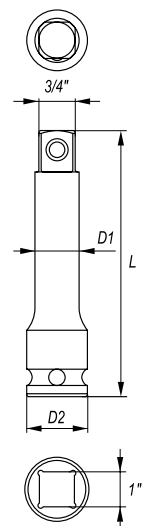

COLOR BOX



1"  
25 mm

CrMo  
SCM-440

| YATO    | ∅ A          | ∅ B           | D1 (mm) | D2 (mm) | L (mm) | PCS packing |      |
|---------|--------------|---------------|---------|---------|--------|-------------|------|
| YT-1169 | 1" (25.4 mm) | 3/4" (19.0mm) | (M)     | 53      | 33     | 250         | 6 12 |

**GB** Hexagonal impact socket  
**D** Kraftschrauber-Einsatz  
**PL** Nasadka uderowa sześciokątna  
**RUS** Головка ударная 6-гранная  
**CZ** Šestihřanný nástavec  
**H** Hatszögű rátét  
**RO** Cheie tubulară hexagonală de impact  
**F** Douille à choc  
**I** Chiave a bussola esagonale per percussione  
**E** Boquilla de percusión  
**CN** 六角风动套筒

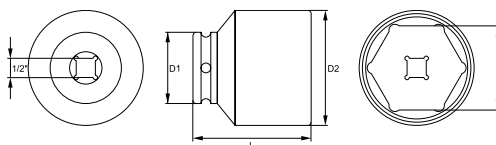

COLOR BOX



1/2"  
12.5mm

FOR FRONT HUB NUTS DO PIAST

CrMo  
SCM-440

AS-DRIVE

| YATO    | Ø A (mm) | D1 (mm) | D2 (mm) | L (mm) | PCS packing: |    |
|---------|----------|---------|---------|--------|--------------|----|
| YT-1029 | 52       | 44      | 71      | 72     | 3            | 12 |

**GB** Bi-hexagonal impact socket  
**D** Zwölfkant-Kraftschrauber-Einsatz  
**PL** Nasadka uderowa dwunastokątna  
**RUS** Головка ударная 12-гранная  
**CZ** Vanáctihřanný nástavec  
**H** Dugófej, 12 lapú  
**RO** Cheie tubulară bihexagonală de impact  
**F** Douille à choc  
**I** Chiave a bussola esagonale per percussione  
**E** Boquilla bihexagonal de percusión  
**CN** 风动套筒

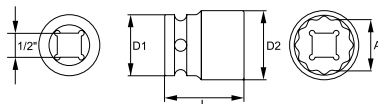

COLOR BOX



1/2"  
12.5mm

FOR FRONT HUB NUTS DO PIAST

CrMo  
SCM-440

AS-DRIVE

| YATO    | Ø A (mm) | D1 (mm) | D2 (mm) | L (mm) | PCS packing: |     |
|---------|----------|---------|---------|--------|--------------|-----|
| YT-1027 | 24       | 30      | 34      | 39     | 10           | 120 |

**GB** Bi-hexagonal deep impact socket  
**D** Zwölfkant-Kraftschrauber-Einsatz, lang  
**PL** Nasadka uderowa dwunastokątna długa  
**RUS** Головка ударная 12-гранная глубокая  
**CZ** Vanáctihřanný hluboký nástavec  
**H** Dugófej, mély, 12 lapú  
**RO** Cheie tubulară bihexagonală de impact adâncă  
**F** Douille à choc  
**I** Chiave a bussola esagonale per percussione  
**E** Boquilla bihexagonal de percusión profunda  
**CN** 风动套筒

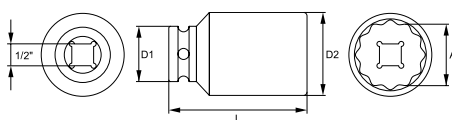

COLOR BOX



1/2"  
12.5mm

FOR FRONT HUB NUTS DO PIAST

CrMo  
SCM-440

AS-DRIVE

| YATO    | Ø A (mm) | D1 (mm) | D2 (mm) | L (mm) | PCS packing: |    |
|---------|----------|---------|---------|--------|--------------|----|
| YT-1028 | 33       | 30      | 45      | 75     | 8            | 32 |

**GB** Impact bit socket set  
**D** Schlagsteckschlüsselsatz  
**PL** Zestaw uderowych kluczy trzpieniowych  
**RUS** Набор ударных торцевых ключей

**CZ** Souprava rázových zástrčných klíčů  
**H** Űthető dugókulcs bit - készlet  
**RO** Set chei de șoc cu bolt  
**F** Set de douilles à choc

**I** Set di chiavi a bussola per percussione  
**E** Juego de llaves de mandril de impacto  
**CN** 风动套筒批头组套

BMC & COLOR SLEEVE



8 PCS

1/2"  
12.5mm

CrMo

HRC 54



T30, T40, T45, T50, T55, T60, TORX T70, T80

6, 7, 8, 10, 12, 14, 17, 19 mm  
HEX

| YATO    | Ø              |    |
|---------|----------------|----|
| YT-1065 | 1/2" (12.7 mm) | 15 |

| YATO    | Ø              |    |
|---------|----------------|----|
| YT-1066 | 1/2" (12.7 mm) | 15 |



RMS, RM6, RM7, RM8, RM10, RM11, RIBE RM12, RM13

M5, M6, M8, M10, M12, M14, M16, M18  
SPLINE

| YATO    | Ø              |    |
|---------|----------------|----|
| YT-1068 | 1/2" (12.7 mm) | 15 |

| YATO    | Ø              |    |
|---------|----------------|----|
| YT-1069 | 1/2" (12.7 mm) | 15 |

**GB** Spline impact bit set  
**D** Schlagwerkzeugsatz - Spline  
**PL** Zestaw bitów uderowych - Spline  
**RUS** Набор ударных битов - Spline  
**CZ** Souprava bitů pro rázové utahováky - Spline  
**H** Űtő bit készlet - Spline  
**RO** Set tubulare de impact  
**F** Set d'embouts à choc  
**I** Set di chiavi a bussola per percussione Spline  
**E** Juego de las piezas de percusión - Spline  
**CN** 风动花键批头组套



BMC & COLOR BOX



6 PCS

3/4"  
19 mm

SPLINE (XZN)

CrMo

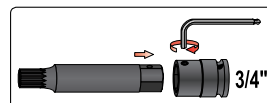

M12, M14, M16, M18 x 22 mm; (L=107 mm); CrMo;  
 3/4" (19.0 mm) x 22 mm; CrMo;

| YATO    | Ø              |   |
|---------|----------------|---|
| YT-1157 | 3/4" (19.0 mm) | 8 |



Memo

# 4

## Torque wrenches & torque multipliers Klucze dynamometryczne i wzmacniacze momentu





Torque wrenches

Klucze dynamometryczne

88



Torque angle gauges

Kątomierze do dokręcania śrub

89



Torque wrenches with metal handle

Klucze dynamometryczne z metalową rączką

88

Torque wrenches with plastic handle

Klucze dynamometryczne z plastikową rączką

88

Torque multipliers

Wzmacniacze momentu

89



GB Torque wrench  
D Drehmomentschlüssel  
PL Klucz dynamometryczny  
RUS Ключ динамометрический

CZ Dynamometrický klíč  
H Nyomatékkulcs  
RO Cheie cu dinamometru  
F Clé dynamométrique

I Chiave dinamometrica  
E Llave dinamométrica  
CN 传统型可调式扭力扳手

1/2" 3/8" CrV  
12.5mm 10mm 6140



BMC

| YATO    | Ø              | Nm     | L (mm) | Box |
|---------|----------------|--------|--------|-----|
| YT-0750 | 3/8" (9.5 mm)  | 20-110 | 366    | 20  |
| YT-0760 | 1/2" (12.7 mm) | 42-210 | 470    | 12  |

GB Torque wrench  
D Drehmomentschlüssel  
PL Klucz dynamometryczny  
RUS Ключ динамометрический

CZ Dynamometrický klíč  
H Nyomatékkulcs  
RO Cheie cu dinamometru  
F Clé dynamométrique

I Chiave dinamometrica  
E Llave dinamométrica  
CN 传统型可调式扭力扳手

3/4" 1/2" CrV  
19mm 12.5mm 6140



BMC

YT-0771

- application: automotive service stations, trucks
- wrench and extension pipe designed to tighten screws in double wheels
- measurement tolerance +/- 3%

YT-0771

- przeznaczenie: serwis, samochody ciężarowe
- łącznie z przedłużką dostosowany do dokręcania śrub w kołach bliźniaczych
- dokładność pomiarowa +/- 3 %

| YATO    | Ø              | Nm      | L (mm) | Box |
|---------|----------------|---------|--------|-----|
| YT-0761 | 1/2" (12.7 mm) | 40-210  | 535    | 10  |
| YT-0770 | 3/4" (19.0 mm) | 100-500 | 865    | 4   |
| YT-0771 | 3/4" (19.0 mm) | 140-980 | 1230   | 2   |

GB Torque wrench  
D Drehmomentschlüssel  
PL Klucz dynamometryczny  
RUS Ключ динамометрический

CZ Dynamometrický klíč  
H Nyomatékkulcs  
RO Cheie cu dinamometru  
F Clé dynamométrique

I Chiave dinamometrica  
E Llave dinamométrica  
CN 传统型可调式扭力扳手

1/4" CrV  
6.3mm 6140



BMC

| YATO    | Ø             | Nm   | L (mm) | Box |
|---------|---------------|------|--------|-----|
| YT-0751 | 1/4" (6.3 mm) | 2-10 | 281    | 24  |

GB Torque wrench  
D Drehmomentschlüssel  
PL Klucz dynamometryczny  
RUS Ключ динамометрический

CZ Dynamometrický klíč  
H Nyomatékkulcs  
RO Cheie cu dinamometru  
F Clé dynamométrique

I Chiave dinamometrica  
E Llave dinamométrica  
CN 传统型可调式扭力扳手

3/4" 1/2" CrV  
19mm 12.5mm 6140



BMC

| YATO    | Ø              | Nm       | L (mm) | Box |
|---------|----------------|----------|--------|-----|
| YT-0754 | 1/2" (12.7 mm) | 60-340   | 613    | 10  |
| YT-0755 | 3/4" (19.0 mm) | 200-1000 | 1234   | 2   |



# Torque wrenches & torque multipliers Klucze dynamometryczne i wzmacniacze momentu



- GB Torque angle gauge
- D Winkelmesser zum Anziehen von Schrauben
- PL Kałomierz do dokręcania śrub
- RUS Угломер для подвёртывания болтов
- CZ Úhloměr k utahování šroubů
- H Nyomaték szögmérő
- RO Raportor pt. înşurubat şuruburi
- F Rapporteur à serrer les vis
- I Goniometro per il serraggio controllo
- E Calibrador para apretar tornillos
- CN 扭力角度规



1/2"  
12.5mm 360° CrV



|             |       |
|-------------|-------|
| <b>YATO</b> |       |
| YT-0593     | 12/48 |

- GB Torque multiplier
- CZ Mechanický posilovač momentu
- I Moltiplicatore di coppia
- D Drehmomentverstärker
- H Nyomaték sokszorozó
- E Mecanismo de reforzar el momento
- PL Mechaniczny wzmacniacz momentu
- RO Antrenor cu amplificator de forta
- CN 3倍扭力倍增器
- RUS Мультипликатор крутящего момента
- F Amplificateur de couple mécanique

3/4" max. 900 Nm 1" max. 2700 Nm 3:1 CrMo 4140

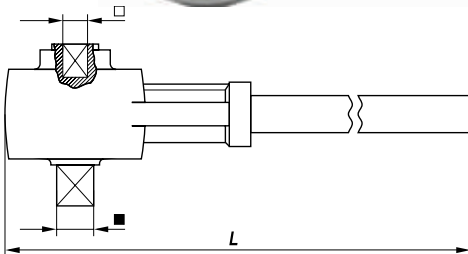

| <b>YATO</b> | F □            | Tmax. (Nm) | M ■          | Tmax. (Nm) | L (mm) |   |
|-------------|----------------|------------|--------------|------------|--------|---|
| YT-0781     | 3/4" (19.0 mm) | 900        | 1" (25.4 mm) | 2700       | 500    | 4 |

- GB Labor save wrench
- D Drehmomentverstärker
- PL Mechaniczny wzmacniacz momentu
- RUS Механический усилитель силы
- CZ Mechanický posilovač momentu
- H Nyomaték sokszorozó
- RO Antrenor cu amplificator de forta
- F Amplificateur de couple mécanique
- I Moltiplicatore di coppia
- E Mecanismo de reforzar el momento
- CN 扭力倍增器

1" 25mm 32.33mm 4200 Nm (max) I-1:3.8 II-1:58 CrV

- GB Labor save wrench
- D Drehmomentverstärker
- PL Mechaniczny wzmacniacz momentu
- RUS Механический усилитель силы
- CZ Mechanický posilovač momentu
- H Nyomaték sokszorozó
- RO Antrenor cu amplificator de forta
- F Amplificateur de couple mécanique
- I Moltiplicatore di coppia
- E Mecanismo de reforzar el momento
- CN 扭力倍增器

1" 25mm 32.33mm 5800 Nm (max) 1:66 CrV



BMC & COLOR SLEEVE



| <b>YATO</b> | Ø            | Nm   | L (mm) |   |
|-------------|--------------|------|--------|---|
| YT-0782     | 1" (25.4 mm) | 4200 | 330    | 1 |



BMC & COLOR SLEEVE



| <b>YATO</b> | Ø            | Nm   | L (mm) |   |
|-------------|--------------|------|--------|---|
| YT-07822    | 1" (25.4 mm) | 5800 | 380    | 1 |

# 5

## Screwdrivers & screwdriver bits Wkrętaki i końcówki wkrętakowe





**Screwdrivers, 2 color handle**  
Wkrętaki, dwukolorowa rączka

92-96



|   |    |
|---|----|
| Slotted screwdrivers<br>Wkrętaki płaskie.....                                   | 92 |
| Phillips screwdrivers<br>Wkrętaki krzyżakowe.....                               | 92 |
| Pozidrive screwdrivers<br>Wkrętaki „Pozidrive”.....                             | 92 |
| Torx screwdrivers<br>Wkrętaki „Torx”.....                                       | 92 |
| Torx Security screwdrivers<br>Wkrętaki „Torx Security”.....                     | 92 |
| Slotted screwdrivers with straight tip<br>Wkrętaki płaskie z wąskim grotem..... | 93 |
| Go-through screwdrivers<br>Wkrętaki do pobijania.....                           | 93 |
| Screwdriver sets<br>Komplety wkrętaków.....                                     | 93 |
| Precision screwdriver sets<br>Zestawy wkrętaków precyzyjnych.....               | 96 |

**Screwdrivers, 3 color handle**  
Wkrętaki, trój kolorowa rączka

97-100



|   |    |
|---|----|
| Slotted screwdrivers<br>Wkrętaki płaskie.....               | 97 |
| Phillips screwdrivers<br>Wkrętaki krzyżakowe.....           | 97 |
| Pozidrive screwdrivers<br>Wkrętaki „Pozidrive”.....         | 97 |
| Torx screwdrivers<br>Wkrętaki „Torx”.....                   | 97 |
| Torx Security screwdrivers<br>Wkrętaki „Torx Security”..... | 97 |
| Go-through screwdrivers<br>Wkrętaki do pobijania.....       | 98 |
| Screwdriver sets<br>Komplety wkrętaków.....                 | 98 |

**Screwdrivers, 3 color handle**  
Wkrętaki, trój kolorowa rączka

101-102



|   |     |
|---|-----|
| Slotted screwdrivers<br>Wkrętaki płaskie.....               | 101 |
| Phillips screwdrivers<br>Wkrętaki krzyżakowe.....           | 101 |
| Pozidrive screwdrivers<br>Wkrętaki „Pozidrive”.....         | 101 |
| Torx screwdrivers<br>Wkrętaki „Torx”.....                   | 101 |
| Torx Security screwdrivers<br>Wkrętaki „Torx Security”..... | 101 |
| Screwdriver sets<br>Komplety wkrętaków.....                 | 102 |

**Precision screwdrivers, 3 color handle**  
Wkrętaki precyzyjne, trój kolorowa rączka

103



|  |     |
|--|-----|
| Precision slotted screwdrivers<br>Wkrętaki precyzyjne płaskie.....       | 103 |
| Precision phillips screwdrivers<br>Wkrętaki precyzyjne krzyżakowe.....   | 103 |
| Precision Pozidrive screwdrivers<br>Wkrętaki precyzyjne „Pozidrive”..... | 103 |
| Precision Torx screwdrivers<br>Wkrętaki precyzyjne „Torx”.....           | 103 |

Precision screwdriver sets

|                                     |     |
|-------------------------------------|-----|
| Zestawy wkrętaków precyzyjnych..... | 103 |
|-------------------------------------|-----|

Insulated screwdrivers

|                         |     |
|-------------------------|-----|
| Wkrętaki izolowane..... | 104 |
|-------------------------|-----|



Insulated slotted screwdrivers

|                                 |     |
|---------------------------------|-----|
| Wkrętaki izolowane płaskie..... | 104 |
|---------------------------------|-----|

Insulated phillips screwdrivers

|                                    |     |
|------------------------------------|-----|
| Wkrętaki izolowane krzyżakowe..... | 104 |
|------------------------------------|-----|

Insulated Pozidrive screwdrivers

|                                     |     |
|-------------------------------------|-----|
| Wkrętaki izolowane „Pozidrive”..... | 104 |
|-------------------------------------|-----|

Insulated screwdriver sets

|                                     |     |
|-------------------------------------|-----|
| Komplety wkrętaków izolowanych..... | 104 |
|-------------------------------------|-----|

Special screwdrivers & impact screwdrivers

|                                   |         |
|-----------------------------------|---------|
| Wkrętaki specjalne i udarowe..... | 105-107 |
|-----------------------------------|---------|



Ratchet screwdriver sets

|                            |     |
|----------------------------|-----|
| Wkrętaki z grzechotką..... | 105 |
|----------------------------|-----|

Impact screwdrivers

|                       |     |
|-----------------------|-----|
| Wkrętaki udarowe..... | 107 |
|-----------------------|-----|

Screwdriver bits

|                          |         |
|--------------------------|---------|
| Końcówki wkrętakowe..... | 108-112 |
|--------------------------|---------|



Phillips screwdriver bits

|                                     |     |
|-------------------------------------|-----|
| Końcówki wkrętakowe krzyżakowe..... | 108 |
|-------------------------------------|-----|

Torx screwdriver bits

|                                 |     |
|---------------------------------|-----|
| Końcówki wkrętakowe „Torx”..... | 108 |
|---------------------------------|-----|

YATO NON-SLIP SYSTEM screwdriver bits

|   |     |
|---|-----|
| Końcówki wkrętakowe „YATO NON-SLIP SYSTEM”..... | 108 |
|---|-----|

Screwdriver bit sets

|                                    |     |
|------------------------------------|-----|
| Zestawy końcówek wkrętakowych..... | 108 |
|------------------------------------|-----|

Nut setters

|                                       |     |
|---------------------------------------|-----|
| Nasadki magnetyczne do wkrętarek..... | 113 |
|---------------------------------------|-----|



Screwdriver bit holders

|                                       |     |
|---------------------------------------|-----|
| Uchwyty do końcówek wkrętakowych..... | 113 |
|---------------------------------------|-----|



Hex & Torx keys & sets

|                                |         |
|--------------------------------|---------|
| Klucze imbusowe i zestawy..... | 113-117 |
|--------------------------------|---------|



Hex keys with handle

|                                   |     |
|-----------------------------------|-----|
| Klucze imbusowe z rękojeścią..... | 113 |
|-----------------------------------|-----|

Hex keys & sets

|                                |     |
|--------------------------------|-----|
| Klucze imbusowe i zestawy..... | 114 |
|--------------------------------|-----|

Torx Tamperproof keys

|   |     |
|---|-----|
| Klucze imbusowe „Torx Tamperproof”..... | 117 |
|---|-----|

Plastic covered Hex keys

|                                |     |
|--------------------------------|-----|
| Klucze imbusowe powlekane..... | 117 |
|--------------------------------|-----|

GB Screwdriver RO Şurubelniță  
 D Schraubendreher F Tournevis  
 PL Wkrętarz I Cacciavite  
 RUS Отвёртка E Destornillador  
 CZ Šroubovák CN 螺丝刀  
 H Csavarhúzó

PLASTIC HANGER



COLOR BOX



PCS packing:



S2

HRC 58



| YATO    | ⊖ | L (mm) | PCS packing: |        |
|---------|---|--------|--------------|--------|
| YT-2675 | 2 | 75     | 12           | 96/384 |
| YT-2760 | 3 | 75     | 12           | 96/384 |
| YT-2761 | 3 | 100    | 12           | 96/384 |
| YT-2715 | 3 | 150    | 12           | 60/240 |
| YT-2716 | 3 | 200    | 12           | 60/240 |
| YT-2676 | 4 | 100    | 12           | 96/384 |
| YT-2677 | 4 | 150    | 12           | 96/384 |
| YT-2678 | 4 | 200    | 12           | 96/384 |

| YATO    | ⊖ | L (mm) | PCS packing: |        |
|---------|---|--------|--------------|--------|
| YT-2679 | 5 | 38     | 12           | 60/240 |
| YT-2762 | 5 | 75     | 12           | 60/240 |
| YT-2763 | 5 | 100    | 12           | 60/240 |
| YT-2764 | 5 | 150    | 12           | 60/240 |
| YT-2717 | 5 | 200    | 12           | 36/144 |
| YT-2718 | 5 | 250    | 6            | 36/144 |
| YT-2719 | 5 | 300    | 6            | 24/96  |
| YT-2765 | 6 | 38     | 12           | 60/240 |

| YATO    | ⊖ | L (mm) | PCS packing: |        |
|---------|---|--------|--------------|--------|
| YT-2766 | 6 | 100    | 12           | 36/144 |
| YT-2767 | 6 | 150    | 12           | 36/144 |
| YT-2768 | 6 | 200    | 12           | 36/144 |
| YT-2721 | 6 | 300    | 6            | 24/96  |
| YT-2769 | 8 | 150    | 6            | 24/96  |
| YT-2722 | 8 | 200    | 6            | 24/96  |
| YT-2723 | 8 | 250    | 6            | 24/96  |



| YATO    | ⊕    | L (mm) | PCS packing: |        |
|---------|------|--------|--------------|--------|
| YT-2682 | PH00 | 65     | 12           | 96/384 |
| YT-2770 | PH0  | 75     | 12           | 96/384 |
| YT-2771 | PH0  | 100    | 12           | 96/384 |
| YT-2725 | PH0  | 150    | 12           | 60/240 |
| YT-2683 | PH1  | 38     | 12           | 60/240 |
| YT-2772 | PH1  | 75     | 12           | 60/240 |
| YT-2773 | PH1  | 100    | 12           | 60/240 |

| YATO    | ⊕   | L (mm) | PCS packing: |        |
|---------|-----|--------|--------------|--------|
| YT-2774 | PH1 | 150    | 12           | 60/240 |
| YT-2727 | PH1 | 200    | 12           | 36/144 |
| YT-2728 | PH1 | 250    | 6            | 36/144 |
| YT-2729 | PH1 | 300    | 6            | 24/96  |
| YT-2775 | PH2 | 38     | 12           | 60/240 |
| YT-2776 | PH2 | 100    | 12           | 36/144 |
| YT-2777 | PH2 | 150    | 12           | 36/144 |

| YATO    | ⊕   | L (mm) | PCS packing: |        |
|---------|-----|--------|--------------|--------|
| YT-2778 | PH2 | 200    | 12           | 36/144 |
| YT-2730 | PH2 | 250    | 6            | 36/144 |
| YT-2731 | PH2 | 300    | 6            | 24/96  |
| YT-2779 | PH3 | 150    | 6            | 24/96  |
| YT-2732 | PH3 | 200    | 6            | 24/96  |
| YT-2733 | PH3 | 250    | 6            | 24/96  |



| YATO    | ⊕   | L (mm) | PCS packing: |        |
|---------|-----|--------|--------------|--------|
| YT-2686 | PZ0 | 75     | 12           | 96/384 |
| YT-2687 | PZ0 | 100    | 12           | 96/384 |
| YT-2688 | PZ1 | 75     | 12           | 60/240 |

| YATO    | ⊕   | L (mm) | PCS packing: |        |
|---------|-----|--------|--------------|--------|
| YT-2689 | PZ1 | 100    | 12           | 60/240 |
| YT-2690 | PZ1 | 200    | 12           | 36/144 |
| YT-2691 | PZ2 | 100    | 12           | 36/144 |

| YATO    | ⊕   | L (mm) | PCS packing: |        |
|---------|-----|--------|--------------|--------|
| YT-2692 | PZ2 | 150    | 12           | 36/144 |
| YT-2693 | PZ2 | 200    | 12           | 36/144 |
| YT-2694 | PZ3 | 150    | 6            | 24/96  |



| YATO    | ⊗  | L (mm) | PCS packing: |        |
|---------|----|--------|--------------|--------|
| YT-2620 | T5 | 75     | 12           | 96/384 |

| YATO    | ⊗  | L (mm) | PCS packing: |        |
|---------|----|--------|--------------|--------|
| YT-2621 | T6 | 75     | 12           | 96/384 |



| YATO    | ⊗   | L (mm) | PCS packing: |        |
|---------|-----|--------|--------------|--------|
| YT-2622 | T7  | 75     | 12           | 96/384 |
| YT-2623 | T8  | 75     | 12           | 96/384 |
| YT-2624 | T9  | 75     | 12           | 96/384 |
| YT-2625 | T10 | 100    | 12           | 60/240 |

| YATO    | ⊗   | L (mm) | PCS packing: |        |
|---------|-----|--------|--------------|--------|
| YT-2626 | T15 | 100    | 12           | 60/240 |
| YT-2627 | T20 | 100    | 12           | 60/240 |
| YT-2628 | T25 | 100    | 12           | 36/144 |
| YT-2629 | T27 | 100    | 12           | 36/144 |

| YATO    | ⊗   | L (mm) | PCS packing: |        |
|---------|-----|--------|--------------|--------|
| YT-2630 | T30 | 100    | 12           | 36/144 |
| YT-2631 | T40 | 100    | 6            | 24/96  |



GB Screwdriver  
D Schraubendreher  
PL Wkrętak  
RUS Отвёртка  
CZ Šroubovák  
H Csavarhúzó

RO Şurubelniţă  
F Tournevis  
I Cacciavite  
E Destornillador  
CN 螺丝刀

PLASTIC  
HANGER



COLOR BOX

PCS  
packing:



S2

HRC  
58



- application: for deep seated screws, e. g. in power tool casings
- przeznaczanie: do wkrętów głęboko osadzonych, np. w obudowach elektronarzędzi
- cut tip, constant diameter of shaft and tip
- grot frezowany, stała średnica grotu i końcówki

| YATO    | ⊖ | L (mm) | PCS<br>packing: | 📦      |
|---------|---|--------|-----------------|--------|
| YT-2840 | 5 | 150    | 12              | 60/240 |
| YT-2842 | 5 | 250    | 6               | 36/144 |
| YT-2843 | 5 | 300    | 6               | 24/96  |
| YT-2844 | 6 | 150    | 12              | 36/144 |

| YATO    | ⊖ | L (mm) | PCS<br>packing: | 📦      |
|---------|---|--------|-----------------|--------|
| YT-2845 | 6 | 200    | 12              | 36/144 |
| YT-2846 | 6 | 250    | 6               | 36/144 |
| YT-2847 | 6 | 300    | 6               | 24/96  |

GB Go-through screwdriver  
D Schlagschrauber  
PL Wkrętak do pobijania  
RUS Отвёртка-било  
CZ Šroubovák s úderným koncem  
H Beütő csavarhúzó

RO Şurubelniţă pt. fixare  
F Tournevis à frapper  
I Cacciavite  
E Destornillador para dar golpes  
CN 敲击螺丝批

PLASTIC  
HANGER



COLOR BOX

6 PCS



CrV

HRC  
52



| YATO    | ⊖ | L (mm) | PCS<br>packing: | 📦     |
|---------|---|--------|-----------------|-------|
| YT-2699 | 6 | 100    | 6               | 24/96 |
| YT-2700 | 6 | 150    | 6               | 24/96 |
| YT-2701 | 6 | 200    | 6               | 24/96 |
| YT-2702 | 6 | 250    | 6               | 24/96 |

| YATO    | ⊖ | L (mm) | PCS<br>packing: | 📦     |
|---------|---|--------|-----------------|-------|
| YT-2703 | 8 | 150    | 6               | 24/72 |
| YT-2704 | 8 | 200    | 6               | 24/72 |
| YT-2705 | 8 | 250    | 6               | 24/72 |
| YT-2706 | 8 | 300    | 6               | 24/72 |



| YATO    | ⊕   | L (mm) | PCS<br>packing: | 📦     |
|---------|-----|--------|-----------------|-------|
| YT-2708 | PH2 | 100    | 6               | 24/96 |
| YT-2709 | PH2 | 150    | 6               | 24/96 |
| YT-2710 | PH3 | 150    | 6               | 24/72 |

| YATO    | ⊕   | L (mm) | PCS<br>packing: | 📦     |
|---------|-----|--------|-----------------|-------|
| YT-2711 | PH3 | 200    | 6               | 24/72 |
| YT-2712 | PH3 | 250    | 6               | 24/72 |

GB Screwdriver set  
D Schraubendrehersatz  
PL Komplet wkrętaków  
RUS Набор отвёрток

CZ Zámečnické šroubováky  
H Lakatos csavarhózó  
RO Şurubelniţe de lăcătuşerie  
F Set de clés à frapper

I Set cacciavite  
E Juego de destornilladores  
CN 螺丝批组套

2  
PCS



CrV

HRC  
52



DOUBLE  
BLISTER



| YATO    | ⊖ | ⊕   | L (mm)     | 📦    |
|---------|---|-----|------------|------|
| YT-1600 | 6 | PH2 | 150<br>150 | 6/36 |

GB Screwdriver set  
 D Schraubendrehersatz  
 PL Komplet wkręteków  
 RUS Набор отвёрток  
 CZ Zámečnické šroubováky  
 H Lakatos csavarhózó

RO Şurubelnițe de lăcătușerie  
 F Set de tournevis  
 I Set cacciaviti  
 E Juego de destornilladores  
 CN 螺丝批组套

DOUBLE  
 BLISTER



S2

HRC  
 58

5

6  
 PCS

⊖

⊕



| YATO    | ⊖ | ⊕   | L (mm) |      |
|---------|---|-----|--------|------|
| YT-2783 | 3 |     | 75     | 6/24 |
|         | 5 |     | 100    |      |
|         | 6 |     | 100    |      |
|         |   | PH0 | 75     |      |
|         |   | PH1 | 100    |      |
|         |   | PH2 | 100    |      |

8  
 PCS

⊖

⊕



| YATO    | ⊖   | ⊕   | L (mm) |      |
|---------|-----|-----|--------|------|
| YT-2782 | 2.0 |     | 50     | 6/24 |
|         | 2.4 |     | 50     |      |
|         | 6.0 |     | 38     |      |
|         | 6.0 |     | 100    |      |
|         |     | PH0 | 50     |      |
|         |     | PH1 | 50     |      |
|         |     | PH2 | 38     |      |
|         |     | PH2 | 100    |      |

8  
 PCS

⊖

⊕



| YATO    | ⊖ | ⊕   | L (mm) |      |
|---------|---|-----|--------|------|
| YT-2784 | 5 |     | 100    | 6/12 |
|         | 6 |     | 100    |      |
|         | 8 |     | 150    |      |
|         |   | PH0 | 75     |      |
|         |   | PH1 | 100    |      |
|         |   | PH2 | 38     |      |
|         |   | PH2 | 100    |      |
|         |   | PH3 | 150    |      |

12  
 PCS

⊖

⊕

⊗



| YATO    | ⊖ | ⊕   | ⊗   | L (mm) |      |
|---------|---|-----|-----|--------|------|
| YT-2787 | 3 |     |     | 75     | 6/12 |
|         | 5 |     |     | 75     |      |
|         | 6 |     |     | 38     |      |
|         | 6 |     |     | 150    |      |
|         | 8 |     |     | 150    |      |
|         |   | PH0 |     | 75     |      |
|         |   | PH1 |     | 75     |      |
|         |   | PH2 |     | 38     |      |
|         |   | PH2 |     | 100    |      |
|         |   | PH3 |     | 150    |      |
|         |   |     | SQ1 | 100    |      |
|         |   |     | SQ2 | 100    |      |

15  
 PCS

⊖

⊕

⊗



| YATO    | ⊖   | ⊕    | ⊗  | L (mm) |      |
|---------|-----|------|----|--------|------|
| YT-2788 | 1.5 |      |    | 50     | 6/24 |
|         | 2.0 |      |    | 50     |      |
|         | 5.0 |      |    | 75     |      |
|         | 6.0 |      |    | 38     |      |
|         | 6.0 |      |    | 100    |      |
|         | 6.0 |      |    | 125    |      |
|         |     | PH00 |    | 50     |      |
|         |     | PH0  |    | 50     |      |
|         |     | PH1  |    | 75     |      |
|         |     | PH2  |    | 38     |      |
|         |     | PH2  |    | 100    |      |
|         |     |      | T5 | 50     |      |
|         |     |      | T6 | 50     |      |
|         |     |      | T7 | 50     |      |
|         |     |      | T8 | 50     |      |



GB 6 in 1 interchangeable screwdriver set  
D Umsteckschraubendreher  
PL Wkrętak z końcówkami dwustronnymi  
RUS Отвёртка с двухсторонними насадками  
CZ Šroubovák lancer  
z dvoustrannou koncovkou  
H Csavarhúzó kétvégű szárral  
RO Şurubelniţă cu dublu capăt  
F Tournevis embouts réversibles  
I Cacciavite reversibile  
E Destornillador con punta de dos caras  
CN 6合1螺丝批组套



5.0 mm PH1  
6.0 mm PH2  
6 8 mm  
MAGNETIC TIP  
S2



DOUBLE BLISTER

**YATO**  
YT-2781 12/96

GB Screwdriver set  
D Schraubendrehersatz  
PL Komplet wkrętaków  
RUS Набор отвёрток  
CZ Zámečnické šroubováky  
H Lakatos csavarhózá  
RO Şurubelniţe de lăcătuşerie  
F Set de tournevis  
I Set cacciaviti  
E Juego de destornilladores  
CN 螺丝批组套

S2 HRC 58



PLASTIC HANGER & DOUBLE BLISTER

1/4" (6.3 mm): 5, 8 mm (L=25 mm);  
1/4" (6.3 mm): PH1, PH2, PH3 (L=25 mm);  
1/4" (6.3 mm): T10, T15 (L=25 mm);  
1/4" (6.3 mm): 4, 5, 6 mm (L=25 mm)

DOUBLE BLISTER

9 PCS

PLASTIC HANGER

18 PCS

27 PCS

| YATO    | ⊖ | ⊕   | L (mm) |      |
|---------|---|-----|--------|------|
| YT-2785 | 3 |     | 75     | 6/12 |
|         | 5 |     | 75     |      |
|         | 6 |     | 100    |      |
|         | 6 |     | 150    |      |
|         | 8 |     | 150    |      |
|         |   | PH0 | 75     |      |
|         |   | PH1 | 75     |      |
|         |   | PH2 | 100    |      |
|         |   | PH2 | 150    |      |
|         |   |     |        |      |

| YATO    | ⊖   | ⊕    | ⊗  | L (mm) |      |
|---------|-----|------|----|--------|------|
| YT-2786 | 2.4 |      |    | 50     | 6/12 |
|         | 3.0 |      |    | 50     |      |
|         | 5.0 |      |    | 75     |      |
|         | 6.0 |      |    | 38     |      |
|         | 6.0 |      |    | 100    |      |
|         | 8.0 |      |    | 150    |      |
|         |     | PH00 |    | 50     |      |
|         |     | PH0  |    | 50     |      |
|         |     | PH1  |    | 75     |      |
|         |     | PH2  |    | 38     |      |
|         |     | PH2  |    | 100    |      |
|         |     | PH3  |    | 150    |      |
|         |     |      | T5 | 50     |      |
|         |     |      | T6 | 50     |      |
|         |     |      | T7 | 50     |      |
|         |     |      | T8 | 50     |      |
|         |     | T9   | 50 |        |      |
|         |     | T10  | 50 |        |      |

| YATO    | ⊖   | ⊕    | L (mm) |      |
|---------|-----|------|--------|------|
| YT-2789 | 2.0 |      | 50     | 2/10 |
|         | 2.4 |      | 50     |      |
|         | 3.0 |      | 75     |      |
|         | 5.0 |      | 75     |      |
|         | 6.0 |      | 38     |      |
|         | 6.0 |      | 100    |      |
|         | 8.0 |      | 150    |      |
|         |     | PH00 | 50     |      |
|         |     | PH0  | 50     |      |
|         |     | PH0  | 75     |      |
|         |     | PH1  | 75     |      |
|         |     | PH2  | 38     |      |
|         |     | PH2  | 100    |      |
|         |     | PH3  | 150    |      |

GB Mini pick & hook set  
D Mini hacken set  
PL Zestaw haczyków z rękojmią  
RUS Набор ключков с рукоятками  
CZ Sada háčkových mini páčidel  
H Mini ár és kampó készlet  
RO Mini-set pt. extras garnituri  
F Set de crochets  
I Set ganci con maniglia  
E Juego de palancas de hierro  
CN 迷你拉拔器组套

4 PCS HRC 40



SLIDING CARD

**YATO**  
YT-0843 12/72



- GB Precision screwdriver set
- D Präzisions-Feinmechanikersatz
- PL Zestaw wkrętek precyzyjnych
- RUS Набор прецизионных отвёрток
- CZ Šroubováky sada pro jemnou mechaniku
- H Órás csavarhúzó készlet
- RO Set surubelnite
- F Set de tournevis de précision
- I Set cacciavite di precisione
- E Destornilladores precisos
- CN 螺丝批组套



PLASTIC BOX & DOUBLE BLISTER



6 PCS



HRC 58

| YATO    | ⊖   | ⊕    | L (mm) |       |
|---------|-----|------|--------|-------|
| YT-2790 | 1.4 |      | 50     | 15/60 |
|         | 2.0 |      | 50     |       |
|         | 2.4 |      | 50     |       |
|         |     | PH00 | 50     |       |
|         |     | PH0  | 50     |       |
|         |     | PH1  | 50     |       |



S2

6 PCS



HRC 58

| YATO    | ⊕   | L (mm) |       |
|---------|-----|--------|-------|
| YT-2791 | T5  | 50     | 15/60 |
|         | T6  | 50     |       |
|         | T7  | 50     |       |
|         | T8  | 50     |       |
|         | T9  | 50     |       |
|         | T10 | 50     |       |



6 PCS



7 PCS



HRC 58

| YATO    | ⊕   | L (mm) |      |
|---------|-----|--------|------|
| YT-2576 | T5  | 40     | 6/36 |
|         | T6  | 40     |      |
|         | T7  | 40     |      |
|         | T8  | 40     |      |
|         | T9  | 40     |      |
|         | T10 | 40     |      |

| YATO    | ⊖   | ⊕    | ⊗  | L (mm) |      |
|---------|-----|------|----|--------|------|
| YT-2795 | 2.4 |      |    | 40     | 6/36 |
|         | 3.0 |      |    | 40     |      |
|         |     | PH00 |    | 40     |      |
|         |     | PH0  |    | 40     |      |
|         |     |      | T6 | 40     |      |
|         |     |      | T7 | 40     |      |
|         |     |      | T8 | 40     |      |
|         |     |      |    | 40     |      |

7 PCS



| YATO    | ⊖   | ⊕    | ⊗   | L (mm) |      |
|---------|-----|------|-----|--------|------|
| YT-2577 | 2.4 |      |     | 40     | 6/36 |
|         | 3.0 |      |     | 40     |      |
|         |     | PH00 |     | 40     |      |
|         |     | PH0  |     | 40     |      |
|         |     |      | T8  | 40     |      |
|         |     |      | T9  | 40     |      |
|         |     |      | T10 | 40     |      |
|         |     |      |     | 40     |      |

- GB Long precision screwdriver set
- D Präzisions-Feinmechanikersatz
- PL Zestaw wkrętek precyzyjnych długich
- RUS Набор прецизионных отвёрток
- CZ Šroubováky sada pro jemnou mechaniku
- H Órás csavarhúzó készlet
- RO Set surubelnite
- F Set de tournevis
- I Set cacciavite di precisione
- E Destornilladores precisos
- CN 长钟表螺丝批组套



6 PCS



S2



SLIDING CARD



| YATO    | ⊖   | ⊕    | L (mm) |        |
|---------|-----|------|--------|--------|
| YT-2575 | 2.5 |      | 150    | 12/120 |
|         | 3.0 |      | 150    |        |
|         | 3.5 |      | 150    |        |
|         |     | PH00 | 150    |        |
|         |     | PH0  | 150    |        |
|         |     | PH1  | 150    |        |



GB Screwdriver  
D Schraubendreher  
PL Wkrętak  
RUS Отвертка  
CZ Šroubovák  
H Csavarhúzó

RO Șurubelniță  
F Tournevis  
I Cacciavite  
E Destornillador  
CN 螺丝刀

PLASTIC  
HANGER



PCS  
packing:



COLOR BOX





S2



HRC  
58





| YATO  | ⊖ | L (mm) | PCS<br>packing: |  |
|--|---|--------|-----------------|---|
| YT-25900   | 2 | 75     | 12              | 96/384  |
| YT-25901   | 3 | 75     | 12              | 96/384  |
| YT-25902   | 3 | 100    | 12              | 96/384  |
| YT-25903   | 3 | 150    | 12              | 60/240  |
| YT-25904   | 4 | 100    | 12              | 96/384  |
| YT-25905   | 4 | 150    | 12              | 96/384  |
| YT-25906   | 4 | 200    | 12              | 96/384  |
| YT-25907   | 5 | 75     | 12              | 60/240  |



| YATO  | ⊖ | L (mm) | PCS<br>packing: |  |
|--|---|--------|-----------------|---|
| YT-25908   | 5 | 100    | 12              | 60/240  |
| YT-25909   | 5 | 150    | 12              | 60/240  |
| YT-25910   | 6 | 38     | 12              | 60/240  |
| YT-25911   | 6 | 100    | 12              | 36/144  |
| YT-25912   | 6 | 150    | 12              | 36/144  |
| YT-25913   | 6 | 200    | 12              | 36/144  |
| YT-25914   | 8 | 150    | 6               | 24/96   |





| YATO  | ⊕   | L (mm) | PCS<br>packing: |  |
|--|-----|--------|-----------------|---|
| YT-25920   | PH0 | 75     | 12              | 96/384  |
| YT-25921   | PH0 | 100    | 12              | 96/384  |
| YT-25922   | PH1 | 38     | 12              | 60/240  |
| YT-25923   | PH1 | 75     | 12              | 60/240  |
| YT-25924   | PH1 | 100    | 12              | 60/240  |
| YT-25925   | PH1 | 150    | 12              | 60/240  |
| YT-25926   | PH1 | 200    | 12              | 36/144  |
| YT-25927   | PH1 | 300    | 6               | 24/96   |

| YATO  | ⊕   | L (mm) | PCS<br>packing: |  |
|--|-----|--------|-----------------|---|
| YT-25928   | PH2 | 38     | 12              | 60/240  |
| YT-25929   | PH2 | 100    | 12              | 36/144  |
| YT-25930   | PH2 | 150    | 12              | 36/144  |
| YT-25931   | PH2 | 200    | 12              | 36/144  |
| YT-25932   | PH2 | 300    | 6               | 24/96   |
| YT-25933   | PH3 | 150    | 6               | 24/96   |
| YT-25934   | PH3 | 200    | 6               | 24/96   |



| YATO  | ⊕   | L (mm) | PCS<br>packing: |  |
|--|-----|--------|-----------------|---|
| YT-25940   | PZ1 | 75     | 12              | 60/240  |
| YT-25941   | PZ1 | 100    | 12              | 60/240  |



| YATO  | ⊕   | L (mm) | PCS<br>packing: |  |
|--|-----|--------|-----------------|---|
| YT-25942   | PZ2 | 100    | 12              | 36/144  |
| YT-25943   | PZ2 | 150    | 12              | 36/144  |





| YATO  | ⊗  | L (mm) | PCS<br>packing: |  |
|--|----|--------|-----------------|---|
| YT-25950   | T5 | 75     | 12              | 96/384  |

| YATO  | ⊗  | L (mm) | PCS<br>packing: |  |
|--|----|--------|-----------------|---|
| YT-25951   | T6 | 75     | 12              | 96/384  |



| YATO  | ⊗   | L (mm) | PCS<br>packing: |  |
|--|-----|--------|-----------------|---|
| YT-25952   | T7  | 75     | 12              | 96/384  |
| YT-25953   | T8  | 75     | 12              | 96/384  |
| YT-25954   | T9  | 75     | 12              | 96/384  |
| YT-25955   | T10 | 100    | 12              | 60/240  |
| YT-25956   | T15 | 100    | 12              | 60/240  |

| YATO  | ⊗   | L (mm) | PCS<br>packing: |  |
|--|-----|--------|-----------------|---|
| YT-25957   | T20 | 100    | 12              | 60/240  |
| YT-25958   | T25 | 100    | 12              | 36/144  |
| YT-25959   | T27 | 100    | 12              | 36/144  |
| YT-25960   | T30 | 100    | 12              | 36/144  |
| YT-25961   | T40 | 100    | 6               | 24/96   |

GB Go-through screwdriver  
 D Schlagschrauber  
 PL Wkrętek do robienia  
 RUS Отвёртка-било  
 CZ Šroubovák  
 s úderným koncem  
 H Beütő csavarhúzó

RO Şurubelniţă pt. fixare  
 F Tournevis à frapper  
 I Cacciaviti per viti  
 con intaglio  
 E Destornillador  
 para dar golpes  
 CN 敲击螺丝批

PLASTIC  
 HANGER



6 PCS

COLOR BOX



CrV  
 6150

HRC  
 52



| YATO     | ⊖ | L (mm) | PCS<br>packing | 📦     |
|----------|---|--------|----------------|-------|
| YT-25985 | 6 | 100    | 6              | 24/96 |
| YT-25986 | 6 | 150    | 6              | 24/96 |
| YT-25987 | 6 | 200    | 6              | 24/96 |
| YT-25988 | 6 | 250    | 6              | 24/96 |
| YT-25989 | 8 | 150    | 6              | 24/72 |
| YT-25990 | 8 | 200    | 6              | 24/72 |
| YT-25991 | 8 | 250    | 6              | 24/72 |
| YT-25992 | 8 | 300    | 6              | 24/72 |

| YATO     | ⊕   | L (mm) | PCS<br>packing | 📦     |
|----------|-----|--------|----------------|-------|
| YT-25993 | PH2 | 100    | 6              | 24/96 |
| YT-25994 | PH2 | 150    | 6              | 24/96 |
| YT-25995 | PH3 | 150    | 6              | 24/72 |
| YT-25996 | PH3 | 200    | 6              | 24/72 |
| YT-25997 | PH3 | 250    | 6              | 24/72 |

GB Screwdriver set  
 D Schraubendrehersatz  
 PL Komplet wkręteków  
 RUS Набор отвёрток  
 CZ Zámečnické šroubováky  
 H Lakatos csavarhúzó  
 RO Şurubelniţe de lăcătuşerie  
 F Set de tournevis  
 I Set cacciaviti  
 E Juego de destornilladores  
 CN 螺丝批组套

2  
 PCS



CrV  
 6150

HRC  
 52



DOUBLE  
 BLISTER



| YATO     | ⊖ | ⊕   | L (mm) | 📦    |
|----------|---|-----|--------|------|
| YT-25998 | 6 |     | 150    | 6/36 |
|          |   | PH2 | 150    |      |

GB Screwdriver set  
 D Schraubendrehersatz  
 PL Komplet wkręteków  
 RUS Набор отвёрток  
 CZ Zámečnické šroubováky  
 H Lakatos csavarhúzó

RO Şurubelniţe de lăcătuşerie  
 F Set de tournevis  
 I Set cacciaviti  
 E Juego de destornilladores  
 CN 螺丝批组套

DOUBLE  
 BLISTER



S2

HRC  
 58



6  
 PCS



| YATO     | ⊖   | ⊕   | L (mm) | 📦    |
|----------|-----|-----|--------|------|
| YT-25965 | 3.0 |     | 75     | 6/24 |
|          | 5.0 |     | 100    |      |
|          | 6.0 |     | 100    |      |
|          |     | PH0 | 75     |      |
|          |     | PH1 | 100    |      |
|          |     | PH2 | 100    |      |



8  
 PCS



| YATO     | ⊖   | ⊕   | L (mm) | 📦    |
|----------|-----|-----|--------|------|
| YT-25980 | 2.0 |     | 50     | 6/24 |
|          | 2.4 |     | 50     |      |
|          | 6.0 |     | 38     |      |
|          | 6.0 |     | 100    |      |
|          |     | PH0 | 50     |      |
|          |     | PH1 | 50     |      |
|          |     | PH2 | 38     |      |
|          |     | PH2 | 100    |      |



GB Screwdriver set  
D Schraubendrehersatz  
PL Komplet wkrętaków  
RUS Набор отвёрток  
CZ Zámečnické šroubováky  
H Lakatos csavarhúzó

RO Șurubelnițe de lăcătușerie  
F Set de tournevis  
I Set cacciaviti  
E Juego de destornilladores  
CN 螺丝批组套

DOUBLE  
BLISTER



S2

HRC  
58



8  
PCS



12  
PCS



| YATO     | ⊖   | ⊕   | L (mm) |      |
|----------|-----|-----|--------|------|
| YT-25966 | 5.0 |     | 100    | 6/12 |
|          | 6.0 |     | 100    |      |
|          | 8.0 |     | 150    |      |
|          |     | PH0 | 75     |      |
|          |     | PH1 | 100    |      |
|          |     | PH2 | 38     |      |
|          |     | PH2 | 100    |      |
|          |     | PH3 | 150    |      |

| YATO     | ⊖   | ⊕   | ⊗   | L (mm) |      |
|----------|-----|-----|-----|--------|------|
| YT-25967 | 3.0 |     |     | 75     | 6/12 |
|          | 5.0 |     |     | 75     |      |
|          | 6.0 |     |     | 38     |      |
|          | 6.0 |     |     | 150    |      |
|          | 8.0 |     |     | 150    |      |
|          |     | PH0 |     | 75     |      |
|          |     | PH1 |     | 75     |      |
|          |     | PH2 |     | 38     |      |
|          |     | PH2 |     | 100    |      |
|          |     | PH3 |     | 150    |      |
|          |     | SQ1 | 100 |        |      |
|          |     | SQ2 | 100 |        |      |



15  
PCS



| YATO     | ⊖   | ⊕    | ⊗  | L (mm) |      |
|----------|-----|------|----|--------|------|
| YT-25981 | 1.5 |      |    | 50     | 6/24 |
|          | 2.0 |      |    | 50     |      |
|          | 5.0 |      |    | 75     |      |
|          | 6.0 |      |    | 38     |      |
|          | 6.0 |      |    | 100    |      |
|          | 6.0 |      |    | 125    |      |
|          |     | PH00 |    | 50     |      |
|          |     | PH0  |    | 50     |      |
|          |     | PH1  |    | 75     |      |
|          |     | PH2  |    | 38     |      |
|          |     | PH2  |    | 100    |      |
|          |     |      | T5 | 50     |      |
|          |     |      | T6 | 50     |      |
|          |     |      | T7 | 50     |      |
|          |     | T8   | 50 |        |      |

GB 6 in 1 interchangeable screwdriver set  
D Umsteckschraubendreher  
PL Wkrętak z końcówkami dwustronnymi  
RUS Отвёртка с двухсторонними насадками  
CZ Šroubovák lancr z dvoustrannou koncovkou  
H Csavarhúzó kétvégű szárral  
RO Șurubelniță cu dublu capăt  
F Tournevis embouts réversibles  
I Cacciavite reversibile  
E Destornillador con punta de dos caras  
CN 6合1螺丝批组套



⊖ 5.0 mm  
⊕ PH1

⊖ 6.0 mm  
⊕ PH2

1/4"  
(6.3 mm)  
5/16"  
(8 mm)

MAGNETIC  
TIP

S2

DOUBLE  
BLISTER



YATO

YT-25971

12/96

GB Screwdriver set  
 D Schraubendrehersatz  
 PL Komplet wkręteków  
 RUS Набор отвёрток

CZ Zámečnické šroubováky  
 H Lakatos csavarhózó  
 RO Şurubelniţe de lăcătuşerie  
 F Set de tournevis

I Set cacciaviti  
 E Juego de destornilladores  
 CN 螺丝批组套



S2

HRC 58

5

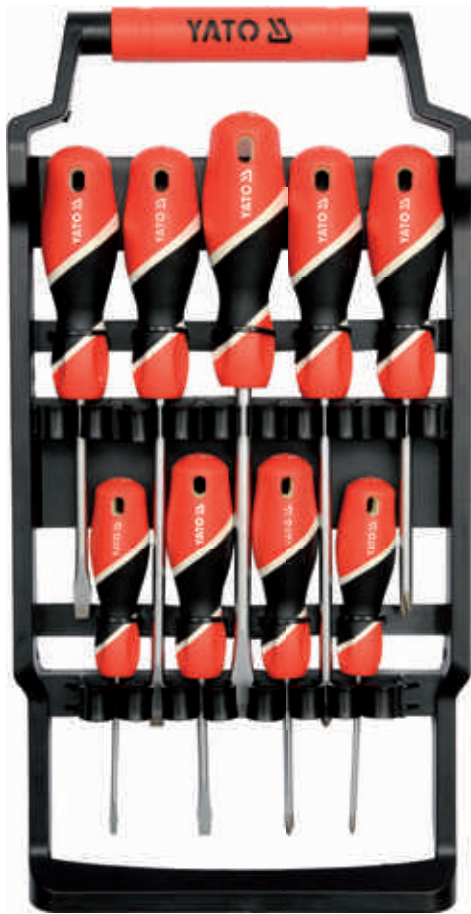

9 PCS



PLASTIC HANGER



| YATO     | ⊖   | ⊕   | L (mm) |      |
|----------|-----|-----|--------|------|
| YT-25968 | 3.0 |     | 75     | 6/12 |
|          | 5.0 |     | 75     |      |
|          | 6.0 |     | 100    |      |
|          | 6.0 |     | 150    |      |
|          | 8.0 |     | 150    |      |
|          |     | PH0 | 75     |      |
|          |     | PH1 | 75     |      |
|          |     | PH2 | 100    |      |
|          |     | PH2 | 150    |      |
|          |     |     |        |      |



18 PCS



PLASTIC HANGER & DOUBLE BLISTER



| YATO     | ⊖   | ⊕    | ★  | L (mm) |      |
|----------|-----|------|----|--------|------|
| YT-25982 | 2.4 |      |    | 50     | 6/12 |
|          | 3.0 |      |    | 50     |      |
|          | 5.0 |      |    | 75     |      |
|          | 6.0 |      |    | 38     |      |
|          | 6.0 |      |    | 100    |      |
|          | 8.0 |      |    | 150    |      |
|          |     | PH00 |    | 50     |      |
|          |     | PH0  |    | 50     |      |
|          |     | PH1  |    | 75     |      |
|          |     | PH2  |    | 38     |      |
|          |     | PH2  |    | 100    |      |
|          |     | PH3  |    | 150    |      |
|          |     |      | T5 | 50     |      |
|          |     |      | T6 | 50     |      |
|          |     |      | T7 | 50     |      |
|          |     |      | T8 | 50     |      |
|          |     | T9   | 50 |        |      |
|          |     | T10  | 50 |        |      |



GB Screwdriver CZ Šroubovák I Cacciavite  
D Schraubendreher H Csavarhúzó E Destornillador  
PL Wkrętak RO Șurubelniță CN 螺丝刀  
RUS Отвёртка F Tournevis

COLOR BOX

**SVCM55**



- application: industry
- can be used as go-through
- special highest quality alloy steel
- przeznaczenie: przemysł
- możliwość pobijania
- stal wysokostopowa



| YATO    | ⊖   | L (mm) | PCS packing | ☐   |
|---------|-----|--------|-------------|-----|
| YT-2601 | 3.0 | 75     | 12          | 240 |
| YT-2606 | 4.0 | 100    | 12          | 240 |
| YT-2608 | 5.5 | 100    | 12          | 240 |
| YT-2609 | 5.5 | 150    | 12          | 240 |
| YT-2610 | 5.5 | 200    | 12          | 240 |
| YT-2612 | 6.5 | 38     | 12          | 240 |
| YT-2613 | 6.5 | 100    | 12          | 240 |
| YT-2614 | 6.5 | 150    | 12          | 240 |
| YT-2615 | 6.5 | 200    | 12          | 240 |
| YT-2618 | 8.0 | 150    | 6           | 120 |

| YATO    | ⊖   | L (mm) | PCS packing | ☐   |
|---------|-----|--------|-------------|-----|
| YT-2602 | 3.0 | 100    | 12          | 240 |
| YT-2633 | 3.0 | 300    | 12          | 240 |
| YT-2603 | 4.0 | 38     | 12          | 240 |
| YT-2604 | 4.0 | 75     | 12          | 240 |
| YT-2607 | 4.0 | 150    | 12          | 240 |
| YT-2634 | 4.0 | 400    | 12          | 240 |
| YT-2635 | 5.0 | 300    | 12          | 120 |
| YT-2636 | 5.0 | 400    | 12          | 120 |
| YT-2619 | 8.0 | 200    | 6           | 120 |

- application: industry
- can be used as go-through
- special highest quality alloy steel
- przeznaczenie: przemysł
- możliwość pobijania
- stal wysokostopowa



| YATO    | ⊕   | L (mm) | PCS packing | ☐   |
|---------|-----|--------|-------------|-----|
| YT-2640 | PH0 | 75     | 12          | 240 |
| YT-2642 | PH1 | 75     | 12          | 240 |
| YT-2643 | PH1 | 100    | 12          | 240 |
| YT-2644 | PH1 | 150    | 12          | 240 |
| YT-2645 | PH1 | 200    | 12          | 240 |
| YT-2647 | PH2 | 38     | 12          | 240 |
| YT-2648 | PH2 | 100    | 12          | 240 |
| YT-2649 | PH2 | 150    | 12          | 240 |
| YT-2650 | PH2 | 200    | 12          | 240 |
| YT-2653 | PH3 | 150    | 6           | 120 |

| YATO    | ⊕   | L (mm) | PCS packing | ☐   |
|---------|-----|--------|-------------|-----|
| YT-2637 | PH0 | 300    | 12          | 240 |
| YT-2641 | PH1 | 38     | 12          | 240 |
| YT-2638 | PH1 | 400    | 12          | 120 |
| YT-2639 | PH2 | 400    | 12          | 120 |

- application: industry
- can be used as go-through
- special highest quality alloy steel
- przeznaczenie: przemysł
- możliwość pobijania
- stal wysokostopowa



| YATO    | ⊕   | L (mm) | PCS packing | ☐   |
|---------|-----|--------|-------------|-----|
| YT-2661 | PZ0 | 75     | 12          | 240 |
| YT-2663 | PZ1 | 100    | 12          | 240 |
| YT-2665 | PZ2 | 150    | 12          | 240 |
| YT-2667 | PZ3 | 150    | 6           | 240 |

| YATO    | ⊕   | L (mm) | PCS packing | ☐   |
|---------|-----|--------|-------------|-----|
| YT-2656 | PZ0 | 300    | 12          | 240 |
| YT-2654 | PZ1 | 38     | 12          | 240 |
| YT-2657 | PZ1 | 400    | 12          | 120 |
| YT-2655 | PZ2 | 38     | 12          | 240 |
| YT-2658 | PZ2 | 400    | 12          | 120 |

- application: industry
- can be used as go-through
- special highest quality alloy steel
- przeznaczenie: przemysł
- możliwość pobijania
- stal wysokostopowa



| YATO    | ⊗  | L (mm) | PCS packing | ☐   |
|---------|----|--------|-------------|-----|
| YT-2741 | T5 | 75     | 12          | 240 |
| YT-2742 | T6 | 75     | 12          | 240 |

| YATO    | ⊗   | L (mm) | PCS packing | ☐   |
|---------|-----|--------|-------------|-----|
| YT-2743 | T7  | 75     | 12          | 240 |
| YT-2744 | T8  | 75     | 12          | 240 |
| YT-2745 | T9  | 75     | 12          | 240 |
| YT-2746 | T10 | 100    | 12          | 240 |
| YT-2748 | T15 | 100    | 12          | 240 |
| YT-2750 | T20 | 100    | 12          | 240 |
| YT-2752 | T25 | 100    | 12          | 240 |
| YT-2753 | T27 | 100    | 12          | 240 |
| YT-2754 | T30 | 100    | 12          | 240 |
| YT-2756 | T40 | 100    | 12          | 240 |

| YATO    | ⊗   | L (mm) | PCS packing | ☐   |
|---------|-----|--------|-------------|-----|
| YT-2757 | T45 | 100    | 12          | 240 |

GB Screwdriver set  
 D Schraubendrehersatz  
 PL Komplet wkręteków  
 RUS Набор отвёрток  
 CZ Zámečnické šroubováky  
 H Lakatos csavarhózó

RO Şurubelnițe de lăcătușerie  
 F Set de tournevis  
 I Set cacciaviti  
 E Juego de destornilladores  
 CN 螺丝批组套

DOUBLE  
BLISTER





SVC55

HRC 58-62





6 PCS  

| YATO  | ⊖   | ⊕   | L (mm) |  |
|--|-----|-----|--------|---|
| YT-2668  | 5.5 |     | 100    | 6/24  |
|  | 6.5 |     | 100    |   |
|  | 8.0 |     | 150    |   |
|  |     | PH1 | 100    |   |
|  |     | PH2 | 100    |   |
|  |     | PH3 | 150    |   |





7 PCS   

| YATO  | ⊖   | ⊕   | ⊕   | L (mm) |  |
|---|-----|-----|-----|--------|---|
| YT-2669   | 5.5 |     |     | 100    | 4/16  |
|   | 6.5 |     |     | 38     |   |
|   | 6.5 |     |     | 150    |   |
|   |     | PH1 |     | 100    |   |
|   |     | PH2 |     | 150    |   |
|   |     |     | PZ1 | 100    |   |
|   |     | PZ2 | 150 |        |   |



8 PCS  

| YATO  | ⊖   | ⊕   | L (mm) |  |
|---|-----|-----|--------|---|
| YT-2670   | 4.0 |     | 100    | 4/16  |
|   | 5.5 |     | 100    |   |
|   | 6.5 |     | 38     |   |
|   | 6.5 |     | 100    |   |
|   |     | PH0 | 75     |   |
|   |     | PH1 | 100    |   |
|   |     | PH2 | 38     |   |
|   |     | PH2 | 100    |   |



GB Precision screwdriver  
D Präzisions-Schraubendreher  
PL Wkrętak precyzyjny  
RUS Отвёртка для точных работ

CZ Šroubovák pro jemnou mechaniku  
H Műszerész csavarhúzó  
RO Șurubelniță mecanica fina  
F Tournevis de précision

I Cacciavite di precisione  
E Destornillador de precisión  
CN 螺丝批

S2

HRC  
57-61



| YATO     | ⊖   | L (mm) |  |
|----------|-----|--------|---|
| YT-25802 | 1.4 | 50     | 50/400  |
| YT-25803 | 1.6 | 50     | 50/400  |
| YT-25804 | 1.8 | 50     | 50/400  |
| YT-25805 | 2.0 | 50     | 50/400  |
| YT-25806 | 2.0 | 75     | 50/400  |
| YT-25807 | 2.4 | 50     | 50/400  |
| YT-25808 | 2.4 | 75     | 50/400  |
| YT-25809 | 3.0 | 50     | 50/400  |
| YT-25810 | 3.0 | 75     | 50/400  |
| YT-25811 | 3.0 | 100    | 50/400  |

| YATO     | ⊕     | L (mm) |  |
|----------|-------|--------|---|
| YT-25831 | PH000 | 50     | 50/400  |
| YT-25832 | PH000 | 75     | 50/400  |
| YT-25833 | PH00  | 50     | 50/400  |
| YT-25834 | PH00  | 75     | 50/400  |
| YT-25835 | PH0   | 50     | 50/400  |
| YT-25836 | PH0   | 75     | 50/400  |
| YT-25837 | PH0   | 100    | 50/400  |
| YT-25838 | PH1   | 50     | 50/400  |
| YT-25839 | PH1   | 100    | 50/400  |
| YT-25840 | PH1   | 150    | 50/400  |



| YATO     | ⊕   | L (mm) |  |
|----------|-----|--------|--|
| YT-25841 | PZ0 | 50     | 50/400   |
| YT-25842 | PZ0 | 75     | 50/400   |
| YT-25843 | PZ0 | 100    | 50/400   |
| YT-25844 | PZ1 | 50     | 50/400   |
| YT-25845 | PZ1 | 100    | 50/400   |
| YT-25846 | PZ1 | 150    | 50/400   |

| YATO     | ⊗   | L (mm) |  |
|----------|-----|--------|--|
| YT-25852 | T5  | 50     | 50/400   |
| YT-25853 | T6  | 50     | 50/400   |
| YT-25854 | T7  | 50     | 50/400   |
| YT-25855 | T8  | 50     | 50/400   |
| YT-25856 | T9  | 50     | 50/400   |
| YT-25857 | T10 | 50     | 50/400   |

GB Precision screwdriver set  
D Präzisions-Feinmechanikersatz  
PL Zestaw wkrętaków precyzyjnych  
RUS Набор прецизионных отвёрток  
CZ Šroubováky sada pro jemnou mechaniku

H Órás csavarhúzó készlet  
RO Set surubelnite  
F Set de tournevis de précision  
I Set cacciavite di precisione  
E Destornilladores precisos  
CN 螺丝批组套

PLASTIC BOX  
& DOUBLE  
BLISTER



S2

HRC  
57-61



6  
PCS





6  
PCS



7  
PCS



| YATO     | ⊖   | ⊕    | L (mm) |  |
|----------|-----|------|--------|---|
| YT-25861 | 1.4 |      | 50     | 6/36  |
|          | 2.0 |      | 50     |   |
|          | 2.4 |      | 50     |   |
|          |     | PH00 | 50     |   |
|          |     | PH0  | 50     |   |
|          |     | PH1  | 50     |   |

| YATO     | ⊗   | L (mm) |  |
|----------|-----|--------|---|
| YT-25862 | T5  | 50     | 6/36  |
|          | T6  | 50     |   |
|          | T7  | 50     |   |
|          | T8  | 50     |   |
|          | T9  | 50     |   |
|          | T10 | 50     |   |

| YATO     | ⊖   | ⊕    | ⊗  | L (mm) |  |
|----------|-----|------|----|--------|---|
| YT-25863 | 2.0 |      |    | 50     | 6/36  |
|          | 3.0 |      |    | 50     |   |
|          |     | PH00 |    | 50     |   |
|          |     | PH0  |    | 50     |   |
|          |     |      | T5 | 50     |   |
|          |     |      | T6 | 50     |   |
|          |     |      | T7 | 50     |   |

GB Insulated screwdriver  
 D Isolierte Schraubendreher  
 PL Wkrętek izolowany  
 RUS Изолированная отвёртка  
 CZ Izolovaný šroubovák  
 H Szigetelt csavarhúzó

RO Şurubelniţă izolată  
 F Tournevis isolé  
 I Cacciavite isolato  
 E Destornillador aislado  
 CN 绝缘螺丝批

PLASTIC HANGER



1000 V S2 HRC 56-60



• application: industry • przeznaczenie: przemysł  
 • VDE certificate • certyfikat VDE

| YATO    | ⊖   | L (mm) | ☐      |
|---------|-----|--------|--------|
| YT-2815 | 3.0 | 75     | 12/120 |
| YT-2816 | 4.0 | 75     | 12/120 |
| YT-2817 | 4.0 | 100    | 12/120 |

| YATO    | ⊖   | L (mm) | ☐      |
|---------|-----|--------|--------|
| YT-2818 | 5.5 | 125    | 12/120 |
| YT-2819 | 6.5 | 150    | 12/120 |
| YT-2820 | 8.0 | 175    | 12/120 |



• application: industry • przeznaczenie: przemysł  
 • VDE certificate • certyfikat VDE

| YATO    | ⊕   | L (mm) | ☐      |
|---------|-----|--------|--------|
| YT-2821 | PH0 | 60     | 12/120 |
| YT-2822 | PH1 | 80     | 12/120 |

| YATO    | ⊕   | L (mm) | ☐      |
|---------|-----|--------|--------|
| YT-2823 | PH2 | 100    | 12/120 |
| YT-2824 | PH3 | 150    | 12/120 |



• application: industry • przeznaczenie: przemysł  
 • VDE certificate • certyfikat VDE

| YATO    | ⊕   | L (mm) | ☐      |
|---------|-----|--------|--------|
| YT-2825 | PZ1 | 80     | 12/120 |

| YATO    | ⊕   | L (mm) | ☐      |
|---------|-----|--------|--------|
| YT-2826 | PZ2 | 100    | 12/120 |

GB Insulated screwdriver set  
 D Isolierte Schraubendrehersatz  
 PL Komplet wkrętek izolowanych  
 RUS Изолированная отвёртка - набор  
 CZ Izolované šroubováky  
 H Szigetelt csavarhúzó

RO Şurubelniţă izolată  
 F Set de tournevis isolés  
 I Set di cacciavite isolato  
 E Juego de destornilladores aislado  
 CN 绝缘螺丝批组套

DOUBLE BLISTER



1000 V S2 HRC 56-60



5 PCS



• application: industry • przeznaczenie: przemysł  
 • VDE certificate • certyfikat VDE

| YATO    | ⊖   | ⊕   | L (mm) | ☐     |
|---------|-----|-----|--------|-------|
| YT-2827 | 3.0 |     | 75     | 20/40 |
|         | 4.0 |     | 100    |       |
|         | 5.5 |     | 125    |       |
|         |     | PH1 | 80     |       |
|         |     | PH2 | 100    |       |



7 PCS



• application: industry • przeznaczenie: przemysł  
 • VDE certificate • certyfikat VDE

| YATO    | ⊖   | ⊕   | ⊕   | L (mm) | ☐     |
|---------|-----|-----|-----|--------|-------|
| YT-2828 | 3.0 |     |     | 75     | 20/40 |
|         | 4.0 |     |     | 100    |       |
|         | 5.5 |     |     | 125    |       |
|         |     | PH1 |     | 80     |       |
|         |     | PH2 |     | 100    |       |
|         |     |     | PZ1 | 80     |       |
|         |     |     | PZ2 | 100    |       |



- GB Ratchet screwdriver set  
D Ratschenschraubendreher-Satz mit einsetzen  
PL Zestaw wkrętak z grzechotką  
RUS Набор головок с трещоткой  
CZ Ráčnový kloubový šroubovák s příslušenstvím  
H Dugókulcs és bit készlet csukló  
RO Set surubelnita  
F Clé mixte à cliquet tête articulée + embouts  
I Set cacciavite a cricchetto  
E Juego con destornillador y carraca  
CN 棘轮螺丝批组套

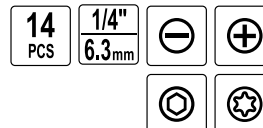

- 5, 6 mm;  
⊕ PH1, PH2;  
⊕ T15, T20;  
○ 5, 6, 7, 8, 10, 12, 13 mm

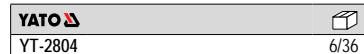

- GB 22 in 1 interchangeable screwdriver set  
D Umsteckschraubendreher  
PL Wkrętak z końcówkami dwustronnymi  
RUS Отвёртка - двухсторонние насадки  
CZ Šroubovák lancer s dvoustrannou koncovkou  
H Csavarhúzó kétvégű szárral

- RO Şurubelniţă cu dublu capăt  
F Tournevis + embouts 22 en 1  
I Set cacciavite con punte reversibile  
E Destornillador con punta dos caras  
CN 22合一螺丝批组套

DOUBLE BLISTER

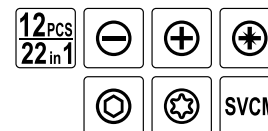

- 4 mm x 5.5 mm (L=175/115 mm);  
□ 6.5 mm x PH3 (L=175/115 mm);  
⊕ PH1 x PH2 (L=175/115 mm);  
⊕ PZ1 x PZ2 (L=175/115 mm);  
○ 3 mm x 3 mm (L=175/115 mm);  
○ 4 mm x 4 mm (L=175/115 mm);  
○ 5 mm x 5 mm (L=175/115 mm);  
○ 6 mm x 6 mm (L=175/115 mm);  
⊕ T10 x T15 (L=175/115 mm);  
⊕ T20 x T25 (L=175/115 mm);  
⊕ T30 x T40 (L=175/115 mm)



- GB Ratchet screwdriver set  
D Ratschenschraubendreher-set mit einsetzen  
PL Wkrętak z grzechotką, nasadkami i bitami  
RUS Набор головок с трещоткой  
CZ Ráčnový kloubový šroubovák s příslušenstvím  
H Dugókulcs és bit készlet csukló

- RO Set surubelnita  
F Clé mixte à cliquet + embouts + douilles  
I Set cacciavite a cricchetto con prese punta  
E Juego con destornillador y carraca  
CN 棘轮螺丝批组套

DOUBLE BLISTER

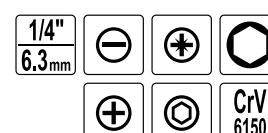

S2



- 1/4" (6.3 mm): 3.5, 4.0, 5.5, 6.5 mm (L=25 mm);  
⊕ 1/4" (6.3 mm): PH0, PH1, PH2, PH3 (L=25 mm);  
⊕ 1/4" (6.3 mm): PZ0, PZ1, PZ2, PZ3 (L=25 mm);  
○ 1/4" (6.3 mm): 4.0, 5.0, 6.0 mm (L=25 mm);  
□ 1/4" (6.3 mm): 5, 6(x2), 7(x2), 8, 9(x2), 10(x2), 11, 13 mm; CrV 6150;  
□ 1/4" (6.3 mm) x 1/4" (6.3 mm); (L=30 mm)

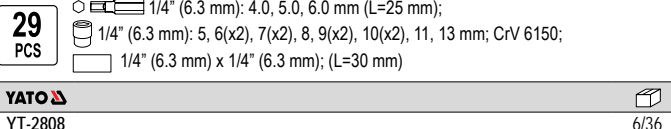

- 1/4" (6.3 mm): 3.5, 4.0, 5.5, 6.5 mm (L=25 mm);  
⊕ 1/4" (6.3 mm): PH0, PH1, PH2, PH3 (L=25 mm);  
⊕ 1/4" (6.3 mm): PZ0, PZ1, PZ2, PZ3 (L=25 mm);  
○ 1/4" (6.3 mm): 4.0, 5.0, 6.0 mm (L=25 mm);  
□ 1/4" (6.3 mm): 5, 6(x2), 7(x2), 8, 9(x2), 10(x2), 11, 13 mm; CrV 6150;  
□ 1/4" (6.3 mm) x 1/4" (6.3 mm); (L=30 mm); □ 1/4" (6.3 mm); (L=30 mm)

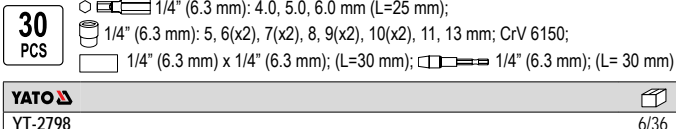



GB Ratchet screwdriver set  
 D Ratschenschraubendreher-Satz mit einsätzen  
 PL Wkrętak z grzechotką, przegubem i bitami  
 RUS Набор головок с трещеткой  
 CZ Ráčnový kloubový šroubovák s příslušenstvím

H Dugókulcs és bit készlet csukló  
 RO Set surubelnita  
 F Cliquet avec embouts  
 I Set di cacciavite a cricchetto e inserti  
 E Juego con destornillador y carraca  
 CN 棘轮螺丝批组套

BMC WITH WINDOW & COLOR BOX



1/4"  
6.3mm

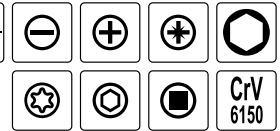

CrV 6150

S2

50 PCS METRIC & S.A.E.



- 1/4" (6.3 mm): 2.0, 3.0, 3.5, 4.0, 4.5, 5.5, 6.5 mm (L=25 mm); S2;
- ✦ 1/4" (6.3 mm): PH0, PH1, PH2, PH3 (L=25 mm); S2;
- ✦ 1/4" (6.3 mm): PZ0, PZ1, PZ2, PZ3 (L=25 mm); S2;
- ⊕ 1/4" (6.3 mm): T10, T15, T20, T25, T27, T30 (L=25 mm); S2;
- ⊙ 1/4" (6.3 mm): 2.0, 3.0, 4.0, 5.0, 6.0 mm (L=25 mm); S2;
- 1/4" (6.3 mm): SQ0, SQ1, SQ2, SQ3 (L=25 mm); S2;
- ⊖ 1/4" (6.3 mm): 5, 6, 7, 8, 9, 10, 11, 12, 13 mm; CrV 6150;
- ⊖ 1/4" (6.3 mm): 1/4" (6.3 mm) x 3/16" (4.8 mm), 1/4" (6.3 mm) x 7/32" (5.6 mm), 1/4" (6.3 mm) x 1/4" (6.3 mm), 1/4" (6.3 mm) x 5/16" (7.9 mm), 1/4" (6.3 mm) x 11/32" (8.7 mm), 1/4" (6.3 mm) x 3/8" (9.5 mm), 1/4" (6.3 mm) x 7/16" (11.1 mm), 1/4" (6.3 mm) x 15/32" (11.9 mm), 1/4" (6.3 mm) x 1/2" (12.7 mm); CrV 6150;
- ⊖ 1/4" (6.3 mm); (L=150 mm)

**YATO** YT-2799 6/24

75 PCS



- 1/4" (6.3 mm): 2.0(x2), 3.0(x2), 3.5(x2), 4.0(x2), 4.5(x2), 5.0(x2), 5.5(x2), 6.5(x2) mm (L=25 mm); S2;
- ✦ 1/4" (6.3 mm): PH0(x2), PH1(x2), PH2(x2), PH3(x2) (L=25 mm); S2;
- ✦ 1/4" (6.3 mm): PZ0(x3), PZ1(x3), PZ2(x2), PZ3(x2) (L=25 mm); S2;
- ⊕ 1/4" (6.3 mm): T10(x3), T15(x3), T20(x3), T25(x3), T27(x2), T30(x2) (L=25 mm); S2;
- ⊙ 1/4" (6.3 mm): 2.0, 3.0, 4.0, 5.0, 6.0 mm (L=25 mm); S2;
- 1/4" (6.3 mm): SQ0(x2), SQ1(x2), SQ2(x2), SQ3(x2) (L=25 mm); S2;
- ⊖ 1/4" (6.3 mm): 5, 6, 7, 8, 9, 10, 11, 12, 13 mm; CrV 6150;
- ⊖ 1/4" (6.3 mm); (L=60 mm); CrV 6150/S2

**YATO** YT-2571 6/24

GB Precision screwdriver with bits  
 D Schraubendreher und bit-satz  
 PL Wkrętak elastyczny z wymiennymi bitami  
 RUS Отвёртка с прецизионными битами  
 CZ Šroubovák ráčnový se sadou bitů  
 H Órás csavarահúzó-bit készlet  
 RO Surubelnita + set biti  
 F Tournevis élastique  
 I Cacciavite flessibile con punte intercambiabili  
 E Juego de piezas terminales para destornillador + mango  
 CN 可弯曲批头组套

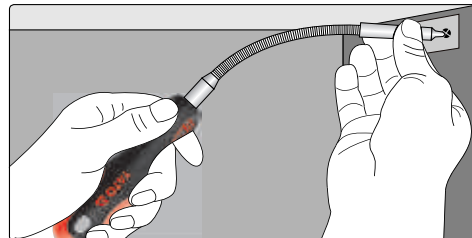

DOUBLE BLISTER



31 PCS 1/4" 6.3mm  
 S2 CrV 6150

- 215 mm;
- 1/4" (6.3 mm): 3.0, 3.5, 4.0, 5.5, 6.5 mm (L=25 mm);
- ✦ 1/4" (6.3 mm): PH0, PH1, PH2, PH3 (L=25 mm);
- ✦ 1/4" (6.3 mm): PZ0, PZ1, PZ2, PZ3 (L=25 mm);
- ⊕ 1/4" (6.3 mm): T10, T15 (L=25 mm);
- ⊙ 1/4" (6.3 mm): 2.0, 3.0, 4.0, 5.0, 6.0 mm (L=25 mm);
- ⊖ 1/4" (6.3 mm): 5.0, 6.0, 7.0, 8.0(x2), 9.0, 10.0, 11.0, 12.0, 13.0 mm



**YATO** YT-2780 6/24

- 215 mm;
- 1/4" (6.3 mm): 3.0, 3.5, 4.0, 5.5, 6.5 mm (L=25 mm);
- ✦ 1/4" (6.3 mm): PH0, PH1, PH2, PH3 (L=25 mm);
- ✦ 1/4" (6.3 mm): PZ0, PZ1, PZ2, PZ3 (L=25 mm);
- ⊕ 1/4" (6.3 mm): T10, T15 (L=25 mm);
- ⊙ 1/4" (6.3 mm): 2.0, 3.0, 4.0, 5.0, 6.0 mm (L=25 mm);
- ⊖ 1/4" (6.3 mm): 5.0, 6.0, 7.0, 8.0(x2), 9.0, 10.0, 11.0, 12.0, 13.0 mm



**YATO** YT-25972 6/24







GB Ratchet screwdriver set  
D Ratschenschraubendreher-Satz mit einsätzen  
PL Wkrętak z grzechotką, przegubem i bitami  
RUS Набор головок с трещеткой  
CZ Rácnový kloubový šroubovák s příslušenstvím









H Dugókulcs és bit készlet csukló  
RO Set surubelnita  
F Clé mixte à cliquet + embouts  
I Set do chiavi a cricchetto e inserti  
E Juego con destornillador y carraca  
CN 棘轮螺丝批组套

PLASTIC BOX  
& COLOR BOX



|                     |       |   |   |   |
|---------------------|-------|---|---|---|
| 42<br>PCS           | 1/4"  |  |  |  |
|                     | 6.3mm |  |  | CrV<br>50BV30   |
| BITS x30<br>AISI S2 |       |   |   |   |



 1/4" (6.3 mm): 5, 6, 7, 8, 9, 10, 11, 12, 13 mm;  1/4" (6.3 mm) x 100 mm;  
 1/4" (6.3 mm); CrV 50BV30;  H2, H2.5, H3, H4, H5, H6;  
 T10, T15, T20, T25, T27, T30, T40;  PH1, PH1, PH2, PH2, PH3, PH3;  
 3, 4, 5, 6, 7 mm;  PZ1, PZ1, PZ2, PZ2, PZ3, PZ3

|   |   |
|---|---|
| <b>YATO</b>  |  |
| YT-2806   | 12  |





GB Impact screwdriver  
D Schlagschrauber  
PL Wkrętak udarowy  
RUS Отвёртка ударная

CZ Narazový šroubovák kovový  
H Csavarbehajtó, ütő üzemmóddal  
RO Șurubelniță metalică cu percutor  
F Tournevis à choc





I Cacciavite percussione  
E Destornillador de percusión  
CN 冲击螺丝批组套

|                     |  |  |   |   |
|---------------------|--|--|---|---|
| BITS x6<br>CrV 6150 |   |   |  |  |
|                     |  |  | 1/2"  | 12.5mm  |
| 5/16"               |  |  |   |   |
| 8.0mm               |  |  |   |   |



8  
PCS 5/16" (7.9 mm)    1/2" (12.7 mm);  
 PH2, PH3 (L=35 mm); PH2 (L=80 mm);  
 8, 10 mm (L=35 mm); 8 mm (L=80 mm)







7  
PCS 5/16" (7.9 mm)   1/2" (12.7 mm);  
 PH2, PH3 (L=35 mm); PH2 (L=80 mm);  
 8, 10 mm (L=35 mm); 8 mm (L=80 mm)





|   |   |
|---|---|
| <b>YATO</b>  |  |
| YT-2800   | 20  |

|   |   |
|---|---|
| <b>YATO</b>  |  |
| YT-2801   | 5/20  |



7  
PCS 5/16" (7.9 mm)   1/2" (12.7 mm);  
 PH3 (L=35 mm); PH1, PH2, PH3 (L=75 mm);  
 8 mm (L=35 mm); 8 mm (L=75 mm)



|   |   |
|---|---|
| <b>YATO</b>  |  |
| YT-2802   | 20  |

GB Screwdriver bit set  
 D Schraubendreherbitsatz  
 PL Zestaw bitów do wkrętek uderowych  
 RUS Набор бит крестовых  
 CZ Sada bitů

H Bitkészlet  
 RO Truse bit  
 F Embouts à choc  
 I Set punte cacciavite  
 E Puntas de destornilladora  
 CN 冲击批头组套

CrV  
6150



for / dla: YT-2800, YT-2801

| YATO    | +   | -  | L (mm) | ⊕ (mm)         | PCS packing | 📦      |
|---------|-----|----|--------|----------------|-------------|--------|
| YT-2810 | PH2 |    | 36     | 5/16" (7.9 mm) | 5           | 10/100 |
| YT-2811 | PH3 |    | 36     | 5/16" (7.9 mm) | 5           | 10/100 |
| YT-2812 | PH2 | 8  | 36     | 5/16" (7.9 mm) | 4           | 10/100 |
|         | PH3 | 10 |        |                |             |        |

GB Screwdriver bit  
 D Schraubendreherbit  
 PL Końcówka śrubokrętowa  
 RUS Бит крестовая  
 CZ Šroubovaková koncovka  
 H Csavarhúzóvég

RO Capăt pt. șurubelniță  
 F Douille tournevis  
 I Punta del cacciavite  
 E Punta de destornilladora  
 CN 旋具头

BLISTER CARD



TORX

SAISI  
S2



| YATO     | ⊕   | L (mm) | ⊕ (mm) | 📦      |
|----------|-----|--------|--------|--------|
| YT-0404  | T25 | 30     | 10     | 10/100 |
| YT-0405  | T25 | 75     | 10     | 10/100 |
| YT-04051 | T30 | 30     | 10     | 10/100 |
| YT-04052 | T30 | 75     | 10     | 10/100 |
| YT-0406  | T40 | 30     | 10     | 10/100 |
| YT-0407  | T40 | 75     | 10     | 10/100 |
| YT-0408  | T45 | 30     | 10     | 10/100 |
| YT-0409  | T45 | 75     | 10     | 10/100 |

GB Screwdriver bit  
 D Schraubendreherbit  
 PL Końcówka śrubokrętowa  
 RUS Бит крестовая  
 CZ Šroubovaková koncovka  
 H Csavarhúzóvég

RO Capăt pt. șurubelniță  
 F Douille tournevis  
 I Punta del cacciavite  
 E Punta de destornilladora  
 CN 旋具头



+

GOLD FORGED KUTE NA ZIMNO

21.8 Nm max.

SAISI S2

HRC 58-62



SLIDING CARD



| YATO    | +   | L (mm) | ⊕ (mm)        | 📦      |
|---------|-----|--------|---------------|--------|
| YT-0485 | PH2 | 100    | 1/4" (6.3 mm) | 25/100 |
| YT-0486 | PH2 | 150    | 1/4" (6.3 mm) | 25/100 |
| YT-0487 | PH2 | 200    | 1/4" (6.3 mm) | 25/100 |

GB Screwdriver bit  
 D Schraubendreherbit  
 PL Końcówka śrubokrętowa  
 RUS Бит крестовая  
 CZ Šroubovaková koncovka  
 H Csavarhúzóvég

RO Capăt pt. șurubelniță  
 F Douille tournevis  
 I Punta del cacciavite  
 E Punta de destornilladora  
 CN 旋具头

PLASTIC BOX



SAISI S2

HRC 58-61

GOLD FORGED KUTE NA ZIMNO

+



NON-SLIP SYSTEM

+



NON-SLIP SYSTEM

| YATO     | +   | L (mm) | ⊕ (mm)        | torque / moment obrotowy max. (Nm) | PCS packing | 📦      |
|----------|-----|--------|---------------|------------------------------------|-------------|--------|
| YT-04702 | PZ1 | 25     | 1/4" (6.3 mm) | 6.4                                | 10          | 25/200 |
| YT-04712 | PZ2 | 25     | 1/4" (6.3 mm) | 19.6                               | 10          | 25/200 |
| YT-04722 | PZ3 | 25     | 1/4" (6.3 mm) | 45.1                               | 10          | 25/200 |

| YATO     | +   | L (mm) | ⊕ (mm)        | torque / moment obrotowy max. (Nm) | PCS packing | 📦      |
|----------|-----|--------|---------------|------------------------------------|-------------|--------|
| YT-04742 | PH1 | 25     | 1/4" (6.3 mm) | 6.4                                | 10          | 25/200 |
| YT-04752 | PH2 | 25     | 1/4" (6.3 mm) | 19.6                               | 10          | 25/200 |
| YT-04762 | PH3 | 25     | 1/4" (6.3 mm) | 45.1                               | 10          | 25/200 |

+



NON-SLIP SYSTEM

+



+

NON-SLIP SYSTEM

| YATO     | +   | L (mm) | ⊕ (mm)        | torque / moment obrotowy max. (Nm) | PCS packing | 📦      |
|----------|-----|--------|---------------|------------------------------------|-------------|--------|
| YT-04772 | PH1 | 50     | 1/4" (6.3 mm) | 6.4                                | 10          | 25/100 |
| YT-04782 | PH2 | 50     | 1/4" (6.3 mm) | 19.6                               | 10          | 25/100 |
| YT-04792 | PH3 | 50     | 1/4" (6.3 mm) | 45.1                               | 10          | 25/100 |

| YATO     | +   | +   | L (mm) | ⊕ (mm)        | torque / moment obrotowy max. (Nm) | PCS packing | 📦      |
|----------|-----|-----|--------|---------------|------------------------------------|-------------|--------|
| YT-04812 | PH2 | PH2 | 65     | 1/4" (6.3 mm) | 19.6 / 19.6                        | 10          | 25/100 |

GB Screwdriver bit set  
 D Schraubendreherbitsatz  
 PL Zestaw końcówek śrubokrętowych  
 RUS Набор битов  
 CZ Sada bitů  
 H Bitkészlet

RO Truse bit  
 F Embouts de vissage  
 I Set punte cacciavite  
 E Puntas de destornilladora  
 CN 旋具头组套

PLASTIC BOX



10 PCS

SAISI S2

HRC 58-61

GOLD FORGED KUTE NA ZIMNO



NON-SLIP SYSTEM



NON-SLIP SYSTEM

⊕ 5, 6 mm; ⊕ PH1, PH1, PH2, PH2;  
 ⊕ PZ1, PZ1, PZ2, PZ2

⊕ 5, 6 mm; ⊕ PH1, PH1, PH2, PH2;  
 ⊕ PZ1, PZ1, PZ2, PZ2

| YATO     | L (mm) | ⊕ (mm)        | 📦      |
|----------|--------|---------------|--------|
| YT-04822 | 25     | 1/4" (6.3 mm) | 25/200 |

| YATO     | L (mm) | ⊕ (mm)        | 📦      |
|----------|--------|---------------|--------|
| YT-04832 | 50     | 1/4" (6.3 mm) | 25/100 |



GB Screwdriver bit  
D Schraubendreherbit  
PL Końcówka śrubokrętowa  
RUS Бит крестовая

CZ Šroubovavá koncovka  
H Csavarhúzóvég  
RO Capăt pt. șurubelniță  
F Douille tournevis

I Punta del cacciavite  
E Punta de destornilladora  
CN 旋具头

PLASTIC BOX



AISI S2

HRC 58-61



| YATO     | +   | L (mm) | Hex           | torque / moment obrotowy max. (Nm) | PCS packing | Box    |
|----------|-----|--------|---------------|------------------------------------|-------------|--------|
| YT-78130 | PH0 | 25     | 1/4" (6.3 mm) | 2.1                                | 10          | 20/100 |
| YT-78131 | PH1 | 25     | 1/4" (6.3 mm) | 7.8                                | 10          | 20/100 |
| YT-78132 | PH2 | 25     | 1/4" (6.3 mm) | 19.6                               | 10          | 20/100 |
| YT-78133 | PH3 | 25     | 1/4" (6.3 mm) | 45.6                               | 10          | 20/100 |

| YATO     | +   | L (mm) | Hex           | torque / moment obrotowy max. (Nm) | PCS packing | Box    |
|----------|-----|--------|---------------|------------------------------------|-------------|--------|
| YT-78134 | PZ1 | 25     | 1/4" (6.3 mm) | 6.4                                | 10          | 20/100 |
| YT-78135 | PZ2 | 25     | 1/4" (6.3 mm) | 19.6                               | 10          | 20/100 |
| YT-78136 | PZ3 | 25     | 1/4" (6.3 mm) | 45.1                               | 10          | 20/100 |



| YATO     | +   | L (mm) | Hex           | torque / moment obrotowy max. (Nm) | PCS packing | Box    |
|----------|-----|--------|---------------|------------------------------------|-------------|--------|
| YT-78141 | T10 | 25     | 1/4" (6.3 mm) | 5.9                                | 10          | 20/100 |
| YT-78142 | T15 | 25     | 1/4" (6.3 mm) | 8.4                                | 10          | 20/100 |
| YT-78143 | T20 | 25     | 1/4" (6.3 mm) | 14.7                               | 10          | 20/100 |
| YT-78144 | T25 | 25     | 1/4" (6.3 mm) | 21.6                               | 10          | 20/100 |
| YT-78145 | T27 | 25     | 1/4" (6.3 mm) | 29.4                               | 10          | 20/100 |
| YT-78146 | T30 | 25     | 1/4" (6.3 mm) | 45.1                               | 10          | 20/100 |
| YT-78147 | T40 | 25     | 1/4" (6.3 mm) | 76.5                               | 10          | 20/100 |

| YATO     | +   | L (mm) | Hex           | torque / moment obrotowy max. (Nm) | PCS packing | Box    |
|----------|-----|--------|---------------|------------------------------------|-------------|--------|
| YT-78150 | PH0 | 50     | 1/4" (6.3 mm) | 2.1                                | 10          | 20/100 |
| YT-78151 | PH1 | 50     | 1/4" (6.3 mm) | 6.4                                | 10          | 20/100 |
| YT-78152 | PH2 | 50     | 1/4" (6.3 mm) | 19.6                               | 10          | 20/100 |
| YT-78153 | PH3 | 50     | 1/4" (6.3 mm) | 45.1                               | 10          | 20/100 |



| YATO     | +   | L (mm) | Hex           | torque / moment obrotowy max. (Nm) | PCS packing | Box    |
|----------|-----|--------|---------------|------------------------------------|-------------|--------|
| YT-78154 | PZ1 | 50     | 1/4" (6.3 mm) | 6.4                                | 10          | 20/100 |
| YT-78155 | PZ2 | 50     | 1/4" (6.3 mm) | 19.6                               | 10          | 20/100 |
| YT-78156 | PZ3 | 50     | 1/4" (6.3 mm) | 45.1                               | 10          | 20/100 |

| YATO     | +   | +   | L (mm) | Hex           | torque / moment obrotowy max. (Nm) | PCS packing | Box    |
|----------|-----|-----|--------|---------------|------------------------------------|-------------|--------|
| YT-78160 | PH1 | PH1 | 65     | 1/4" (6.3 mm) | 6.4 / 6.4                          | 10          | 20/100 |
| YT-78161 | PH2 | PH2 | 65     | 1/4" (6.3 mm) | 19.6 / 19.6                        | 10          | 20/100 |
| YT-78162 | PH3 | PH3 | 65     | 1/4" (6.3 mm) | 45.1 / 45.1                        | 10          | 20/100 |
| YT-78163 | PH1 | PH2 | 65     | 1/4" (6.3 mm) | 6.4 / 19.6                         | 10          | 20/100 |
| YT-78164 | PH2 | PH3 | 65     | 1/4" (6.3 mm) | 19.6 / 45.1                        | 10          | 20/100 |



| YATO     | +   | - | L (mm) | Hex           | torque / moment obrotowy max. (Nm) | PCS packing | Box    |
|----------|-----|---|--------|---------------|------------------------------------|-------------|--------|
| YT-78165 | PH1 |   | 4.5    | 1/4" (6.3 mm) | 6.4 / 6.1                          | 10          | 20/100 |
| YT-78166 | PH2 |   | 5.5    | 1/4" (6.3 mm) | 19.6 / 8.8                         | 10          | 20/100 |
| YT-78167 | PH3 |   | 6.5    | 1/4" (6.3 mm) | 45.1 / 14.7                        | 10          | 20/100 |

| YATO     | +   | L (mm) | Hex (mm) | torque / moment obrotowy max. (Nm) | PCS packing | Box    |
|----------|-----|--------|----------|------------------------------------|-------------|--------|
| YT-78190 | M5  | 30     | 8        | 20.6                               | 10          | 20/100 |
| YT-78191 | M6  | 30     | 8        | 40.2                               | 10          | 20/100 |
| YT-78192 | M8  | 30     | 8        | 60.8                               | 10          | 20/100 |
| YT-78193 | M10 | 30     | 8        | 156.9                              | 8           | 10/50  |
| YT-78194 | M12 | 30     | 8        | 176.5                              | 6           | 10/50  |

GB Screwdriver bit set  
D Schraubendreherbitsatz  
PL Zestaw końcówek śrubokrętowych  
RUS Набор битов  
CZ Sada bitů  
H Bitkészlet

RO Truse bit  
F Embouts de vissage  
I Set punte cacciavite  
E Puntas de destornilladora  
CN 旋具头组套



SLIDING CARD



COLD FORGED KUTE NA ZIMNO

218Nm max.

AISI S2

HRC 58-62



10 PCS



10 PCS



10 PCS



| YATO    | +   | L (mm) | Hex           | Box    |
|---------|-----|--------|---------------|--------|
| YT-0470 | PZ1 | 25     | 1/4" (6.3 mm) | 25/200 |
| YT-0471 | PZ2 | 25     | 1/4" (6.3 mm) | 25/200 |
| YT-0472 | PZ3 | 25     | 1/4" (6.3 mm) | 25/200 |

| YATO    | +   | L (mm) | Hex           | Box    |
|---------|-----|--------|---------------|--------|
| YT-0477 | PH1 | 50     | 1/4" (6.3 mm) | 25/100 |
| YT-0478 | PH2 | 50     | 1/4" (6.3 mm) | 25/100 |
| YT-0479 | PH3 | 50     | 1/4" (6.3 mm) | 25/100 |
| YT-0480 | PH2 | 75     | 1/4" (6.3 mm) | 25/100 |

| YATO    | +   | L (mm) | Hex           | Box    |
|---------|-----|--------|---------------|--------|
| YT-0473 | PH0 | 25     | 1/4" (6.3 mm) | 25/200 |
| YT-0474 | PH1 | 25     | 1/4" (6.3 mm) | 25/200 |
| YT-0475 | PH2 | 25     | 1/4" (6.3 mm) | 25/200 |
| YT-0476 | PH3 | 25     | 1/4" (6.3 mm) | 25/200 |



10 PCS



10 PCS



10 PCS



| YATO    | +   | L (mm) | Hex           | Box    |
|---------|-----|--------|---------------|--------|
| YT-0481 | PH2 | 65     | 1/4" (6.3 mm) | 25/100 |

| YATO    | + | L (mm) | Hex           | Box    |
|---------|---|--------|---------------|--------|
| YT-0482 |   | 25     | 1/4" (6.3 mm) | 25/200 |

| YATO    | + | L (mm) | Hex           | Box    |
|---------|---|--------|---------------|--------|
| YT-0483 |   | 50     | 1/4" (6.3 mm) | 25/100 |

□ 5, 6 mm; ⊕ PH1, PH1, PH2, PH2;  
⊕ PZ1, PZ1, PZ2, PZ2

□ 5, 6 mm; ⊕ PH1, PH1, PH2, PH2;  
⊕ PZ1, PZ1, PZ2, PZ2

GB Screwdriver bit  
D Schraubendreherbit  
PL Końcówka śrubokrętowa

RUS Бит крестовая  
CZ Šroubovaková koncovka  
H Csavarhúzóvég

RO Capăt pt. șurubelniță  
F Douille tournevis  
I Punta del cacciavite

E Punta de destornilladora  
CN 旋具头

COLOR BOX



AISI S2

HRC 58-62

GOLD FORGED KUTE NA ZIMNO



| YATO    | ⊖   | L (mm) | ⊖             | PCS packing | 📦     |
|---------|-----|--------|---------------|-------------|-------|
| YT-7800 | 3.0 | 25     | 1/4" (6.3 mm) | 50          | 20/40 |
| YT-7801 | 4.0 | 25     | 1/4" (6.3 mm) | 50          | 20/40 |
| YT-7802 | 5.0 | 25     | 1/4" (6.3 mm) | 50          | 20/40 |
| YT-7803 | 5.5 | 25     | 1/4" (6.3 mm) | 50          | 20/40 |
| YT-7804 | 6.0 | 25     | 1/4" (6.3 mm) | 50          | 20/40 |
| YT-7805 | 6.5 | 25     | 1/4" (6.3 mm) | 50          | 20/40 |



| YATO    | ⊕   | L (mm) | ⊕             | PCS packing | 📦     |
|---------|-----|--------|---------------|-------------|-------|
| YT-7806 | PH0 | 25     | 1/4" (6.3 mm) | 50          | 20/40 |
| YT-7807 | PH1 | 25     | 1/4" (6.3 mm) | 50          | 20/40 |
| YT-7808 | PH2 | 25     | 1/4" (6.3 mm) | 50          | 20/40 |
| YT-7809 | PH3 | 25     | 1/4" (6.3 mm) | 50          | 20/40 |



| YATO    | ⊕   | L (mm) | ⊕             | PCS packing | 📦     |
|---------|-----|--------|---------------|-------------|-------|
| YT-7810 | PZ1 | 25     | 1/4" (6.3 mm) | 50          | 20/40 |
| YT-7811 | PZ2 | 25     | 1/4" (6.3 mm) | 50          | 20/40 |
| YT-7812 | PZ3 | 25     | 1/4" (6.3 mm) | 50          | 20/40 |



5



| YATO    | ⊕   | L (mm) | ⊕             | PCS packing | 📦     |
|---------|-----|--------|---------------|-------------|-------|
| YT-7813 | T8  | 25     | 1/4" (6.3 mm) | 50          | 20/40 |
| YT-7814 | T10 | 25     | 1/4" (6.3 mm) | 50          | 20/40 |
| YT-7815 | T15 | 25     | 1/4" (6.3 mm) | 50          | 20/40 |
| YT-7816 | T20 | 25     | 1/4" (6.3 mm) | 50          | 20/40 |
| YT-7817 | T25 | 25     | 1/4" (6.3 mm) | 50          | 20/40 |
| YT-7818 | T27 | 25     | 1/4" (6.3 mm) | 50          | 20/40 |



| YATO    | ⊕   | L (mm) | ⊕             | PCS packing | 📦     |
|---------|-----|--------|---------------|-------------|-------|
| YT-7826 | T27 | 25     | 1/4" (6.3 mm) | 50          | 20/40 |



| YATO    | ⊕   | L (mm) | ⊕             | PCS packing | 📦     |
|---------|-----|--------|---------------|-------------|-------|
| YT-7829 | 2.0 | 25     | 1/4" (6.3 mm) | 50          | 20/40 |
| YT-7834 | 6.0 | 25     | 1/4" (6.3 mm) | 50          | 20/40 |



| YATO    | ⊕   | L (mm) | ⊕             | PCS packing | 📦     |
|---------|-----|--------|---------------|-------------|-------|
| YT-7846 | PH0 | 50     | 1/4" (6.3 mm) | 50          | 10/20 |
| YT-7847 | PH1 | 50     | 1/4" (6.3 mm) | 50          | 10/20 |
| YT-7848 | PH2 | 50     | 1/4" (6.3 mm) | 50          | 10/20 |
| YT-7849 | PH3 | 50     | 1/4" (6.3 mm) | 50          | 10/20 |



| YATO    | ⊕   | L (mm) | ⊕             | PCS packing | 📦     |
|---------|-----|--------|---------------|-------------|-------|
| YT-7851 | PZ2 | 50     | 1/4" (6.3 mm) | 50          | 10/20 |
| YT-7852 | PZ3 | 50     | 1/4" (6.3 mm) | 50          | 10/20 |



| YATO    | ⊕   | L (mm) | ⊕             | PCS packing | 📦     |
|---------|-----|--------|---------------|-------------|-------|
| YT-7870 | 2.5 | 50     | 1/4" (6.3 mm) | 50          | 10/20 |



| YATO    | ⊕   | ⊕   | L (mm) | ⊕             | PCS packing | 📦     |
|---------|-----|-----|--------|---------------|-------------|-------|
| YT-7880 | PH1 | PH1 | 65     | 1/4" (6.3 mm) | 50          | 10/20 |
| YT-7881 | PH2 | PH2 | 65     | 1/4" (6.3 mm) | 50          | 10/20 |
| YT-7882 | PH3 | PH3 | 65     | 1/4" (6.3 mm) | 50          | 10/20 |
| YT-7883 | PH1 | PH2 | 65     | 1/4" (6.3 mm) | 50          | 10/20 |
| YT-7884 | PH2 | PH3 | 65     | 1/4" (6.3 mm) | 50          | 10/20 |

| YATO    | ⊕   | ⊖   | L (mm) | ⊕             | PCS packing | 📦     |
|---------|-----|-----|--------|---------------|-------------|-------|
| YT-7886 | PH2 | 5.5 | 65     | 1/4" (6.3 mm) | 50          | 10/20 |
| YT-7887 | PH3 | 6.5 | 65     | 1/4" (6.3 mm) | 50          | 10/20 |

| YATO    | ⊕   | ⊕   | L (mm) | ⊕             | PCS packing | 📦     |
|---------|-----|-----|--------|---------------|-------------|-------|
| YT-7890 | PH3 | PH3 | 110    | 1/4" (6.3 mm) | 20          | 10/20 |

GB Screwdriver bit  
D Schraubendreherbit  
PL Końcówka śrubokrętowa

RUS Бит крестовая  
CZ Šroubovaková koncovka  
H Csavarhúzóvég

RO Capăt pt. șurubelniță  
F Douille tournevis  
I Punta del cacciavite

E Punta de destornilladora  
CN 旋具头

COLOR BOX



AISI S2

HRC 58-62



| YATO    | ⊕   | L (mm) | ⊕ (mm) | PCS packing | 📦     |
|---------|-----|--------|--------|-------------|-------|
| YT-7897 | T10 | 30     | 8      | 50          | 10/20 |
| YT-7898 | T15 | 30     | 8      | 50          | 10/20 |
| YT-7899 | T20 | 30     | 8      | 50          | 10/20 |
| YT-7901 | T27 | 30     | 8      | 50          | 10/20 |
| YT-7906 | T55 | 30     | 8      | 20          | 10/40 |



| YATO    | ⊕   | L (mm) | ⊕ (mm) | PCS packing | 📦     |
|---------|-----|--------|--------|-------------|-------|
| YT-7909 | T15 | 30     | 8      | 50          | 10/20 |
| YT-7910 | T20 | 30     | 8      | 50          | 10/20 |
| YT-7911 | T25 | 30     | 8      | 50          | 10/20 |
| YT-7912 | T27 | 30     | 8      | 50          | 10/20 |
| YT-7916 | T50 | 30     | 8      | 50          | 10/20 |



| YATO    | ⊕   | L (mm) | ⊕ (mm) | PCS packing | 📦     |
|---------|-----|--------|--------|-------------|-------|
| YT-7929 | M5  | 30     | 8      | 50          | 10/20 |
| YT-7930 | M6  | 30     | 8      | 50          | 10/20 |
| YT-7931 | M8  | 30     | 8      | 50          | 10/20 |
| YT-7932 | M10 | 30     | 8      | 20          | 10/40 |
| YT-7933 | M12 | 30     | 8      | 20          | 10/20 |



| YATO    | ⊖   | L (mm) | ⊖ (mm) | PCS packing | 📦     |
|---------|-----|--------|--------|-------------|-------|
| YT-7936 | 8.0 | 70     | 8      | 20          | 10/20 |



| YATO    | ⊕   | L (mm) | ⊕ | PCS packing | 📦    |
|---------|-----|--------|---|-------------|------|
| YT-7950 | T60 | 70     | 8 | 20          | 5/10 |

GB Screwdriver bit  
D Schraubendreherbit  
PL Końcówka śrubokrętowa  
RUS Бит крестовая  
CZ Šroubovaková koncovka  
H Csavarhúzóvég

RO Capăt pt. șurubelniță  
F Douille tournevis  
I Punta del cacciavite  
E Punta de destornilladora  
CN 旋具头



• with limiter  
• z ogranicznikiem

COLOR BOX



| YATO    | L (mm) | ⊕             | PCS packing | 📦     |
|---------|--------|---------------|-------------|-------|
| YT-7980 | 25     | 1/4" (6.3 mm) | 20          | 20/40 |



GB Screwdriver bit  
D Schraubendreherbit  
PL Końcówka śrubokrętowa  
RUS Бит крестовая

CZ Šroubovaková koncovka  
H Csavarhúzóvég  
RO Capăt pt. șurubelniță  
F Douille tournevis

I Punta del cacciavite  
E Punta de destornilladora  
CN 旋具头

SLIDING CARD



2  
PCS

1/4"  
(6.3mm)

S2

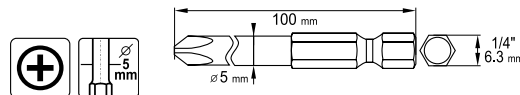
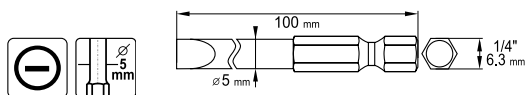

| YATO    | ⊖   | L (mm) | ⊘             | 📦      |
|---------|-----|--------|---------------|--------|
| YT-0484 | 4.0 | 100    | 1/4" (6.3 mm) | 25/100 |
|         | 5.0 | 100    |               |        |

| YATO    | ⊕    | L (mm) | ⊘             | 📦      |
|---------|------|--------|---------------|--------|
| YT-0459 | PH00 | 100    | 1/4" (6.3 mm) | 25/100 |
|         | PH0  | 100    |               |        |

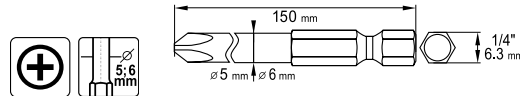
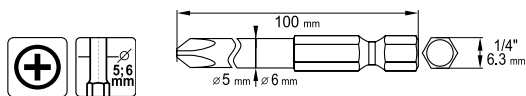

| YATO    | ⊕   | L (mm) | ⊘             | 📦      |
|---------|-----|--------|---------------|--------|
| YT-0488 | PH1 | 100    | 1/4" (6.3 mm) | 25/100 |
|         | PH2 | 100    |               |        |

| YATO    | ⊕   | L (mm) | ⊘             | 📦      |
|---------|-----|--------|---------------|--------|
| YT-0489 | PH1 | 150    | 1/4" (6.3 mm) | 25/100 |
|         | PH2 | 150    |               |        |

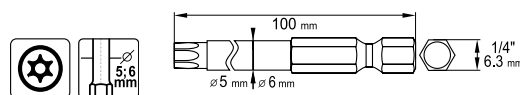
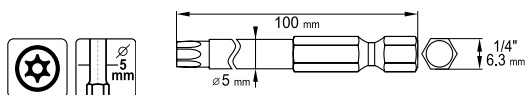

| YATO    | ⊗   | L (mm) | ⊘             | 📦      |
|---------|-----|--------|---------------|--------|
| YT-0490 | T10 | 100    | 1/4" (6.3 mm) | 25/100 |
|         | T25 | 100    |               |        |

| YATO    | ⊗   | L (mm) | ⊘             | 📦      |
|---------|-----|--------|---------------|--------|
| YT-0491 | T15 | 100    | 1/4" (6.3 mm) | 25/100 |
|         | T27 | 100    |               |        |

| YATO    | ⊗   | L (mm) | ⊘             | 📦      |
|---------|-----|--------|---------------|--------|
| YT-0492 | T20 | 100    | 1/4" (6.3 mm) | 25/100 |
|         | T30 | 100    |               |        |

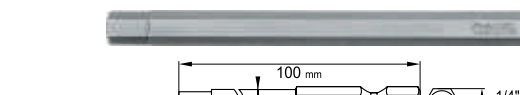
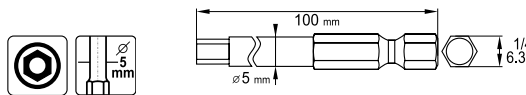
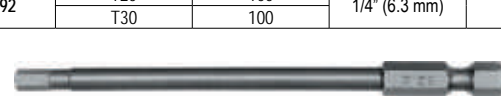

| YATO    | ⊙   | L (mm) | ⊘             | 📦      |
|---------|-----|--------|---------------|--------|
| YT-0494 | 3.0 | 100    | 1/4" (6.3 mm) | 25/100 |
|         | 5.0 | 100    |               |        |

| YATO    | ⊙   | L (mm) | ⊘             | 📦      |
|---------|-----|--------|---------------|--------|
| YT-0495 | 4.0 | 100    | 1/4" (6.3 mm) | 25/100 |
|         | 6.0 | 100    |               |        |

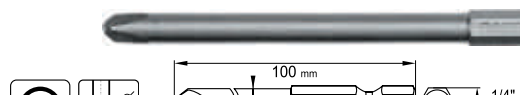
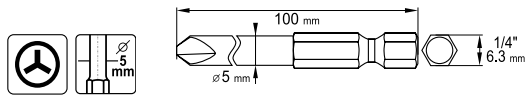
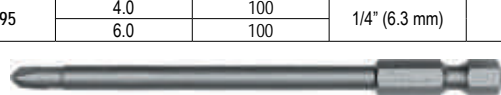

| YATO    | ⊕  | L (mm) | ⊘             | 📦      |
|---------|----|--------|---------------|--------|
| YT-0493 | #0 | 100    | 1/4" (6.3 mm) | 25/100 |
|         | #1 | 100    |               |        |

| YATO    | ⊕  | L (mm) | ⊘             | 📦      |
|---------|----|--------|---------------|--------|
| YT-0497 | #2 | 100    | 1/4" (6.3 mm) | 25/100 |
|         | #4 | 100    |               |        |

| YATO    | ⊕  | L (mm) | ⊘             | 📦      |
|---------|----|--------|---------------|--------|
| YT-0496 | #1 | 100    | 1/4" (6.3 mm) | 25/100 |
|         | #3 | 100    |               |        |

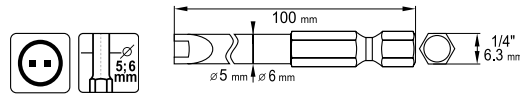
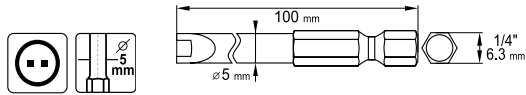

| YATO    | ⊕  | L (mm) | ⊘             | 📦      |
|---------|----|--------|---------------|--------|
| YT-0498 | #4 | 100    | 1/4" (6.3 mm) | 25/100 |
|         | #8 | 100    |               |        |

| YATO    | ⊕   | L (mm) | ⊘             | 📦      |
|---------|-----|--------|---------------|--------|
| YT-0499 | #6  | 100    | 1/4" (6.3 mm) | 25/100 |
|         | #10 | 100    |               |        |

- GB Screwdriver bit set
- D Schraubendreherbitsatz
- PL Zestaw końcówek śrubokrętowych
- RUS Набор битов
- CZ Sada bitů
- H Bitkészlet
- RO Truse bit
- F Embouts de vissage
- I Set punte cacciavite
- E Puntas de destornilladora
- CN 旋具头组套



218 Nm max. AISI S2 HRC 58-62

40 PCS HEX SPLINE TORX

○ x14: L=30 mm: H4, H5, H6, H7, H8, H10, H12;  
 L=75 mm: H4, H5, H6, H7, H8, H10, H12; AISI S2;  
 ○ x10: L=30 mm: M5, M6, M8, M10, M12;  
 L=75 mm: M5, M6, M8, M10, M12; AISI S2;  
 ⊕ x14: L=30 mm: T20, T25, T30, T40, T45, T50, T55;  
 L=75 mm: T20, T25, T30, T40, T45, T50, T55; AISI S2;  
 ⊕ x2: 1/2" (12.7 mm): 10 mm, 3/8" (9.5 mm): 10 mm; CrV 6150

METAL CASE & COLOR BOX

**YATO** YT-0400 10

7 PCS TORX



⊕ x6: L=30 mm: T25, T30, T40, T45, T50, T55; AISI S2;  
 1/2" (12.7 mm): 10 mm; CrV 6150

HANGING COLOR BOX

**YATO** YT-0410 24/72

7 PCS HEX



○ x6: L=30 mm: H4, H5, H6, H8, H10, H12 mm; AISI S2;  
 1/2" (12.7 mm): 10 mm; CrV 6150

HANGING COLOR BOX

**YATO** YT-0412 24/72

6 PCS SPLINE



○ x5: L=30 mm: M5, M6, M8, M10, M12; AISI S2;  
 1/2" (12.7 mm): 10 mm; CrV 6150

HANGING COLOR BOX

**YATO** YT-0414 24/72

7 PCS TORX TAMPERPROOF



⊕ x6: L=30 mm: T25, T30, T40, T45, T50, T55; AISI S2;  
 1/2" (12.7 mm): 10 mm; CrV 6150

HANGING COLOR BOX

**YATO** YT-0416 24/72

8 PCS RIBE



⊕ x7: L=30 mm: M5, M6, M7, M8, M10, M12, M14; AISI S2;  
 1/2" (12.7 mm): 10 mm; CrV 6150

HANGING COLOR BOX

**YATO** YT-0418 24/72

42 PCS RIBE TORX TAMPERPROOF



⊕ x18: L=30 mm: T20, T25, T30, T40, T45, T50, T55, T60, T70; AISI S2; L=75 mm: T20, T25, T30, T40, T45, T50, T55, T60, T70; AISI S2;  
 ⊕ x22: L=30 mm: M4, M5, M6, M7, M8, M9, M10, M11, M12, M13, M14; AISI S2; L=75 mm: M4, M5, M6, M7, M8, M9, M10, M11, M12, M13, M14; AISI S2;  
 ⊕ x2: 1/2" (12.7 mm): 10 mm, 3/8" (9.5 mm): 10 mm; CrV 6150

METAL CASE & COLOR BOX

**YATO** YT-0420 10



- GB Nut setter  
D Magnet-Steckschlüssel mit Adapter  
PL Nasadka magnetyczna do wkrętarki  
RUS Магнитная головка для винтовёрта  
CZ Nástrčný klíč magnetický do vrtačky  
H Csavarbehajtó  
RO Cheie tubulara cu prindere tip mandrina  
F Douille tournevis magnétique  
I Cappuccio magnetico la vite  
E Boquilla magnética de destornilladora  
CN 磁性套筒



| YATO    | Hex | PCS packing | Box     |
|---------|-----|-------------|---------|
| YT-1501 | 6   | 20          | 200/600 |
| YT-1502 | 7   | 20          | 200/600 |
| YT-1503 | 8   | 20          | 200/600 |
| YT-1505 | 10  | 20          | 200/600 |
| YT-1507 | 12  | 20          | 200/600 |
| YT-1508 | 13  | 20          | 200/600 |

| YATO    | Hex | Box     |
|---------|-----|---------|
| YT-1511 | 6   | 100/200 |
| YT-1512 | 7   | 100/200 |
| YT-1513 | 8   | 100/200 |
| YT-1515 | 10  | 100/200 |
| YT-1517 | 12  | 100/200 |
| YT-1518 | 13  | 100/200 |

- GB Screwdriver bit holder  
D Bithalter  
PL Uchwyt do końcówek śrubokrętowych  
RUS Магнитный держатель  
CZ Držák na šroubovavkovékoncovky  
H Szár a csavarhúzóvégkehez  
RO Capete şurubelniţă  
F Mandrin magnétique  
I Mandrino portapunta  
E Mandril para puntas  
CN 旋具磁性接杆

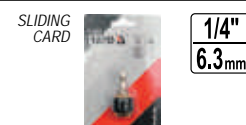

1/4"  
6.3mm



| YATO    | Hex           | L (mm) | Box    |
|---------|---------------|--------|--------|
| YT-0465 | 1/4" (6.3 mm) | 60     | 20/200 |

| YATO    | Hex           | L (mm) | Box    |
|---------|---------------|--------|--------|
| YT-0466 | 1/4" (6.3 mm) | 60     | 20/200 |



| YATO    | Hex           | L (mm) | Box    |
|---------|---------------|--------|--------|
| YT-0467 | 1/4" (6.3 mm) | 80     | 20/200 |

| YATO    | Hex           | L (mm) | Box    |
|---------|---------------|--------|--------|
| YT-0468 | 1/4" (6.3 mm) | 60     | 20/200 |

- GB Hex with ball with handle  
D Aufsteckschlüssel  
PL Klucz trzpieniowy z rączką  
RUS Ключ торцевой  
CZ Čepový klíč  
H Csapkulcs  
RO Chei cu cozi  
F Tournevis 6 pans à boule  
I Cacciavite a brugola con testina a sfera  
E Llave de mandril  
CN 球头内六角螺丝批

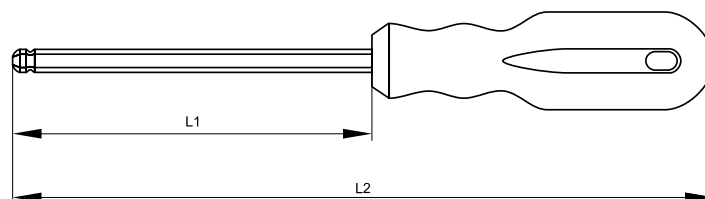

COLOR BOX



| YATO    | Ø (mm) | L1 (mm) | L2 (mm) | PCS packing | Box |
|---------|--------|---------|---------|-------------|-----|
| YT-1530 | 2.0    | 75      | 175     | 12          | 240 |
| YT-1531 | 2.5    | 75      | 175     | 12          | 240 |
| YT-1532 | 3.0    | 100     | 200     | 12          | 240 |
| YT-1533 | 4.0    | 100     | 205     | 12          | 240 |

| YATO    | Ø (mm) | L1 (mm) | L2 (mm) | PCS packing | Box |
|---------|--------|---------|---------|-------------|-----|
| YT-1534 | 5.0    | 100     | 205     | 12          | 240 |
| YT-1535 | 6.0    | 125     | 242     | 12          | 240 |
| YT-1537 | 8.0    | 150     | 278     | 6           | 120 |
| YT-1539 | 10.0   | 150     | 278     | 6           | 120 |

- GB Hex key
- D Sechskant-Stiftschlüssel
- PL Klucz sześciokątny
- RUS Шестигранный
- CZ Imbusový klíč
- H Imbisz kulcs
- RO Cheie imbus
- F Clé Allen
- I Chiave a brugola
- E Llave hexagonal
- CN 内六角扳手

HEX CrV 6150 HRC 52-55

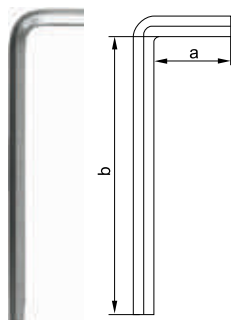

| YATO    | Ø (mm) | a (mm) | b (mm) | PCS    |
|---------|--------|--------|--------|--------|
| YT-0546 | 6      | 24     | 110    | 20/200 |

5

- GB Hex key
- RUS Шестигранный
- RO Cheie imbus
- E Llave hexagonal
- D Sechskant-Stiftschlüssel
- CZ Imbusový klíč
- F Clé Allen
- CN 内六角扳手
- PL Klucz sześciokątny
- H Imbisz kulcs
- I Chiave esagonale

POUCH



CrV 6150

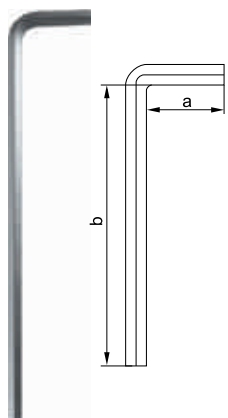

EXTRA LONG HEX

| YATO    | Ø (mm) | a (mm) | b (mm) | PCS packing: |
|---------|--------|--------|--------|--------------|
| YT-5761 | 2.0    | 16     | 99     | 12 20/80     |

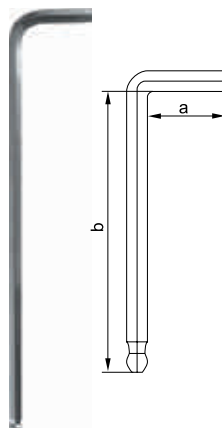

EXTRA LONG HEX WITH BALL

S.A.E.

25°

| YATO    | Ø (mm)         | a (mm) | b (mm) | PCS packing: |
|---------|----------------|--------|--------|--------------|
| YT-5770 | 1/16" (1.6 mm) | 14     | 90     | 12 20/80     |
| YT-5771 | 5/64" (2.0 mm) | 16     | 100    | 12 20/80     |
| YT-5772 | 3/32" (2.4 mm) | 17     | 111    | 12 20/80     |
| YT-5773 | 7/64" (2.8 mm) | 18     | 116    | 12 20/80     |
| YT-5774 | 1/8" (3.2 mm)  | 19     | 123    | 12 20/80     |
| YT-5775 | 9/64" (3.6 mm) | 20     | 130    | 12 20/80     |
| YT-5777 | 3/16" (4.8 mm) | 24     | 151    | 6 10/20      |
| YT-5778 | 7/32" (5.6 mm) | 25     | 165    | 6 10/20      |
| YT-5779 | 1/4" (6.3 mm)  | 28     | 183    | 6 10/20      |
| YT-5780 | 5/16" (7.9 mm) | 32     | 202    | 6 10/20      |
| YT-5781 | 3/8" (9.5 mm)  | 35     | 233    | 6 10/20      |

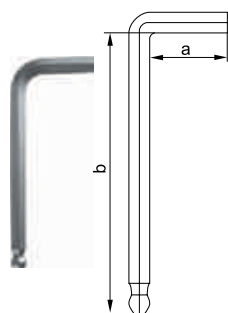

STANDARD HEX WITH BALL

25°

| YATO    | Ø (mm) | a (mm) | b (mm) | PCS packing: |
|---------|--------|--------|--------|--------------|
| YT-5785 | 1.5    | 13     | 45     | 12 20/80     |
| YT-5786 | 2.0    | 15     | 49     | 12 20/80     |
| YT-5791 | 6.0    | 30     | 91     | 6 20/40      |
| YT-5792 | 7.0    | 32     | 95     | 6 20/40      |
| YT-5793 | 8.0    | 34     | 98     | 6 20/40      |
| YT-5794 | 10.0   | 37     | 111    | 6 20/40      |

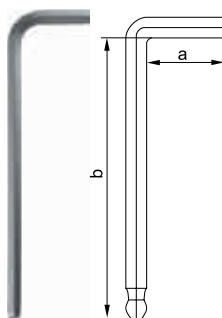

LONG HEX WITH BALL

25°

| YATO    | Ø (mm) | a (mm) | b (mm) | PCS packing: |
|---------|--------|--------|--------|--------------|
| YT-5795 | 1.5    | 13     | 62     | 12 20/80     |
| YT-5796 | 2.0    | 15     | 75     | 12 20/80     |
| YT-5797 | 2.5    | 17     | 85     | 12 20/80     |
| YT-5798 | 3.0    | 19     | 89     | 12 20/80     |
| YT-5802 | 7.0    | 33     | 140    | 6 20/40      |
| YT-5803 | 8.0    | 34     | 150    | 6 20/40      |
| YT-5804 | 10.0   | 36     | 172    | 6 20/40      |

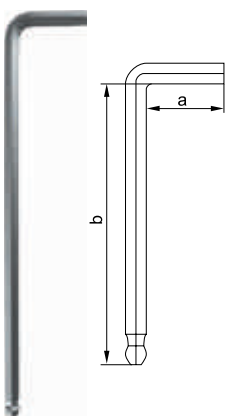

EXTRA LONG HEX WITH BALL

25°

| YATO    | Ø (mm) | a (mm) | b (mm) | PCS packing: |
|---------|--------|--------|--------|--------------|
| YT-5805 | 1.5    | 14     | 89     | 12 20/80     |
| YT-5806 | 2.0    | 15     | 99     | 12 20/80     |
| YT-5807 | 2.5    | 18     | 110    | 12 20/80     |
| YT-5808 | 3.0    | 20     | 124    | 12 20/80     |
| YT-5812 | 7.0    | 31     | 187    | 6 10/20      |
| YT-5813 | 8.0    | 34     | 198    | 6 10/20      |
| YT-5814 | 10.0   | 38     | 220    | 6 10/20      |



- GB TORX key
- D TORX-Stiftschlüssel
- PL Klucz TORX
- RUS Ключ TORX
- CZ Klíč TORX
- H Kulcs TORX
- RO Cheie TORX
- F Clé TORX
- I Chiavi TORX
- E Llave TORX
- CN 内六角扳手

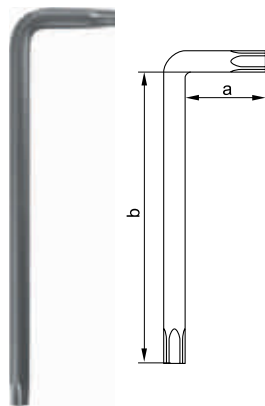

POUCH



CrV  
6150

| YATO    | ⊖   | a (mm) | b (mm) | PCS packing |       |
|---------|-----|--------|--------|-------------|-------|
| YT-5820 | T6  | 16     | 69     | 12          | 20/80 |
| YT-5821 | T7  | 16     | 73     | 12          | 20/80 |
| YT-5822 | T8  | 16     | 77     | 12          | 20/80 |
| YT-5823 | T9  | 16     | 81     | 12          | 20/80 |
| YT-5832 | T50 | 32     | 155    | 6           | 20/40 |
| YT-5833 | T55 | 35     | 164    | 6           | 20/40 |

- GB Hex key set
- D Sechskant-Stiftschlüsselsatz
- PL Zestaw kluczy imbusowych
- RUS Набор шестигранников

- CZ Imbusové klíče
- H Imbisz kulcs
- RO Chei imbus
- F Set de clés Allen

- I Set di chiavi a brugola
- E Juego de llaves hex
- CN 内六角扳手组套

PLASTIC HANGER & SLIDING CARD



12  
PCS

CrV  
6150

S.A.E.

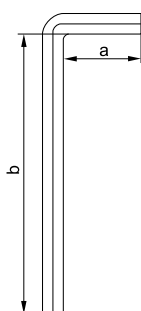

| YATO          | ⊖              | a (mm) | b (mm) |      |
|---------------|----------------|--------|--------|------|
| YT-5835       | 1/16" (1.6 mm) | 14     | 74     | 6/36 |
|               | 5/64" (2.0 mm) | 16     | 79     |      |
|               | 3/32" (2.4 mm) | 17     | 83     |      |
|               | 7/64" (2.8 mm) | 18     | 88     |      |
|               | 1/8" (3.2 mm)  | 19     | 93     |      |
|               | 9/64" (3.6 mm) | 20     | 99     |      |
|               | 5/32" (4.0 mm) | 21     | 105    |      |
|               | 3/16" (4.8 mm) | 24     | 113    |      |
|               | 7/32" (5.6 mm) | 25     | 122    |      |
|               | 1/4" (6.3 mm)  | 28     | 132    |      |
|               | 5/16" (7.9 mm) | 32     | 150    |      |
| 3/8" (9.5 mm) | 35             | 170    |        |      |

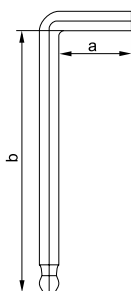

| YATO          | ⊖              | a (mm) | b (mm) |      |
|---------------|----------------|--------|--------|------|
| YT-5837       | 1/16" (1.6 mm) | 14     | 74     | 6/36 |
|               | 5/64" (2.0 mm) | 16     | 79     |      |
|               | 3/32" (2.4 mm) | 17     | 83     |      |
|               | 7/64" (2.8 mm) | 18     | 88     |      |
|               | 1/8" (3.2 mm)  | 19     | 93     |      |
|               | 9/64" (3.6 mm) | 20     | 99     |      |
|               | 5/32" (4.0 mm) | 21     | 105    |      |
|               | 3/16" (4.8 mm) | 24     | 113    |      |
|               | 7/32" (5.6 mm) | 25     | 122    |      |
|               | 1/4" (6.3 mm)  | 28     | 132    |      |
|               | 5/16" (7.9 mm) | 32     | 150    |      |
| 3/8" (9.5 mm) | 35             | 170    |        |      |

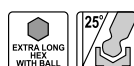

| YATO          | ⊖              | a (mm) | b (mm) |      |
|---------------|----------------|--------|--------|------|
| YT-5838       | 1/16" (1.6 mm) | 14     | 91     | 6/36 |
|               | 5/64" (2.0 mm) | 16     | 100    |      |
|               | 3/32" (2.4 mm) | 17     | 110    |      |
|               | 7/64" (2.8 mm) | 18     | 116    |      |
|               | 1/8" (3.2 mm)  | 19     | 123    |      |
|               | 9/64" (3.6 mm) | 20     | 130    |      |
|               | 5/32" (4.0 mm) | 21     | 132    |      |
|               | 3/16" (4.8 mm) | 24     | 150    |      |
|               | 7/32" (5.6 mm) | 25     | 165    |      |
|               | 1/4" (6.3 mm)  | 28     | 185    |      |
|               | 5/16" (7.9 mm) | 32     | 200    |      |
| 3/8" (9.5 mm) | 35             | 233    |        |      |

GB Hex key set  
 D Sechskant-Stiftschlüsselsatz  
 PL Zestaw kluczy imbusowych  
 RUS Набор шестигранников

CZ Imbusové klíče  
 H Imbisz kulcs  
 RO Chei imbus  
 F Set de clés Allen

I Set di chiavi a brugola  
 E Juego de llaves hex  
 CN 内六角扳手手套

PLASTIC HANGER  
 & SLIDING CARD



CrV  
 6150

HRC  
 52-55

5

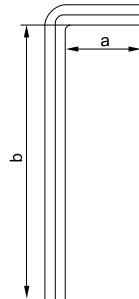

9  
 PCS

| YATO    | Ø (mm) | a (mm) | b (mm) |      |
|---------|--------|--------|--------|------|
| YT-0500 | 1.5    | 15     | 74     | 6/36 |
|         | 2.0    | 16     | 81     |      |
|         | 2.5    | 18     | 88     |      |
|         | 3.0    | 21     | 95     |      |
|         | 4.0    | 23     | 109    |      |
|         | 5.0    | 28     | 121    |      |
|         | 6.0    | 31     | 135    |      |
|         | 8.0    | 35     | 157    |      |
|         | 10.0   | 39     | 174    |      |

9  
 PCS

| YATO    | Ø (mm) | a (mm) | b (mm) |      |
|---------|--------|--------|--------|------|
| YT-0501 | 1.5    | 15     | 90     | 6/36 |
|         | 2.0    | 16     | 96     |      |
|         | 2.5    | 18     | 112    |      |
|         | 3.0    | 21     | 125    |      |
|         | 4.0    | 23     | 142    |      |
|         | 5.0    | 28     | 157    |      |
|         | 6.0    | 31     | 180    |      |
|         | 8.0    | 35     | 201    |      |
|         | 10.0   | 39     | 225    |      |

9  
 PCS

| YATO    | Ø (mm) | a (mm) | b (mm) |      |
|---------|--------|--------|--------|------|
| YT-0502 | 2.0    | 16     | 81     | 6/36 |
|         | 2.5    | 18     | 88     |      |
|         | 3.0    | 21     | 95     |      |
|         | 4.0    | 23     | 109    |      |
|         | 5.0    | 28     | 121    |      |
|         | 6.0    | 31     | 135    |      |
|         | 7.0    | 33     | 145    |      |
|         | 8.0    | 35     | 157    |      |
|         | 10.0   | 39     | 174    |      |

10  
 PCS

| YATO    | Ø (mm) | a (mm) | b (mm) |      |
|---------|--------|--------|--------|------|
| YT-0508 | 2.0    | 16     | 81     | 6/36 |
|         | 2.5    | 18     | 88     |      |
|         | 3.0    | 21     | 95     |      |
|         | 4.0    | 23     | 109    |      |
|         | 5.0    | 28     | 121    |      |
|         | 6.0    | 31     | 135    |      |
|         | 7.0    | 33     | 145    |      |
|         | 8.0    | 35     | 157    |      |
|         | 10.0   | 39     | 174    |      |
| 12.0    | 42     | 180    |        |      |

9  
 PCS

| YATO    | Ø (mm) | a (mm) | b (mm) |      |
|---------|--------|--------|--------|------|
| YT-0505 | 1.5    | 15     | 74     | 6/36 |
|         | 2.0    | 16     | 81     |      |
|         | 2.5    | 18     | 88     |      |
|         | 3.0    | 21     | 95     |      |
|         | 4.0    | 23     | 109    |      |
|         | 5.0    | 28     | 121    |      |
|         | 6.0    | 31     | 135    |      |
|         | 8.0    | 35     | 157    |      |
|         | 10.0   | 39     | 174    |      |

9  
 PCS

| YATO    | Ø (mm) | a (mm) | b (mm) |      |
|---------|--------|--------|--------|------|
| YT-0506 | 1.5    | 15     | 90     | 6/36 |
|         | 2.0    | 16     | 96     |      |
|         | 2.5    | 18     | 112    |      |
|         | 3.0    | 21     | 125    |      |
|         | 4.0    | 23     | 142    |      |
|         | 5.0    | 28     | 157    |      |
|         | 6.0    | 31     | 180    |      |
|         | 8.0    | 35     | 201    |      |
|         | 10.0   | 39     | 225    |      |

9  
 PCS

| YATO    | Ø (mm) | a (mm) | b (mm) |      |
|---------|--------|--------|--------|------|
| YT-0507 | 2.0    | 16     | 81     | 6/36 |
|         | 2.5    | 18     | 88     |      |
|         | 3.0    | 21     | 95     |      |
|         | 4.0    | 23     | 109    |      |
|         | 5.0    | 28     | 121    |      |
|         | 6.0    | 31     | 135    |      |
|         | 7.0    | 33     | 145    |      |
|         | 8.0    | 35     | 157    |      |
|         | 10.0   | 39     | 174    |      |

10  
 PCS

| YATO    | Ø (mm) | a (mm) | b (mm) |      |
|---------|--------|--------|--------|------|
| YT-0509 | 2.0    | 16     | 81     | 6/36 |
|         | 2.5    | 18     | 88     |      |
|         | 3.0    | 21     | 95     |      |
|         | 4.0    | 23     | 109    |      |
|         | 5.0    | 28     | 121    |      |
|         | 6.0    | 31     | 135    |      |
|         | 7.0    | 33     | 145    |      |
|         | 8.0    | 35     | 157    |      |
|         | 10.0   | 39     | 174    |      |
| 12.0    | 42     | 180    |        |      |

GB Hex key set  
 D Sechskant-Stiftschlüsselsatz  
 PL Zestaw kluczy imbusowych  
 RUS Набор шестигранников

CZ Imbusové klíče  
 H Imbisz kulcs  
 RO Chei imbus  
 F Set de clés Allen

I Set di chiavi a brugola  
 E Juego de llaves hex  
 CN 内六角扳手手套

POUCH



CrV  
 6150

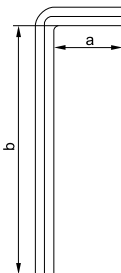

8  
 PCS

| YATO    | Ø (mm) | a (mm) | b (mm) |       |
|---------|--------|--------|--------|-------|
| YT-0503 | 2.0    | 14     | 50     | 12/72 |
|         | 2.5    | 16     | 53     |       |
|         | 3.0    | 17     | 60     |       |
|         | 4.0    | 21     | 66     |       |
|         | 5.0    | 22     | 74     |       |
|         | 6.0    | 27     | 81     |       |
|         | 8.0    | 32     | 93     |       |
|         | 10.0   | 38     | 104    |       |

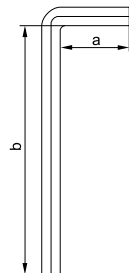

10  
 PCS

| YATO    | Ø (mm) | a (mm) | b (mm) |       |
|---------|--------|--------|--------|-------|
| YT-0504 | 1.5    | 12     | 43     | 12/72 |
|         | 2.0    | 14     | 50     |       |
|         | 2.5    | 16     | 53     |       |
|         | 3.0    | 17     | 60     |       |
|         | 4.0    | 21     | 66     |       |
|         | 5.0    | 22     | 74     |       |
|         | 6.0    | 27     | 81     |       |
|         | 7.0    | 31     | 86     |       |
|         | 8.0    | 32     | 93     |       |
|         | 10.0   | 38     | 104    |       |



- GB Hex key set  
D Sechskant-Stiftschlüsselsatz  
PL Zestaw kluczy imbusowych  
RUS Набор шестигранников  
CZ Imbusové klíče  
H Imbissz kulcs  
RO Chei imbus  
F Set de clés Allen  
I Set di chiavi a brugola  
E Juego de llaves hex  
CN 内六角扳手组套



10  
PCS



CrV  
6150

HRC  
52-55

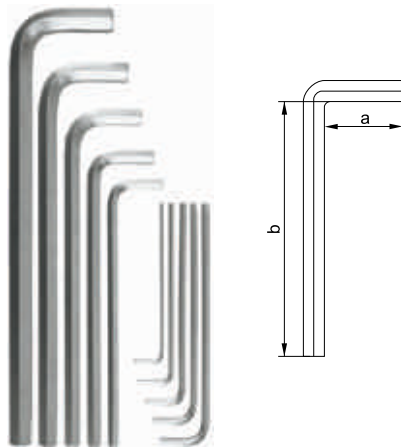

| YATO    | Ø (mm) | a (mm) | b (mm) |   |
|---------|--------|--------|--------|---|
| YT-0519 | 3.0    | 20     | 125    | 5 |
|         | 4.0    | 25     | 140    |   |
|         | 5.0    | 28     | 160    |   |
|         | 5.5    | 30     | 170    |   |
|         | 6.0    | 32     | 180    |   |
|         | 8.0    | 35     | 200    |   |
|         | 10.0   | 42     | 220    |   |
|         | 12.0   | 49     | 250    |   |
|         | 14.0   | 57     | 285    |   |
| 17.0    | 65     | 320    |        |   |

- GB TORX key set  
D TORX-Stiftschlüsselsatz  
PL Zestaw kluczy TORX  
RUS Набор ключей TORX  
CZ Souprava klíčů TORX  
H Kulcskészlet, TORX  
RO Set de chei TORX  
F Set de clés Allen  
I Set di chiavi a brugola  
E Juego de llaves TORX  
CN 内六角扳手组套

9  
PCS



CrV  
6150

HRC  
52-55

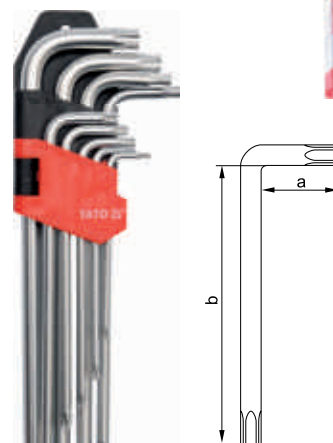

| YATO    | Ø   | a (mm) | b (mm) |      |
|---------|-----|--------|--------|------|
| YT-0511 | T10 | 15     | 72     | 6/36 |
|         | T15 | 16     | 79     |      |
|         | T20 | 17     | 86     |      |
|         | T25 | 21     | 94     |      |
|         | T27 | 24     | 107    |      |
|         | T30 | 27     | 122    |      |
|         | T40 | 32     | 133    |      |
|         | T45 | 36     | 155    |      |
|         | T50 | 38     | 174    |      |

| YATO    | Ø   | a (mm) | b (mm) |      |
|---------|-----|--------|--------|------|
| YT-0512 | T10 | 15     | 78     | 6/36 |
|         | T15 | 16     | 95     |      |
|         | T20 | 19     | 109    |      |
|         | T25 | 23     | 124    |      |
|         | T27 | 26     | 143    |      |
|         | T30 | 27     | 153    |      |
|         | T40 | 32     | 180    |      |
|         | T45 | 36     | 200    |      |
|         | T50 | 41     | 222    |      |

- GB Hex key set  
D Sechskant-Stiftschlüsselsatz  
PL Zestaw kluczy imbusowych  
RUS Набор шестигранников  
CZ Imbusové klíče  
H Imbissz kulcs  
RO Chei imbus  
F Set de clés Allen  
I Set di chiavi a brugola  
E Juego de llaves hex  
CN 内六角扳手组套

PLASTIC  
HANGER



S2



10  
PCS

| YATO    | Ø (mm) | a (mm) | b (mm) |       |
|---------|--------|--------|--------|-------|
| YT-0560 | 1.27   | 12     | 73     | 12/48 |
|         | 1.5    | 14     | 76     |       |
|         | 2.0    | 16     | 82     |       |
|         | 2.5    | 18     | 89     |       |
|         | 3.0    | 18     | 99     |       |
|         | 4.0    | 21     | 104    |       |
|         | 5.0    | 27     | 115    |       |
|         | 6.0    | 32     | 138    |       |
|         | 8.0    | 35     | 161    |       |
|         | 10.0   | 38     | 179    |       |

10  
PCS

| YATO    | Ø (mm) | a (mm) | b (mm) |       |
|---------|--------|--------|--------|-------|
| YT-0561 | 1.27   | 10     | 78     | 12/48 |
|         | 1.5    | 12     | 89     |       |
|         | 2.0    | 15     | 98     |       |
|         | 2.5    | 17     | 110    |       |
|         | 3.0    | 19     | 124    |       |
|         | 4.0    | 23     | 140    |       |
|         | 5.0    | 28     | 159    |       |
|         | 6.0    | 32     | 179    |       |
|         | 8.0    | 36     | 198    |       |
|         | 10.0   | 50     | 232    |       |

- GB TORX key set  
D TORX-Stiftschlüsselsatz  
PL Zestaw kluczy TORX  
RUS Набор ключей TORX  
CZ Souprava klíčů TORX  
H Kulcskészlet, TORX  
RO Set de chei TORX  
F Set de clés Allen  
I Set di chiavi a brugola  
E Juego de llaves TORX  
CN 内六角扳手组套

TORX TAMPERPROOF

PLASTIC  
HANGER



S2



7  
PCS

| YATO    | Ø   | a (mm) | b (mm) |       |
|---------|-----|--------|--------|-------|
| YT-0562 | T9  | 18     | 78     | 12/48 |
|         | T10 | 19     | 85     |       |
|         | T15 | 19     | 93     |       |
|         | T20 | 19     | 103    |       |
|         | T25 | 22     | 113    |       |
|         | T27 | 24     | 123    |       |
|         | T30 | 26     | 132    |       |

9  
PCS

| YATO    | Ø   | a (mm) | b (mm) |       |
|---------|-----|--------|--------|-------|
| YT-0563 | T10 | 14     | 87     | 12/48 |
|         | T15 | 14     | 97     |       |
|         | T20 | 16     | 108    |       |
|         | T25 | 18     | 123    |       |
|         | T27 | 23     | 137    |       |
|         | T30 | 27     | 158    |       |
|         | T40 | 30     | 177    |       |
|         | T45 | 35     | 197    |       |
|         | T50 | 41     | 216    |       |

# 6

## Pliers & pipe wrenches Szczypce i klucze do rur





**Pliers, CrV**  
**Szczypce, CrV**



121

|  |     |
|--|-----|
| Combination pliers<br>Szczypce uniwersalne.....      | 121 |
| Side cutting pliers<br>Szczypce tnące, boczne.....   | 121 |
| Long nose pliers<br>Szczypce wydłużone, proste.....  | 121 |
| Bent nose pliers<br>Szczypce wydłużone, wygięte..... | 121 |

**Pliers**  
**Szczypce**



121-122

|  |     |
|--|-----|
| Combination pliers<br>Szczypce uniwersalne.....              | 121 |
| Side cutting pliers<br>Szczypce tnące, boczne.....           | 121 |
| Long nose pliers<br>Szczypce wydłużone, proste.....          | 121 |
| Bent nose pliers<br>Szczypce wydłużone, wygięte.....         | 121 |
| Flat nose pliers<br>Szczypce płaskie.....                    | 122 |
| Round nose pliers<br>Szczypce okrągłe.....                   | 122 |
| Wire stripping pliers<br>Szczypce do ściągania izolacji..... | 122 |
| End cutting pliers<br>Szczypce tnące, czołowe.....           | 122 |

**Pliers, CrV**  
**Szczypce, CrV**



122

|  |     |
|--|-----|
| Combination pliers<br>Szczypce uniwersalne.....    | 122 |
| Side cutting pliers<br>Szczypce tnące, boczne..... | 122 |

**Pliers**  
**Szczypce**



123

|   |     |
|---|-----|
| Combination pliers<br>Szczypce uniwersalne.....     | 123 |
| Side cutting pliers<br>Szczypce tnące, boczne.....  | 123 |
| Long nose pliers<br>Szczypce wydłużone, proste..... | 123 |

**Mini pliers**  
**Szczypce „Mini”**



124

|  |     |
|--|-----|
| Combination pliers<br>Szczypce uniwersalne.....      | 124 |
| Side cutting pliers<br>Szczypce tnące, boczne.....   | 124 |
| Long nose pliers<br>Szczypce wydłużone, proste.....  | 124 |
| Bent nose pliers<br>Szczypce wydłużone, wygięte..... | 124 |
| Flat nose pliers<br>Szczypce płaskie.....            | 124 |
| Round nose pliers<br>Szczypce okrągłe.....           | 124 |

|  |     |
|--|-----|
| End cutting pliers<br>Szczypce tnące, czołowe..... | 124 |
|--|-----|

**Pliers, CrV**  
**Szczypce, CrV**



125

|   |     |
|---|-----|
| Combination pliers<br>Szczypce uniwersalne.....     | 125 |
| Long nose pliers<br>Szczypce wydłużone, proste..... | 125 |

**Insulated pliers**  
**Szczypce izolowane**



126

|  |     |
|--|-----|
| Combination pliers<br>Szczypce uniwersalne.....              | 126 |
| Side cutting pliers<br>Szczypce tnące, boczne.....           | 126 |
| Long nose pliers<br>Szczypce wydłużone, proste.....          | 126 |
| Bent nose pliers<br>Szczypce wydłużone, wygięte.....         | 126 |
| Wire stripping pliers<br>Szczypce do ściągania izolacji..... | 126 |

**Plastics & cables cutting pliers**  
**Szczypce do cięcia plastiku i kabli**



127

|   |     |
|---|-----|
| Side cutting pliers<br>Szczypce tnące, boczne.....  | 127 |
| Long nose pliers<br>Szczypce wydłużone, proste..... | 127 |

**Carpenter's pliers & tower pincers**  
**Obcęgi i szczypce**



128

|   |     |
|---|-----|
| Carpenter's pliers<br>Obcęgi.....         | 128 |
| Tower pincers<br>Szczypce tynkarskie..... | 128 |

**Heavy duty side cutting pliers**  
**Szczypce tnące, boczne**



128

|   |     |
|---|-----|
| End cutting pliers<br>Szczypce tnące czołowe..... | 128 |
|---|-----|

**Circlip pliers**  
**Szczypce Segera**



129-130



**Lock grip pliers**  
**Szczypce zaciskowe**



131-133

|  |     |
|--|-----|
| Lock grip pliers<br>Szczypce zaciskowe, uniwersalne..... | 131 |
|--|-----|



|   |  |   |
|---|--|---|
| <p><b>Welding locking pliers</b><br/>                 Szczypce zaciskowe, spawalnicze..... 132</p> <p><b>Flat locking pliers</b><br/>                 Szczypce zaciskowe o szerokich szczękach..... 132</p> <p><b>C-type welding locking pliers</b><br/>                 Szczypce zaciskowe, klamrowe typu „C”..... 132</p> <p><b>Chain locking pliers</b><br/>                 Szczypce zaciskowe z łańcuchem..... 132</p> <p><b>Self-locking multi grip pliers</b><br/>                 Szczypce blacharskie..... 133</p> | <p><b>Pipe wrenches</b><br/>                 Klucze do rur..... 134</p> <p><b>Chain pipe wrenches</b><br/>                 Klucze do rur łańcuchowe..... 134</p> |  |
| <p><b>Profile connection &amp; forming pliers</b><br/>                 Szczypce do łączenia i kształtowania profili..... 133</p>  | <p><b>Tweezers</b><br/>                 Pęsety..... 135</p>  |  |
| <p><b>Water pump pliers</b><br/>                 Szczypce nastawne..... 134</p>   |   |   |



GB Combination pliers  
D Kombinationszange  
PL Szczypce uniwersalne  
RUS Плоскогубцы универсальные  
CZ Kleště kombinované  
H Kombináltfogó

RO Patent universal  
F Pince universelle  
I Pinze universali  
E Alicates universales  
CN 钢丝钳

|                |                  |        |
|----------------|------------------|--------|
| 160 mm         | 180 mm           | 200 mm |
| HRC 44-50 BODY | HRC 58-62 CUTTER | CrV 55 |
| DIN 5746       |                  |        |



- application: industry
- induction hardening
- przeznaczenie: przemysł
- hartowane indukcyjnie

| YATO    | L (mm) |  |
|---------|--------|---|
| YT-1940 | 160    | 6/60  |
| YT-1941 | 180    | 6/60  |
| YT-1942 | 200    | 6/36  |

GB Diagonal side cutting pliers  
D Seitenschneider  
PL Szczypce tnące boczne  
RUS Бокорезы  
CZ Řezací kleště boční  
H Oldal csípőfogó

RO Olește tăietor  
F Pince à coupe latérale  
I Pinze taglianti laterali  
E Alicates corte lateral  
CN 斜嘴钳

|                  |        |                |
|------------------|--------|----------------|
| 160 mm           | 190 mm | HRC 44-50 BODY |
| HRC 58-62 CUTTER | CrV 55 | DIN 5746       |



- application: industry
- induction hardening
- przeznaczenie: przemysł
- hartowane indukcyjnie

| YATO    | L (mm) |  |
|---------|--------|---|
| YT-1947 | 160    | 6/60  |
| YT-1948 | 190    | 6/60  |

GB Long nose pliers  
D Radiozange  
PL Szczypce wydłużone proste  
RUS Тонкогубцы прямые  
CZ Prodloužené kleště rovné  
H Rádiófogó, egyenes

RO Clește cu vârf ascuțit  
F Pince prolongée  
I Pinze lunghe diritte  
E Alicates de punta  
CN 尖嘴钳

|                  |        |                |
|------------------|--------|----------------|
| 160 mm           | 200 mm | HRC 44-50 BODY |
| HRC 58-62 CUTTER | CrV 55 | DIN 5746       |



- application: industry
- induction hardening
- przeznaczenie: przemysł
- hartowane indukcyjnie

| YATO    | L (mm) |  |
|---------|--------|---|
| YT-1943 | 160    | 6/60  |
| YT-1944 | 200    | 6/60  |

GB Bent nose pliers  
D Telefonzange  
PL Szczypce wydłużone wygięte  
RUS Тонкогубцы изогнутые  
CZ Prodloužené kleště ohnuté  
H Rádió - és telefonfogó, hajlított

RO Clește cu vârf ascuțit indoit  
F Pince prolongée cambrée  
I Pinze a punta mezzo tonde  
E Alicates de punta curvos  
CN 弯嘴钳

|                  |        |                |
|------------------|--------|----------------|
| 160 mm           | 200 mm | HRC 44-50 BODY |
| HRC 58-62 CUTTER | CrV 55 | DIN 5746       |



- application: industry
- induction hardening
- przeznaczenie: przemysł
- hartowane indukcyjnie

| YATO    | L (mm) |  |
|---------|--------|---|
| YT-1945 | 160    | 6/60  |
| YT-1946 | 200    | 6/60  |

GB Combination pliers  
D Kombinationszange  
PL Szczypce uniwersalne  
RUS Плоскогубцы универсальные  
CZ Kleště kombinované  
H Kombináltfogó

RO Patent universal  
F Pince universelle  
I Pinze universali  
E Alicates universales  
CN 钢丝钳

|          |        |                    |
|----------|--------|--------------------|
| 160 mm   | 180 mm | 200 mm             |
| DIN 5746 |        | NICKEL IRON FINISH |



GB Long nose pliers  
D Radiozange  
PL Szczypce wydłużone proste  
RUS Тонкогубцы прямые  
CZ Prodloužené kleště rovné  
H Rádiófogó, egyenes

RO Clește cu vârf ascuțit  
F Pince prolongée  
I Pinze lunghe diritte  
E Alicates de punta  
CN 尖嘴钳

|          |                    |
|----------|--------------------|
| 160 mm   | 200 mm             |
| DIN 5746 | NICKEL IRON FINISH |



- application: industry
- induction hardening
- przeznaczenie: przemysł
- hartowane indukcyjnie

| YATO    | L (mm) |  |
|---------|--------|---|
| YT-2016 | 160    | 6/60  |
| YT-2018 | 200    | 6/60  |

GB Diagonal side cutting pliers  
D Seitenschneider  
PL Szczypce tnące boczne  
RUS Бокорезы  
CZ Řezací kleště boční  
H Oldal csípőfogó

RO Olește tăietor  
F Pince à coupe latérale  
I Pinze taglianti laterali  
E Alicates corte lateral  
CN 斜嘴钳

|          |                    |
|----------|--------------------|
| 160 mm   | 180 mm             |
| DIN 5746 | NICKEL IRON FINISH |



GB Bent nose pliers  
D Telefonzange  
PL Szczypce wydłużone wygięte  
RUS Тонкогубцы изогнутые  
CZ Prodloužené kleště ohnuté  
H Rádió - és telefonfogó, hajlított

RO Clește cu vârf ascuțit indoit  
F Pince prolongée cambrée  
I Pinze a punta mezzo tonde  
E Alicates de punta curvos  
CN 弯嘴钳

|          |                    |
|----------|--------------------|
| 160 mm   | 200 mm             |
| DIN 5746 | NICKEL IRON FINISH |





- application: industry
- induction hardening
- przeznaczenie: przemysł
- hartowane indukcyjnie

| YATO    | L (mm) |  |
|---------|--------|---|
| YT-2026 | 160    | 6/60  |
| YT-2028 | 200    | 6/60  |

- GB Flat nose pliers  
 D Elektrikerflachzange  
 PL Szczypce płaskie  
 RUS Утконосы  
 CZ Prodloužené kleště rovné  
 H Rádiófogó, egyenes
- RO Clește cu vârf ascuțit  
 F Pince plate  
 I Pinze piatte  
 E Alicates de bocas planas  
 CN 平嘴钳

**160 mm** **DIN 5745** **NICKEL IRON FINISH**





| YATO  | L (mm) |  |
|--|--------|---|
| YT-2029  | 160    | 6/60  |

- GB Round nose pliers  
 D Rundzange  
 PL Szczypce okrągłe  
 RUS Круглогубцы  
 CZ Kleště kulaté  
 H Kerekcsőrű fogó
- RO Patent rotund  
 F Pince ronde  
 I Pinze tonde  
 E Alicates de punta redonda  
 CN 圆嘴钳

**160 mm** **DIN 5745** **NICKEL IRON FINISH**





| YATO  | L (mm) |  |
|--|--------|---|
| YT-2030  | 160    | 6/60  |

- GB Wire stripping pliers  
 D Abisolierzange  
 PL Szczypce do ściągania izolacji  
 RUS Пасатижи для зачистки проводов  
 CZ Kleště odizolovací na drát  
 H Blankoló fogó  
 RO Decablator
- F Pince à l'isolation  
 I Pinze spelafili  
 E Pinzas pelacables  
 CN 剥线钳

**160 mm** **DIN 5745** **NICKEL IRON FINISH**





| YATO  | L (mm) |  |
|--|--------|---|
| YT-2031  | 160    | 6/60  |

- GB End cutting pliers  
 D Vornsneider  
 PL Szczypce tnące czolowe  
 RUS Кусачки торцевые  
 CZ Kleště štípací čelní  
 H Homlokcsipő fogó  
 RO Clește rețezat
- F Coupe devant  
 I Pinza a taglio laterale  
 E Cortacables frontales  
 CN 顶切钳

**160 mm** **180 mm**

**DIN 5748** **NICKEL IRON FINISH**





| YATO  | L (mm) |  |
|--|--------|---|
| YT-2066  | 160    | 6/60  |
| YT-2067  | 180    | 6/60  |

- GB Combination pliers  
 D Kombinationszange  
 PL Szczypce uniwersalne  
 RUS Плоскогубцы универсальные  
 CZ Kleště kombinované  
 H Kombináltfogó
- RO Patent universal  
 F Pince universelle  
 I Pinze universali  
 E Alicates universales  
 CN 钢丝钳

**160 mm** **180 mm** **200 mm**

**CrV** **HRC 55-62**





| YATO  | L (mm) |  |
|--|--------|---|
| YT-6600  | 160    | 6/60  |
| YT-6601  | 180    | 6/60  |
| YT-6602  | 200    | 6/36  |

- GB Diagonal side cutting pliers  
 D Seitenschneider  
 PL Szczypce tnące boczne  
 RUS Бокорезы  
 CZ Řezací kleště boční  
 H Oldal csipőfogó
- RO Olește tăietor  
 F Pince à coupe latérale  
 I Pinze taglianti laterali  
 E Alicates corte lateral  
 CN 斜嘴钳

**160 mm** **180 mm**



**CrV** **HRC 55-62**



| YATO  | L (mm) |  |
|--|--------|---|
| YT-6610  | 160    | 6/60  |
| YT-6611  | 180    | 6/60  |

- GB Diagonal side cutting pliers  
 D Seitenschneider  
 PL Szczypce tnące boczne  
 RUS Бокорезы  
 CZ Řezací kleště boční  
 H Oldal csipőfogó  
 RO Olește tăietor  
 F Pince à coupe latérale  
 I Pinze taglianti laterali  
 E Alicates corte lateral  
 CN 斜嘴钳



| YATO  | L (mm) |  |
|--|--------|---|
| YT-6612  | 180    | 6/60  |



- GB Combination pliers  
D Kombinationszange  
PL Szczypce uniwersalne  
RUS Плоскогубцы универсальные  
CZ Kleště kombinované  
H Kombináltfogó
- RO Patent universal  
F Pince universelle  
I Pinze universali  
E Alicates universales  
CN 钢丝钳

160  
mm

200  
mm



HIGH  
LEVERAGE  
ZWIĘKSZONA  
SIŁA NACISKU



HALF  
DOUBLE  
BLISTER



6

| YATO  | L (mm) |  |
|--|--------|---|
| YT-6581  | 160    | 6/60  |
| YT-6582  | 200    | 6/36  |

- GB Diagonal side cutting pliers  
D Seitenschneider  
PL Szczypce tnące boczne  
RUS Бокорезы  
CZ Řezací kleště boční  
H Oldal csípőfogó
- RO Olește tăietor  
F Pince à coupe latérale  
I Pinze taglianti laterali  
E Alicates corte lateral  
CN 斜嘴钳



160  
mm

HIGH  
LEVERAGE  
ZWIĘKSZONA  
SIŁA NACISKU



HALF  
DOUBLE  
BLISTER



| YATO  | L (mm) |  |
|--|--------|---|
| YT-6583  | 160    | 6/60  |

- GB Long nose pliers  
D Radiozange  
PL Szczypce wydłużone proste  
RUS Тонкогубцы прямые  
CZ Prodloužené kleště rovné  
H Rádiófogó, egyenes
- RO Clește cu vârf ascuțit  
F Pince prolongée  
I Pinze lunghe diritte  
E Alicates de punta  
CN 尖嘴钳

160  
mm



200  
mm

HIGH  
LEVERAGE  
ZWIĘKSZONA  
SIŁA NACISKU



HALF  
DOUBLE  
BLISTER



| YATO  | L (mm) |  |
|--|--------|---|
| YT-6586  | 160    | 6/60  |
| YT-6587  | 200    | 6/36  |

GB Combination pliers  
D Kombinationszange  
PL Szczypce uniwersalne  
RUS Плоскогубцы универсальные  
CZ Kleště kombinované  
H Kombináltfogó  
RO Patent universal  
F Pince universelle

I Pinze universali  
E Alicates universales  
CN 钢丝钳

115 mm

NICKEL IRON FINISH



HALF DOUBLE BLISTER

YATO L (mm) 6/120  
YT-2080 115 6/120

GB Diagonal side cutting pliers  
D Seitenschneider  
PL Szczypce tnące boczne  
RUS Бокорезы  
CZ Řezací kleště boční  
H Oldal csípőfogó  
RO Olește tăietor  
F Pince à coupe latérale

I Pinze taglianti laterali  
E Alicates corte lateral  
CN 斜嘴钳

115 mm

NICKEL IRON FINISH



HALF DOUBLE BLISTER

YATO L (mm) 6/120  
YT-2081 115 6/120

GB Long nose pliers  
D Radiozange  
PL Szczypce wydłużone proste  
RUS Тонкогубцы прямые  
CZ Prodloužené kleště rovné  
H Rádiófogó, egyenes

RO Clește cu vârf ascuțit  
F Pince prolongée  
I Pinze lunghe diritte  
E Alicates de punta  
CN 尖嘴钳

115 mm

NICKEL IRON FINISH



HALF DOUBLE BLISTER

YATO L (mm) 6/120  
YT-2083 115 6/120

GB Bent nose pliers  
D Telefonzange  
PL Szczypce wydłużone wygięte  
RUS Тонкогубцы изогнутые  
CZ Prodloužené kleště ohnuté  
H Rádió - és telefonfogó, hajlított

RO Clește cu vârf ascuțit îndoit  
F Pince prolongée cambrée  
I Pinze a punte mezza tonda  
E Alicates de punta curvos  
CN 弯嘴钳

115 mm

NICKEL IRON FINISH

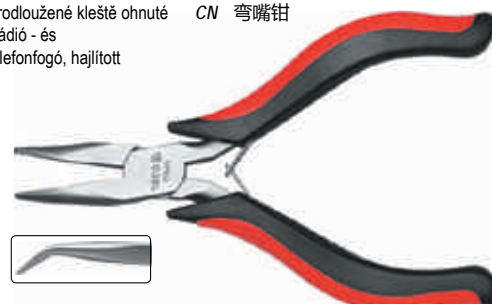

HALF DOUBLE BLISTER

YATO L (mm) 6/120  
YT-2084 115 6/120

GB Flat nose pliers  
D Elektrikerflachzange  
PL Szczypce płaskie  
RUS Утконосы  
CZ Prodloužené kleště rovné  
H Rádiófogó, egyenes

RO Clește cu vârf ascuțit  
F Pince plate  
I Pinze piatte  
E Alicates de bocas planas  
CN 平嘴钳

115 mm

NICKEL IRON FINISH



HALF DOUBLE BLISTER

YATO L (mm) 6/120  
YT-2085 115 6/120

GB Round nose pliers  
D Rundzange  
PL Szczypce okrągłe  
RUS Круглогубцы  
CZ Kleště kulaté  
H Kerekcsőrű fogó

RO Patent rotund  
F Pince ronde  
I Pinze tonde  
E Alicates de punta redonda  
CN 圆嘴钳

115 mm

NICKEL IRON FINISH



HALF DOUBLE BLISTER

YATO L (mm) 6/120  
YT-2086 115 6/120

GB End cutting pliers  
D Vornschnaider  
PL Szczypce tnące czolowe  
RUS Кусачки торцевые  
CZ Kleště štípací čelní  
H Homlokcsípő fogó  
RO Clește retezat  
F Coupe devant  
I Pinza a taglio laterale  
E Cortacables frontales  
CN 顶切钳



115 mm

NICKEL IRON FINISH

HALF DOUBLE BLISTER

YATO L (mm) 6/120  
YT-2082 115 6/120





- GB Combination pliers  
D Kombinationszange  
PL Szczypce uniwersalne  
RUS Плоскогубцы универсальные  
CZ Kleště kombinované  
H Kombináltfogó
- RO Patent universal  
F Pince universelle  
I Pinze universali  
E Alicates universales  
CN 钢丝钳

160 mm 200 mm CrV HRC 56-62



SLIDING CARD 

| YATO  | L (mm) |  |
|--|--------|---|
| YT-6620  | 160    | 6/60  |
| YT-6622  | 200    | 6/36  |



6

- GB Long nose pliers  
D Radiozange  
PL Szczypce wydłużone proste  
RUS Тонкогубцы прямые  
CZ Prodloužené kleště rovné  
H Rádiófogó, egyenes
- RO Clește cu vârf ascuțit  
F Pince prolongée  
I Pinze lunghe diritte  
E Alicates de punta  
CN 尖嘴钳

200 mm CrV HRC 56-62



SLIDING CARD 



| YATO  | L (mm) |  |
|--|--------|---|
| YT-6624  | 200    | 6/36  |

- GB Long nose pliers  
D Radiozange  
PL Szczypce wydłużone proste  
RUS Тонкогубцы прямые  
CZ Prodloužené kleště rovné  
H Rádiófogó, egyenes
- RO Clește cu vârf ascuțit  
F Pince prolongée  
I Pinze lunghe diritte  
E Alicates de punta  
CN 尖嘴钳

160 mm CrV HRC 56-62



SLIDING CARD 



| YATO  | L (mm) |  |
|--|--------|---|
| YT-6625  | 160    | 6/60  |

- GB Long nose pliers  
D Radiozange  
PL Szczypce wydłużone proste  
RUS Тонкогубцы прямые  
CZ Prodloužené kleště rovné  
H Rádiófogó, egyenes
- RO Clește cu vârf ascuțit  
F Pince prolongée  
I Pinze lunghe diritte  
E Alicates de punta  
CN 尖嘴钳

160 mm CrV HRC 56-62



SLIDING CARD 

| YATO  | L (mm) |  |
|--|--------|---|
| YT-6626  | 160    | 6/60  |

- GB Combination pliers
- D Kombinationszange
- PL Szczypce uniwersalne
- RUS Плоскогубцы универсальные
- CZ Kleště kombinované
- H Kombináltfogó
- RO Patent universal
- F Pince universelle
- I Pinze universali
- E Alicates universales
- CN 钢丝钳

**160 mm** **180 mm** **200 mm** **1000 V** **DIN 5746** **CrV**



05 VDE  
CERTIFICATE  
-IEC60900:2004

HALF  
DOUBLE  
BLISTER

| YATO    | L (mm) |      |
|---------|--------|------|
| YT-2101 | 160    | 6/60 |
| YT-2102 | 180    | 6/60 |
| YT-2103 | 200    | 6/60 |

- GB Diagonal side cutting pliers
- D Seitenschneider
- PL Szczypce tnące boczne
- RUS Бокорезы
- CZ Řezací kleště boční
- H Oldal csípőfogó
- RO Olește tăietor
- F Pince à coupe latérale
- I Pinze taglianti laterali
- E Alicates corte lateral
- CN 斜嘴钳

**160 mm** **1000 V** **DIN 5749** **CrV**



05 VDE  
CERTIFICATE  
-EN60900:2004

HALF  
DOUBLE  
BLISTER

| YATO    | L (mm) |      |
|---------|--------|------|
| YT-2109 | 160    | 6/60 |

- GB Diagonal side cutting pliers
- D Seitenschneider
- PL Szczypce wydużone boczne
- RUS Бокорезы
- CZ Řezací kleště boční
- H Oldal csípőfogó
- RO Olește tăietor
- F Pince à coupe latérale
- I Pinze taglianti laterali
- E Alicates corte lateral
- CN 斜嘴钳

**180 mm** **1000 V** **DIN 5749** **CrV**



05 VDE  
CERTIFICATE  
-EN60900:2004

HALF  
DOUBLE  
BLISTER

| YATO    | L (mm) |      |
|---------|--------|------|
| YT-2110 | 180    | 6/60 |

- GB Long nose pliers
- D Radiozange
- PL Szczypce wydłużone proste
- RUS Тонкогубцы прямые
- CZ Prodloužené kleště rovné
- H Rádiófogó, egyenes
- RO Clește cu vârf ascuțit
- F Pince prolongée
- I Pinze lunghe diritte
- E Alicates de punta
- CN 尖嘴钳

**160 mm** **200 mm** **1000 V** **DIN 5745** **CrV**



05 VDE  
CERTIFICATE  
-EN60900:2004

HALF  
DOUBLE  
BLISTER

| YATO    | L (mm) |      |
|---------|--------|------|
| YT-2104 | 160    | 6/60 |
| YT-2105 | 200    | 6/60 |

- GB Bent nose pliers
- D Telefonzange
- PL Szczypce wydłużone wygięte
- RUS Тонкогубцы изогнутые
- CZ Prodloužené kleště ohnuté
- H Rádió - és telefonfogó, hajlított
- RO Clește cu vârf ascuțit îndoit
- F Pince prolongée cambrée
- I Pinze a punte mezzo tonde
- E Alicates de punta curvos
- CN 弯嘴钳

**200 mm** **1000 V** **DIN 5745** **CrV**



05 VDE  
CERTIFICATE  
-EN60900:2004

HALF  
DOUBLE  
BLISTER

| YATO    | L (mm) |      |
|---------|--------|------|
| YT-2107 | 200    | 6/60 |

- GB Wire stripping pliers
- D Abisolierzange
- PL Szczypce do ściągania izolacji
- RUS Пасатижи для зачистки проводов
- CZ Kleště odizolovací na drát
- H Blankoló fogó
- RO Decablator
- F Pince à l'isolation
- I Pinze spelafili
- E Pinzas pelacables
- CN 剥线钳

**160 mm** **1000 V** **DIN 5745** **CrV**



05 VDE  
CERTIFICATE  
-EN60900:2004

HALF  
DOUBLE  
BLISTER

| YATO    | L (mm) |      |
|---------|--------|------|
| YT-2112 | 160    | 6/60 |



GB Diagonal side cutting pliers  
D Seitenschneider  
PL Szczypce tnące boczne  
RUS Бокорезы  
CZ Řezací kleště boční  
H Oldal csípőfogó

RO Olește tăietor  
F Pince à coupe latérale  
I Pinze taglianti laterali  
E Alicates corte lateral  
CN 斜嘴钳

125 mm CrV 60  
HRC CUTTER 56-62 HRC BODY 43-48  
FOR PLASTIC max. ∅ 3 mm



SLIDING CARD

YATO L (mm) 6/120  
YT-1950 125 6/120

GB Diagonal side cutting pliers  
D Seitenschneider  
PL Szczypce tnące boczne  
RUS Бокорезы  
CZ Řezací kleště boční  
H Oldal csípőfogó

RO Olește tăietor  
F Pince à coupe latérale  
I Pinze taglianti laterali  
E Alicates corte lateral  
CN 斜嘴钳

150 mm CrV 60  
HRC CUTTER 56-62 HRC BODY 43-48  
FOR PLASTIC max. ∅ 5 mm



SLIDING CARD

YATO L (mm) 6/120  
YT-1951 150 6/120

GB Diagonal side cutting pliers  
D Seitenschneider  
PL Szczypce tnące boczne  
RUS Бокорезы  
CZ Řezací kleště boční  
H Oldal csípőfogó

RO Olește tăietor  
F Pince à coupe latérale  
I Pinze taglianti laterali  
E Alicates corte lateral  
CN 斜嘴钳

180 mm CrV 60  
HRC CUTTER 56-62 HRC BODY 43-48  
FOR PLASTIC max. ∅ 6 mm



SLIDING CARD

YATO L (mm) 6/60  
YT-1952 180 6/60

GB Diagonal side cutting pliers  
D Seitenschneider  
PL Szczypce tnące boczne  
RUS Бокорезы  
CZ Řezací kleště boční  
H Oldal csípőfogó

RO Olește tăietor  
F Pince à coupe latérale  
I Pinze taglianti laterali  
E Alicates corte lateral  
CN 斜嘴钳

100 mm CrV 60  
HRC CUTTER 56-62 HRC BODY 43-48  
FOR CABLE CUTTING max. ∅ 1.0 mm  
COPPER max. ∅ 1.8 mm



SLIDING CARD

YATO L (mm) 6/120  
YT-1953 100 6/120

GB Diagonal side cutting pliers  
D Seitenschneider  
PL Szczypce tnące boczne  
RUS Бокорезы  
CZ Řezací kleště boční  
H Oldal csípőfogó

RO Olește tăietor  
F Pince à coupe latérale  
I Pinze taglianti laterali  
E Alicates corte lateral  
CN 斜嘴钳

125 mm CrV 60  
HRC CUTTER 56-62 HRC BODY 43-48  
FOR CABLE CUTTING max. ∅ 2.0 mm  
STEEL max. ∅ 1.2 mm  
COPPER max. ∅ 2.0 mm



SLIDING CARD

YATO L (mm) 6/120  
YT-1954 125 6/120

GB Long nose pliers  
D Radiozange  
PL Szczypce wydłużone proste  
RUS Тонкогубцы прямые  
CZ Prodloužené kleště rovné  
H Rádiófogó, egyenes

RO Clește cu vârf ascuțit  
F Pince prolongée  
I Pinze lunghe diritte  
E Alicates de punta  
CN 尖嘴钳

150 mm CrV 60  
HRC CUTTER 56-62 HRC BODY 43-48  
STEEL max. ∅ 1.5 mm  
COPPER max. ∅ 2.6 mm



SLIDING CARD

YATO L (mm) 6/120  
YT-1956 150 6/120

GB Carpenter's pliers  
D Kneifzange  
PL Obcegi  
RUS Клещи строительные

CZ Kleště  
H Harapófógó  
RO Cleste cuie  
F Tenailles

I Tenaglie  
E Tenazas  
CN 胡桃钳

160 mm 180 mm 200 mm DIN 5748 NICKEL IRON FINISH



HALF DOUBLE BLISTER



| YATO    | L (mm) |      |
|---------|--------|------|
| YT-2046 | 160    | 6/60 |
| YT-2047 | 180    | 6/60 |
| YT-2048 | 200    | 6/60 |

GB Tower pincers  
D Beisszange  
PL Obcegi tynkarskie  
RUS Клещи штукатурные

CZ Kleště štípací čelní  
H Rabitzfógó  
RO Cleste pt. cuie  
F Tenaille russe

I Tenaglie tronchesi  
E Tenazas de enlucido  
CN 扎线钳

200 mm 250 mm 275 mm DIN 5748 NICKEL IRON FINISH



HALF DOUBLE BLISTER



| YATO    | L (mm) |      |
|---------|--------|------|
| YT-2058 | 200    | 6/60 |
| YT-2060 | 250    | 6/36 |
| YT-2061 | 275    | 6/36 |

GB Tower pincers  
D Beisszange  
PL Obcegi tynkarskie  
RUS Клещи штукатурные

CZ Kleště štípací čelní  
H Rabitzfógó  
RO Cleste pt. cuie  
F Tenaille russe

I Tenaglie tronchesi  
E Tenazas de enlucido  
CN 扎线钳

250 mm HRC 44-50 BODY HRC 58-62 CUTTER CrV 55 DIN 5746



HALF DOUBLE BLISTER



| YATO    | L (mm) |      |
|---------|--------|------|
| YT-1949 | 250    | 6/36 |

GB Heavy duty side cutting pliers  
D Seitenschneider, Schwer Typ  
PL Szczypce tnące boczne  
RUS Бокорезы усиленные  
CZ Řezací kleště boční

H Oldal csípófógó  
RO Olește tăietor  
F Pince à coupe latérale  
I Pinze taglianti laterali

E Alicates de corte lateral tipo pesado  
CN 重型斜口钳

180 mm DIN 5749 NICKEL IRON FINISH



HALF DOUBLE BLISTER



| YATO    | L (mm) |      |
|---------|--------|------|
| YT-2039 | 180    | 6/60 |

GB Carpenter's pliers  
D Kneifzange  
PL Obcegi  
RUS Клещи строительные

CZ Kleště  
H Harapófógó  
RO Cleste cuie  
F Tenailles

I Tenaglie  
E Tenazas  
CN 胡桃钳

150 mm 175 mm 200 mm CrV 50 HRC 55-60 HEAD GLOWECA



SLIDING CARD



| YATO    | L (mm) | cold rolled steel (mm)<br>stal walcowana na zimno (mm) |      |
|---------|--------|--|------|
| YT-2050 | 150    | 1.5  | 6/60 |
| YT-2051 | 175    | 1.8  | 6/60 |
| YT-2052 | 200    | 2.0  | 6/48 |

GB Tower pincers  
D Beisszange  
PL Obcegi tynkarskie  
RUS Клещи штукатурные

CZ Kleště štípací čelní  
H Rabitzfógó  
RO Cleste pt. cuie  
F Tenaille russe

I Tenaglie tronchesi  
E Tenazas de enlucido  
CN 扎线钳

225 mm 250 mm 275 mm CrV 50 HRC 55-62 HEAD GLOWECA



SLIDING CARD



| YATO    | L (mm) | cold rolled steel (mm)<br>stal walcowana na zimno (mm) |      |
|---------|--------|--|------|
| YT-2055 | 225    | 1.8  | 6/60 |
| YT-2056 | 250    | 2.0  | 6/48 |
| YT-2057 | 275    | 2.2  | 6/24 |

GB End cutting pliers  
D Vornschneider  
PL Szczypce tnące czołowe

RUS Кусачки торцевые  
CZ Kleště štípací čelní  
H Homlokcsípó fogó

RO Cleste retezat  
F Coupe devant  
I Pinza a taglio laterale

E Cortacables frontales  
CN 顶切钳

150 mm 175 mm 200 mm CrV 50 HRC 55-60 HEAD GLOWECA





SLIDING CARD







| YATO    | L (mm) | cold rolled steel (mm)<br>stal walcowana na zimno (mm) |      |
|---------|--------|--|------|
| YT-2063 | 175    | 1.5  | 6/48 |
| YT-2064 | 200    | 1.8  | 6/48 |



- GB Circlip pliers  
D Seegeringgzange  
PL Szczypce Segera  
RUS Съёмник стопорных колец  
CZ Kleště Segera  
H Segerfogó belső  
RO Clește Seger
- F Pince pour anneau de retenue seeger  
I Pinze Seger  
E Alicates Seger  
CN 5件套卡簧钳

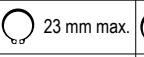
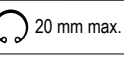

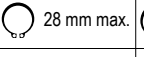
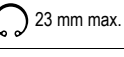
|   |   |               |
|---|---|---------------|
| 5<br>PCS  | 160<br>mm   | ∅ mm<br>10-50 |
|  |  |               |

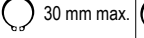
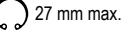

|   |   |            |   |            |
|---|---|------------|---|------------|
|  |  | 23 mm max. |  | 20 mm max. |
|  |  | 28 mm max. |  | 23 mm max. |
|  |  | 30 mm max. |  | 27 mm max. |



SLIDING CARD



|   |        |   |
|---|--------|---|
| <b>YATO</b>  | L (mm) |  |
| YT-2130   | 160    | 20/60   |



- GB Circlip pliers  
D Seegeringgzange  
PL Szczypce Segera  
RUS Съёмник стопорных колец  
CZ Kleště Segera  
H Segerfogó belső
- RO Clește Seger  
F Pince pour anneau de retenue seeger  
I Pinze Seger  
E Alicates Seger  
CN 直嘴轴用挡圈钳





|           |              |           |
|-----------|--------------|-----------|
| 180<br>mm | HRC<br>42-48 | CrV<br>50 |
|-----------|--------------|-----------|





|   |        |   |
|---|--------|---|
| <b>YATO</b>  | L (mm) |  |
| YT-2136   | 180    | 6/24  |

|   |        |   |
|---|--------|---|
| <b>YATO</b>  | L (mm) |  |
| YT-2138   | 180    | 6/24  |



|   |        |   |
|---|--------|---|
| <b>YATO</b>  | L (mm) |  |
| YT-2137   | 180    | 6/24  |

|   |        |   |
|---|--------|---|
| <b>YATO</b>  | L (mm) |  |
| YT-2139   | 180    | 6/24  |

GB Circlip pliers  
 D Seegeringgzange  
 PL Szczypce Segera  
 RUS Съёмник стопорных колец  
 CZ Kleště Segera  
 H Segerfogó béső  
 RO Clește Seger  
 F Pince pour anneau de retenue seeger  
 I Pinze Seger  
 E Alicates Seger  
 CN 直嘴轴用挡圈钳

SLIDING CARD



**150 mm**  
**200 mm**  
**CrV**  
**NICKEL IRON FINISH**



| YATO    | L (mm) |       |
|---------|--------|-------|
| YT-2140 | 150    | 6/120 |
| YT-2144 | 200    | 6/60  |



| YATO    | L (mm) |       |
|---------|--------|-------|
| YT-2141 | 150    | 6/120 |
| YT-2145 | 200    | 6/60  |



| YATO    | L (mm) |      |
|---------|--------|------|
| YT-2142 | 150    | 6/60 |
| YT-2146 | 200    | 6/60 |



| YATO    | L (mm) |       |
|---------|--------|-------|
| YT-2143 | 150    | 6/120 |
| YT-2147 | 200    | 6/60  |

GB Circlip pliers  
 D Seegeringgzange  
 PL Szczypce Segera  
 RUS Съёмник стопорных колец  
 CZ Kleště Segera  
 H Segerfogó béső  
 RO Clește Seger  
 F Pince pour anneau de retenue seeger  
 I Pinze Seger  
 E Alicates Seger  
 CN 直嘴轴用挡圈钳

SLIDING CARD



**225 mm**  
**325 mm**  
**NICKEL FINISH**  
**CrV**



| YATO    | L (mm) |      |
|---------|--------|------|
| YT-1988 | 225    | 6/60 |
| YT-1992 | 325    | 6/48 |



| YATO    | L (mm) |      |
|---------|--------|------|
| YT-1989 | 225    | 6/60 |
| YT-1993 | 325    | 6/48 |



| YATO    | L (mm) |      |
|---------|--------|------|
| YT-1990 | 225    | 6/60 |
| YT-1994 | 325    | 6/48 |



| YATO    | L (mm) |      |
|---------|--------|------|
| YT-1991 | 225    | 6/60 |
| YT-1995 | 325    | 6/48 |



GB Lock grip pliers  
D Gripzange  
PL Szczypce Morse'a  
RUS Зажим ручной  
CZ Kleště Morse'a  
H Morse fogó

RO Clește Morse  
F Pincés de serrage Morse  
I Pinze Morse  
E Alicates Morse  
CN 圓口大力鉗

HALF  
DOUBLE  
BLISTER



140  
mm

240  
mm

180  
mm

WR  
TYPE







165  
mm

220  
mm

CD  
TYPE

CrV

| YATO  | L (mm) |  |
|--|--------|---|
| YT-2151  | 140    | 6/48  |
| YT-2152  | 180    | 6/36  |
| YT-2153  | 240    | 6/36  |

| YATO  | L (mm) |  |
|--|--------|---|
| YT-2155  | 165    | 6/48  |
| YT-2156  | 220    | 6/36  |

GB Locking pliers  
D Klemmzange  
PL Szczypce zaciskowe  
RUS Клещи давящие  
CZ Kleště samosvorné  
H Patentfogó

RO Clește de strângere  
F Pincés de serrage Morse  
I Pinze Morse  
E Pinzas de tornillo (de apriete)  
CN 圓口大力鉗

HALF  
DOUBLE  
BLISTER





125  
mm





250  
mm

CrMo

6

| YATO  | L (mm) |  |
|--|--------|---|
| YT-2449  | 125    | 6/24  |



| YATO  | L (mm) |  |
|--|--------|---|
| YT-2453  | 250    | 6/24  |





180  
mm



150  
mm

| YATO  | L (mm) |  |
|--|--------|---|
| YT-2450  | 180    | 6/24  |



| YATO  | L (mm) |  |
|--|--------|---|
| YT-2459  | 150    | 6/24  |





250  
mm





225  
mm

| YATO  | L (mm) |  |
|--|--------|---|
| YT-2451  | 250    | 6/24  |

| YATO  | L (mm) |  |
|--|--------|---|
| YT-2460  | 225    | 6/24  |



180  
mm

| YATO  | L (mm) |  |
|--|--------|---|
| YT-2452  | 180    | 6/24  |

- GB Locking pliers  
 D Klemmzange  
 PL Szczypce zaciskowe  
 RUS Клещи давящие  
 CZ Kleště samosvorné  
 H Patentfogó  
 RO Clește de strângere

- F Pince de serrage courte avec blocage  
 I Pinze di bloccaggio  
 E Pinzas de tornillo (de apriete)  
 CN 大力钳

HALF DOUBLE BLISTER

CrMo



250 mm

0-42 mm

| YATO    | L (mm) |      |
|---------|--------|------|
| YT-2473 | 250    | 6/24 |



250 mm

0-42 mm

| YATO    | L (mm) |      |
|---------|--------|------|
| YT-2476 | 250    | 6/24 |

- GB C-type welding locking pliers  
 D Klemm- und Klammerzange vom Typ „C“  
 PL Szczypce zaciskowe klamrowe typu „C“  
 RUS Клещи давящие типа „C“  
 CZ Kleště samosvorné upínací typu „C“  
 H „C“ fogó

- RO Clește de strângere cu clemă tip „C“  
 F Pince de serrage type „C“  
 I Pinze di bloccaggio tipo „C“  
 E Pinzas de tornillo (de apriete) de grapa tipo „C“  
 CN C型大力钳

HALF DOUBLE BLISTER

280 mm

0-100 mm

TYPE C



| YATO    | L (mm) |      |
|---------|--------|------|
| YT-2466 | 280    | 6/24 |

| YATO    | L (mm) |      |
|---------|--------|------|
| YT-2468 | 280    | 6/24 |

- GB Chain locking pliers  
 D Klemmzange mit Kette  
 PL Szczypce zaciskowe z łańcuchem  
 RUS Клещи давящие с цепью  
 CZ Kleště samosvorné s řetězem  
 H Láncos csőfogó  
 RO Clește de strângere cu lanț  
 F Pince de serrage avec une chaîne  
 I Pinze di bloccaggio con la catena  
 E Pinzas de tornillo (de apriete) con cadena  
 CN 链条大力钳



HALF DOUBLE BLISTER

500 mm

40 Mn



| YATO    |  |      |
|---------|--|------|
| YT-2469 |  | 6/24 |



- GB Self-locking multi grip pliers  
D Grip-Festhaltezange  
PL Szczypce blacharskie  
RUS Зажим ручной сварочный для закрепления лент и профилей  
CZ Kleště klempířské samodržící  
H Őnzáró rögzítőfogó  
RO Cleste autoblocant pt. tinichigerie  
F Pince pour tôle  
I Pinze per lamiera  
E Pinzas de chapa  
CN 多功能大力钳

SLIDING CARD



CrMo



200 mm 0-15 mm 70 mm TYPE W

|             |        |   |
|-------------|--------|---|
| <b>YATO</b> | L (mm) |  |
| YT-2160     | 200    | 12/24   |



230 mm 0-15 mm 45 mm TYPE JJ

|             |        |   |
|-------------|--------|---|
| <b>YATO</b> | L (mm) |  |
| YT-2161     | 230    | 12/24   |



215 mm 0-10 mm 45 mm TYPE LL

|             |        |   |
|-------------|--------|---|
| <b>YATO</b> | L (mm) |  |
| YT-2162     | 215    | 12/36   |



210 mm 0-15 mm 25 mm TYPE J

|             |        |   |
|-------------|--------|---|
| <b>YATO</b> | L (mm) |  |
| YT-2163     | 210    | 12/36   |

- GB Profile connection pliers  
D Zange zum Verbinden der Profile  
PL Szczypce do łączenia profili  
RUS Щипцы для соединения профилей  
CZ Kleště ke spojování profilů  
H Profílegyesítő fogó  
RO Cleste pt. îmbinarea profilelor  
F Pince pour sertir les profiles  
I Pinze per la unione profili  
E Pinzas para conectar perfiles  
CN 龙骨钳

SLIDING CARD



SECTION THICKNESS GRUBOSC PROFILU 0,5-0,8 mm

275 mm

A380 Al-Ti ALLOY (HEAD)

GR15 BEARING STEEL (PUNCH)



|             |        |   |
|-------------|--------|---|
| <b>YATO</b> | L (mm) |  |
| YT-5130     | 275    | 6/24  |

345 mm

65 Mn MATERIAL OF PUNCH PUNKTAK



|             |        |  |
|-------------|--------|--|
| <b>YATO</b> | L (mm) |  |
| YT-5131     | 345    | 6/24   |

- GB Profile forming pliers  
D Zange zur Formgebung der Profile  
PL Szczypce do kształtowania profili  
RUS Щипцы для формировки профилей  
CZ Kleště k tvarování profilů  
H Profilformázó fogó  
RO Cleste pt. modelarea profilelor  
F Pince pour former les profiles  
I Pinze per la formazione di profili  
E Pinzas para formar perfiles  
CN 龙骨钳

SLIDING CARD



210 mm

80x35 mm JAWS SZCZĘKI



|             |        |   |
|-------------|--------|---|
| <b>YATO</b> | L (mm) |  |
| YT-5140     | 210    | 2/12  |

80x35 mm JAWS SZCZĘKI



|             |        |   |
|-------------|--------|---|
| <b>YATO</b> | L (mm) |  |
| YT-5141     | 210    | 2/12  |

150x35 mm JAWS SZCZĘKI



|             |        |   |
|-------------|--------|---|
| <b>YATO</b> | L (mm) |  |
| YT-5142     | 210    | 2/12  |

GB Water pump pliers  
D Wasserpumpenzange  
PL Szczypce nastawne  
RUS Ключи переставные  
CZ Keleště siko  
H Vízpumpafágó

RO Cleste papagal  
F Pince réglable  
I Pinze regolabili  
E Alicates de fontanero ajustables  
CN 水泵钳

250 mm 300 mm CrV



| YATO    | L (mm) |      |
|---------|--------|------|
| YT-2090 | 250    | 6/36 |
| YT-2091 | 300    | 6/36 |

GB Water pump pliers  
D Wasserpumpenzange  
PL Szczypce nastawne  
RUS Ключи переставные  
CZ Keleště siko  
H Vízpumpafágó

RO Cleste papagal  
F Pince réglable  
I Pinze regolabili  
E Alicates de fontanero ajustables  
CN 水泵钳

250 mm JAW WIDTH SZEROKOSC SZCZEK 6 mm CrV

WORKING RANGE ADJUSTMENT REGULACJA ZAKRESU PRACY STRENGTHENED JAWS WZMOCNIONA KONSTRUKCJA



| YATO     | L (mm) |       |
|----------|--------|-------|
| YT-20911 | 250    | 10/50 |

GB Pipe wrench  
D Rohrschlüssel  
PL Klucz do rur  
RUS Ключ трубный

CZ Klíč součásti na trubky  
H Csőkulcs  
RO Cheie reglabila pt. tevi

F Clé aux tubes  
I Chiave per tubi  
E Llave para tubos  
CN 铝合金管钳

CrMo

HRC 55-60

AL HANDLE



| YATO    | size / rozmiar | max. pipe diameter / max. średnica rury |      |
|---------|----------------|---|------|
| YT-2482 | 14" (350 mm)   | 2" (50 mm)                              | 6/12 |
| YT-2483 | 18" (450 mm)   | 2.5" (63 mm)                            | 2/10 |
| YT-2484 | 24" (600 mm)   | 3" (75 mm)                              | 2/6  |
| YT-2485 | 36" (900 mm)   | 5" (125 mm)                             | 3    |

GB Pipe wrench  
D Rohrschlüssel  
PL Klucz do rur

RUS Ключ трубный  
CZ Klíč součásti na trubky

H Csőkulcs  
RO Cheie reglabila pt. tevi  
F Clé serre-tube

I Chiave per tubi  
E Llave para tubos  
CN 铝合金管钳

HRC 55-60

OFFSET TYPE



GB Water pump pliers  
D Wasserpumpenzange  
PL Szczypce nastawne  
RUS Ключи переставные  
CZ Keleště siko  
H Vízpumpafágó

RO Cleste papagal  
F Pince réglable  
I Pinze regolabili  
E Alicates de fontanero ajustables  
CN 水泵钳

HALF DOUBLE BLISTER



250 mm

NICKEL IRON FINISH

| YATO    | L (mm) |      |
|---------|--------|------|
| YT-2069 | 250    | 6/36 |



| YATO    | L (mm) |      |
|---------|--------|------|
| YT-2070 | 250    | 6/24 |

GB Pipe wrench  
D Rohrschlüssel  
PL Klucz do rur  
RUS Ключ трубный

CZ Klíč součásti na trubky  
H Csőkulcs  
RO Cheie reglabila pt. tevi

F Clé aux tubes  
I Chiave per tubi  
E Llave para tubos  
CN 铝合金管钳

CrMo

HRC 55-60



| YATO    | size / rozmiar | max. pipe diameter / max. średnica rury |      |
|---------|----------------|---|------|
| YT-2488 | 10" (250 mm)   | 1" (25 mm)                              | 6/18 |
| YT-2489 | 12" (300 mm)   | 1.5" (38 mm)                            | 6/12 |
| YT-2490 | 14" (350 mm)   | 2" (50 mm)                              | 2/10 |
| YT-2491 | 18" (450 mm)   | 2.5" (63 mm)                            | 3/6  |
| YT-2492 | 24" (600 mm)   | 3" (75 mm)                              | 2/4  |
| YT-2493 | 36" (900 mm)   | 5" (125 mm)                             | 1    |
| YT-2494 | 48" (1200 mm)  | 6" (150 mm)                             | 1    |

GB Pipe wrench  
D Rohrschlüssel  
PL Klucz do rur  
RUS Ключ трубный

CZ Klíč součásti na trubky  
H Csőkulcs  
RO Cheie reglabila pt. tevi

F Clé aux tubes  
I Chiave per tubi  
E Llave para tubos  
CN 铝合金管钳

HRC 55-60

AL HANDLE



| YATO    | size / rozmiar | max. pipe diameter / max. średnica rury |      |
|---------|----------------|---|------|
| YT-2222 | 12" (300 mm)   | 1" (25 mm)                              | 6/24 |
| YT-2223 | 14" (350 mm)   | 1.5" (38 mm)                            | 4/16 |
| YT-2224 | 18" (450 mm)   | 2" (50 mm)                              | 3/12 |
| YT-2225 | 24" (600 mm)   | 2.5" (63 mm)                            | 3/6  |

GB Chain pipe wrench  
D Kettenrohrzange  
PL Klucz łańcuchowy do rur  
RUS Ключ цепной для труб  
CZ Klíč řetězový na trubky  
H Láncos csőfógó

RO Cheie reglabila pt. tevi cu lant  
F Clé à chaîne  
I Chiave a catena per tubi  
E Llave de cadena  
CN 链条管子钳

SLIDING CARD



4" 100 mm

300 mm

INDUCTION HARDENED TEETH ZĘBY HARTOWANE INDUKCYJNIE ADJUSTABLE WORKING RANGE REGULOWANY ZAKRES PRACY



| YATO     | L (mm) | max. pipe diameter / max. średnica rury |      |
|----------|--------|---|------|
| YT-22260 | 300    | 4" (100 mm)                             | 6/24 |

















# 7

## Electrician tools Narzędzia dla elektryków





|   |  |
|---|--|
| <b>Insulated screwdrivers</b><br><b>Wkrętaki izolowane</b><br><br>..... 138    | <b>Electrical cutters</b><br><b>Obcinaki elektryczne</b><br><br>..... 146   |
| <b>Insulated slotted screwdrivers</b><br>Wkrętaki izolowane płaskie..... 138<br><b>Insulated phillips screwdrivers</b><br>Wkrętaki izolowane krzyżakowe..... 138<br><b>Insulated Pozidrive screwdrivers</b><br>Wkrętaki izolowane „Pozidrive”..... 138<br><b>Insulated screwdriver sets</b><br>Komplet y wkrętałów izolowanych..... 138     | <b>Cable cutters</b><br><b>Nożyce do kabli</b><br><br>..... 146-147   |
| <b>Insulated pliers</b><br><b>Szczypce izolowane</b><br><br>..... 139    | <b>Electric meters &amp; voltage testers</b><br><b>Mierniki elektryczne i próbniki napięcia</b><br><br>..... 148  |
| <b>Combination pliers</b><br>Szczypce uniwersalne..... 139<br><b>Side cutting pliers</b><br>Szczypce tnące, boczne..... 139<br><b>Long nose pliers</b><br>Szczypce wydłużone, proste..... 139<br><b>Bent nose pliers</b><br>Szczypce wydłużone, wygięte..... 139<br><b>Wire stripping pliers</b><br>Szczypce do ściągania izolacji..... 139 | <b>Multimeters</b><br><b>Mierniki</b><br><br>..... 149    |
| <b>Crimping pliers &amp; sets</b><br><b>Szczypce do zaciskania konektorów i zestawy</b><br><br>..... 140-142    | <b>Glue guns</b><br><b>Pistolety do klejenia</b><br><br>..... 150   |
| <b>Hydraulic pliers</b><br><b>Ręczne praski hydrauliczne</b><br><br>..... 143    | <b>Soldering tools &amp; accessories</b><br><b>Lutownice i akcesoria</b><br><br>..... 150-151                     |
| <b>Wire strippers</b><br><b>Ściągacze izolacji</b><br><br>..... 143-145    | <b>Tweezers</b><br><b>Pęsety</b><br><br>..... 151   |
|   | <b>Electrical insulation tapes &amp; sets</b><br><b>Taśmy elektroizolacyjne i zestawy</b><br><br>..... 152      |

GB Insulated screwdriver  
 D Isolierte Schraubendreher  
 PL Wkrętak izolowany  
 RUS Изолированная отвёртка  
 CZ Izolovaný šroubovák  
 H Szigetelt csavarhúzó

RO Şurubelniţă izolată  
 F Tournevis isolé  
 I Cacciavite isolato  
 E Destornillador aislado  
 CN 绝缘螺丝批

PLASTIC HANGER



1000 V S2 HRC 56-60



⊖ • application: industry • przeznaczenie: przemysł  
 • VDE certificate • certyfikat VDE

| YATO    | ⊖   | L (mm) |        |
|---------|-----|--------|--------|
| YT-2815 | 3.0 | 75     | 12/120 |
| YT-2816 | 4.0 | 75     | 12/120 |
| YT-2817 | 4.0 | 100    | 12/120 |

| YATO    | ⊖   | L (mm) |        |
|---------|-----|--------|--------|
| YT-2818 | 5.5 | 125    | 12/120 |
| YT-2819 | 6.5 | 150    | 12/120 |
| YT-2820 | 8.0 | 175    | 12/120 |

7



⊕ • application: industry • przeznaczenie: przemysł  
 • VDE certificate • certyfikat VDE

| YATO    | ⊕   | L (mm) |        |
|---------|-----|--------|--------|
| YT-2821 | PH0 | 60     | 12/120 |
| YT-2822 | PH1 | 80     | 12/120 |

| YATO    | ⊕   | L (mm) |        |
|---------|-----|--------|--------|
| YT-2823 | PH2 | 100    | 12/120 |
| YT-2824 | PH3 | 150    | 12/120 |



⊕ • application: industry • przeznaczenie: przemysł  
 • VDE certificate • certyfikat VDE

| YATO    | ⊕   | L (mm) |        |
|---------|-----|--------|--------|
| YT-2825 | PZ1 | 80     | 12/120 |

| YATO    | ⊕   | L (mm) |        |
|---------|-----|--------|--------|
| YT-2826 | PZ2 | 100    | 12/120 |

GB Insulated screwdriver set  
 D Isolierte Schraubendrehersatz  
 PL Komplet wkrętaków izolowanych  
 RUS Изолированная отвёртка - набор  
 CZ Izolované šroubováky  
 H Szigetelt csavarhúzó

RO Şurubelniţă izolată  
 F Set de tournevis isolés  
 I Set di cacciavite isolato  
 E Juego de destornilladores aislado  
 CN 绝缘螺丝批组套

DOUBLE BLISTER



1000 V S2 HRC 56-60



5 PCS



• application: industry • przeznaczenie: przemysł  
 • VDE certificate • certyfikat VDE

| YATO    | ⊖   | ⊕   | L (mm) |       |
|---------|-----|-----|--------|-------|
| YT-2827 | 3.0 |     | 75     | 20/40 |
|         | 4.0 |     | 100    |       |
|         | 5.5 |     | 125    |       |
|         |     | PH1 | 80     |       |
|         |     | PH2 | 100    |       |



7 PCS



• application: industry • przeznaczenie: przemysł  
 • VDE certificate • certyfikat VDE

| YATO    | ⊖   | ⊕   | ⊕   | L (mm) |       |
|---------|-----|-----|-----|--------|-------|
| YT-2828 | 3.0 |     |     | 75     | 20/40 |
|         | 4.0 |     |     | 100    |       |
|         | 5.5 |     |     | 125    |       |
|         |     | PH1 |     | 80     |       |
|         |     | PH2 |     | 100    |       |
|         |     |     | PZ1 | 80     |       |
|         |     |     | PZ2 | 100    |       |



GB Combination pliers  
D Kombinationszange  
PL Szczypce uniwersalne  
RUS Плоскогубцы универсальные  
CZ Kleště kombinované  
H Kombináltfogó  
RO Patent universal  
F Pince universelle  
I Pinze universali  
E Alicates universales  
CN 钢丝钳

160 mm 180 mm 200 mm 1000 V DIN 5746 CrV



05 VDE  
CERTIFICATE  
-IEC60900:2004

HALF  
DOUBLE  
BLISTER

| YATO    | L (mm) |      |
|---------|--------|------|
| YT-2101 | 160    | 6/60 |
| YT-2102 | 180    | 6/60 |
| YT-2103 | 200    | 6/60 |

GB Diagonal side cutting pliers  
D Seitenschneider  
PL Szczypce tnące boczne  
RUS Бокорезы  
CZ Řezací kleště boční  
H Oldal csípőfogó  
RO Olește tăietor  
F Pince à coupe latérale  
I Pinze taglienti laterali  
E Alicates corte lateral  
CN 斜嘴钳

160 mm 1000 V DIN 5749 CrV



05 VDE  
CERTIFICATE  
-EN60900:2004

HALF  
DOUBLE  
BLISTER

| YATO    | L (mm) |      |
|---------|--------|------|
| YT-2109 | 160    | 6/60 |

GB Diagonal side cutting pliers  
D Seitenschneider  
PL Szczypce tnące boczne  
RUS Бокорезы  
CZ Řezací kleště boční  
H Oldal csípőfogó  
RO Olește tăietor  
F Pince à coupe latérale  
I Pinze taglienti laterali  
E Alicates corte lateral  
CN 斜嘴钳

180 mm 1000 V DIN 5749 CrV



05 VDE  
CERTIFICATE  
-EN60900:2004

HALF  
DOUBLE  
BLISTER

| YATO    | L (mm) |      |
|---------|--------|------|
| YT-2110 | 180    | 6/60 |

GB Long nose pliers  
D Radiozange  
PL Szczypce wydłużone proste  
RUS Тонкогубцы прямые  
CZ Prodloužené kleště rovné  
H Rádiófogó, egyenes  
RO Clește cu vârf ascuțit  
F Pince prolongée  
I Pinze lunghe diritte  
E Alicates de punta  
CN 尖嘴钳

160 mm 200 mm 1000 V DIN 5745 CrV



05 VDE  
CERTIFICATE  
-EN60900:2004

HALF  
DOUBLE  
BLISTER

| YATO    | L (mm) |      |
|---------|--------|------|
| YT-2104 | 160    | 6/60 |
| YT-2105 | 200    | 6/60 |

GB Bent nose pliers  
D Telefonzange  
PL Szczypce wydłużone wygięte  
RUS Тонкогубцы изогнутые  
CZ Prodloužené kleště ohnuté  
H Rádió - és telefonfogó, hajlított  
RO Clește cu vârf ascuțit îndoit  
F Pince prolongée cambree  
I Pinze a punta mezzo tonde  
E Alicates de punta curvos  
CN 弯嘴钳

200 mm 1000 V DIN 5745 CrV



05 VDE  
CERTIFICATE  
-EN60900:2004

HALF  
DOUBLE  
BLISTER

| YATO    | L (mm) |      |
|---------|--------|------|
| YT-2107 | 200    | 6/60 |

GB Wire stripping pliers  
D Abisolierzange  
PL Szczypce do ściągania izolacji  
RUS Пасатижи для зачистки проводов  
CZ Kleště odizolovací na drát  
H Blankoló fogó  
RO Decablator  
F Pince à l'isolation  
I Pinze spelafili  
E Pinzas pelacables  
CN 剥线钳

160 mm 1000 V DIN 5745 CrV



05 VDE  
CERTIFICATE  
-EN60900:2004

HALF  
DOUBLE  
BLISTER

| YATO    | L (mm) |      |
|---------|--------|------|
| YT-2112 | 160    | 6/60 |

- GB Quick interchangeable ratchet crimper set
- D Kabelschuhzange
- PL Zestaw do zaciskania konektorów
- RUS Инструмент для обжима и зачистки проводов
- CZ Kleště pro svěráni zaciskania konektorů
- H Krimpelő fogó
- RO Clește sertizat conectori
- F Pince à sertir pour connecteurs
- I Set pinze i compare a connettori
- E Pinzas de apretar de conectores
- CN 棘轮压线钳组套

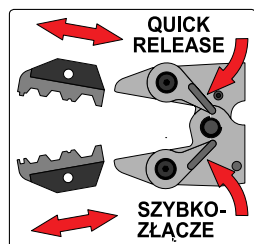
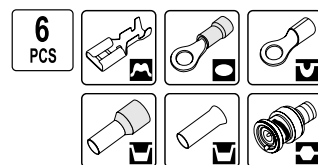

BMC & COLOR SLEEVE



| YATO    | mm <sup>2</sup> | AWG   | mm <sup>2</sup> | AWG   | mm <sup>2</sup> | AWG  | mm <sup>2</sup> | AWG   |                       |    |
|---------|-----------------|-------|-----------------|-------|-----------------|------|-----------------|-------|-----------------------|----|
| YT-2245 | 0.5-6.0         | 20-10 | 0.5-6.0         | 22-10 | 1.5-10.0        | 20-8 | 0.5-4.0         | 22-12 | RG6, RG58, RG59, RG62 | 10 |

7

- GB Ratchet crimping pliers
- D Kabelschuhzange
- PL Szczypce do zaciskania konektorów
- RUS Инструмент для обжима и зачистки проводов

- CZ Kleště pro svěráni zaciskania konektorů
- H Krimpelő fogó
- RO Clește sertizat conectori
- F Pince pour serrer les connecteurs

- I Pinze i compare a connettori
- E Pinzas de apretar de conectores
- CN 棘轮压线钳

SLIDING CARD



| YATO    | mm <sup>2</sup> | AWG   |      |
|---------|-----------------|-------|------|
| YT-2250 | 0.5-6.0         | 20-10 | 5/30 |

| YATO    | mm <sup>2</sup> | AWG   |      |
|---------|-----------------|-------|------|
| YT-2300 | 0.5-6.0         | 20-10 | 5/30 |

- GB Ratchet crimping pliers
- D Kabelschuhzange
- PL Szczypce do zaciskania konektorów
- RUS Инструмент для обжима и зачистки проводов

- CZ Kleště pro svěráni zaciskania konektorů
- H Krimpelő fogó
- RO Clește sertizat conectori
- F Pince pour serrer les connecteurs

- I Pinze i compare a connettori
- E Pinzas de apretar de conectores
- CN 棘轮压线钳

BLISTER CARD



| YATO    | mm <sup>2</sup> | AWG   | mm <sup>2</sup> | AWG   |       |
|---------|-----------------|-------|-----------------|-------|-------|
| YT-2255 | 0.08-2.0        | 28-14 | 0.12-0.3        | 26-22 | 10/60 |

| YATO    | mm <sup>2</sup> | AWG   | mm <sup>2</sup> | AWG   | mm <sup>2</sup> | AWG   |       |
|---------|-----------------|-------|-----------------|-------|-----------------|-------|-------|
| YT-2256 | 0.08-2.0        | 28-14 | 0.3-6.0         | 22-10 | 0.12-0.3        | 26-22 | 10/60 |

- GB Ratchet crimping pliers
- D Kabelschuhzange
- PL Szczypce do zaciskania konektorów
- RUS Инструмент для обжима и зачистки проводов

- CZ Kleště pro svěráni zaciskania konektorů
- H Krimpelő fogó
- RO Clește sertizat conectori
- F Pince pour serrer les connecteurs

- I Pinze i compare a connettori
- E Pinzas de apretar de conectores
- CN 棘轮压线钳

SLIDING CARD



| YATO    | mm <sup>2</sup> | AWG   |      |
|---------|-----------------|-------|------|
| YT-2296 | 0.5-6.0         | 22-10 | 5/30 |

| YATO    | mm <sup>2</sup> | AWG   |      |
|---------|-----------------|-------|------|
| YT-2246 | 0.5-6.0         | 22-10 | 5/30 |





GB Ratchet crimping pliers  
D Kabelschuhzange  
PL Szczypce do zaciskania konektorów  
RUS Инструмент для обжима  
и зачистки проводов

CZ Kleště pro svěráni zaciskania konektorů  
H Krimpelő fogó  
RO Clește sertizat conectori  
F Pince pour serrer les connecteurs



I Pinze i compare a conettori  
E Pinzas de apretar de conectores  
CN 棘轮压线钳

SLIDING  
CARD





|   |   |       |   |
|---|---|-------|---|
| <b>YATO</b>  |  |       |  |
|   | mm <sup>2</sup>   | AWG   |   |
| YT-2251   | 0.5-6.0   | 22-10 | 5/30  |





|   |   |       |   |
|---|---|-------|---|
| <b>YATO</b>  |  |       |  |
|   | mm <sup>2</sup>   | AWG   |   |
| YT-2302   | 0.5-6.0   | 22-10 | 5/30  |





|   |   |       |   |
|---|---|-------|---|
| <b>YATO</b>  |  |       |  |
|   | mm <sup>2</sup>   | AWG   |   |
| YT-2283   | 0.5-2.5   | 22-14 | 6/36  |





|   |   |       |   |
|---|---|-------|---|
| <b>YATO</b>  |  |       |  |
|   | mm <sup>2</sup>   | AWG   |   |
| YT-2307   | 0.5-2.5   | 22-14 | 6/36  |





|   |   |      |   |
|---|---|------|---|
| <b>YATO</b>  |  |      |  |
|   | mm <sup>2</sup>   | AWG  |   |
| YT-2297   | 1.5-10.0  | 20-8 | 5/30  |





|   |   |      |   |
|---|---|------|---|
| <b>YATO</b>  |  |      |  |
|   | mm <sup>2</sup>   | AWG  |   |
| YT-2247   | 1.5-10.0  | 20-8 | 5/30  |



|   |   |      |   |
|---|---|------|---|
| <b>YATO</b>  |  |      |  |
|   | mm <sup>2</sup>   | AWG  |   |
| YT-2301   | 0.5-10.0  | 22-8 | 6/36  |



|   |   |     |   |
|---|---|-----|---|
| <b>YATO</b>  |  |     |  |
|   | mm <sup>2</sup>   | AWG |   |
| YT-2298   | RG6, RG58, RG59, RG62   |     | 5/30  |



|   |   |       |   |
|---|---|-------|---|
| <b>YATO</b>  |  |       |  |
|   | mm <sup>2</sup>   | AWG   |   |
| YT-2299   | 0.5-4.0   | 22-12 | 5/30  |



|   |   |       |   |
|---|---|-------|---|
| <b>YATO</b>  |  |       |  |
|   | mm <sup>2</sup>   | AWG   |   |
| YT-2249   | 0.5-4.0   | 22-12 | 5/30  |

GB Ratchet crimping pliers  
 D Kabelschuhzange  
 PL Szczypce do zaciskania konektorów  
 RUS Инструмент для обжима  
 и зачистки проводов

CZ Kleště pro svěráni zaciskania konektorů  
 H Krimpelő fogó  
 RO Clește sertizat conectori  
 F Pince pour serrer les connecteurs



I Pinze i compare a connettori  
 E Pinzas de apretar de conectores  
 CN 棘轮压线钳

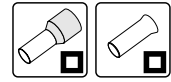

SLIDING  
CARD



HRC  
44-47



|   |   |   |
|---|---|---|
| <b>YATO</b>  |  mm² |  |
| YT-2240   | 0.2-6.0   | 6/36  |

|   |   |   |
|---|---|---|
| <b>YATO</b>  |  mm² |  |
| YT-2305   | 0.2-6.0   | 6/36  |

GB Crimping pliers  
 D Kabelschuhzange  
 PL Szczypce do zaciskania konektorów  
 RUS Инструмент для обжима  
 и зачистки проводов  
 CZ Kleště pro svěráni zaciskania konektorů

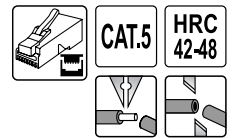

H Krimpelő fogó  
 RO Clește sertizat conectori  
 F Pince pour serrer les connecteurs  
 I Pinze i compare a connettori  
 E Pinzas de apretar de conectores  
 CN 棘轮压线钳

SLIDING  
CARD



CAT.5  
HRC  
42-48



|   |   |   |
|---|---|---|
| <b>YATO</b>  |  |  |
| YT-2242   | RJ45  | 10/60   |



SK5

|   |   |   |
|---|---|---|
| <b>YATO</b>  |  |  |
| YT-2243   | RJ45, RJ11  | 8/48  |



SK5

|   |   |   |
|---|---|---|
| <b>YATO</b>  |  |  |
| YT-22422  | RJ45, RJ11, RJ12  | 10/60   |



SK5

|   |   |   |
|---|---|---|
| <b>YATO</b>  |  |  |
| YT-2244   | RJ45, RJ11, RJ12, RJ22  | 10/60   |



- GB Hydraulic pliers
- D Manuelle Hydraulikpresse
- PL Ręczna praska hydrauliczna
- RUS Ручной гидравлический обжимной инструмент
- CZ Ruční hydraulický lis
- H Kézi hidraulikus prés
- RO Presă hidraulică manuală
- F Pince à sertir
- I Pressa idraulica manuale
- E Prensa hidráulica manual
- CN 液压钳



BMC & COLOR SLEEVE



| YATO     | crimping size range / zakres zaciskania (mm <sup>2</sup> ) |                | L (mm) | pressure / nacisk (T) | crimping jaws size / rozmiar szczęk zaciskających (mm <sup>2</sup> ) | Image |
|----------|--|----------------|--------|-----------------------|--|-------|
|          | aluminium  | copper / miedź |        |                       |  |       |
| YT-22860 | 10-95  | 10-120         | 415    | 8                     | 10; 16; 25; 35; 50; 70; 95; 120                                      | 4     |
| YT-22861 | 16-185   | 16-240         | 470    | 12                    | 16; 25; 35; 50; 70; 95; 120; 150; 185; 240                           | 3     |
| YT-22862 | 16-240   | 16-300         | 470    | 18-20                 | 16; 25; 35; 50; 70; 95; 120; 150; 185; 240; 300                      | 3     |

- GB Crimping pliers
- D Kabelschuhzange
- PL Szczypce do zaciskania konektorów
- RUS Инструмент для обжима и зачистки проводов
- CZ Kleště pro svěření zaciskania konektorů
- H Krimpelő fogó
- RO Clește sertizat conectori
- F Pince pour serrer les connecteurs
- I Pinze i compare a connettori
- E Pinzas de apretar de conectores
- CN 棘轮压线钳

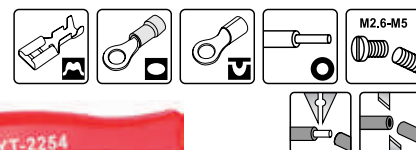

SLIDING CARD

| YATO    | Image           |       | Image           |       | Image           |       | Image           |       | Image |
|---------|-----------------|-------|-----------------|-------|-----------------|-------|-----------------|-------|-------|
|         | mm <sup>2</sup> | AWG   | mm <sup>2</sup> | AWG   | mm <sup>2</sup> | AWG   | mm <sup>2</sup> | AWG   |       |
| YT-2254 | 0.5-5.0         | 20-10 | 0.5-5.0         | 20-10 | 0.5-5.5         | 20-10 | 0.5-5.0         | 20-10 | 12/48 |

- GB Crimping pliers
- D Kabelschuhzange
- PL Szczypce do zaciskania konektorów
- RUS Инструмент для обжима и зачистки проводов
- CZ Kleště pro svěření zaciskania konektorů
- H Krimpelő fogó
- RO Clește sertizat conectori
- F Pince pour serrer les connecteurs

- I Pinze i compare a connettori
- E Pinzas de apretar de conectores
- CN 棘轮压线钳



SLIDING CARD



| YATO    | Image           |       | Image  |
|---------|-----------------|-------|--------|
|         | mm <sup>2</sup> | AWG   |        |
| YT-2271 | 0.5-6.0         | 22-10 | 20/120 |

- GB Wire stripper
- D Abisolierzange
- PL Ściągacz izolacji
- RUS Съёмник изоляции
- CZ Odizolovací klejste
- H Blankolo fogo

- RO Decablator
- F Extracteur d'isolation
- I Pinze per scariare isolamento
- E Extractor de aislado
- CN 万用剥线钳



SLIDING CARD



| YATO    | Image           |       | Image |
|---------|-----------------|-------|-------|
|         | mm <sup>2</sup> | AWG   |       |
| YT-2266 | 0.25-1.3        | 30-16 | 10/60 |

| YATO    | Image           |       | Image |
|---------|-----------------|-------|-------|
|         | mm <sup>2</sup> | AWG   |       |
| YT-2267 | 0.8-2.6         | 20-10 | 10/60 |

- GB Wire stripper
- D Abisolierzange
- PL Ściągacz izolacji
- RUS Съёмник изоляции
- CZ Odizolovací klejste
- H Blankolo fogo
- RO Decablator
- F Extracteur d'isolation

- I Pinze per scariare isolamento
- E Extractor de aislado
- CN 万用剥线钳



SLIDING CARD

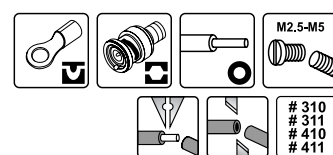

# 310  
# 311  
# 410  
# 411

| YATO    | Image           |       | Image | Image           |      | Image |
|---------|-----------------|-------|-------|-----------------|------|-------|
|         | mm <sup>2</sup> | AWG   |       | mm <sup>2</sup> | AWG  |       |
| YT-2277 | 0.5-6.0         | 22-10 | RG6   | 0.5-6.0         | 20-8 | 10/60 |



GB Wire stripper  
 D Abisolierzange  
 PL Ściągacz izolacji  
 RUS Съёмник изоляции  
 CZ Odizolovací kleje

H Blankolo fogo  
 RO Decablator  
 F Extracteur d'isolation

I Pinze per scaricare isolamento  
 E Extractor de aislado  
 CN 万用剥线钳

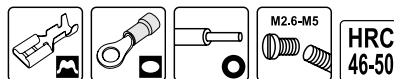
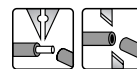

| YATO    | mm <sup>2</sup> | AWG   | RG6 | mm <sup>2</sup> | AWG   | PCS packing |    |
|---------|-----------------|-------|-----|-----------------|-------|-------------|----|
| YT-2292 | 0.5-6.0         | 22-10 |     | 0.64-2.6        | 22-10 | 12          | 72 |

| YATO     | mm <sup>2</sup> | AWG   | mm <sup>2</sup> | AWG   | mm <sup>2</sup> | AWG   |       |
|----------|-----------------|-------|-----------------|-------|-----------------|-------|-------|
| YT-22930 | 1.5-6.0         | 22-10 | 1.5-6.0         | 22-10 | 0.75-6.0        | 22-10 | 12/48 |

7

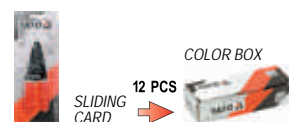
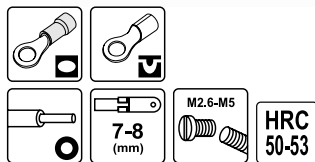

| YATO    | mm <sup>2</sup> | AWG  | mm <sup>2</sup> | AWG | PCS packing |    |
|---------|-----------------|------|-----------------|-----|-------------|----|
| YT-2293 | 1.25-2.5        | 8-12 | 1.0             | 8   | 12          | 72 |

| YATO    | mm <sup>2</sup> | AWG   | PCS packing |     |
|---------|-----------------|-------|-------------|-----|
| YT-2294 | 0.64-2.6        | 22-10 | 12          | 120 |

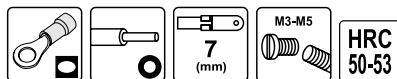

| YATO    | mm <sup>2</sup> | AWG   | mm <sup>2</sup> | AWG   | PCS packing |    |
|---------|-----------------|-------|-----------------|-------|-------------|----|
| YT-2295 | 0.5-6.0         | 22-10 | 0.8-2.6         | 20-10 | 12          | 72 |

| YATO    | mm <sup>2</sup> | AWG   |       |
|---------|-----------------|-------|-------|
| YT-2319 | 0.8-2.6         | 20-10 | 10/60 |

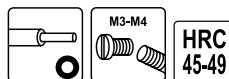
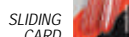

| YATO    | mm <sup>2</sup> | AWG   |        |
|---------|-----------------|-------|--------|
| YT-2272 | 0.34-6.0        | 22-10 | 20/120 |

| YATO    | mm <sup>2</sup> | AWG   |       |
|---------|-----------------|-------|-------|
| YT-2273 | 0.8-2.6         | 20-10 | 10/60 |

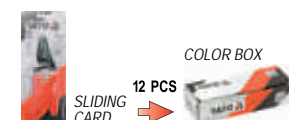
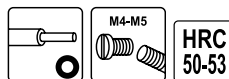

| YATO    | mm <sup>2</sup> | AWG   | PCS packing |     |
|---------|-----------------|-------|-------------|-----|
| YT-2290 | 0.64-2.6        | 22-10 | 12          | 120 |



- GB Universal wire stripper & ratchet crimping pliers  
D Multifunktion Abisolierzange & Kabelschuhklemmzange  
PL Uniwersalny ściągacz izolacji i szczypce do zaciskania konektorów  
RUS Инструмент для снятия изоляции и зажима проводов  
CZ Univerzální odizolovací klejště & kleště pro svěrání zaciskání konektorů  
H Blankolo fogo & krimpelő fogó  
RO Decablator universal & clește sertizat conectori  
F Extracteur d'isolation multifonction  
I Pinze per scaricare isolamento  
E Extractor de aislado multifunción  
CN 万用剥线钳

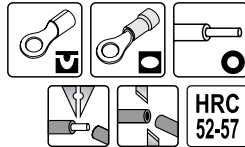

7-8  
(mm)

HALF  
DOUBLE  
BLISTER

| YATO    | □               |       | □               |       | ○               |       | 📦    |
|---------|-----------------|-------|-----------------|-------|-----------------|-------|------|
|         | mm <sup>2</sup> | AWG   | mm <sup>2</sup> | AWG   | mm <sup>2</sup> | AWG   |      |
| YT-2270 | 0.5-6.0         | 22-10 | 1.5-6.0         | 22-10 | 0.2-6.0         | 24-10 | 5/30 |



SLIDING  
CARD

| YATO    | □               |       | □               |       | ○               |       | 📦    |
|---------|-----------------|-------|-----------------|-------|-----------------|-------|------|
|         | mm <sup>2</sup> | AWG   | mm <sup>2</sup> | AWG   | mm <sup>2</sup> | AWG   |      |
| YT-2313 | 0.5-6.0         | 22-10 | 1.5-6.0         | 22-10 | 0.2-6.0         | 24-10 | 5/30 |

- GB Universal wire stripper & ratchet crimping pliers  
D Multifunktion Abisolierzange & Kabelschuhklemmzange  
PL Uniwersalny ściągacz izolacji i szczypce do zaciskania konektorów  
RUS Инструмент для снятия изоляции и зажима проводов  
CZ Univerzální odizolovací klejště & kleště pro svěrání zaciskání konektorů  
H Blankolo fogo & krimpelő fogó  
RO Decablator universal & clește sertizat conectori  
F Extracteur d'isolation multifonction  
I Pinze per scaricare isolamento  
E Extractor de aislado multifunción  
CN 剥线钳

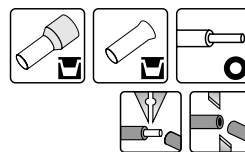

SLIDING  
CARD

| YATO    | □               |       | ○               |       | 📦     |
|---------|-----------------|-------|-----------------|-------|-------|
|         | mm <sup>2</sup> | AWG   | mm <sup>2</sup> | AWG   |       |
| YT-2278 | 0.5-6.0         | 22-10 | 0.2-6.0         | 24-10 | 10/60 |

- GB Automatic wire stripper  
D Automatische Abisolierzange  
PL Automatyczny ściągacz izolacji  
RUS Клещи для удаления изоляции  
CZ Automatický stahovač izolace  
H Automatikus szigeteléselhúzó  
RO Clește automat pt. desizolat
- F Extracteur d'isolation automatique  
I Pinze per scaricare isolamento  
E Pelacables automatico  
CN 万用剥线钳

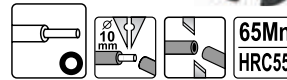

| YATO    | 📦     |
|---------|-------|
| YT-2268 | 10/60 |

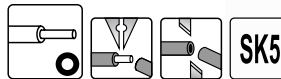

| YATO    | ○               |       | 📦     |
|---------|-----------------|-------|-------|
|         | mm <sup>2</sup> | AWG   |       |
| YT-2275 | 0.5-6.0         | 20-10 | 10/60 |

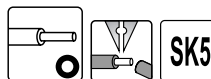

| YATO    | ○               |       | 📦    |
|---------|-----------------|-------|------|
|         | mm <sup>2</sup> | AWG   |      |
| YT-2276 | 1.0-3.2         | 18-12 | 8/48 |

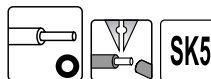

| YATO    | ○               |       | 📦    |
|---------|-----------------|-------|------|
|         | mm <sup>2</sup> | AWG   |      |
| YT-2316 | 1.0-3.2         | 18-12 | 8/48 |

- GB Wire stripper  
D Abisolierzange  
PL Ściągacz izolacji  
RUS Съёмник изоляции  
CZ Odizolovací klejště  
H Blankolo fogo
- RO Decablator  
F Extracteur d'isolation  
I Pinze per scaricare isolamento
- E Extractor de aislado  
CN 万用剥线钳

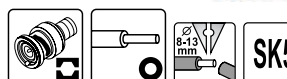

SLIDING  
CARD

| YATO    | □               |     | ○               |       | 📦     |
|---------|-----------------|-----|-----------------|-------|-------|
|         | mm <sup>2</sup> | AWG | mm <sup>2</sup> | AWG   |       |
| YT-2274 | RG9, RG59       |     | 0.5-6.0         | 20-10 | 15/90 |

GB Electrical cutter  
D Seitenschneider  
PL Obcinak elektryczny  
RUS Инструмент для обрезки проводов  
CZ Elektrické upichováky  
H Kábelvágó  
RO Clește tăietor - electrician  
F Coupeur isolé

I Pinza per elettronica  
E Cortacables eléctricos  
CN 电子斜嘴钳

125 mm

SLIDING CARD

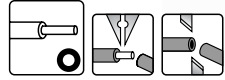

| YATO    | mm <sup>2</sup> | AWG   | L (mm) |        |
|---------|-----------------|-------|--------|--------|
| YT-2260 | 0.5-1.5         | 20-18 | 125    | 15/150 |



| YATO    | L (mm) |        |
|---------|--------|--------|
| YT-2261 | 125    | 15/150 |

GB Electrical cutter  
D Seitenschneider  
PL Obcinak elektryczny  
RUS Инструмент для обрезки проводов  
CZ Elektrické upichováky  
H Kábelvágó  
RO Clește tăietor - electrician  
F Coupeur isolé

I Pinza per elettronica  
E Cortacables eléctricos  
CN 电子斜嘴钳

125 mm

3.0 (mm) (max)

STAINLESS STEEL STAL NERDZEWA



SLIDING CARD



| YATO    | L (mm) |        |
|---------|--------|--------|
| YT-2262 | 125    | 20/120 |

7

GB Electrical cutter  
D Seitenschneider  
PL Obcinak elektryczny  
RUS Инструмент для обрезки проводов  
CZ Elektrické upichováky  
H Kábelvágó

RO Clește tăietor - electrician  
F Coupeur isolé  
I Pinza per elettronica  
E Cortacables eléctricos  
CN 电子斜嘴钳

130 mm



HRC 55-57

65 Mn



SLIDING CARD



| YATO    | L (mm) |        |
|---------|--------|--------|
| YT-2263 | 130    | 12/120 |

GB Cable cutter  
D Kabelschere  
PL Szczypce do cięcia przewodów  
RUS Кабелерезы  
CZ Elektrické upichováky  
H Kábelvágó  
RO Patent tăietor pt. electrice

F Pince pour câbles  
I Cesoia per cavi elettrici  
E Tijeras para cables  
CN 电缆断线钳

170 mm

3.5 mm

10.5 mm (max)

SK5



SLIDING CARD



| YATO    | L (mm) |       |
|---------|--------|-------|
| YT-2279 | 170    | 10/60 |

GB Cable stripper  
D Kabelmesser  
PL Nożyk do kabli  
RUS Нож кабельный

CZ Nůž na kabele  
H Kábelkés  
RO Cuțitaș pt. cabluri  
F Couteau aux câbles

I Coltellino per cavi  
E Cuchillo  
CN 电缆剥线钳

8-28 mm



SLIDING CARD



| YATO    | Ø (mm) |        |
|---------|--------|--------|
| YT-2280 | 8-28   | 10/100 |

GB Electrician scissors  
D Elektrische Schere  
PL Nożyczki dla elektryków  
RUS Ножницы универсальные  
CZ Elektrické nůžky  
H Univerzális olló  
RO Foarfece - electrician

F Ciseaux pour electriciens  
I Forbici per elettricisti  
E Tijeras eléctricos  
CN 电工剪

140 mm

STAINLESS STEEL STAL NERDZEWA

HRC 52-56



SLIDING CARD



| YATO    | L (mm) |        |
|---------|--------|--------|
| YT-1974 | 140    | 12/120 |

GB Electrician's knife  
D Montagemesser  
PL Nóż składany monterski  
RUS Нож складной

CZ Montážní nůž  
H Szerelőkés  
RO Cuțit pt. decablat  
F Couteau d'électricien

I Coltello  
E Cuchillo de montaje  
CN 电工刀

SLIDING CARD



3CR13

HRC 42-48

85 mm

200 mm



| YATO    | L (mm) |      |
|---------|--------|------|
| YT-7600 | 200    | 6/96 |

75 mm

190 mm



| YATO    | L (mm) |      |
|---------|--------|------|
| YT-7601 | 190    | 6/96 |



- GB Cable cutter  
D Kabelschere  
PL Szczypce do cięcia przewodów  
RUS Кабелерезы  
CZ Elektrické upichováky  
H Kábelvágó  
RO Patent tăietor pt. electrice  
F Pince à couper les fils  
I Pinze per tagliare i cavi  
E Tijeras para cables  
CN 电缆剪

SLIDING  
CARD



- application: for copper and aluminium electric cables
- przeznaczenie: do cięcia miedzianych i aluminiowych kabli

| YATO    | L (mm) | max. Ø (mm) |      |
|---------|--------|-------------|------|
| YT-1966 | 160    | 6           | 6/60 |
| YT-1967 | 210    | 7           | 6/60 |
| YT-1968 | 240    | 8           | 6/48 |

- GB Heavy duty cable cutter  
D Schwere Drahtschere  
PL Wzmocnione nożyce do cięcia przewodów  
RUS Кабелерезы  
CZ Elektrické upichováky  
H Kábelvágó  
RO Patent tăietor pt. electrice  
F Pince renforcée à couper les fils  
I Pinze per tagliare i cavi  
E Tijeras para cables  
CN 电缆剪

SLIDING  
CARD



- application: for copper and aluminium electric cables
- przeznaczenie: do cięcia miedzianych i aluminiowych kabli

| YATO    | L (mm) | max. Ø (mm) |      |
|---------|--------|-------------|------|
| YT-1969 | 240    | 9           | 6/48 |

- GB Heavy duty cable cutter  
D Schwere Drahtschere  
PL Wzmocnione nożyce do cięcia przewodów  
RUS Кабелерезы  
CZ Elektrické upichováky  
H Kábelvágó  
RO Patent tăietor pt. electrice  
F Pince renforcée à couper les fils  
I Pinze per tagliare i cavi  
E Tijeras para cables  
CN 电缆剪

SLIDING  
CARD

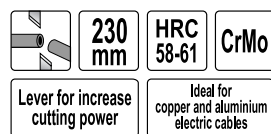

| YATO    | L (mm) | max. Ø (mm) |      |
|---------|--------|-------------|------|
| YT-1933 | 230    | 9           | 6/36 |

- GB Cable cutter  
D Kabelschere  
PL Nożyce do kabli  
RUS Кабелерезы  
CZ Elektrické upichováky  
H Kábelvágó  
RO Patent tăietor pt. electrice  
F Cisailles à câbles  
I Cesioie per cavi  
E Tijeras para cables  
CN 电缆剪



COLOR BOX



STEEL  
STAL

- GB Ratchet cable cutter  
D Ratschenkabelschneider  
PL Nożyce zapadkowe do kabli  
RUS Кабелерез секторный  
CZ Kleště na kabely, rohatka se západkou  
H Racsnis kábelvágó  
RO Cleste pt. taiat cablu cu clichet  
F Cisailles à câbles  
I Cricchetto taglia cavo  
E Cortacables de carraca  
CN 棘轮电缆剪

COLOR BOX



Cu/Al  
CABLE  
KABEL

60Si2Mn

HRC 50  
CUTTING BLADE  
OSTRZE THACE



| YATO     | cutting range /<br>max. przekrój cięcia (mm <sup>2</sup> ) | L (mm) |    |
|----------|--|--------|----|
| YT-18600 | 240  | 300    | 10 |



| YATO     | cutting range /<br>max. przekrój cięcia (mm <sup>2</sup> ) | L (mm) |    |
|----------|--|--------|----|
| YT-18602 | 380  | 380    | 10 |



| YATO     | cutting range /<br>max. przekrój cięcia (mm <sup>2</sup> ) | L (mm) |    |
|----------|--|--------|----|
| YT-18610 | 125  | 370    | 20 |
| YT-18611 | 250  | 580    | 10 |
| YT-18612 | 500  | 770    | 5  |

- |                          |                       |                            |
|--------------------------|-----------------------|----------------------------|
| GB Voltage tester        | H Fáziskereső         | I Cerca fase               |
| D Spannungsprüfer        | RO Creion de tensiune | E Comprobador de corriente |
| PL Próbnik napięcia      | F Testeur de tension  | CN VDE 测电笔                 |
| RUS Отвёртка с передачей | type tournevis        |                            |
| CZ Zkoušeč napětí        |                       |                            |

PLASTIC HANGER



125-250  
V~



|             |   |        |        |
|-------------|---|--------|--------|
| <b>YATO</b> | ⊖ | L (mm) |        |
| YT-2830     | 4 | 190    | 12/144 |

- |                                   |                       |                            |              |
|-----------------------------------|-----------------------|----------------------------|--------------|
| GB Digital voltage tester         | H Fáziskereső         | I Cerca fase               | SLIDING CARD |
| D Spannungsprüfer                 | RO Creion de tensiune | E Comprobador de corriente |              |
| PL Uniwersalny tester elektryczny | F Testeur de tension  | CN 多功能测电笔                  |              |
| RUS Отвёртка с передачей          | type tournevis        |                            |              |
| CZ Zkoušeč napětí                 |                       |                            |              |

SLIDING CARD



1.5-9 V

50-500 Hz

CONTINUITY TEST  
TEST CĂGĂLOȘCI

70-250 V

70-600 V

POWER ZASILANE  
2x1.5 V  
LR41  
BATTERY\*  
\* BATTERY NOT INCLUDED  
\* BATERII NE DOLĂCĂZONO

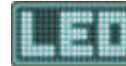

|             |       |
|-------------|-------|
| <b>YATO</b> |       |
| YT-2864     | 6/120 |

7

- |                                   |                       |              |
|-----------------------------------|-----------------------|--------------|
| GB Digital voltage tester         | H Fáziskereső         | SLIDING CARD |
| D Spannungsprüfer                 | RO Creion de tensiune |              |
| PL Uniwersalny tester elektryczny | F Testeur de tension  |              |
| RUS Отвёртка с передачей          | type tournevis        |              |
| CZ Zkoušeč napětí                 |                       |              |
| H Fáziskereső                     |                       |              |
| RO Creion de tensiune             |                       |              |
| F Testeur de tension              |                       |              |
| type tournevis                    |                       |              |
| I Cerca fase digitale             |                       |              |
| E Comprobador de corriente        |                       |              |
| CN 测电笔                            |                       |              |

SLIDING CARD



1.5-9 V

50-500 Hz

70-250 V

70-1000 V

POWER ZASILANE  
2x1.5 V  
LR44  
BATTERY\*  
\* BATTERY NOT INCLUDED  
\* BATERII NE DOLĂCĂZONO

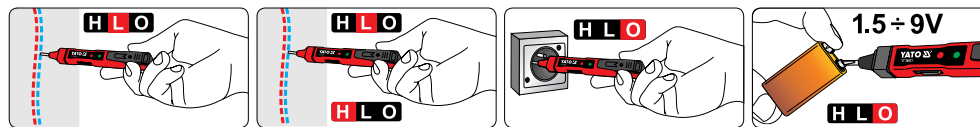

|             |       |
|-------------|-------|
| <b>YATO</b> |       |
| YT-28631    | 6/120 |

- |                                |  |              |
|--------------------------------|--|--------------|
| GB Digital voltage tester      | RO Tester digital pt. tensiune electrica | SLIDING CARD |
| D Digitaler-Spannungsprüfer    | F Testeur de tension                     |              |
| PL Wskaźnik elektryczny        | type tournevis                           |              |
| RUS Тестер напряжения цифровой | I Cerca fase digitale                    |              |
| CZ Zkoušečka napětí digitální  | E Indicador eléctrico                    |              |
| H Digitális voltmérő           | CN 数显测电笔                                 |              |

SLIDING CARD



12-250 V

50-500 Hz

CONTINUITY TEST  
TEST CĂGĂLOȘCI

LCD DISPLAY

NO BATTERY NEEDED  
NE POTRĂBĂRILE BATERII



|             |        |
|-------------|--------|
| <b>YATO</b> |        |
| YT-2861     | 20/500 |



|             |        |
|-------------|--------|
| <b>YATO</b> |        |
| YT-2862     | 20/500 |



|             |       |
|-------------|-------|
| <b>YATO</b> |       |
| YT-2863     | 6/120 |



GB Digital universal multimeter  
D Universell digital Messgerät  
PL Cyfrowy miernik uniwersalny  
RUS Универсальный цифровой измеритель  
CZ Digitální multimetr univerzální  
H Digitális multiméter  
RO Multimetru digital universal  
F Multimètre numérique  
I Universale tester digitale  
E Manómetro digital universal  
CN 数字万用表

|                  |                  |                         |
|------------------|------------------|-------------------------|
| U<br>0-500<br>~V | U<br>0-500<br>~V | I<br>0-5<br>~A          |
| R<br>0-2<br>MΩ   |                  | h <sub>FE</sub> PNP NPN |
|                  |                  |                         |



**YATO**  
YT-73080 50

|                  |                  |                  |                       |                 |                           |
|------------------|------------------|------------------|-----------------------|-----------------|---------------------------|
|                  | U<br>0-600<br>~V | U<br>0-600<br>~V | I<br>0-10<br>~A       | I<br>0-10<br>~A | R<br>0-40<br>MΩ           |
| C<br>0-100<br>μF | f<br>100<br>kHz  |                  | T<br>-20°+<br>+1000°C |                 | AUTO RANGE<br>AUTO ZAKRES |
|                  |                  |                  |                       | AUTO POWER OFF  |                           |



**YATO**  
YT-73086 24

|                   |                  |                 |                         |                 |                 |
|-------------------|------------------|-----------------|-------------------------|-----------------|-----------------|
| U<br>0-1000<br>~V | U<br>0-750<br>~V | I<br>0-10<br>~A | I<br>0-10<br>~A         | R<br>0-20<br>MΩ | C<br>0-20<br>μF |
|                   |                  |                 | h <sub>FE</sub> PNP NPN | AUTO POWER OFF  |                 |



**YATO**  
YT-73082 30

|                  |                  |                           |                       |                 |                    |
|------------------|------------------|---------------------------|-----------------------|-----------------|--------------------|
| 5 in 1<br>5 w 1  | U<br>0-600<br>~V | U<br>0-600<br>~V          | I<br>0-10<br>~A       | I<br>0-10<br>~A | R<br>0-40<br>MΩ    |
| C<br>0-100<br>μF | f<br>200<br>kHz  |                           | T<br>-20°+<br>+1000°C |                 | %RH<br>30%+<br>90% |
|                  |                  | AUTO RANGE<br>AUTO ZAKRES | AUTO POWER OFF        |                 |                    |



**YATO**  
YT-73087 24

|                       |                  |                         |                           |                 |                   |
|-----------------------|------------------|-------------------------|---------------------------|-----------------|-------------------|
| U<br>0-600<br>~V      | U<br>0-600<br>~V | I<br>0-10<br>~A         | I<br>0-10<br>~A           | R<br>0-20<br>MΩ | C<br>0-1000<br>μF |
| T<br>-20°+<br>+1000°C |                  | h <sub>FE</sub> PNP NPN | AUTO RANGE<br>AUTO ZAKRES | AUTO POWER OFF  |                   |



**YATO**  
YT-73084 44

|                   |                   |                  |                       |                 |                           |
|-------------------|-------------------|------------------|-----------------------|-----------------|---------------------------|
| TRUE RMS          | U<br>0-600<br>~V  | U<br>0-600<br>~V | I<br>0-10<br>~A       | I<br>0-10<br>~A | R<br>0-60<br>MΩ           |
| C<br>0-4000<br>μF | f<br>9.999<br>MHz |                  | T<br>-20°+<br>+1000°C |                 | AUTO RANGE<br>AUTO ZAKRES |
|                   |                   |                  |                       | AUTO POWER OFF  |                           |



**YATO**  
YT-73088 20



|                       |                  |                           |                  |
|-----------------------|------------------|---------------------------|------------------|
| U<br>0-600<br>~V      | U<br>0-600<br>~V | I<br>0-600<br>~A          | R<br>0-200<br>MΩ |
| T<br>-20°+<br>+1000°C |                  | AUTO RANGE<br>AUTO ZAKRES | AUTO POWER OFF   |
|                       |                  |                           |                  |



**YATO**  
YT-73091 20

- GB Electric glue gun
- D Heissklebepistole
- PL Pistolet do klejenia
- RUS Пистолет для клея
- CZ Pistole na lepení
- H Ragasztópisztoly
- RO Pistol pt. lipit
- F Pistolet à colle
- I Pistola colla
- E Pistola de cola
- CN 热胶枪

|               |                  |       |  |
|---------------|------------------|-------|--|
| 230V~<br>50Hz | 35<br>(400)<br>W | 11 mm |  |
|---------------|------------------|-------|--|

- GB Cordless glue gun
- D Heissklebepistole
- PL Akumulatorowy pistolet do klejenia
- RUS Пистолет для клея
- CZ Pistole na lepení

- H Ragasztópisztoly
- RO Pistol pt. lipit
- F Pistolet à colle
- I Pistola colla con batteria
- E Pistola de cola
- CN 热胶枪

|                           |  |    |       |
|---------------------------|--|----|-------|
| 7.4 V<br>2.6 Ah<br>Li-Ion |  | 8W | 11 mm |
|---------------------------|--|----|-------|



COLOR BOX



DOUBLE BLISTER

| YATO     | W        |       |
|----------|----------|-------|
| YT-82401 | 35 (400) | 12/24 |

| YATO     | W |      |
|----------|---|------|
| YT-82421 | 8 | 6/24 |

- GB Soldering station
- D Lötstation
- PL Stacja lutownicza
- RUS Паяльная станция
- CZ Letovací stanice
- H Forrasztópáka állomás
- RO Stație de lipit
- F Station de soudage
- I Stazione digitale di saldatura
- E Estación de soldadura
- CN 数显焊台

|               |     |               |                 |                |
|---------------|-----|---------------|-----------------|----------------|
| 230V~<br>50Hz | 48W | 150-450<br>°C | 7.1 mm<br>65 mm | LCD<br>DISPLAY |
|---------------|-----|---------------|-----------------|----------------|

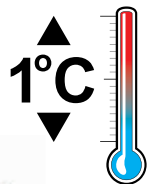

COLOR BOX

| YATO     | W  |   |
|----------|----|---|
| YT-82455 | 48 | 4 |



- GB Soldering iron  
D Lötkolben  
PL Lutownica oporowa  
RUS Электропаяльник
- CZ Pájka odporová  
H Forrasztópáka  
RO Ciocan de lipit  
F Fer à souder
- I Saldatore a stagno  
E Soldador de resistencia  
CN 电烙铁

230V~  
50Hz



HANGING  
DISPLAY  
COLOR BOX

| YATO    | W  | working temp. of soldering tip (°C) | dimensions of soldering tip (mm) |    |
|---------|----|-------------------------------------|----------------------------------|----|
| YT-8271 | 30 | 400                                 | ø3.8 x 70                        | 16 |
| YT-8272 | 60 | 500                                 | ø6.0 x 78                        | 16 |
| YT-8273 | 80 | 520                                 | ø6.8 x 64                        | 16 |

- GB Transformer soldering gun  
D Lötpestole  
PL Lutownica transformatorowa  
RUS Паяльник электрический  
CZ Transformátorová páječka  
H Forrasztópáka  
RO Aparat de lipit letcon cu transformator
- F Fer à souder  
I Saldatore istantaneo  
E Soldador transformador  
CN 电烙铁

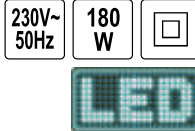

BMC  
& COLOR  
SLEEVE

| YATO    | W   |    |
|---------|-----|----|
| YT-8245 | 180 | 10 |

- GB Tweezer  
D Pinzette  
PL Pęseta  
RUS Пинцет
- CZ Pinzeta  
H Csipesz  
RO Pensetă  
F Pince
- I Pinza  
E Pinzas  
CN 镊子

SLIDING  
CARD



140  
mm

HRC  
30

| YATO    | L (mm) |        |
|---------|--------|--------|
| YT-6903 | 140    | 20/480 |



115  
mm

HRC  
30

| YATO    | L (mm) |        |
|---------|--------|--------|
| YT-6907 | 115    | 20/480 |



140  
mm

HRC  
40

| YATO    | L (mm) |        |
|---------|--------|--------|
| YT-6916 | 140    | 20/480 |

GB Insulation tape  
D Isolierband  
PL Taśma elektroizolacyjna  
RUS Изолента

CZ Izolační páska  
H Szigetelőszalag  
RO Banda izolatoare  
F Ruban électrique

I Nastro isolante  
E Cinta aislante  
CN 绝缘胶带

EN60454-3-1-1/F-PVC/60/R-Tp  
DIELECTRIC STRENGTH / WYTRZYMAŁOŚĆ DIELEKTRYCZNA > 35 Kv / mm  
ELONGATION / WYDŁUŻENIE > 125%  
FLAME TEST / TEST OGNIOWY < 1 s  
STORE TEMPERATURE / TEMPERATURA SKŁADOWANIA +10°C ~ +40°C  
USING TEMPERATURE / TEMPERATURA UŻYTKOWANIA +5°C ~ +50°C



| YATO    | dimensions / wymiary   |        |
|---------|------------------------|--------|
| YT-8152 | 12 mm x 10 m x 0.13 mm | 96/384 |
| YT-8159 | 15 mm x 20 m x 0.13 mm | 72/288 |
| YT-8165 | 19 mm x 20 m x 0.13 mm | 72/288 |
| YT-8174 | 25 mm x 20 m x 0.19 mm | 48/192 |
| YT-8177 | 50 mm x 33 m x 0.19 mm | 48     |

| YATO     | dimensions / wymiary   |        |
|----------|------------------------|--------|
| YT-81592 | 15 mm x 20 m x 0.13 mm | 72/288 |
| YT-8166  | 19 mm x 20 m x 0.13 mm | 72/288 |

7

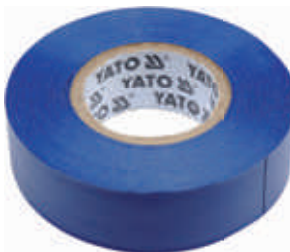

| YATO     | dimensions / wymiary   |        |
|----------|------------------------|--------|
| YT-81591 | 15 mm x 20 m x 0.13 mm | 72/288 |
| YT-81651 | 19 mm x 20 m x 0.13 mm | 72/288 |

| YATO     | dimensions / wymiary   |        |
|----------|------------------------|--------|
| YT-81594 | 15 mm x 20 m x 0.13 mm | 72/288 |
| YT-81654 | 19 mm x 20 m x 0.13 mm | 72/288 |



| YATO     | dimensions / wymiary   |        |
|----------|------------------------|--------|
| YT-81593 | 15 mm x 20 m x 0.13 mm | 72/288 |
| YT-81655 | 19 mm x 20 m x 0.13 mm | 72/288 |

| YATO     | dimensions / wymiary   |        |
|----------|------------------------|--------|
| YT-81595 | 15 mm x 20 m x 0.13 mm | 72/288 |
| YT-81652 | 19 mm x 20 m x 0.13 mm | 72/288 |



10  
PCS

10  
PCS

| YATO    | dimensions / wymiary   |       |
|---------|------------------------|-------|
| YT-8156 | 12 mm x 10 m x 0.13 mm | 10/40 |

| YATO    | dimensions / wymiary   |      |
|---------|------------------------|------|
| YT-8173 | 19 mm x 20 m x 0.13 mm | 6/24 |



Memo

# 8

**Hammers, chisels,  
punches & axes**  
**Młotki, dłuta,  
przecinaki i siekiery**





|   |   |     |
|---|---|-----|
| <b>Machinist hammers</b><br>Młotki ślusarskie |  | 156 |
|---|---|-----|

|   |   |     |
|---|---|-----|
| <b>Dead blow hammers</b><br>Młotki bezodrzutowe |  | 158 |
|---|---|-----|

|  |   |     |
|--|---|-----|
| <b>Stoning hammers</b><br>Młotki kamieniarskie |  | 156 |
|--|---|-----|

|   |   |         |
|---|---|---------|
| <b>Ball pein hammers &amp; sets</b><br>Młotki blacharskie i zestawy |  | 158-159 |
|---|---|---------|

|  |   |     |
|--|---|-----|
| <b>Hammers with tubular steel handle</b><br>Młotki z trzonkiem rurowym |  | 157 |
|--|---|-----|

|  |   |         |
|--|---|---------|
| <b>Chisels, cold chisels &amp; punches</b><br>Dłuta, przecinaki i przebijaki |  | 160-162 |
|--|---|---------|

|  |     |
|--|-----|
| <b>Claw hammers</b><br>Młotki szewskie.....            | 157 |
| <b>Roofing hammers</b><br>Młotki ciesielskie.....      | 157 |
| <b>Mason's hammers</b><br>Młotki murarskie.....        | 157 |
| <b>Plasterer's hatchets</b><br>Toporki tynkarskie..... | 157 |

|   |     |
|---|-----|
| <b>Wood chisels &amp; sets</b><br>Dłuta stolarskie i zestawy.....           | 160 |
| <b>Cold chisels</b><br>Przecinaki.....                                      | 160 |
| <b>Punches</b><br>Przebijaki.....   | 160 |
| <b>Pin punches</b><br>Wybijaki.....   | 161 |
| <b>Punches</b><br>Punktaki.....   | 161 |
| <b>Cold chisel &amp; punch sets</b><br>Zestawy przecinaków i punktaków..... | 161 |

|  |   |     |
|--|---|-----|
| <b>Fully drop forged hammers</b><br>Młotki monolityczne kute |  | 157 |
|--|---|-----|

|                              |  |     |
|------------------------------|--|-----|
| <b>Wrecking bars</b><br>Łomy |  | 163 |
|------------------------------|--|-----|

|   |     |
|---|-----|
| <b>Claw hammers</b><br>Młotki szewskie.....       | 157 |
| <b>Roofing hammers</b><br>Młotki ciesielskie..... | 157 |
| <b>Mason's hammers</b><br>Młotki murarskie.....   | 157 |

|                         |   |     |
|-------------------------|---|-----|
| <b>Axes</b><br>Siekiery |  | 163 |
|-------------------------|---|-----|

|  |   |     |
|--|---|-----|
| <b>Rubber mallets</b><br>Młotki gumowe |  | 158 |
|--|---|-----|

GB Machinist hammer CZ Zámečnické kladívko I Martello da aggiustatore  
 D Schlosserhammer H Vaskalapács E Martillo  
 PL Miotek ślusarski RO Ciocan de lăcătușerie CN 钳工锤  
 RUS Молоток слесарный F Marteau serrurier

DIN  
1041

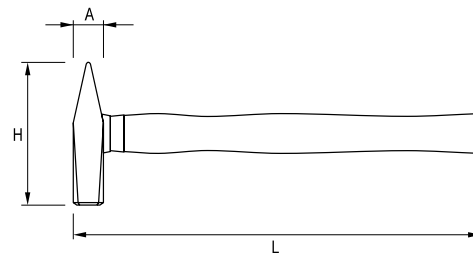

| YATO    | m (g) | L (mm) | A (mm) | H (mm) |        |
|---------|-------|--------|--------|--------|--------|
| YT-4491 | 100   | 260    | 15     | 80     | 12/120 |
| YT-4492 | 200   | 280    | 20     | 93     | 6/60   |
| YT-4493 | 300   | 300    | 21     | 103    | 6/60   |
| YT-4494 | 400   | 310    | 23     | 111    | 6/48   |
| YT-4495 | 500   | 320    | 26     | 118    | 6/36   |

| YATO    | m (g) | L (mm) | A (mm) | H (mm) |      |
|---------|-------|--------|--------|--------|------|
| YT-4496 | 600   | 330    | 28     | 119    | 6/36 |
| YT-4497 | 800   | 350    | 31     | 125    | 6/24 |
| YT-4498 | 1000  | 360    | 35     | 132    | 6/24 |
| YT-4499 | 1500  | 380    | 40     | 143    | 6/12 |
| YT-4500 | 2000  | 400    | 45     | 153    | 6/12 |

8

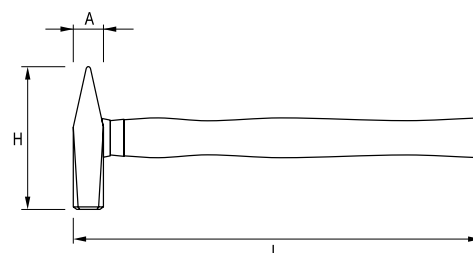

| YATO    | m (g) | L (mm) | A (mm) | H (mm) |        |
|---------|-------|--------|--------|--------|--------|
| YT-4501 | 100   | 260    | 15     | 82     | 12/120 |
| YT-4502 | 200   | 280    | 19     | 95     | 6/60   |
| YT-4503 | 300   | 300    | 23     | 105    | 6/60   |
| YT-4504 | 400   | 310    | 25     | 112    | 6/48   |
| YT-4505 | 500   | 320    | 27     | 118    | 6/36   |

| YATO    | m (g) | L (mm) | A (mm) | H (mm) |      |
|---------|-------|--------|--------|--------|------|
| YT-4506 | 600   | 330    | 29     | 122    | 6/36 |
| YT-4507 | 800   | 350    | 33     | 135    | 6/24 |
| YT-4508 | 1000  | 360    | 36     | 135    | 6/24 |
| YT-4509 | 1500  | 380    | 42     | 145    | 6/12 |
| YT-4510 | 2000  | 400    | 47     | 155    | 6/12 |

GB Safety stoning hammer H Kőtörő kalapács I Martello da aggiustatore  
 D Fäustel RO Ciocan pt. zidarie E Martillo  
 PL Miotek kamieniarski F Marteau de tailleur de pierres CN 石工锤  
 RUS Молоток каменщика  
 CZ Palička kovová

DIN  
6475

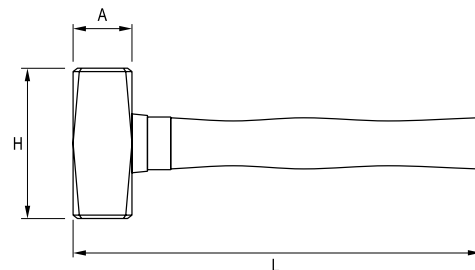

| YATO    | m (g) | L (mm) | A (mm) | H (mm) |      |
|---------|-------|--------|--------|--------|------|
| YT-4550 | 1000  | 260    | 40     | 95     | 6/24 |
| YT-4551 | 1250  | 260    | 43     | 100    | 6/24 |

| YATO    | m (g) | L (mm) | A (mm) | H (mm) |      |
|---------|-------|--------|--------|--------|------|
| YT-4552 | 1500  | 280    | 45     | 110    | 6/12 |
| YT-4553 | 2000  | 300    | 50     | 120    | 6/12 |



GB Claw hammer  
D Schusterhammer  
PL Młotek szewski  
RUS Молоток гвоздодёр  
CZ Ševcovské kladívko  
H Cipész kalapács

RO Ciocan de cizmărie  
F Marteau de cordonnier  
I Martello calzolaio  
E Martillo sacador  
CN 羊角锤



- high quality steel handle
- forged carbon steel head hardened and tempered
- stalowa rączka
- główka ze stali węglowej, kuta, ulepszona cieplnie

| YATO    | m (g) | L (mm) | A (mm) | H (mm) |      |
|---------|-------|--------|--------|--------|------|
| YT-4560 | 450   | 318    | 30     | 130    | 6/24 |

GB Mason's hammer, type B  
D Berliner Mauerhammer  
PL Młotek murarski berliński  
RUS Молоток каменщика широкий

F Marteau de maçon  
I Martello muratore tipo Berlin  
E Martillo de albanil de Berlín  
CN B型泥工锤



- high quality steel handle
- forged carbon steel head hardened and tempered
- stalowa rączka
- główka ze stali węglowej, kuta, ulepszona cieplnie

| YATO    | m (g) | L (mm) | A (mm) | H (mm) |      |
|---------|-------|--------|--------|--------|------|
| YT-4562 | 600   | 315    | 24x23  | 200    | 6/24 |

GB Plasterer's hatchet

D Gipserbeil  
PL Toporek tynkarski  
RUS Топор штукатурный  
CZ Omitáči sekyrka  
H Kőműves szekerce  
RO Toporaş de tencuit  
F Hachette de plâtrier  
I Martello con accetta  
E Hacha enlucido  
CN 多用斧



- high quality steel handle
- forged carbon steel head hardened and tempered
- stalowa rączka
- główka ze stali węglowej, kuta, ulepszona cieplnie

| YATO    | m (g) | L (mm) | A (mm) | H (mm) |      |
|---------|-------|--------|--------|--------|------|
| YT-4564 | 600   | 315    | 25x20  | 175    | 6/24 |

GB Roofing hammer  
D Latthammer Geschmiedet  
PL Młotek ciesielski  
RUS Молоток жестящика

F Marteau de charpentier  
I Martello calzolaio  
E Martillo techumbre  
CN 连体羊角锤



- high quality steel handle
- forged carbon steel head hardened and tempered
- stalowa rączka
- główka ze stali węglowej, kuta, ulepszona cieplnie

| YATO    | m (g) | L (mm) | A (mm) | H (mm) |      |
|---------|-------|--------|--------|--------|------|
| YT-4571 | 600   | 331    | 25x25  | 165    | 6/24 |

GB Roofing hammer  
D Latthammer Geschmiedet  
PL Młotek ciesielski  
RUS Молоток жестящика  
CZ Tesařské kladívko

H Ácskalapács  
RO Ciocan de dulgherie  
F Marteau de charpentier

I Martello per carpentiere  
E Martillo techumbre  
CN 独角锤



- high quality steel handle
- forged carbon steel head hardened and tempered
- stalowa rączka
- główka ze stali węglowej, kuta, ulepszona cieplnie

| YATO    | m (g) | L (mm) | A (mm) | H (mm) |      |
|---------|-------|--------|--------|--------|------|
| YT-4561 | 600   | 318    | 25x25  | 165    | 6/24 |

GB Mason's hammer, type R  
D Mauerhammer Rheinische Form  
PL Młotek murarski reński  
RUS Молоток каменщика узкий  
CZ Zednické kladívko renské

RO Ciocan de zidărie (tip ren)  
F Marteau de maçon  
I Martello muratore tipo rin  
E Martillo de albañil de Rin  
CN R型泥工锤



- high quality steel handle
- forged carbon steel head hardened and tempered
- stalowa rączka
- główka ze stali węglowej, kuta, ulepszona cieplnie

| YATO    | m (g) | L (mm) | A (mm) | H (mm) |      |
|---------|-------|--------|--------|--------|------|
| YT-4563 | 600   | 315    | 23x23  | 170    | 6/24 |

GB Claw hammer

D Schusterhammer  
PL Młotek szewski  
RUS Молоток гвоздодёр  
CZ Ševcovské kladívko  
H Cipész kalapács  
RO Ciocan de cizmărie  
F Marteau de cordonnier  
I Martello calzolaio  
E Martillo sacador  
CN 连体羊角锤



- high quality steel handle
- forged carbon steel head hardened and tempered
- stalowa rączka
- główka ze stali węglowej, kuta, ulepszona cieplnie

| YATO    | m (g) | L (mm) | A (mm) | H (mm) |      |
|---------|-------|--------|--------|--------|------|
| YT-4570 | 450   | 315    | 30     | 130    | 6/24 |

GB Mason's hammer, type R  
D Mauerhammer Rheinische Form  
PL Młotek murarski reński  
RUS Молоток каменщика узкий  
CZ Zednické kladívko renské

RO Ciocan de zidărie (tip ren)  
F Marteau de maçon  
I Martello muratore tipo rin  
E Martillo de albañil de Rin  
CN 连体R型泥工锤



- high quality steel handle
- forged carbon steel head hardened and tempered
- stalowa rączka
- główka ze stali węglowej, kuta, ulepszona cieplnie

| YATO    | m (g) | L (mm) | A (mm) | H (mm) |      |
|---------|-------|--------|--------|--------|------|
| YT-4573 | 600   | 382    | 25x24  | 158    | 6/24 |

- GB Rubber mallet with fibreglass, TPR handle  
 D Gummihammer mit Fiberglasstiel  
 PL Młotek gumowy z trzonkiem z włókna szklanego  
 RUS Киянка резиновая со стеклопластиковой ручкой  
 CZ Pryžové kladívko  
 H Gumikalapács
- RO Ciocan de cauciuc  
 F Maillet caoutchouc  
 I Martello mazzuola in gomma  
 E Mazo de goma  
 CN 纤维柄橡胶锤



| YATO    | m (g) | L (mm) | Ø (mm) | H (mm) |      |
|---------|-------|--------|--------|--------|------|
| YT-4594 | 440   | 340    | 50     | 87.5   | 6/36 |

- GB Dead blow mallet  
 D Rückschlagsfreier Schonhammer  
 PL Młotek bezodrzutowy  
 RUS Молоток безинерционный  
 CZ Palička nárazová plněná celogumová  
 H Visszarúgás mentes gumikalapács  
 RO Ciocan cu absorbție  
 F Maillet sans recul  
 I Martello morto colpo  
 E Martillo sin reacción  
 CN 防震无回弹橡胶锤

**PU**

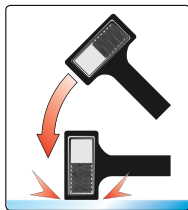

| YATO    | m (g) | L (mm) | Ø (mm) | H (mm) |      |
|---------|-------|--------|--------|--------|------|
| YT-4620 | 740   | 300    | 44.5   | 100.0  | 4/24 |
| YT-4622 | 900   | 336    | 53.5   | 100.0  | 4/24 |
| YT-4623 | 1300  | 350    | 59.0   | 118.5  | 3/12 |

- GB PU & nylon heads mallet  
 D Schonhammer mit PU & Nylon-Schlagkopf  
 PL Młotek blacharski  
 RUS Молоток рихтовочный  
 CZ Palička klempířská  
 H Vaskalapács  
 RO Ciocan tinichigerie cap PU / nylon  
 F Marteau spécial en PU/nylon  
 I Martello per lamiera  
 E Martillo chapista  
 CN 木柄安装锤



**PU** **NYLON**

- GB Rubber mallet with wooden handle  
 D Gummihammer mit Holzstiel  
 PL Młotek gumowy z drewnianym trzonkiem  
 RUS Молоток резиновый  
 CZ Pryžové kladívko  
 H Gumikalapács
- RO Ciocan de cauciuc  
 F Maillet caoutchouc  
 I Martello mazzuola in gomma  
 E Mazo de goma  
 CN 木柄橡胶锤



| YATO    | m (g) | L (mm) | Ø (mm) | H (mm) |       |
|---------|-------|--------|--------|--------|-------|
| YT-4600 | 230   | 259    | 44     | 71.0   | 12/48 |
| YT-4601 | 340   | 291    | 49     | 79.5   | 12/48 |
| YT-4602 | 370   | 300    | 50     | 87.5   | 6/36  |
| YT-4603 | 580   | 341    | 58     | 96.0   | 6/36  |
| YT-4604 | 780   | 341    | 63     | 117.0  | 6/36  |
| YT-4605 | 980   | 345    | 72     | 122.0  | 6/24  |

- GB Dead blow mallet  
 D Rückschlagsfreier Schonhammer  
 PL Młotek bezodrzutowy  
 RUS Молоток безинерционный  
 CZ Palička nárazová plněná celogumová  
 H Visszarúgás mentes gumikalapács
- RO Ciocan cu absorbție  
 F Maillet sans recul  
 I Martello morto colpo  
 E Martillo sin reacción  
 CN 尼龙安装锤

**PU**



| YATO    | m (g) | L (mm) | Ø (mm) | H (mm) |       |
|---------|-------|--------|--------|--------|-------|
| YT-4624 | 265   | 318    | 30.0   | 94     | 10/40 |
| YT-4625 | 430   | 350    | 40.0   | 100    | 6/36  |
| YT-4626 | 490   | 348    | 45.0   | 110    | 6/36  |

- GB PU head for mallet  
 D Polyurethan Schlagkopf  
 PL Końcówka PU do młotka  
 RUS Наконечник молотка из полиуретана  
 CZ Náhradní koncovka k paličce PU  
 H PU kalapácsfej cserélhető  
 RO Cap PU pt. ciocan tinichigerie  
 F Tête PU pour marteau  
 I Bocca PU di ricambio  
 E Cabeza PU para martillo chapista  
 CN PU软头

**PU**

**SOFT**  
**MIĘKKA**



| YATO    | Ø (mm) | for / dla |      |
|---------|--------|-----------|------|
| YT-4635 | 22     | YT-4630   | 6/60 |
| YT-4636 | 28     | YT-4631   | 6/60 |
| YT-4637 | 35     | YT-4632   | 6/60 |
| YT-4638 | 45     | YT-4633   | 6/60 |
| YT-4639 | 60     | YT-4634   | 6/60 |

- GB Nylon head for mallet  
 D Nylon Schlagkopf  
 PL Końcówka nylonowa do młotka  
 RUS Наконечник молотка из твердого нейлона  
 CZ Náhradní koncovka k paličce nylon  
 H Műanyag kalapácsfej cserélhető  
 RO Cap nylon pt. ciocan tinichigerie  
 F Tête nylon pour marteau  
 I Bocca di ricambio, nylon  
 E Cabeza de nylon para martillo chapista  
 CN 尼龙硬头

**NYLON**

**HARD**  
**TWARDA**



| YATO    | Ø (mm) | for / dla |      |
|---------|--------|-----------|------|
| YT-4640 | 22     | YT-4630   | 6/60 |
| YT-4641 | 28     | YT-4631   | 6/60 |
| YT-4642 | 35     | YT-4632   | 6/60 |
| YT-4643 | 45     | YT-4633   | 6/60 |
| YT-4644 | 60     | YT-4634   | 6/60 |



GB Auto body fender set  
D Karosserie-Ausbeulsatz  
PL Komplet młotków blacharskich  
RUS Молотки рихтовочные  
CZ Souprava klempířských kladívek  
H Bádogos kalapács készlet

RO Set de ciocane de tablă  
F Set pour carrossier  
I Martello per lamiera  
E Juego de mazos de hojalatero  
CN 钣金工具组套

7  
PCS



DROP  
FORGED  
KUTE

GENUINE  
HICKORY



BMC  
& COLOR  
SLEEVE





| YATO  | m (g) |  |
|--|-------|---|
| YT-4590  | 4900  | 4   |

GB Ball pein hammer  
D Ausbeulhammer  
PL Młotek blacharski  
RUS Молоток рихтовочный  
CZ Klempířské kladívko  
H Bádogos kalapács

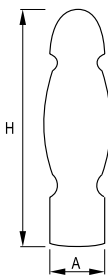
RO Ciocan pt. tabla  
F Marteau à panne ronde  
I Martello per lamiera  
E Martillo de hojalatero  
CN 圆头锤





| YATO  | m (g) | L (mm) | A (mm) | H (mm) |  |
|--|-------|--------|--------|--------|---|
| YT-4515  | 225   | 280    | 26     | 80     | 6/36  |
| YT-4516  | 450   | 315    | 34     | 100    | 6/24  |
| YT-4518  | 900   | 380    | 40     | 125    | 6/12  |

GB Ball pein hammer  
D Ausbeulhammer  
PL Młotek blacharski  
RUS Молоток рихтовочный  
CZ Klempířské kladívko  
H Bádogos kalapács

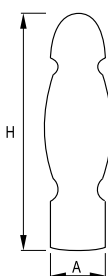
RO Ciocan pt. tabla  
F Marteau à panne ronde  
I Martello per lamiera  
E Martillo de hojalatero  
CN 圆头锤



| YATO  | m (g) | L (mm) | A (mm) | H (mm) |  |
|--|-------|--------|--------|--------|---|
| YT-4519  | 225   | 295    | 26     | 80     | 6/36  |
| YT-4520  | 450   | 335    | 35     | 100    | 6/24  |
| YT-4521  | 680   | 360    | 36     | 115    | 6/12  |
| YT-4522  | 900   | 380    | 40     | 125    | 6/12  |

GB Wood chisel  
 D Stechbeitel  
 PL Dłuto stolarskie  
 RUS Долото  
 CZ Rezbáfské dláto  
 H Asztalos véső

RO Daltă de tâmplărie  
 F Ciseau  
 I Scalpello  
 per falegname  
 E Cincel para madera  
 CN 木工凿

DOUBLE BLISTER

CrV 60  
 HRC 56-62



| YATO    | size / rozmiar (mm) |       |
|---------|---------------------|-------|
| YT-6241 | 8                   | 10/60 |
| YT-6242 | 10                  | 10/60 |
| YT-6243 | 12                  | 10/60 |
| YT-6244 | 14                  | 10/60 |
| YT-6245 | 15                  | 10/60 |
| YT-6246 | 16                  | 10/60 |
| YT-6247 | 18                  | 10/60 |

| YATO    | size / rozmiar (mm) |       |
|---------|---------------------|-------|
| YT-6248 | 20                  | 10/60 |
| YT-6249 | 22                  | 10/60 |
| YT-6251 | 25                  | 10/60 |
| YT-6253 | 28                  | 10/60 |
| YT-6256 | 35                  | 10/60 |
| YT-6258 | 38                  | 10/60 |

GB Chisel set  
 D Meißelsatz  
 PL Zestaw dłut  
 RUS Набор зубил

CZ Sada dlát  
 H Hidegvágó készlet  
 RO Set de dălți  
 F Set de ciseaux à bois

I Set scalpelli  
 E Juego de cinceles  
 CN 木工凿组套

4 PCS  
 10 16 20 25 mm  
 CrV 60  
 HRC 58-60



| YATO    |      |
|---------|------|
| YT-6260 | 5/20 |

GB Chisel set  
 D Meißelsatz  
 PL Zestaw dłut  
 RUS Набор зубил

CZ Sada dlát  
 H Hidegvágó készlet  
 RO Set de dălți  
 F Set de ciseaux à bois

I Set scalpelli  
 E Juego de cinceles  
 CN 木工凿组套

3 PCS  
 CrV  
 16 25 32 mm  
 PLASTIC HANGER



| YATO    |       |
|---------|-------|
| YT-6280 | 10/30 |

4 PCS  
 CrV  
 10 12 16 20 mm  
 PLASTIC HANGER



| YATO    |      |
|---------|------|
| YT-6281 | 6/24 |

GB Cold chisel with protection  
 D Schlitzmeißel mit Handschutz  
 PL Przecinak z osłoną  
 RUS Зубило с протектором  
 CZ Plochy sekáč (z krytem)  
 H Hidegvágó, lapos (védőfejjel)

RO Daltă - tăietor  
 plată (cu apărătoare)  
 F Burin  
 I Scalpello con protezione  
 E Cincel plano (con protector)  
 CN 石工凿

25x300 mm  
 CrV



| YATO    | L (mm) |      |
|---------|--------|------|
| YT-4700 | 300    | 4/24 |

GB Cold chisel with protection  
 D Schlitzmeißel mit Handschutz  
 PL Przecinak z osłoną  
 RUS Зубило с протектором  
 CZ Plochy sekáč (z krytem)  
 H Hidegvágó, lapos (védőfejjel)  
 RO Daltă - tăietor plată (cu apărătoare)

F Burin  
 I Scalpello con protezione  
 E Cincel plano (con protector)  
 CN 石工凿

76x267 mm  
 CrV



| YATO    | L (mm) |      |
|---------|--------|------|
| YT-4701 | 267    | 4/24 |

GB Punch with protection  
 D Spitzmeißel mit Handschutz  
 PL Przebijak z osłoną  
 RUS Скарпель с пластмассовой ручкой  
 CZ Zednický průbojník (z krytem)  
 H Falvéső (védőfejjel)  
 RO Dom (perforator) pt. perete (cu apărătoare)  
 F Perçoir  
 I Scalpello a punta con protezione  
 E Cincel de cerrajería con protector  
 CN 水泥尖凿

300 mm  
 CrV



| YATO    | L (mm) |      |
|---------|--------|------|
| YT-4705 | 300    | 4/24 |

GB Chisel and punch set  
 D Trennmeißel- und Durchtreiber-Satz  
 PL Zestaw przecinaków i punktaków  
 RUS Зубила и пробойники с протектором  
 CZ Sekáče a průbojníky  
 H Véső és lyukasztó készlet

RO Set dalti de impact  
 F Kit de burins et perçoirs  
 I Scalpelli e bulino  
 E Juego de cinceles de acero templado y punzones  
 CN 冲凿组套

6 PCS  
 CHISEL 12x180 mm 16x180 mm 19x180 mm  
 PUNCH 3x180 mm 3x180 mm 4x180 mm  
 CrV



| YATO    | L (mm) |       |
|---------|--------|-------|
| YT-4710 | 180    | 10/20 |



- GB** Cold chisel  
**D** Flachmeißel  
**PL** Przecinak płaski  
**RUS** Зубило плоское  
**CZ** Sekáč plochý  
**H** Laposvágó
- RO** Dalta lata  
**F** Burin  
**I** Scalpello a punta  
**E** Tajadera en frío  
**CN** 凿子



CrV  
6150



SLIDING  
CARD

| YATO     | L (mm) | chisel width / szerokość dłuta (mm) |        |
|----------|--------|-------------------------------------|--------|
| YT-47147 | 142    | 10.0                                | 20/120 |
| YT-47148 | 152    | 12.5                                | 20/120 |
| YT-47149 | 172    | 16.0                                | 20/120 |

- GB** Taper punch  
**D** Durchtreiber  
**PL** Dobijak stożkowy  
**RUS** Пробойник конусный  
**CZ** Průbojník  
**H** Lyukasztó
- RO** Dorn conic  
**F** Percuteur  
**I** Scalpello a punta  
**E** Retacador de cono  
**CN** 冲子

150  
mm



CrV  
6150



SLIDING  
CARD

| YATO     | L (mm) | pin diameter / średnica grotu (mm) |        |
|----------|--------|------------------------------------|--------|
| YT-47141 | 150    | 1.5                                | 20/120 |
| YT-47142 | 150    | 3.0                                | 20/120 |
| YT-47143 | 150    | 4.0                                | 20/120 |
| YT-47144 | 150    | 5.0                                | 20/120 |
| YT-47145 | 150    | 6.0                                | 20/120 |
| YT-47146 | 150    | 8.0                                | 20/120 |

- GB** Taper punch  
**D** Durchtreiber  
**PL** Dobijak stożkowy  
**RUS** Пробойник конусный  
**CZ** Průbojník  
**H** Lyukasztó  
**RO** Dorn conic
- F** Matoir  
**I** Scalpello a punta  
**E** Retacador de cono  
**CN** 冲子

SLIDING  
CARD



140  
mm



CrV  
6150



| YATO     | L (mm) | center punch / średnica punktaka (mm) |        |
|----------|--------|---------------------------------------|--------|
| YT-47152 | 140    | 2.0                                   | 20/120 |

- GB** Center punch  
**D** Körner  
**PL** Punktak  
**RUS** Пробойник - керн  
**CZ** Důlčik  
**H** Pontozó  
**RO** Punctator
- F** Pointeau  
**I** Punzoni  
**E** Retacador - punzón centrador  
**CN** 冲子

SLIDING  
CARD



CrV  
6150



| YATO     | L (mm) | taper point end / średnica stożka (mm) |        |
|----------|--------|--|--------|
| YT-47150 | 100    | 6.0                                    | 20/120 |
| YT-47151 | 112    | 8.0                                    | 20/120 |

- GB** Pin punch set  
**D** Splintentreiber Satz  
**PL** Zestaw wybijaków  
**RUS** Пробойник булавочный- набор  
**CZ** Sada vyrážečů  
**H** Csapszegkiütő készlet
- RO** Set de dornuri  
**F** Set de perceuteurs  
**I** Set scalpelli  
**E** Juego de punzones  
**CN** 销式冲子组套

SLIDING  
CARD



6  
PCS

150  
mm



Pin diameter:  
1.5, 3.0, 4.0,  
5.0, 6.0,  
8.0 mm

CrV  
6150



| YATO     | L (mm) |      |
|----------|--------|------|
| YT-47121 | 150    | 6/24 |

- GB** Chisel set  
**D** Flachmeißelsatz  
**PL** Zestaw przecinaków  
**RUS** Зубила в наборе  
**CZ** Sekáče  
**H** Hídegvágó
- RO** Set dalti zidarie  
**F** Set de burins  
**I** Set scalpelli  
**E** Cinceles  
**CN** 冲凿组套

PLASTIC  
HANGER



3  
PCS

CHISEL  
10x142 mm  
12x152 mm  
16x172 mm

CrV

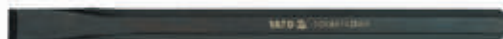

| YATO    |      |
|---------|------|
| YT-4711 | 6/24 |

- GB** Chisel and punch set  
**D** Trennmeißel- und Durchtreiber-Satz  
**PL** Zestaw przecinaków i punktaków  
**RUS** Зубила, керны и пробойники в наборе  
**CZ** Sekáče a průbojníky  
**H** Véső és lyukasztó készlet  
**RO** Set dalti de impact  
**F** Set de burins et pointeaux  
**I** Set scalpelli  
**E** Juego de cinceles de acero templado y punzones  
**CN** 冲凿组套

PLASTIC  
HANGER



6  
PCS

CHISEL  
10x142  
12x152  
mm

PUNCH  
2x140 mm  
3x152 mm  
6x152 mm  
8x115 mm

CrV

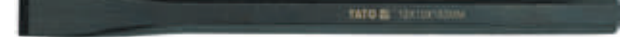
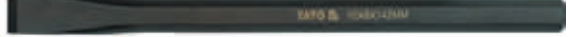
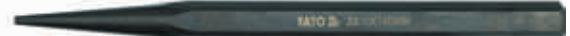

| YATO    |      |
|---------|------|
| YT-4712 | 6/24 |

GB Mini cold chisel and punch set  
 D Trennmeissel- und Durchtreiber-Satz  
 PL Zestaw wybijaków i przecinaków  
 RUS Зубила и керны в наборе  
 CZ Sekáče a průbojníky  
 H Véső és lyukasztó készlet  
 RO Set dalti de impact  
 F Set de burins et perceuteurs mini  
 I Set scalpelli e bulini  
 E Juego de cinceles de acero templado y punzones  
 CN 迷你冲凿组套

PLASTIC HANGER



3 PCS 125 mm  
 CrV COLD CHISEL: 10 mm  
 PIN PUNCH: 3 mm SOLID PUNCH: 3 mm



**YATO** YT-4713 10/60

GB Chisel and punch set  
 D Trennmeissel- und Durchtreiber-Satz  
 PL Zestaw przecinaków i punktaków  
 RUS Зубила, керны и пробойники в наборе  
 CZ Sekáče a průbojníky  
 H Véső és lyukasztó készlet  
 RO Set dalti de impact  
 F Set de burins et pointeaux  
 I Set scalpelli  
 E Juego de cinceles de acero templado y punzones  
 CN 冲凿组套

PLASTIC HANGER



12 PCS CrV SOLID PUNCH: 4 mm CENTER PUNCH: 90 DEGR. 6 mm 8 mm  
 PIN PUNCH: 1.5 mm 3 mm 4 mm 5 mm 6 mm 8 mm  
 COLD CHISEL: 10 mm 13 mm 16 mm



**YATO** YT-4714 10/20

GB Pin punch  
 D Splintentreiber  
 PL Wybijał  
 RUS Пробойник булавочный  
 CZ Vyrážec  
 H Csapszegkiütő

RO Dorn cilindric  
 F Percuteur  
 I Punzoni  
 E Punzón expulsador  
 CN 销式冲子

SLIDING CARD



150 mm CrV 60 PIN DIAMETER: ø 3.8 mm



**YATO** YT-4690 L (mm) 20/120

GB Taper punch  
 D Durchtreiber  
 PL Dobijał stożkowy  
 RUS Пробойник конусный  
 CZ Průbojník  
 H Lyukasztó  
 RO Dorn conic

F Matoir  
 I Punzoni  
 E Retacador de cono  
 CN 冲孔器

SLIDING CARD



120 mm CrV 60 CENTER PUNCH: ø 3.3 mm



**YATO** YT-4691 L (mm) 20/120

GB Center punch  
 D Körner  
 PL Dobijał punktowy  
 RUS Пробойник - керн  
 CZ Důlčák  
 H Pontozó

RO Punctator  
 F Pointeau  
 I Punzoni  
 E Retacador - punzón centrador  
 CN 冲子

SLIDING CARD



120 mm CrV 60 TAPER POINT END



**YATO** YT-4692 L (mm) 20/120

GB Cold chisel  
 D Flach Meissel  
 PL Przecinak płaski  
 RUS Зубило плоское  
 CZ Sekáč plochý  
 H Laposvágó

RO Dalta lata  
 F Burin plat  
 I Scalpello piatto  
 E Tajadera en frío  
 CN 扁铲

SLIDING CARD



130 mm CrV 60 CHISEL WIDTH: 12 mm



**YATO** YT-4693 L (mm) 20/120

GB Cape chisel  
 D Kreuzmeissel  
 PL Przecinak prostokątny  
 RUS Зубило „лика”  
 CZ Sekáč křížový  
 H Keresztvágó  
 RO Dalta ascuțita

F Burin  
 I Scalpello rettangolare  
 E Tajadera rectangular  
 CN 钎头

SLIDING CARD



130 mm CrV 60 CHISEL WIDTH: 5.5 mm



**YATO** YT-4694 L (mm) 20/120

GB Chisel and punch set  
 D Trennmeissel- und Durchtreiber-Satz  
 PL Zestaw przecinaków i punktaków  
 RUS Зубила и керны в наборе  
 CZ Sekáče a průbojníky  
 H Véső és lyukasztó készlet  
 RO Set dalti de impact  
 F Set de burins  
 I Set scalpelli e bulino  
 E Juego de cinceles de acero templado y punzones  
 CN 样冲组套

SLIDING CARD



5 PCS CrV 60 PIN PUNCH: ø 3.8 mm TAPER PUNCH: ø 3.3 mm  
 TAPER POINT END COLD CHISEL: 12 mm  
 CAPE CHISEL: 5.5 mm



**YATO** YT-4695 6/24



GB Hexagonal wrecking bar  
D Brechstange  
PL Łom sześciokątny  
RUS Лом-гвоздодёр шестигранный  
CZ Šestiúhľé páčidlo  
H Hatszögű feszítővas  
RO Ranga pt. scos cuie  
F Pied-de-biche manche hexagonal  
I Mazza di ferro  
E Palanqueta  
CN 撬棒

**DROP FORGED KUTE**



| YATO     | size / rozmiar (mm) |      |
|----------|---------------------|------|
| YT-46800 | 400x18              | 6/12 |
| YT-46801 | 450x18              | 6/12 |
| YT-46802 | 600x18              | 6/12 |
| YT-46803 | 750x18              | 6/12 |
| YT-46804 | 900x18              | 5/10 |

GB Profiled wrecking bar  
D Nageleisen  
PL Łom profilowany  
RUS Лом-гвоздодёр  
CZ Páčidlo  
H Szögűhúzó  
RO Ranga pt. scos cuie  
F Pied-de-biche profilé  
I Mazza di ferro  
E Palanqueta  
CN 撬棒

**DROP FORGED KUTE**



| YATO     | size / rozmiar (mm) |      |
|----------|---------------------|------|
| YT-46810 | 350x22x13           | 6/12 |
| YT-46811 | 450x30x17           | 6/12 |
| YT-46812 | 600x30x17           | 4/8  |
| YT-46813 | 750x30x17           | 4/8  |
| YT-46814 | 900x30x17           | 3/6  |

GB Flat wrecking bar  
D Nageleisen spitze  
PL Łom płaski  
RUS Лом плоский  
CZ Páčidlo ploché  
H Lapos feszítővas  
RO Ranga plata  
F Pied-de-biche plat  
I Mazza di ferro  
E Palanqueta  
CN 撬棒

**DROP FORGED KUTE**



| YATO     | size / rozmiar (mm) |       |
|----------|---------------------|-------|
| YT-46820 | 300x35x6            | 10/30 |
| YT-46821 | 380x35x6            | 10/20 |
| YT-46822 | 450x35x6            | 10/20 |
| YT-46823 | 600x35x6            | 10/20 |

GB Go-through pry bar set  
D Nageleisensatz  
PL Zestaw łomów

RUS Набор ломов  
CZ Sada mini páčidel  
H Szögűhúzó készlet

RO Set leviere  
F Set de pieds-de-biche  
I Set mazza di ferro

E Juego de palancas de hierro  
CN 穿心撬棒组套

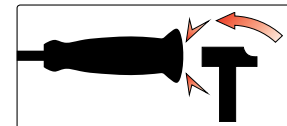

**4 PCS**

- 198x6x6 mm, 110 g
- 304x10x10 mm, 292 g
- 456x10x10 mm, 479 g
- 608x12x12 mm, 745 g

DOUBLE BLISTER

| YATO    |  |     |
|---------|--|-----|
| YT-4730 |  | 3/6 |

GB Axe  
D Beil Hicorystiel  
PL Siekiera

RUS Топор  
CZ Sekerka  
H Szekerce

RO Secure  
F Hache  
I Ascia

E Hacha  
CN 把斧

**DIN 5131 7294**

**GENUINE HICKORY**

Timber wedge and steel ring

Genuine hickory shaft



Forged carbon steel head hardened and tempered

| YATO    | m (g) | L (mm) | DIN  |    |
|---------|-------|--------|------|----|
| YT-8001 | 600   | 360    | 5131 | 24 |
| YT-8002 | 800   | 380    | 5131 | 20 |
| YT-8003 | 1000  | 430    | 5131 | 12 |
| YT-8004 | 1250  | 710    | 7294 | 12 |
| YT-8005 | 1400  | 710    | 7294 | 12 |
| YT-8006 | 1600  | 810    | 7294 | 12 |

GB Axe  
D Beil Hicorystiel  
PL Siekiera

RUS Топор  
CZ Sekerka  
H Szekerce

RO Secure  
F Hache  
I Ascia

E Hacha  
CN 把斧

**GENUINE HICKORY**

Timber wedge and steel ring

Genuine hickory shaft



Forged carbon steel head hardened and tempered

| YATO    | m (g) | L (mm) |   |
|---------|-------|--------|---|
| YT-8011 | 1000  | 515    | 6 |
| YT-8012 | 2000  | 820    | 6 |

# 9

## Clamps, vices & holders Ściski, imadła i wsporniki





Clamps  
Ściski



166

Magnetic holders  
Wsporniki magnetyczne



168

Vices  
Imadła



167

- GB F-clamp
- D Schraubzwinde
- PL Ścisk stolarski
- RUS Струбцина
- CZ Truhlářské upínadlo
- H Asztalos szorító
- RO Menghină pt. tâmplărie
- F Presse à serrage pour menuisier
- I Morsetto da falegname
- E Tornillo de apriete
- CN F夹钳



**QUICK ADJUSTMENT SZYBKĄ REGULACJĄ**



**QUICK ADJUSTMENT SZYBKĄ REGULACJĄ**

| YATO    | L (mm) |       |
|---------|--------|-------|
| YT-6401 | 160x80 | 10/30 |
| YT-6402 | 200x80 | 10/30 |
| YT-6403 | 250x80 | 10/30 |
| YT-6404 | 300x80 | 10/30 |
| YT-6405 | 450x80 | 10/20 |

| YATO    | L (mm)  |       |
|---------|---------|-------|
| YT-6406 | 600x80  | 10/20 |
| YT-6407 | 400x120 | 10    |
| YT-6408 | 500x120 | 10    |
| YT-6409 | 600x120 | 10    |
| YT-6410 | 900x120 | 5     |

| YATO    | L (mm)   |    |
|---------|----------|----|
| YT-6412 | 300x120  | 10 |
| YT-6413 | 400x120  | 10 |
| YT-6414 | 500x120  | 5  |
| YT-6415 | 600x120  | 5  |
| YT-6416 | 900x120  | 5  |
| YT-6417 | 1050x120 | 5  |



| YATO    | L (mm) |       |
|---------|--------|-------|
| YT-6440 | 100x50 | 12/60 |
| YT-6441 | 150x50 | 12/48 |
| YT-6442 | 200x50 | 12/48 |
| YT-6443 | 250x50 | 12/48 |
| YT-6444 | 300x50 | 12/48 |
| YT-6445 | 200x80 | 10/20 |
| YT-6446 | 250x80 | 10/20 |
| YT-6447 | 300x80 | 10/20 |

| YATO    | L (mm)   |       |
|---------|----------|-------|
| YT-6448 | 500x80   | 10/20 |
| YT-6449 | 300x120  | 10    |
| YT-6450 | 500x120  | 10    |
| YT-6451 | 800x120  | 6     |
| YT-6452 | 1000x120 | 6     |
| YT-6453 | 1200x120 | 6     |
| YT-6454 | 1500x120 | 6     |

- GB Quick release clamp
- D Schnellklemme
- PL Ścisk szybkozaciskowy
- RUS Быстрозажимная струбцина
- CZ Svěrka rychloupínací
- H Gyors asztalos szorító
- RO Clemă cu prindere rapidă

- F Presse à serrage rapide pour menuisier
- I Morsetto rapido
- E Aprietador rápido
- CN 快速夹



**QUICK ADJUSTMENT SZYBKĄ REGULACJĄ**

| YATO     | L (mm) | max. expand range / max. zasięg rozpięcia (mm) | max. clamping range / max. zasięg ściskania (mm) | max. jaws depth / max. głębokość szczęk (mm) |      |
|----------|--------|--|--|--|------|
| YT-64280 | 200    | 247-515  | 0-203  | 92   | 6/18 |
| YT-64281 | 300    | 247-616  | 0-304  | 92   | 6/12 |
| YT-64282 | 450    | 247-769  | 0-457  | 92   | 6/12 |
| YT-64283 | 600    | 247-921  | 0-609  | 92   | 6/12 |
| YT-64284 | 750    | 247-1074                                       | 0-762  | 92   | 4/8  |

| YATO     | L (mm) | max. expand range / max. zasięg rozpięcia (mm) | max. clamping range / max. zasięg ściskania (mm) | max. jaws depth / max. głębokość szczęk (mm) |      |
|----------|--------|--|--|--|------|
| YT-64290 | 200    | 206-456  | 0-203  | 85   | 6/18 |
| YT-64291 | 300    | 206-557  | 0-304  | 85   | 6/18 |
| YT-64292 | 450    | 206-710  | 0-457  | 85   | 6/12 |
| YT-64293 | 600    | 206-862  | 0-609  | 85   | 6/12 |
| YT-64294 | 750    | 206-1015                                       | 0-762  | 85   | 6/12 |
| YT-64295 | 900    | 206-1167                                       | 0-914  | 85   | 6/12 |

- GB Spring clamp
- D Federklemme
- PL Ścisk sprężynowy
- RUS Струбцина
- CZ Pružinové upínadlo
- H Rugós szorító
- RO Cleste presa pt. lemn
- F Pince de serrage
- I Morsetto a molla
- E Pinza
- CN 弹簧夹



| YATO     | L (mm) | max. jaws range / max. zasięg szczęk (mm) | max. jaws depth / max. głębokość szczęk (mm) |        |
|----------|--------|---|--|--------|
| YT-64270 | 100    | 42  | 44   | 24/240 |
| YT-64271 | 150    | 55  | 68   | 12/120 |
| YT-64272 | 200    | 79  | 91   | 10/100 |

- GB C-Clamp
- D C-Schraubzwinde
- PL Ścisk typu „C”
- RUS Струбцина типа „C”
- CZ Svěrka tvaru „C”
- H Pillanatszorító
- RO Menghină tip „C”
- F Serre-joint
- I Morsetto tipo „C”
- E Tornillo tipo „C”
- CN 深喉型C型夹



**DROP FORGED KUTE**

| YATO    | size / rozmiar (mm) | force pressure / siła nacisku (kg) |      |
|---------|---------------------|------------------------------------|------|
| YT-6420 | 50                  | 1500                               | 6/30 |
| YT-6421 | 75                  | 1950                               | 6/18 |
| YT-6422 | 100                 | 2980                               | 6/12 |
| YT-6423 | 150                 | 3200                               | 6/12 |
| YT-6424 | 200                 | 3600                               | 6    |



GB Swivel base bench vice  
D Drehbare Schraubstock  
PL Imadło ślusarskie obrotowe  
RUS Тиски слесарные поворотные  
CZ Zámečnický svěrák otáčivě  
H Satu, lakatos forgó  
RO Menghină rotativă  
F Étau rotatif de serrurier  
I Morsa a cerniera  
E Tornillo de apriete giratorio  
CN 台虎钳

COLOR BOX



GB Swivel base bench vice  
D Drehbare Schraubstock  
PL Imadło ślusarskie obrotowe  
RUS Тиски слесарные поворотные  
CZ Zámečnický svěrák otáčivě  
H Satu, lakatos forgó  
RO Menghină rotativă  
F Étau rotatif de serrurier  
I Morsa a cerniera  
E Tornillo de apriete giratorio  
CN 台虎钳

COLOR BOX

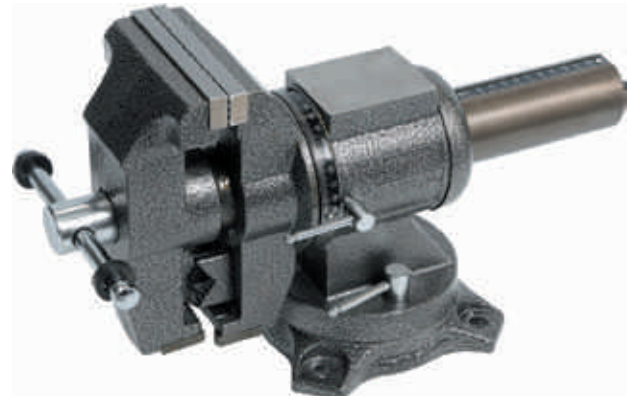

- anvil and changeable jaws made of hardened steel
- kowadełko i wymienne szczęki z hartowanej stali

|  |             |             |                          |   |
|--|-------------|-------------|--------------------------|---|
|  | <b>7 kg</b> | <b>YATO</b> | weight (kg)<br>waga (kg) |   |
|  |             | YT-6501     | 7                        | 2 |

|  |              |             |                          |   |
|--|--------------|-------------|--------------------------|---|
|  | <b>10 kg</b> | <b>YATO</b> | weight (kg)<br>waga (kg) |   |
|  |              | YT-6502     | 10                       | 2 |

|  |              |             |                          |   |
|--|--------------|-------------|--------------------------|---|
|  | <b>15 kg</b> | <b>YATO</b> | weight (kg)<br>waga (kg) |   |
|  |              | YT-6503     | 15                       | 1 |

|  |              |             |                          |   |
|--|--------------|-------------|--------------------------|---|
|  | <b>19 kg</b> | <b>YATO</b> | weight (kg)<br>waga (kg) |   |
|  |              | YT-65048    | 19                       | 1 |

|  |              |             |                          |   |
|--|--------------|-------------|--------------------------|---|
|  | <b>21 kg</b> | <b>YATO</b> | weight (kg)<br>waga (kg) |   |
|  |              | YT-6504     | 21                       | 1 |

|  |                |             |                          |   |
|--|----------------|-------------|--------------------------|---|
|  | <b>29.5 kg</b> | <b>YATO</b> | weight (kg)<br>waga (kg) |   |
|  |                | YT-65049    | 29.5                     | 1 |

- anvil and changeable jaws made of hardened steel
- kowadełko i wymienne szczęki z hartowanej stali

|  |  |  |  |                                 |              |
|--|--|--|--|---------------------------------|--------------|
|  |  |  |  | <b>HRC 45-52</b><br>JAWISZCZĘKI | <b>10 kg</b> |
|--|--|--|--|---------------------------------|--------------|

|             |                          |   |
|-------------|--------------------------|---|
| <b>YATO</b> | weight (kg)<br>waga (kg) |   |
| YT-6505     | 10                       | 1 |

|  |  |  |  |                                 |              |
|--|--|--|--|---------------------------------|--------------|
|  |  |  |  | <b>HRC 45-52</b><br>JAWISZCZĘKI | <b>20 kg</b> |
|--|--|--|--|---------------------------------|--------------|

|             |                          |   |
|-------------|--------------------------|---|
| <b>YATO</b> | weight (kg)<br>waga (kg) |   |
| YT-6506     | 20                       | 1 |

GB Hinged pipe vice  
D Rohrschraubstock  
PL Imadło zaciskowe do rur  
RUS Тиски для труб  
CZ Uprínací svěrák na trubky  
H Satu, csőszorító  
RO Menghină pt. țevi  
F Étau de serrage à tuyaux  
I Morsa stringi tubo  
E Tornillo de apriete para tubos  
CN 管子台虎钳



**S55C**

COLOR BOX



|             |        |   |
|-------------|--------|---|
| <b>YATO</b> | Ø (mm) |   |
| YT-6510     | 60     | 4 |
| YT-6511     | 76     | 2 |
| YT-6512     | 90     | 2 |
| YT-6513     | 110    | 1 |

- GB Adjustable angle welding magnet
- D Verstellbarer Magnet-Werkstückhalter
- PL Wspornik magnetyczny spawalniczy regulowany
- RUS Регулируемый магнит заварки угла
- CZ Polohovací magnetický držák ke svařování
- H Állítható, mágneses, hegesztő támasz
- RO Dispozitiv magnetic reglabil pt. sudura
- F Support magnétique de soudure
- I Supporto della saldatura magnetico
- E Soporte magnético de soldadura, ajustable
- CN 焊接磁铁



DOUBLE BLISTER



| YATO    | (kg)   | mm       |   |
|---------|--------|----------|---|
| YT-0862 | 2x22.5 | 85x65x22 | 6 |

- GB Magnetic welding holder
- D Magnet-Werkstückhalter
- PL Kałownik magnetyczny spawalniczy
- RUS Магнитная струбина заварки

- CZ Magnetický uhelník ke svařování
- H Mágneses, hegesztő szögvas
- RO Dispozitiv magnetic fixare pt. sudura
- F Support magnétique de soudure

- I Angolo magnetico da saldatura
- E Escuadra magnética de soldadura
- CN 焊接磁铁

DOUBLE BLISTER



| YATO    | (kg) | mm        |      |
|---------|------|-----------|------|
| YT-0863 | 11.5 | 82x120x13 | 6/48 |



| YATO    | (kg) | ∅(mm) | mm         |      |
|---------|------|-------|------------|------|
| YT-0864 | 22.5 | 18    | 102x155x17 | 6/30 |
| YT-0865 | 34.0 | 46    | 122x190x25 | 6/18 |

- GB Magnetic welding holder
- D Magnet-Werkstückhalter
- PL Kałownik magnetyczny spawalniczy
- RUS Магнитная струбина заварки

- CZ Magnetický uhelník ke svařování
- H Mágneses, hegesztő szögvas
- RO Dispozitiv magnetic fixare pt. sudura
- F Support magnétique de soudure

- I Triangolo magnetico da saldatura con interruttore
- E Escuadra magnética de soldadura
- CN 焊接磁铁

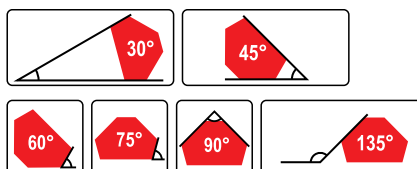

DOUBLE BLISTER



| YATO    | (kg) | mm         |      |
|---------|------|------------|------|
| YT-0866 | 11.5 | 64x95x14   | 6/24 |
| YT-0867 | 34.0 | 111x136x24 | 6/18 |

- GB Magnetic welding holder with switch
- D Magnet-Werkstückhalter mit Schalter
- PL Kałownik magnetyczny spawalniczy z wyłącznikiem
- RUS Магнитный держатель заварки с выключателем

- CZ Magnetický uhelník ke svařování s vypínačem
- H Mágneses, hegesztő szögvas, kapcsolóval
- RO Dispozitiv magnetic fixare pt. sudura cu intreruptor
- F Support magnétique de soudure

- I Triangolo magnetico da saldatura con interruttore
- E Escuadra magnética de soldadura, con interruptor
- CN 焊接磁铁

DOUBLE BLISTER



| YATO    | (kg) | mm         |      |
|---------|------|------------|------|
| YT-0870 | 13.5 | 107x160x26 | 6/24 |



Memo

# 10

## Cutting tools Narzędzia tnące

**YATO** 

item number:  
YT-6068

GB TCT circular saw blade for cutting of wood

D Hartmetallbestückt

Kreissägeblatt

für schneiden von Holz

PL Pila tarczowa do drewna

z węglikiem wolframu

RUS Пила дисковая по дереву

(твердый сплав)

210x30x3.2x2.2H

60T



10000 obr/min

**YATO** 

item number:  
YT-6068

GB TCT circular saw blade for cutting of wood

D Hartmetallbestückt

Kreissägeblatt

für schneiden von Holz

PL Pila tarczowa do drewna

z węglikiem wolframu

RUS Пила дисковая по дереву

(твердый сплав)

RO Ferăstrău circular

cu dinți din wolfram pt. Lemn

210x30x3.2x2.2HW

60T



$n_{max}$  8 000 obr/min





**Drills**  
Wiertła



173-178

|  |     |
|--|-----|
| Twist drill bits HSS & sets                          | 173 |
| Wiertła do metalu HSS i zestawy                      | 173 |
| Twist drill bits HSS-E Co                            | 174 |
| Wiertła do metalu HSS-E Co                           | 174 |
| SDS masonry drill bits X-TIP                         | 174 |
| Wiertła do betonu SDS, z grotem krzyżowym            | 174 |
| SDS masonry drill bits                               | 175 |
| Wiertła do betonu SDS                                | 175 |
| Masonry drill bits with cylindrical shank & sets     | 175 |
| Wiertła do betonu z uchwytem cylindrycznym i zestawy | 175 |
| Flat wood drill bits & sets                          | 176 |
| Wiertła łopatkowe do drewna i zestawy                | 176 |
| Spur wood drill bits                                 | 177 |
| Wiertła do drewna spiralne                           | 177 |
| Auger wood drill bits & sets                         | 177 |
| Świdry do drewna i zestawy                           | 177 |
| Drills for glass                                     | 178 |
| Wiertła do szkła                                     | 178 |

**Adjustable hand reamers**  
Rozwiertaki nastawne



178

**SDS Chisels**  
Przecinaki i dłuta SDS



178

**Hollow drill sets**  
Wiertła koronowe do betonu



179

**Bi-metal hole saws**  
Otwornice bimetalowe



179-180

|                                  |     |
|----------------------------------|-----|
| Bi-metal hole saws               | 179 |
| Otwornice bimetalowe             | 179 |
| Arbors for hole saws             | 179 |
| Uchwyty do otwornic bimetalowych | 179 |
| Hole saw kits                    | 179 |
| Zestawy otwornic bimetalowych    | 179 |

**Taps & dies**  
Narzędzia do gwintowania



181-183

|  |     |
|--|-----|
| Hand taps & sets                       | 181 |
| Gwintowniki i zestawy                  | 181 |
| Circular dies                          | 182 |
| Narzynki                               | 182 |
| Tap wrenches & die holders             | 182 |
| Pokrętła do gwintowników i narzynek    | 182 |
| Thread repair sets & accessories       | 183 |
| Zestawy do naprawy gwintów i akcesoria | 183 |

**Router bits**  
Frezy do drewna



184

**Diamond tools**  
Narzędzia diamentowe



185-186

|  |     |
|--|-----|
| Diamond blades for cutting construction materials    | 185 |
| Tarcze diamentowe do cięcia materiałów budowlanych   | 185 |
| Diamond blades for cutting concrete                  | 185 |
| Tarcze diamentowe do cięcia betonu                   | 185 |
| Diamond blades for cutting stone                     | 185 |
| Tarcze diamentowe do cięcia kamienia                 | 185 |
| Diamond blades for cutting ceramic tiles             | 186 |
| Tarcze diamentowe do cięcia płytek ceramicznych      | 186 |
| Diamond blades for cutting asphalt                   | 186 |
| Tarcze diamentowe do cięcia asfaltu                  | 186 |
| Diamond grinding cup wheels                          | 186 |
| Diamentowe talerze szlifierskie do betonu i kamienia | 186 |
| Diamond core drill bits                              | 186 |
| Diamentowe wiertła koronowe                          | 186 |

**Tungsten carbide tipped tools**  
Narzędzia z ostrzem z węgliku wolframu



187

|                                     |     |
|-------------------------------------|-----|
| Tungsten carbide saws for wood      | 187 |
| Tarcze z węglikiem do drewna        | 187 |
| Tungsten carbide saws for aluminium | 187 |
| Tarcze z węglikiem do aluminium     | 187 |

**Cutting & grinding discs**  
Tarcze do cięcia i szlifowania



187-188

|                                    |     |
|------------------------------------|-----|
| Stainless steel cutting discs      | 187 |
| Tarcze do cięcia stali nierdzewnej | 187 |
| Metal cutting discs                | 187 |
| Tarcze do cięcia metalu            | 187 |
| Metal grinding discs               | 188 |
| Tarcze do szlifowania metalu       | 188 |
| Stone cutting discs                | 188 |
| Tarcze do cięcia kamienia          | 188 |
| Stone grinding discs               | 188 |
| Tarcze do szlifowania kamienia     | 188 |



**Shears**  
Nożyce



189-193

|  |     |
|--|-----|
| Heavy duty cable cutters                       | 189 |
| Nożyce do cięcia przewodów                     | 189 |
| Tin snips                                      | 189 |
| Nożyce do blachy                               | 189 |
| Steel strap cutters                            | 192 |
| Nożyce do cięcia taśm stalowych                | 192 |
| Bolt cutters                                   | 192 |
| Nożyce do prętów                               | 192 |
| Hydraulic cutters & accessories                | 193 |
| Nożyce z siłownikiem hydraulicznym i akcesoria | 193 |
| Cable cutters                                  | 193 |
| Nożyce do kabli                                | 193 |
| Multifunctional scissors                       | 193 |
| Nożyce wielofunkcyjne                          | 193 |



|  |   |   |                                 |  |  |
|--|---|---|---------------------------------|--|--|
| <b>Saws &amp; blades</b>                               |   |    | <b>Piły i brzeszczoty</b>       |  |  |
|  |   |   | 194-200                         |  |  |
| <b>Hand saws</b>                                       |   |   |                                 |  |  |
|  | Piły do drewna.....                                       |   | 194                             |  |  |
| <b>Bow saws</b>  |   |   |                                 |  |  |
|  | Piły kabłąkowe.....                                       |   | 194                             |  |  |
| <b>Blades</b>  |   |   |                                 |  |  |
|  | Brzeszczoty.....  |   | 195                             |  |  |
| <b>Hacksaw frames</b>                                  |   |   |                                 |  |  |
|  | Piły do metalu.....                                       |   | 195                             |  |  |
| <b>Hacksaw frame blades</b>                            |   |   |                                 |  |  |
|  | Brzeszczoty do metalu.....                                |   | 195                             |  |  |
| <b>Jig saw blades</b>                                  |   |   |                                 |  |  |
|  | Brzeszczoty do wyrzynarek.....                            |   | 196                             |  |  |
| <b>Accessories for multi-purpose oscillating tools</b> |   |   |                                 |  |  |
|  | Akcesoria do wielofunkcyjnych narzędzi oscylacyjnych..... |   | 198                             |  |  |
| <b>Brushes, knives &amp; files</b>                     |   |    | <b>Szczotki, noże i pilniki</b> |  |  |
|  |   |   | 201-215                         |  |  |
| <b>Wire brushes &amp; sets</b>                         |   |   |                                 |  |  |
|  | Szczotki druciane i zestawy.....                          |   | 201                             |  |  |
| <b>Cup brushes</b>                                     |   |   |                                 |  |  |
|  | Szczotki tarczowe.....                                    |   | 203                             |  |  |
| <b>Knives &amp; blades</b>                             |   |   |                                 |  |  |
|  | Noże i ostrza.....  |   | 204                             |  |  |
| <b>Scissors</b>  |   |   |                                 |  |  |
|  | Nożyczki.....   |   | 207                             |  |  |
| <b>Profile gauges</b>                                  |   |   |                                 |  |  |
|  | Wzorniki profili.....                                     |   | 208                             |  |  |
| <b>Punch sets</b>                                      |   |   |                                 |  |  |
|  | Przebijaki do skóry.....                                  |   | 208                             |  |  |
| <b>Cutters</b>   |   |   |                                 |  |  |
|  | Obcinaki.....   |   | 209                             |  |  |
| <b>Window scrapers</b>                                 |   |   |                                 |  |  |
|  | Skrobaki do szyb.....                                     |   | 211                             |  |  |
| <b>Scrapers</b>  |   |   |                                 |  |  |
|  | Cykliny metalowe.....                                     |   | 211                             |  |  |
| <b>Steel files &amp; sets</b>                          |   |   |                                 |  |  |
|  | Pilniki do metalu i zestawy.....                          |   | 212                             |  |  |
| <b>Needle file sets</b>                                |   |   |                                 |  |  |
|  | Zestawy pilników iglaków.....                             |   | 213                             |  |  |
| <b>Diamond needle files &amp; sets</b>                 |   |   |                                 |  |  |
|  | Pilniki iglaki diamentowe i zestawy.....                  |   | 213                             |  |  |
| <b>Rasps &amp; sets</b>                                |   |   |                                 |  |  |
|  | Tarniki do drewna i zestawy.....                          |   | 215                             |  |  |
| <b>Abrasive products</b>                               |   |  | <b>Artykuły ścierne</b>         |  |  |
|  |   |   | 216-221                         |  |  |
| <b>Sand papers</b>                                     |   |   |                                 |  |  |
|  | Papiery ścierne.....                                      |   | 216                             |  |  |
| <b>Waterproof sand papers</b>                          |   |   |                                 |  |  |
|  | Papiery ścierne wodoodporne.....                          |   | 217                             |  |  |
| <b>Abrasive clothes</b>                                |   |   |                                 |  |  |
|  | Płótna ścierne.....                                       |   | 218                             |  |  |
| <b>No end abrasive bands</b>                           |   |   |                                 |  |  |
|  | Taśmy ścierne bezkońcowe.....                             |   | 218                             |  |  |
| <b>Flap discs</b>                                      |   |   |                                 |  |  |
|  | Ściernice listkowe.....                                   |   | 219                             |  |  |
| <b>Abrasive sheets and discs</b>                       |   |   |                                 |  |  |
|  | Arkusze i krążki ścierne.....                             |   | 221                             |  |  |



GB Twist drill HSS  
D Metallspiralbohrer HSS  
PL Wiertło do metalu HSS  
RUS Сверло по металлу HSS  
CZ Vrták na kov HSS  
H Fúrószár fémhez HSS  
RO Burghiu pt. metal HSS

F Foret métal HSS  
I Punta per metallo HSS  
E Broca para metal HSS  
CN 轧制麻花钻

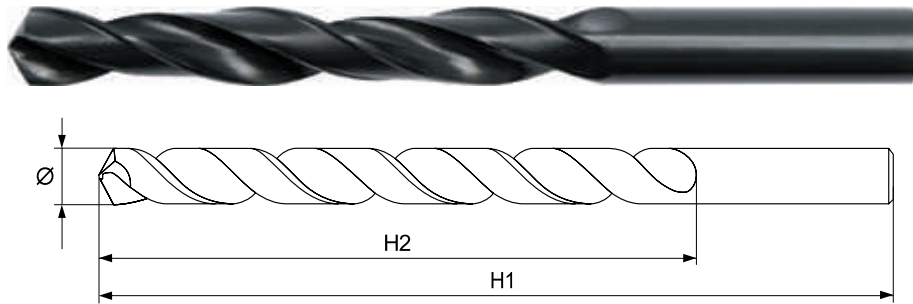
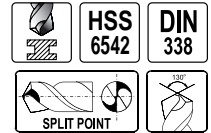

- application: industry
- for precise drilling in steels, cast steels, non-ferrous metals, plastics
- przeznaczenie: przemysł
- do precyzyjnych wierceń w stalach, żeliwach, metalach nieżelaznych, tworzywach sztucznych



| YATO    | Ø (mm) | H1 (mm) | H2 (mm) | R.P.M.max. | PCS packing | Box    |
|---------|--------|---------|---------|------------|-------------|--------|
| YT-4430 | 1.0    | 34      | 12      | 3800       | 10          | 80/320 |
| YT-4431 | 1.5    | 43      | 20      | 3800       | 10          | 80/320 |
| YT-4432 | 2.0    | 49      | 24      | 4000       | 10          | 80/320 |
| YT-4433 | 2.5    | 57      | 30      | 3200       | 10          | 80/320 |
| YT-4434 | 2.8    | 61      | 33      | 2800       | 10          | 80/320 |
| YT-4435 | 3.0    | 61      | 33      | 2600       | 10          | 80/320 |
| YT-4436 | 3.2    | 65      | 36      | 2500       | 10          | 80/320 |
| YT-4437 | 3.5    | 70      | 39      | 2300       | 10          | 80/320 |
| YT-4438 | 4.0    | 75      | 43      | 2000       | 10          | 80/320 |
| YT-4439 | 4.2    | 75      | 43      | 1900       | 10          | 20/80  |
| YT-4440 | 4.5    | 80      | 47      | 1800       | 10          | 20/80  |
| YT-4441 | 4.8    | 86      | 52      | 1600       | 10          | 20/80  |
| YT-4442 | 5.0    | 86      | 52      | 1600       | 10          | 20/80  |
| YT-4443 | 5.2    | 86      | 52      | 1500       | 10          | 20/80  |
| YT-4444 | 5.5    | 93      | 57      | 1500       | 10          | 20/80  |

| YATO    | Ø (mm) | H1 (mm) | H2 (mm) | R.P.M.max. | PCS packing | Box   |
|---------|--------|---------|---------|------------|-------------|-------|
| YT-4445 | 6.0    | 93      | 57      | 1300       | 10          | 20/80 |
| YT-4446 | 6.5    | 101     | 63      | 1200       | 10          | 10/40 |
| YT-4447 | 7.0    | 109     | 69      | 1100       | 10          | 10/40 |
| YT-4448 | 7.5    | 109     | 69      | 1100       | 10          | 10/40 |
| YT-4449 | 8.0    | 117     | 75      | 1000       | 10          | 10/40 |
| YT-4450 | 8.5    | 117     | 75      | 900        | 5           | 10/40 |
| YT-4451 | 9.0    | 125     | 81      | 900        | 5           | 10/40 |
| YT-4452 | 9.5    | 125     | 81      | 800        | 5           | 10/40 |
| YT-4453 | 10.0   | 133     | 87      | 800        | 5           | 10/40 |
| YT-4454 | 10.5   | 133     | 87      | 800        | 3           | 10/40 |
| YT-4455 | 11.0   | 142     | 94      | 700        | 3           | 10/40 |
| YT-4456 | 12.0   | 151     | 101     | 700        | 3           | 10/40 |
| YT-4457 | 12.5   | 151     | 101     | 600        | 3           | 10/40 |
| YT-4458 | 13.0   | 151     | 101     | 600        | 3           | 10/40 |

GB Twist drill set  
D Metallspiralbohrersatz  
PL Komplet wiertło do metalu  
RUS Набор сверл по металлу  
CZ Souprava vrtáků na kov  
H Fúrószárkészlet fémhez

RO Set de burghie pt. metal  
F Set des forets métal HSS  
I Set punte per metallo  
E Broca para metal  
CN 轧制麻花钻组套

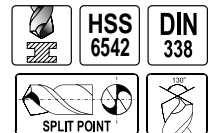

6  
PCS

Ø mm  
2-8



10  
PCS

Ø mm  
1-10



19  
PCS

Ø mm  
1-10



| YATO    | Ø (mm)           | Box   |
|---------|------------------|-------|
| YT-4460 | 2; 3; 4; 5; 6; 8 | 15/60 |

| YATO    | Ø (mm)                        | Box   |
|---------|-------------------------------|-------|
| YT-4461 | 1; 2; 3; 4; 5; 6; 7; 8; 9; 10 | 20/40 |

| YATO    | Ø (mm)   | Box   |
|---------|--|-------|
| YT-4462 | 1.0; 1.5; 2.0; 2.5; 3.0; 3.5; 4.0; 4.5; 5.0; 5.5; 6.0; 6.5; 7.0; 7.5; 8.0; 8.5; 9.0; 9.5; 10.0 | 15/30 |

GB Twist drill HSS-COBALT  
 D Metallspiralbohrer HSS-COBALT  
 PL Wiertło do metalu HSS-COBALT  
 RUS Сверло по металлу HSS-COBALT  
 CZ Vrták na kov HSS-COBALT

H Fűrészár fémhez HSS-COBALT  
 RO Burghiu pt. metal HSS-COBALT  
 F Foret métal HSS-COBALT  
 I Punta per metallo HSS-COBALT  
 E Broca para metal HSS-COBALT  
 CN 全磨制含钴麻花钻

|                |   |                                     |
|----------------|---|-------------------------------------|
| <b>DIN 338</b> | <b>HSS-E Co HS6-5-2-5</b><br>(PN-EN ISO 4957:2002(U)) | <b>Rm</b><br>>900 N/mm <sup>2</sup> |
|                |   |                                     |
|                | <b>SPLIT POINT</b>                                    |                                     |

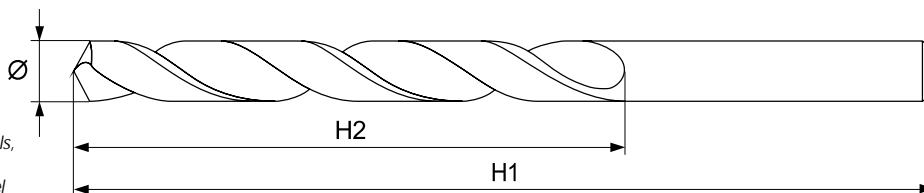

- application: industry
- for precise drilling in hard steels, non-ferrous metals, plastics, stainless steel and acid resistant steel
- resistant to high temperatures
- przeznaczenie: przemysł
- do precyzyjnych wierceń w trudnych materiałach, np. stalach szlachetnych, metalach kolorowych, tworzywach, stalach nierdzewnych i kwasoodpornych
- odporna na działanie wysokiej temperatury



BLISTER CARD

| YATO    | Ø (mm) | H1 (mm) | H2 (mm) | PCS packing |         |
|---------|--------|---------|---------|-------------|---------|
| YT-4020 | 2.0    | 49      | 24      | 2           | 125/500 |
| YT-4025 | 2.5    | 57      | 30      | 2           | 125/500 |
| YT-4030 | 3.0    | 61      | 33      | 2           | 125/500 |
| YT-4032 | 3.2    | 65      | 36      | 1           | 100/400 |
| YT-4035 | 3.5    | 70      | 39      | 1           | 100/400 |
| YT-4040 | 4.0    | 75      | 43      | 1           | 100/400 |
| YT-4042 | 4.2    | 75      | 43      | 1           | 100/400 |
| YT-4045 | 4.5    | 80      | 47      | 1           | 100/400 |

| YATO    | Ø (mm) | H1 (mm) | H2 (mm) | PCS packing |         |
|---------|--------|---------|---------|-------------|---------|
| YT-4048 | 4.8    | 86      | 52      | 1           | 100/400 |
| YT-4050 | 5.0    | 86      | 52      | 1           | 100/400 |
| YT-4052 | 5.2    | 86      | 52      | 1           | 100/400 |
| YT-4055 | 5.5    | 93      | 57      | 1           | 100/400 |
| YT-4060 | 6.0    | 93      | 57      | 1           | 100/400 |
| YT-4065 | 6.5    | 101     | 63      | 1           | 75/300  |
| YT-4070 | 7.0    | 109     | 69      | 1           | 75/300  |
| YT-4075 | 7.5    | 109     | 69      | 1           | 75/300  |

| YATO    | Ø (mm) | H1 (mm) | H2 (mm) | PCS packing |        |
|---------|--------|---------|---------|-------------|--------|
| YT-4080 | 8.0    | 117     | 75      | 1           | 75/300 |
| YT-4085 | 8.5    | 117     | 75      | 1           | 75/300 |
| YT-4090 | 9.0    | 125     | 81      | 1           | 75/300 |
| YT-4100 | 10.0   | 133     | 87      | 1           | 75/300 |
| YT-4110 | 11.0   | 142     | 94      | 1           | 75/300 |
| YT-4120 | 12.0   | 151     | 101     | 1           | 75/300 |
| YT-4140 | 14.0   | 160     | 108     | 1           | 25/100 |
| YT-4160 | 16.0   | 178     | 120     | 1           | 25/100 |

GB Masonry drill bit X-TIP  
 D Betonspiralbohrer X-TIP  
 PL Wiertło do betonu X-TIP  
 RUS Сверло по бетону X-TIP  
 CZ Vrták na beton X-TIP  
 H Fűrészár betonhoz X-TIP

RO Burghiu pt. beton X-TIP  
 F Foret béton à pointe en croix  
 I Punta per cemento X-TIP  
 E Broca para hormigón X-TIP  
 CN 十字头电锤钻

|  |                 |                     |
|--|-----------------|---------------------|
|  | <b>SDS PLUS</b> | <b>X-TIP YG-11C</b> |
|--|-----------------|---------------------|

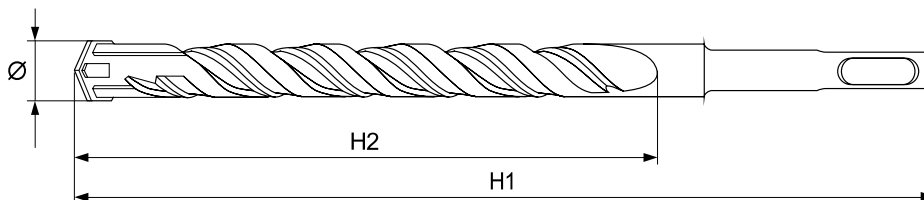

PLASTIC TUBE & PLASTIC HANGER

| YATO    | Ø (mm) | H1 (mm) | H2 (mm) | PCS packing |     |
|---------|--------|---------|---------|-------------|-----|
| YT-4200 | 5      | 110     | 45      | 10          | 300 |
| YT-4201 | 6      | 110     | 45      | 10          | 300 |
| YT-4202 | 6      | 160     | 95      | 10          | 200 |
| YT-4203 | 6      | 210     | 135     | 10          | 150 |
| YT-4204 | 8      | 110     | 45      | 10          | 300 |
| YT-4205 | 8      | 160     | 95      | 10          | 200 |
| YT-4206 | 8      | 210     | 140     | 10          | 150 |
| YT-4207 | 8      | 460     | 370     | 10          | 50  |
| YT-4208 | 8      | 600     | 500     | 10          | 50  |
| YT-4209 | 10     | 160     | 95      | 10          | 150 |
| YT-4210 | 10     | 210     | 140     | 10          | 150 |

| YATO    | Ø (mm) | H1 (mm) | H2 (mm) | PCS packing |     |
|---------|--------|---------|---------|-------------|-----|
| YT-4211 | 10     | 300     | 220     | 10          | 100 |
| YT-4212 | 10     | 460     | 370     | 10          | 50  |
| YT-4213 | 10     | 600     | 500     | 10          | 50  |
| YT-4214 | 12     | 160     | 95      | 10          | 150 |
| YT-4215 | 12     | 260     | 185     | 10          | 100 |
| YT-4216 | 12     | 460     | 360     | 10          | 50  |
| YT-4217 | 12     | 600     | 490     | 10          | 40  |
| YT-4218 | 14     | 260     | 180     | 10          | 80  |
| YT-4219 | 14     | 460     | 360     | 10          | 40  |
| YT-4220 | 16     | 200     | 125     | 10          | 60  |
| YT-4221 | 16     | 460     | 360     | 10          | 20  |

| YATO    | Ø (mm) | H1 (mm) | H2 (mm) | PCS packing |    |
|---------|--------|---------|---------|-------------|----|
| YT-4222 | 16     | 600     | 490     | 10          | 20 |
| YT-4223 | 18     | 460     | 360     | 10          | 20 |
| YT-4224 | 18     | 600     | 490     | 10          | 20 |
| YT-4225 | 20     | 460     | 360     | 5           | 20 |
| YT-4226 | 20     | 600     | 490     | 5           | 20 |
| YT-4227 | 22     | 460     | 360     | 5           | 20 |
| YT-4228 | 22     | 600     | 490     | 5           | 20 |
| YT-4229 | 25     | 460     | 360     | 5           | 20 |
| YT-4230 | 25     | 600     | 490     | 5           | 10 |



GB Masonry drill bit  
D Betonspiralbohrer  
PL Wiertło do betonu  
RUS Сверло по бетону

CZ Vrták na beton  
H Fúrószár betonhoz  
RO Burghiu pt. beton  
F Foret béton

I Punta per cemento  
E Broca para hormigón  
CN 建工钻



SDS PLUS

3 POINT TIP DK-30

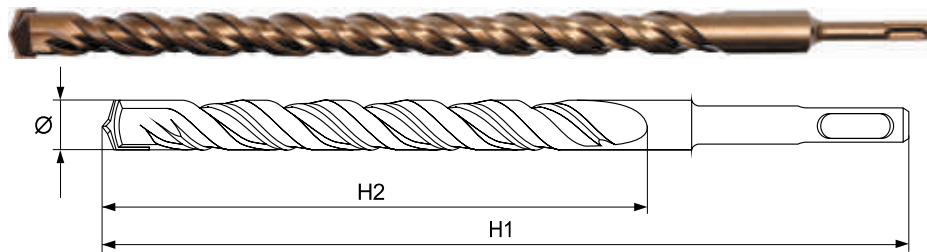

PLASTIC TUBE & PLASTIC HANGER

| YATO    | Ø (mm) | H1 (mm) | H2 (mm) | PCS packing: |     |
|---------|--------|---------|---------|--------------|-----|
| YT-4161 | 5      | 110     | 45      | 10           | 300 |
| YT-4162 | 6      | 110     | 45      | 10           | 300 |
| YT-4163 | 6      | 160     | 95      | 10           | 200 |
| YT-4164 | 6      | 210     | 140     | 10           | 150 |
| YT-4165 | 8      | 110     | 45      | 10           | 300 |
| YT-4166 | 8      | 160     | 90      | 10           | 200 |
| YT-4167 | 8      | 210     | 140     | 10           | 150 |
| YT-4168 | 8      | 460     | 370     | 10           | 50  |
| YT-4169 | 8      | 600     | 500     | 10           | 50  |
| YT-4170 | 10     | 160     | 95      | 10           | 150 |
| YT-4171 | 10     | 210     | 140     | 10           | 150 |

| YATO    | Ø (mm) | H1 (mm) | H2 (mm) | PCS packing: |     |
|---------|--------|---------|---------|--------------|-----|
| YT-4172 | 10     | 300     | 220     | 10           | 100 |
| YT-4173 | 10     | 460     | 370     | 10           | 50  |
| YT-4174 | 10     | 600     | 500     | 10           | 50  |
| YT-4175 | 12     | 160     | 85      | 10           | 150 |
| YT-4176 | 12     | 260     | 180     | 10           | 100 |
| YT-4177 | 12     | 460     | 360     | 10           | 50  |
| YT-4178 | 12     | 600     | 490     | 10           | 40  |
| YT-4179 | 14     | 260     | 190     | 10           | 80  |
| YT-4180 | 14     | 460     | 360     | 10           | 40  |
| YT-4181 | 16     | 200     | 125     | 10           | 60  |
| YT-4182 | 16     | 300     | 220     | 10           | 50  |

| YATO    | Ø (mm) | H1 (mm) | H2 (mm) | PCS packing: |    |
|---------|--------|---------|---------|--------------|----|
| YT-4183 | 16     | 460     | 360     | 10           | 20 |
| YT-4184 | 16     | 600     | 490     | 10           | 20 |
| YT-4185 | 18     | 460     | 360     | 10           | 20 |
| YT-4186 | 18     | 600     | 490     | 10           | 20 |
| YT-4187 | 20     | 460     | 360     | 5            | 20 |
| YT-4188 | 20     | 600     | 490     | 5            | 20 |
| YT-4189 | 22     | 460     | 360     | 5            | 20 |
| YT-4190 | 22     | 600     | 490     | 5            | 20 |
| YT-4191 | 25     | 460     | 360     | 5            | 20 |
| YT-4192 | 25     | 600     | 490     | 5            | 10 |

GB Masonry drill bit  
D Betonspiralbohrer  
PL Wiertło do betonu  
RUS Сверло по бетону  
CZ Vrták na beton  
H Fúrószár betonhoz

RO Burghiu pt. beton  
F Foret béton  
I Punta per cemento  
E Broca para hormigón  
CN 建工钻



YG-8C  
HRC 89-90



40CR  
HRC 47

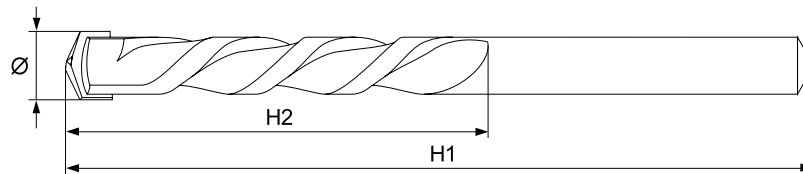

BLISTER CARD

| YATO    | Ø (mm) | H1 (mm) | H2 (mm) |         |
|---------|--------|---------|---------|---------|
| YT-4361 | 4      | 70      | 35      | 100/400 |
| YT-4362 | 5      | 90      | 50      | 100/400 |
| YT-4363 | 6      | 100     | 60      | 100/400 |
| YT-4364 | 6      | 150     | 100     | 100/400 |
| YT-4367 | 7      | 100     | 60      | 75/300  |
| YT-4369 | 8      | 120     | 80      | 75/300  |
| YT-4370 | 8      | 200     | 140     | 50/150  |

| YATO    | Ø (mm) | H1 (mm) | H2 (mm) |        |
|---------|--------|---------|---------|--------|
| YT-4373 | 9      | 120     | 80      | 75/300 |
| YT-4375 | 10     | 120     | 80      | 75/300 |
| YT-4376 | 10     | 200     | 140     | 50/150 |
| YT-4379 | 12     | 150     | 100     | 50/150 |
| YT-4380 | 12     | 200     | 140     | 50/150 |
| YT-4383 | 14     | 180     | 120     | 25/100 |
| YT-4385 | 16     | 180     | 120     | 25/100 |

GB Masonry drill bit set  
D Betonspiralbohrersatz  
PL Komplet wiertło do betonu  
RUS Сверла по бетону в наборе  
CZ Souprava vrtáků do betonu  
H Fúrószárkészlet betonhoz  
RO Set de burghie pt. beton  
F Set des forets béton  
I Set punte per cemento  
E Brocas para hormigón  
CN 建工钻组套



7  
PCS



YG-8C  
HRC 89-90



40CR  
HRC 47

PLASTIC HANGING BOX

| YATO    | Ø (mm)                |       |
|---------|-----------------------|-------|
| YT-4390 | 4; 5; 6; 8; 9; 10; 12 | 10/80 |

GB Flat wood drill bit  
D Schaufelbohrer  
PL Wiertło łopatkowe do drewna  
RUS Перовые сверло

CZ Plochý vrták  
H Homlokmarós fűrő  
RO Burghiu plate  
F Mèche à bois plate

I Punta per legno piatta  
E Broca de aletas  
CN 木工扁钻

DOUBLE BLISTER



1/4" (6.3mm)

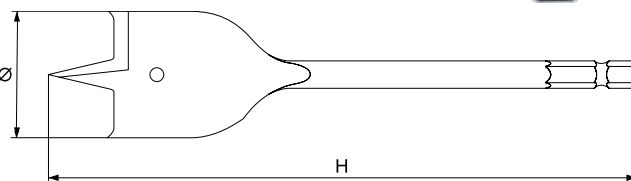

| YATO    | Ø (mm) | H (mm) |        |
|---------|--------|--------|--------|
| YT-3236 | 6      | 152    | 50/400 |
| YT-3237 | 8      | 152    | 50/400 |
| YT-3238 | 10     | 152    | 50/300 |
| YT-3239 | 12     | 152    | 50/300 |
| YT-3240 | 13     | 152    | 50/300 |
| YT-3241 | 14     | 152    | 50/300 |
| YT-3242 | 16     | 152    | 50/300 |
| YT-3243 | 18     | 152    | 50/300 |
| YT-3244 | 20     | 152    | 50/300 |
| YT-3245 | 22     | 152    | 50/300 |

| YATO    | Ø (mm) | H (mm) |        |
|---------|--------|--------|--------|
| YT-3246 | 24     | 152    | 50/300 |
| YT-3247 | 25     | 152    | 50/300 |
| YT-3248 | 26     | 152    | 50/300 |
| YT-3249 | 28     | 152    | 50/300 |
| YT-3250 | 30     | 152    | 50/200 |
| YT-3251 | 32     | 152    | 50/200 |
| YT-3252 | 34     | 152    | 50/200 |
| YT-3253 | 35     | 152    | 50/200 |
| YT-3254 | 38     | 152    | 50/200 |
| YT-3255 | 40     | 152    | 50/200 |

GB Extension for flat wood drill bits  
D Verlängerung für Schaufelbohrer  
PL Przedłużka do wiertel łopatkowych  
RUS Удлинитель для перовых сверл  
CZ Nástavec pro ploché vrtáky  
H Hosszabbító homlokmarós fűrőkhöz  
RO Prelungitor pt. burghie plate  
F Rallonge pour mèches à bois  
I Prolunga per punta fresatrice  
E Extensión para brocas de aletas  
CN 木工扁钻延长杆

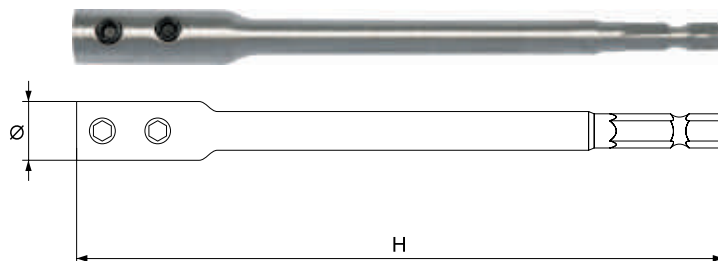

1/4" (6.3mm)

DOUBLE BLISTER

| YATO    | Ø (mm) | H (mm) |        |
|---------|--------|--------|--------|
| YT-3256 | 12.2   | 150    | 60/120 |
| YT-3257 | 13.5   | 300    | 30/60  |

GB Flat wood drill bit set  
D Schaufelbohrersatz  
PL Zestaw wiertel łopatkowych  
RUS Набор перовых сверл  
CZ Sada plochých vrtáků  
H Homlokmarós fűrő készlet

RO Set burghie plate  
F Set de mèche à bois  
I Set di punte per legno piatta  
E Juego de brocas de aletas  
CN 木工扁钻组套

6 PCS

1/4" (6.3mm)

GB Flat wood drill bit set  
D Schaufelbohrersatz  
PL Zestaw wiertel łopatkowych  
RUS Набор перовых сверл  
CZ Sada plochých vrtáků  
H Homlokmarós fűrő készlet

RO Set burghie plate  
F Set de mèche à bois  
I Set di punte per legno piatta  
E Juego de brocas de aletas  
CN 木工扁钻组套

8 PCS

1/4" (6.3mm)



POUCH

| YATO    | Ø (mm)                 | H (mm) |       |
|---------|------------------------|--------|-------|
| YT-3258 | 10; 12; 16; 18; 20; 25 | 152    | 25/50 |



PLASTIC CASE & DOUBLE BLISTER

| YATO    | Ø (mm)                         | H (mm) |      |
|---------|--------------------------------|--------|------|
| YT-3259 | 12; 16; 18; 20; 22; 25; 28; 32 | 152    | 5/20 |



GB Spur wood drill bit  
D Spiralbohrer für Holz  
PL Wiertło do drewna spiralne

RUS Спиральное сверло по дереву  
CZ Vrták do dřeva spirálový  
H Csigafúró fához

RO Burghiu spirală pt. lemn  
F Méches hélicoïdales à bois  
I Punta per legno spirale

E Barrena para madera espiral  
CN 木工钻

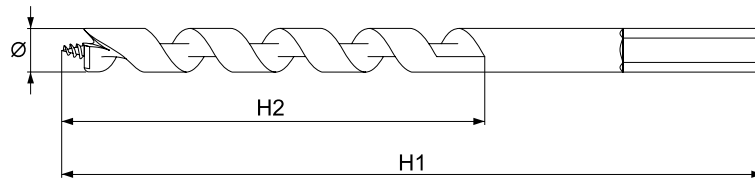

DOUBLE BLISTER

| YATO    | Ø (mm) | H1 (mm) | H2 (mm) | Box    |
|---------|--------|---------|---------|--------|
| YT-4350 | 3      | 60      | 35      | 30/300 |
| YT-4351 | 4      | 75      | 44      | 30/300 |
| YT-4352 | 5      | 85      | 52      | 30/300 |
| YT-4353 | 6      | 90      | 57      | 30/300 |
| YT-4354 | 7      | 100     | 67      | 30/300 |

| YATO    | Ø (mm) | H1 (mm) | H2 (mm) | Box    |
|---------|--------|---------|---------|--------|
| YT-4355 | 8      | 110     | 75      | 30/300 |
| YT-4356 | 10     | 120     | 77      | 30/300 |
| YT-4357 | 12     | 150     | 97      | 15/120 |
| YT-4358 | 13     | 150     | 102     | 15/120 |
| YT-4359 | 16     | 180     | 120     | 15/120 |

GB Auger wood drill bit  
D Holzbohrer  
PL Świdroł do drewna

RUS Бур по дереву  
CZ Vrták do dřeva hadovitý  
H Fafúró

RO Burghiu elicoidal pt. lemn  
F Foret spirale à bois  
I Punta a torciglione per legno

E Barrena para madera  
CN 螺旋木工钻

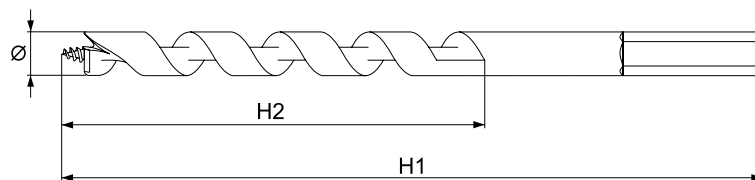

DOUBLE BLISTER

| YATO    | Ø (mm) | H1 (mm) | H1 (mm) | Box    |
|---------|--------|---------|---------|--------|
| YT-3261 | 6      | 191     | 121     | 60/360 |
| YT-3262 | 8      | 191     | 121     | 70/280 |
| YT-3263 | 8      | 400     | 310     | 60/120 |
| YT-3264 | 10     | 191     | 121     | 50/200 |
| YT-3265 | 10     | 400     | 310     | 50/100 |
| YT-3266 | 12     | 191     | 121     | 50/150 |
| YT-3267 | 12     | 400     | 310     | 20/60  |
| YT-3268 | 13     | 191     | 121     | 50/100 |
| YT-3269 | 13     | 400     | 310     | 20/60  |
| YT-3270 | 14     | 191     | 121     | 50/100 |
| YT-3271 | 14     | 400     | 310     | 20/60  |
| YT-3272 | 16     | 191     | 121     | 50/100 |
| YT-3273 | 16     | 400     | 310     | 20/40  |

| YATO    | Ø (mm) | H1 (mm) | H1 (mm) | Box   |
|---------|--------|---------|---------|-------|
| YT-3274 | 18     | 215     | 142     | 40/80 |
| YT-3275 | 18     | 400     | 310     | 20/40 |
| YT-3276 | 20     | 215     | 145     | 20/60 |
| YT-3277 | 20     | 400     | 310     | 20/40 |
| YT-3278 | 22     | 215     | 145     | 20/60 |
| YT-3279 | 22     | 400     | 310     | 10/30 |
| YT-3280 | 24     | 215     | 145     | 20/60 |
| YT-3281 | 24     | 400     | 310     | 6/30  |
| YT-3282 | 25     | 215     | 145     | 20/40 |
| YT-3283 | 25     | 400     | 310     | 5/25  |
| YT-3284 | 26     | 215     | 145     | 10/40 |
| YT-3285 | 26     | 400     | 310     | 10/20 |
| YT-3286 | 28     | 240     | 145     | 9/36  |

| YATO    | Ø (mm) | H1 (mm) | H1 (mm) | Box   |
|---------|--------|---------|---------|-------|
| YT-3287 | 28     | 400     | 310     | 5/20  |
| YT-3288 | 30     | 240     | 170     | 10/30 |
| YT-3289 | 30     | 400     | 310     | 5/10  |
| YT-3290 | 32     | 240     | 170     | 5/25  |
| YT-3291 | 32     | 400     | 310     | 5/15  |
| YT-3292 | 35     | 240     | 170     | 5/20  |
| YT-3293 | 35     | 400     | 310     | 5/10  |
| YT-3294 | 36     | 240     | 170     | 10/20 |
| YT-3295 | 36     | 400     | 310     | 5/10  |
| YT-3296 | 38     | 240     | 170     | 5/15  |
| YT-3297 | 40     | 240     | 170     | 5/15  |

GB Auger wood drill bit set  
D Holzbohrersatz  
PL Zestaw świdrów do drewna  
RUS Набор буров по дереву  
CZ Sada hadovitých vrtáků do dřeva  
H Fafúró keszlet  
RO Set de burghie elicoidale pt. lemn  
F Set de forets spirales à bois  
I Set di punte a torciglione  
E Juego de barrenas para madera  
CN 螺旋木工钻组套



WOOD CASE & COLOR BOX



| 6 PCS | 13mm | YATO    | Ø (mm)                 | H (mm) | Box |
|-------|------|---------|------------------------|--------|-----|
|       |      | YT-3299 | 10; 12; 14; 16; 18; 20 | 460    | 8   |

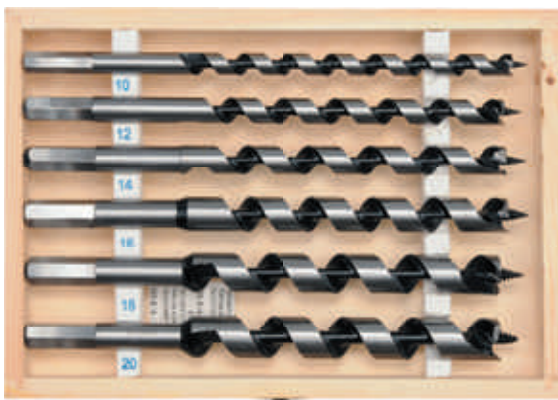

| 6 PCS | 13mm | YATO    | Ø (mm)                 | H (mm) | Box |
|-------|------|---------|------------------------|--------|-----|
|       |      | YT-3298 | 10; 12; 14; 16; 18; 20 | 230    | 15  |

| 6 PCS | SDS PLUS | YATO    | Ø (mm)                 | H (mm) | Box |
|-------|----------|---------|------------------------|--------|-----|
|       |          | YT-3300 | 10; 12; 14; 16; 18; 20 | 200    | 20  |

- GB Drill for glass F Foret à verre  
 D Bohrer für Glas et à ceramique  
 PL Wiertło do szkła I Punta per vetro  
 RUS Сверло по стеклу E Broca para vidrio  
 CZ Vrták do skla CN 玻璃钻  
 H Üvegfúró  
 RO Burghiu pt. sticlă



YG6X HRA 90

SLIDING CARD

| YATO    | Ø (mm) |         |
|---------|--------|---------|
| YT-3725 | 4      | 100/400 |
| YT-3726 | 6      | 100/400 |

| YATO    | Ø (mm) |         |
|---------|--------|---------|
| YT-3727 | 8      | 100/400 |
| YT-3728 | 10     | 50/200  |

- GB Adjustable hand reamer  
 D Verstellbare Reibahle  
 PL Rozwiertak nastawny  
 RUS Регулируемая развертка  
 CZ Nastavitelný výstružník  
 H Allítható dorzsár  
 RO Alezor reglabil  
 F Alesoir à main réglable  
 I Alesatore regolabile  
 E Escariador ajustable  
 CN 可调式用手铰刀



HSS 4241

PLASTIC TUBE

| YATO     | working diameter /<br>średnica robocza (mm²) | L (mm) | arbor diameter /<br>średnica trzpienia (mm²) |        |
|----------|--|--------|--|--------|
| YT-28950 | 7.75-8.5                                     | 107    | 4.5  | 50/200 |
| YT-28951 | 8.5-9.25                                     | 112    | 4.5  | 50/200 |
| YT-28952 | 9.25-10                                      | 116    | 5.0  | 50/200 |
| YT-28953 | 10-10.75                                     | 125    | 5.5  | 50/200 |
| YT-28954 | 10.75-11.75                                  | 130    | 6.5  | 50/200 |
| YT-28955 | 11.75-12.75                                  | 135    | 7.5  | 50/150 |
| YT-28956 | 12.75-13.75                                  | 140    | 7.5  | 50/150 |
| YT-28957 | 13.75-15.25                                  | 158    | 8.0  | 20/60  |
| YT-28958 | 15.25-17                                     | 165    | 9.0  | 20/60  |

| YATO     | working diameter /<br>średnica robocza (mm²) | L (mm) | arbor diameter /<br>średnica trzpienia (mm²) |       |
|----------|--|--------|--|-------|
| YT-28959 | 17-19  | 175    | 10.0   | 20/60 |
| YT-28960 | 19-21  | 180    | 11.5   | 20/60 |
| YT-28961 | 21-23  | 193    | 13.5   | 20/40 |
| YT-28962 | 23-26  | 210    | 15.4   | 4/20  |
| YT-28963 | 26-29.5                                      | 245    | 17.0   | 4/20  |
| YT-28964 | 29.5-33.5                                    | 270    | 19.0   | 4/12  |
| YT-28965 | 33.5-38                                      | 310    | 21.0   | 2/10  |
| YT-28966 | 38-44  | 345    | 24.0   | 2/10  |
| YT-28967 | 44-54  | 400    | 30.0   | 5     |

- GB Point chisel SDS+ RUS Зубило SDS+ RO Punctator SDS+ E Cincel puntiagudo SDS+  
 D Spitzmeißel SDS+ CZ Sekáč špičák SDS+ F Percoir SDS+ CN SDS尖凿  
 PL Przecinak SDS+ H Hegyes véső SDS+ I Scalpello SDS+

4x14 x250 mm SDS PLUS CrV



PLASTIC HANGER



| YATO    | L (mm) |      |
|---------|--------|------|
| YT-4720 | 250    | 6/48 |

- GB Flat chisel SDS+ RUS Долото узкое SDS+ RO Punctator pt. adancit SDS+ E Cincel plano estrecho SDS+  
 D Flachmeißel SDS+ CZ Sekáč plochý SDS+ F Ciseau SDS+ CN SDS平凿  
 PL Dłuto wąskie SDS+ H Lapos véső SDS+ I Scalpello punto stretto SDS+

20x14 x250 mm SDS PLUS CrV



PLASTIC HANGER



| YATO    | L (mm) |      |
|---------|--------|------|
| YT-4721 | 250    | 6/48 |

- GB Hollow chisel SDS+ RUS Бороздник SDS+ RO Punctator pt. adancit SDS+ E Cincel acanalado SDS+  
 D Nutenmeißel SDS+ CZ Sekáč drážkovací SDS+ F Burin à entailler SDS+ CN SDS空心凿  
 PL Bruzdownik SDS+ H Horonyvéső SDS+ I Calibro scalpello SDS+

22x18 x250 mm SDS PLUS CrV



PLASTIC HANGER



| YATO    | L (mm) |      |
|---------|--------|------|
| YT-4722 | 250    | 6/48 |

- GB Flat chisel SDS+ RUS Долото плоское SDS+ RO Punctator tip dalta SDS+ E Cincel plano SDS+  
 D Spatmeißel SDS+ CZ Sekáč plochý SDS+ F Ciseau SDS+ CN SDS平凿  
 PL Dłuto płaskie SDS+ H Széles lapos véső SDS+ I Scalpello piatto SDS+

40x14 x250 mm SDS PLUS CrV



PLASTIC HANGER



| YATO    | L (mm) |      |
|---------|--------|------|
| YT-4723 | 250    | 6/48 |



GB Hollow drill set  
D Bohrkronen  
PL Wiertło koronowe do betonu  
RUS Сверла по бетону корончатые

CZ Korunový vrták na zeď  
H Koronafúró falhoz  
RO Burghiu cu coroață pt. beton  
F Trépiéd à mur

I Punta a corona per calcestruzzo  
E Broca widia para muro  
CN 扩孔钻

COLOR BOX



TCT  
YG-11C

Cr50

50mm

M16



HEX  
12mm

SDS  
PLUS

| YATO    | Ø (mm) | TCT |    |
|---------|--------|-----|----|
| YT-4400 | 65     | 6   | 24 |
| YT-4401 | 80     | 8   | 20 |

| YATO    | Ø (mm) | TCT |    |
|---------|--------|-----|----|
| YT-4402 | 65     | 6   | 24 |
| YT-4403 | 80     | 8   | 20 |

GB Bi-metal hole saw  
D Bimetall-Lochsäge  
PL Otwornica bimetalowa  
RUS Ножовка к отверстиям би-металлическая  
CZ Vrtací korunka bimetalová  
H Bi-metál koronafúró  
RO Găurător bi-metalici  
F Scie-trépan bimétal  
I Foro sega utensile da taglio bi-metallo  
E Sierra de marquetería bi-metálica  
CN 双金属孔锯

- application: industry
- to drill holes in stainless steels, cast steels, aluminium, wood, plastics
- cutting depth: 40 mm
- przeznaczenie: przemysł
- do wycinania otworów w stalach nierdzewnych, żelazie, aluminium, drewnie, tworzywach sztucznych
- głębokość cięcia: 40 mm



BI-METAL

HSS M3

ALLOY STEEL

4-6  
TPI

40mm

10

| YATO    | Ø (mm) | thread / gwint |        |
|---------|--------|----------------|--------|
| YT-3303 | 19     | 1/2" (12.5 mm) | 25/100 |
| YT-3304 | 20     | 1/2" (12.5 mm) | 25/100 |
| YT-3306 | 22     | 1/2" (12.5 mm) | 25/100 |
| YT-3308 | 25     | 1/2" (12.5 mm) | 25/100 |
| YT-3311 | 29     | 1/2" (12.5 mm) | 25/100 |
| YT-3313 | 32     | 5/8" (16 mm)   | 25/100 |
| YT-3315 | 35     | 5/8" (16 mm)   | 25/100 |
| YT-3317 | 38     | 5/8" (16 mm)   | 25/100 |
| YT-3318 | 40     | 5/8" (16 mm)   | 25/100 |
| YT-3321 | 44     | 5/8" (16 mm)   | 25/100 |

| YATO    | Ø (mm) | thread / gwint |        |
|---------|--------|----------------|--------|
| YT-3322 | 46     | 5/8" (16 mm)   | 25/100 |
| YT-3323 | 48     | 5/8" (16 mm)   | 25/100 |
| YT-3324 | 51     | 5/8" (16 mm)   | 25/100 |
| YT-3327 | 57     | 5/8" (16 mm)   | 25/50  |
| YT-3329 | 60     | 5/8" (16 mm)   | 25/50  |
| YT-3330 | 64     | 5/8" (16 mm)   | 25/50  |
| YT-3332 | 67     | 5/8" (16 mm)   | 25/50  |
| YT-3333 | 68     | 5/8" (16 mm)   | 25/50  |
| YT-3334 | 70     | 5/8" (16 mm)   | 25/50  |
| YT-3336 | 76     | 5/8" (16 mm)   | 25/50  |

| YATO    | Ø (mm) | thread / gwint |       |
|---------|--------|----------------|-------|
| YT-3338 | 83     | 5/8" (16 mm)   | 25/50 |
| YT-3343 | 95     | 5/8" (16 mm)   | 25/50 |
| YT-3345 | 102    | 5/8" (16 mm)   | 10/20 |
| YT-3346 | 105    | 5/8" (16 mm)   | 10/20 |
| YT-3349 | 114    | 5/8" (16 mm)   | 10/20 |
| YT-3350 | 121    | 5/8" (16 mm)   | 10/20 |
| YT-3351 | 127    | 5/8" (16 mm)   | 10/20 |
| YT-3353 | 140    | 5/8" (16 mm)   | 10/20 |

GB Arbor for hole saw  
D Halterung für Lochsägen  
PL Uchwyt do otwornic  
RUS Рукоятка к ножовке  
CZ Šroubový unášec pro vrtací korunky

H Befogószár a koronafúróhoz  
RO Dispozitiv de antrenare pt. găurător bi-metalici  
F Mandrin aux scies-trépan

I Pergolato per sega  
E Mango para las sierras de marquetería  
CN 孔锯柄轴

HEX

SDS  
PLUS



14-30mm  
1/2" (12.5mm)  
20UNF

DOUBLE  
BLISTER

32-200mm  
5/8" (16mm)  
18UNF

DOUBLE  
BLISTER

| YATO    | SDS+ / HEX        |        |
|---------|-------------------|--------|
| YT-3370 | HEX 7/16" (11 mm) | 25/100 |
| YT-3373 | SDS+              | 25/100 |

| YATO    | SDS+ / HEX        |        |
|---------|-------------------|--------|
| YT-3371 | HEX 7/16" (11 mm) | 25/100 |
| YT-3372 | HEX 7/16" (11 mm) | 25/50  |
| YT-3374 | SDS+              | 25/50  |

GB Pilot drill  
D Pilotbohrer  
PL Wiertło pilot  
RUS Сверло пилот

CZ Středící vrták  
H Központfúró  
RO Burghiu pilot  
F Foret - pilot

I Punta pilota  
E Broca piloto  
CN 导向钻

HSS



| YATO    | Ø (mm) | H (mm) |        |
|---------|--------|--------|--------|
| YT-3376 | 6.0    | 75     | 25/100 |

| YATO    | Ø (mm) | H (mm) |        |
|---------|--------|--------|--------|
| YT-3377 | 6.0    | 100    | 25/100 |

- GB Electrician's hole saw kit
- D Lochsägensatz für Elektriker
- PL Zestaw otwornic dla elektryków
- RUS Набор ножовок к отверстиям для электриков
- CZ Sada vrtacích korunek pro elektrikáře
- H Koronafúró készlet villanyszerelőknek
- RO Set de găuritori pt. electricieni
- F Set de scies trépan aux électriciens
- I Set universale a tazza fresa con strumenti
- E Juego de sierras de marquetería para electricistas
- CN 双金属开孔器组套

|             |            |        |
|-------------|------------|--------|
| 8<br>PCS    | BI-METAL   | HSS M3 |
| ALLOY STEEL | 4-6<br>TPI | 40mm   |



BMC & COLOR SLEEVE

| YATO    | Ø (mm)                 |    |
|---------|------------------------|----|
| YT-3380 | 22; 29; 35; 44; 67; 73 | 10 |

10

- GB Combination hole saw kit
- D Universal-Lochsägensatz
- PL Uniwersalny zestaw otwornic
- RUS Универсальный набор ножовок к отверстиям
- CZ Univerzální sada vrtacích korunek
- H Univerzális koronafúró készlet
- RO Set univesal de găuritori
- F Set de scies trépan universelles
- I Set universale a tazza fresa con strumenti
- E Juego universal de sierras de marquetería
- CN 双金属开孔器组套

|             |            |        |
|-------------|------------|--------|
| 15<br>PCS   | BI-METAL   | HSS M3 |
| ALLOY STEEL | 4-6<br>TPI | 40mm   |



BMC & COLOR SLEEVE

| YATO    | Ø (mm)                                     |   |
|---------|--|---|
| YT-3381 | 19; 22; 25; 32; 35; 38; 44; 51; 57; 64; 76 | 5 |



GB Hand tap  
D Handgewindebohrer  
PL Gwintownik ręczny  
RUS Ручной метчик  
CZ Závětníky  
H Menetfúró

RO Tarozii  
F Taraud à main  
I Maschi filettatura a mano  
E Machos de rosca  
CN 三件套手用丝锥



SLIDING CARD



3  
PCS

DIN  
352

HSS  
M2

3-STAGE  
TAPPING

METRIC  
COARSE

| YATO    | size x pitch<br>rozmiar x skok gwintu | thread length (mm)<br>długość gwintu (mm) | L (mm) | shank diameter (mm)<br>średnica trzonu (mm) | PCS<br>packing: | weight (g)<br>waga (g) |         |
|---------|---------------------------------------|---|--------|---|-----------------|------------------------|---------|
| YT-2930 | M3x0.5                                | 11  | 40     | 3.5   | 3               | 25                     | 100/400 |
| YT-2931 | M4x0.7                                | 13  | 45     | 4.5   | 3               | 35                     | 50/200  |
| YT-2932 | M5x0.8                                | 16  | 50     | 6.0   | 3               | 45                     | 60/240  |
| YT-2933 | M6x1.0                                | 19  | 50     | 6.0   | 3               | 45                     | 60/240  |
| YT-2934 | M7x1.0                                | 19  | 50     | 6.0   | 3               | 55                     | 75/300  |
| YT-2935 | M8x1.25                               | 22  | 56     | 6.0   | 3               | 60                     | 50/200  |
| YT-2937 | M10x1.5                               | 24  | 70     | 7.0   | 3               | 85                     | 50/200  |

| YATO    | size x pitch<br>rozmiar x skok gwintu | thread length (mm)<br>długość gwintu (mm) | L (mm) | shank diameter (mm)<br>średnica trzonu (mm) | PCS<br>packing: | weight (g)<br>waga (g) |        |
|---------|---------------------------------------|---|--------|---|-----------------|------------------------|--------|
| YT-2939 | M12x1.75                              | 29  | 75     | 9.0   | 3               | 125                    | 50/200 |
| YT-2940 | M14x2.0                               | 30  | 80     | 10.5  | 3               | 200                    | 20/80  |
| YT-2941 | M16x2.0                               | 32  | 80     | 11.0  | 3               | 235                    | 20/80  |
| YT-2942 | M18x2.5                               | 40  | 95     | 12.0  | 3               | 345                    | 20/80  |
| YT-2943 | M20x2.5                               | 40  | 95     | 14.0  | 3               | 445                    | 10/40  |
| YT-2926 | M22x2.5                               | 40  | 100    | 18.0  | 3               | 600                    | 10/40  |
| YT-2927 | M24x3.0                               | 50  | 110    | 18.0  | 3               | 700                    | 15/30  |

GB Machine tap  
D Maschinengewindebohrer  
PL Gwintownik maszynowy  
RUS Машинный метчик  
CZ Strojní závětník  
H Gépi menetfúró

RO Tarod de mașină  
F Taraud machine  
I Maschi filettatura  
E Macho mecanico  
CN 机用丝锥

DIN  
371M

HSS  
M2

1-STAGE  
TAPPING

METRIC  
COARSE

GB Machine tap  
D Maschinengewindebohrer  
PL Gwintownik maszynowy  
RUS Машинный метчик  
CZ Strojní závětník  
H Gépi menetfúró

RO Tarod de mașină  
F Taraud machine  
I Maschi filettatura  
E Macho mecanico  
CN 机用丝锥

DIN  
376

HSS  
M2

1-STAGE  
TAPPING

METRIC  
COARSE



SLIDING CARD



SLIDING CARD



| YATO    | size x pitch<br>rozmiar x skok gwintu | thread length (mm)<br>długość gwintu (mm) | L (mm) | shank diameter (mm)<br>średnica trzonu (mm) | weight (g)<br>waga (g) |         |
|---------|---------------------------------------|---|--------|---|------------------------|---------|
| YT-2950 | M3x0.5                                | 11  | 56     | 3.5   | 15                     | 100/400 |
| YT-2951 | M4x0.7                                | 13  | 63     | 4.5   | 20                     | 100/400 |
| YT-2952 | M5x0.8                                | 16  | 70     | 6.0   | 25                     | 60/240  |
| YT-2953 | M6x1.0                                | 19  | 80     | 6.0   | 30                     | 50/200  |
| YT-2954 | M7x1.0                                | 19  | 80     | 7.1   | 35                     | 30/120  |
| YT-2955 | M8x1.25                               | 22  | 90     | 8.0   | 45                     | 50/200  |
| YT-2956 | M10x1.5                               | 24  | 100    | 10.0  | 65                     | 50/200  |

| YATO    | size x pitch<br>rozmiar x skok gwintu | thread length (mm)<br>długość gwintu (mm) | L (mm) | shank diameter (mm)<br>średnica trzonu (mm) | weight (g)<br>waga (g) |        |
|---------|---------------------------------------|---|--------|---|------------------------|--------|
| YT-2944 | M12x1.75                              | 29  | 110    | 9.0   | 70                     | 25/100 |
| YT-2945 | M14x2.0                               | 30  | 110    | 11.0  | 110                    | 25/100 |
| YT-2946 | M16x2.0                               | 32  | 110    | 12.0  | 120                    | 25/100 |
| YT-2947 | M18x2.5                               | 34  | 125    | 14.0  | 200                    | 25/100 |
| YT-2948 | M20x2.5                               | 34  | 140    | 16.0  | 260                    | 25/100 |
| YT-2949 | M22x2.5                               | 34  | 140    | 18.0  | 340                    | 20/80  |
| YT-2957 | M24x3.0                               | 38  | 160    | 18.0  | 400                    | 15/60  |
| YT-2958 | M27x3.0                               | 38  | 160    | 20.0  | 500                    | 15/60  |
| YT-2959 | M30x3.5                               | 45  | 180    | 22.0  | 700                    | 15/60  |

GB Taps and dies set  
D Gewindefschneidwerkzeug-Satz  
PL Zestaw narzynek i gwintowników  
RUS Набор плашек и метчиков  
CZ Souprava závětníků  
a kruhových závitových čelistí  
H Menetfúró és menetvágó készlet  
RO Set de tarozii și filiere  
F Set de filières et tarauds  
I Set di filiera a maschi  
E Juego de machos de rosca y cojinetes  
CN 丝锥板牙组套

METAL CASE  
& COLOR BOX



HSS



44  
PCS

DIN223  
DIN225  
DIN338  
DIN352  
DIN1814



YATO

size / rozmiar

YT-2978

M3; M4; M5; M6; M8; M10; M12



4

32  
PCS

DIN223  
DIN352



56  
PCS

DIN223  
DIN225  
DIN352  
DIN1814



YATO

size / rozmiar

YT-2979

M3; M4; M5; M6; M8; M10; M12; M14; M16; M18; M20



2

GB Taps set  
 D Gewinbeschneidwerkzeug-Satz  
 PL Zestaw gwintowników  
 RUS Набор метчиков  
 CZ Souprava závitníků  
 H Menetfúró készlet  
 RO Set de tarozi  
 F Set de tarauds  
 I Set di filettature  
 E Juego de machos de roscar  
 CN 丝锥组套



21 PCS

DIN 352

29 PCS

DIN338  
 DIN352  
 DIN1814



| YATO    | size / rozmiar               |    |
|---------|------------------------------|----|
| YT-2976 | M3; M4; M5; M6; M8; M10; M12 | 20 |

| YATO    | size / rozmiar               |    |
|---------|------------------------------|----|
| YT-2977 | M3; M4; M5; M6; M8; M10; M12 | 12 |

GB Circular die  
 D Schneideisen  
 PL Narzynka  
 RUS Плашка  
 CZ Kruhová závitová čelist

H Menetvágó  
 RO Filieră  
 F Filière  
 I Filiere tonde

E Cojinete de roscar  
 CN 圆板牙



| YATO    | size x pitch<br>rozmiar x skok gwintu | outside diameter (mm)<br>średnica zewnętrzna (mm) | thickness (mm)<br>grubość (mm) | weight (g)<br>waga (g) |         |
|---------|---------------------------------------|---|--------------------------------|------------------------|---------|
| YT-2961 | M4x0.7                                | 20  | 5                              | 20                     | 125/500 |
| YT-2962 | M5x0.8                                | 20  | 7                              | 20                     | 100/400 |
| YT-2963 | M6x1.0                                | 20  | 7                              | 20                     | 100/400 |
| YT-2964 | M7x1.0                                | 25  | 9                              | 35                     | 100/200 |
| YT-2965 | M8x1.25                               | 25  | 9                              | 35                     | 100/400 |
| YT-2967 | M10x1.5                               | 30  | 11                             | 50                     | 70/280  |
| YT-2969 | M12x1.75                              | 38  | 14                             | 90                     | 60/240  |
| YT-2970 | M14x2.0                               | 38  | 14                             | 95                     | 63/252  |

| YATO    | size x pitch<br>rozmiar x skok gwintu | outside diameter (mm)<br>średnica zewnętrzna (mm) | thickness (mm)<br>grubość (mm) | weight (g)<br>waga (g) |        |
|---------|---------------------------------------|---|--------------------------------|------------------------|--------|
| YT-2971 | M16x2.0                               | 45  | 18                             | 160                    | 50/200 |
| YT-2972 | M18x2.5                               | 45  | 18                             | 160                    | 50/200 |
| YT-2973 | M20x2.5                               | 45  | 18                             | 150                    | 50/200 |
| YT-2960 | M22x2.5                               | 55  | 22                             | 300                    | 20/80  |
| YT-2966 | M24x3.0                               | 55  | 22                             | 300                    | 20/80  |
| YT-2968 | M27x3.0                               | 65  | 25                             | 400                    | 15/60  |
| YT-2974 | M30x3.5                               | 65  | 25                             | 400                    | 15/60  |

SLIDING CARD



10

GB T-handle tap wrench  
 D Werkzeughalter für Gewinde  
 PL Pokrętko typu „T” do gwintowników  
 RUS Рукоятка типа „Т” к гаечному ключу  
 CZ Vratidlo na závitníky typ „T”  
 H Menetfúró befogó T-nyelű  
 RO Port tarod cu maner  
 F Porte-taraud type „T”  
 I Chiave giramaschio tipo „T” per maschi  
 E Llave giramachos „T”  
 CN 丝锥铰手



SLIDING CARD



| YATO    | size / rozmiar | L (mm) |       |
|---------|----------------|--------|-------|
| YT-2986 | M3-M8          | 70     | 20/80 |
| YT-2987 | M5-M10         | 80     | 20/80 |
| YT-2988 | M6-M12         | 90     | 20/80 |

GB Ratchet tap wrench  
 D Werkzeughalter  
 PL Grzechotka do gwintownika  
 RUS Трещетка для метчика  
 CZ Řečtačka na závitník  
 H Racsnis hajtószár menetfúróhoz  
 RO Port tarod  
 F Porte-taraud à cliquet  
 I Chiave giramaschi a cricchetto  
 E Carraca para macho de roscar  
 CN 棘轮丝锥铰手



SLIDING CARD



| YATO    | size / rozmiar | L (mm) |       |
|---------|----------------|--------|-------|
| YT-2989 | M3-M10         | 85     | 20/80 |
| YT-2997 | M3-M10         | 250    | 20/80 |
| YT-2990 | M5-M12         | 100    | 20/80 |
| YT-2991 | M5-M12         | 300    | 20/40 |

GB Die handle  
 D Schneideisenhalter  
 PL Oprawa do narzynek  
 RUS Плашкодержатель

CZ Závitová objímka  
 H Menetvágó tartó  
 RO Portfilieră  
 F Porte-filière

I Porta filiere  
 E Portacojinete  
 CN 板牙铰手



SLIDING CARD

| YATO    | size / rozmiar | Ø (mm) | L (mm) |        |
|---------|----------------|--------|--------|--------|
| YT-2980 | M3-M4          | 20x5   | 200    | 25/100 |
| YT-2981 | M4.5-M6        | 20x7   | 200    | 25/100 |
| YT-2982 | M7-M9          | 25x9   | 224    | 25/100 |
| YT-2983 | M10-M11        | 30x11  | 280    | 25/50  |
| YT-2984 | M12-M14        | 38x14  | 315    | 15/30  |
| YT-2985 | M16-M20        | 45x18  | 450    | 10/20  |

DIN 225

GB Tap wrench  
 D Werkzeughalter für Gewinde  
 PL Pokrętko do gwintowników

RUS Вороток для метчиков  
 CZ Ovládací kolečko na závitník  
 H Hajtószár menetfúróhoz

RO Cheie (mâner) pt. tarod  
 F Porte-taraud  
 I Manopola per il maschio

E Llave giramachos  
 CN 一型丝锥铰手



SLIDING CARD

| YATO    | size / rozmiar | L (mm) |        |
|---------|----------------|--------|--------|
| YT-2995 | M1-M8          | 125    | 50/200 |
| YT-2996 | M3-M10         | 180    | 25/100 |
| YT-2992 | M3-M12         | 200    | 25/100 |
| YT-2993 | M4-M12         | 280    | 25/100 |
| YT-2994 | M5-M20         | 375    | 20/40  |

DIN 1814



- GB Thread repair set  
D Reparatursatz für Gewinde  
PL Zestaw do naprawy gwintów  
RUS Набор для ремонта резьбы  
CZ Souprava na opravu závitů  
H Menetjavító készlet  
RO Set pt. reparare filete
- F Set d'helicoils  
I Kit di riparazione per filettature  
E Juego para reparar roscas  
CN 螺纹修复组套





HSS  
4341

STAINLESS  
STEEL  
NEROZEWA





88  
PCS

| YATO  | size / rozmiar      |  |
|--|---------------------|---|
| YT-1769  | M6 x 1.0 x 10.8 mm  | 5/10  |
|  | M8 x 1.25 x 10.8 mm |   |
|  | M10 x 1.5 x 13.5 mm |   |



131  
PCS

| YATO  | size / rozmiar       |  |
|--|----------------------|---|
| YT-1763  | M5 x 0.8 x 6.7 mm    | 5/10  |
|  | M6 x 1.0 x 10.8 mm   |   |
|  | M8 x 1.25 x 10.8 mm  |   |
|  | M10 x 1.5 x 13.5 mm  |   |
|  | M12 x 1.75 x 16.3 mm |   |



for / dla: YT-1763, YT-1769

STAINLESS  
STEEL  
NEROZEWA

- GB Wire threads  
D Spiraleinlagen für Gewindereparatur  
PL Wkłady spiralne do naprawy gwintów  
RUS Метчики и сверла для ремонта резьбы  
CZ Spirálové vložky na opravu závitů  
H Menetjavító betétek  
RO Insertii spirală pt. reparare filete  
F Helicoil  
I Inserti a spirale per riparazione  
E Elementos espirales para reparar roscas  
CN 螺纹修复组套



POLYBAG  
WITH  
HEADER

| YATO  | size / rozmiar       | PCS<br>packing |  |
|--|----------------------|----------------|---|
| YT-1764  | M5 x 0.8 x 6.7 mm    | 20             | 50/250  |
| YT-1765  | M6 x 1.0 x 10.8 mm   | 20             | 50/250  |
| YT-1766  | M8 x 1.25 x 10.8 mm  | 20             | 50/200  |
| YT-1767  | M10 x 1.5 x 13.5 mm  | 15             | 25/100  |
| YT-1768  | M12 x 1.75 x 16.3 mm | 10             | 25/100  |

- GB Router bit set
- D Oberfräsersatz
- PL Zestaw frezów do drewna
- RUS Набор фрез по дереву
- CZ Souprava frézů do dřeva
- H Medtjio frezj kompletas
- RO Set de freze pt. lemn
- F Fraises pour le bois
- I Set di frese per legno
- E Juego de frezas para madera
- CN 木工铣刀组套



ALUMINIUM CASE & COLOR SLEEVE



**ADDITIONAL TIP**

24 PCS

**YATO**

YT-6801

10

| Router bit parameter     |      |      |      |      |      |      |      |      |      |      |      |      |
|--------------------------|------|------|------|------|------|------|------|------|------|------|------|------|
| Shank diameter [mm]      | 8    | 8    | 8    | 8    | 8    | 8    | 8    | 8    | 8    | 8    | 8    | 8    |
| Length [mm]              | 42.0 | 47.0 | 47.0 | 43.5 | 50.0 | 51.5 | 51.0 | 52.0 | 58.0 | 51.5 | 58.0 | 56.5 |
| Router bit diameter [mm] | 12.7 | 12.7 | 9.5  | 12.7 | 12.7 | 9.5  | 12.7 | 16.0 | 6.35 | 6.35 | 9.5  | 12.7 |
| Cutting edge length [mm] | 12.7 | 14.8 | 11.6 | 13.0 | 12.5 | 20.0 | 20.0 | 9.5  | 19.5 | 20.0 | 24.5 | 25.0 |
| Curvature radius [mm]    | -    | -    | -    | -    | -    | 4.75 | 6.35 | -    | -    | -    | -    | -    |
| Bearing diameter [mm]    | -    | -    | -    | -    | -    | -    | -    | 12.7 | -    | -    | -    | -    |
| Angle [°]                | -    | 15   | 10   | -    | 45   | -    | -    | 15   | -    | -    | -    | -    |

| Router bit parameter     |      |      |      |      |      |      |      |      |      |      |      |      |
|--------------------------|------|------|------|------|------|------|------|------|------|------|------|------|
| Shank diameter [mm]      | 8    | 8    | 8    | 8    | 8    | 8    | 8    | 8    | 8    | 8    | 8    | 8    |
| Length [mm]              | 52.0 | 65.0 | 51.0 | 51.5 | 53.5 | 57.5 | 50.5 | 53.5 | 52.0 | 55.0 | 50.0 | 54.0 |
| Router bit diameter [mm] | 19.0 | 12.7 | 19.0 | 22.0 | 26.0 | 32.0 | 22.0 | 28.5 | 27.0 | 30.0 | 32.0 | 32.0 |
| Cutting edge length [mm] | 20.4 | 25.0 | 9.5  | 10.0 | 11.5 | 16.5 | 9.72 | 13.5 | 12.3 | 14.0 | 6.35 | 12.7 |
| Curvature radius [mm]    | -    | -    | 3.2  | 4.76 | 6.35 | 9.5  | 6.35 | 9.5  | 4.0  | -    | -    | -    |
| Bearing diameter [mm]    | -    | 12.7 | -    | 12.7 | 12.7 | 12.7 | 9.5  | 9.5  | 9.5  | 12.7 | 12.7 | 12.7 |
| Angle [°]                | -    | -    | -    | -    | -    | -    | -    | -    | -    | 45   | -    | -    |



35 PCS

**YATO**

YT-6803

10

| Router bit parameter     |       |      |      |      |      |      |      |       |      |      |      |      |      |      |      |      |      |      |      |      |      |      |
|--------------------------|-------|------|------|------|------|------|------|-------|------|------|------|------|------|------|------|------|------|------|------|------|------|------|
| Shank diameter [mm]      | 8     | 8    | 8    | 8    | 8    | 8    | 8    | 8     | 8    | 8    | 8    | 8    | 8    | 8    | 8    | 8    | 8    | 8    | 8    | 8    | 8    | 8    |
| Length [mm]              | 43.0  | 38.0 | 38.0 | 50.5 | 42.0 | 43.5 | 51.5 | 49.5  | 51.5 | 58.0 | 58.5 | 56.5 | 52.0 | 58.0 | 53.5 | 66.0 | 53.0 | 65.0 | -    | -    | -    | -    |
| Router bit diameter [mm] | 6.35  | 12.7 | 12.7 | 12.7 | 12.7 | 12.7 | 14.3 | 3.175 | 6.35 | 9.5  | 12.7 | 12.7 | 19.0 | 6.35 | 9.5  | 9.5  | 12.7 | 12.7 | 12.7 | 12.7 | 12.7 | 12.7 |
| Cutting edge length [mm] | 6.0   | 9.5  | 9.5  | 18.0 | 12.7 | 13.0 | 12.3 | 13.0  | 20.0 | 24.5 | 20.3 | 25.0 | 20.4 | 19.5 | 15.0 | 26.0 | 15.0 | 25.0 | -    | -    | -    | -    |
| Curvature radius [mm]    | 3.175 | 6.35 | -    | 6.35 | -    | -    | -    | -     | -    | -    | -    | -    | -    | -    | -    | -    | -    | -    | -    | -    | -    | -    |
| Bearing diameter [mm]    | -     | -    | -    | -    | -    | -    | -    | -     | -    | -    | -    | -    | -    | -    | -    | 9.5  | 9.5  | 12.7 | 12.7 | -    | -    | -    |
| Angle [°]                | -     | -    | 45   | -    | -    | 10   | 14   | -     | -    | -    | -    | -    | -    | -    | -    | -    | -    | -    | -    | -    | -    | -    |

| Router bit parameter     |      |      |      |      |      |      |      |      |      |      |      |      |       |      |      |      |      |   |   |   |   |   |
|--------------------------|------|------|------|------|------|------|------|------|------|------|------|------|-------|------|------|------|------|---|---|---|---|---|
| Shank diameter [mm]      | 8    | 8    | 8    | 8    | 8    | 8    | 8    | 8    | 8    | 8    | 8    | 8    | 8     | 8    | 8    | 8    | 8    | 8 | 8 | 8 | 8 | - |
| Length [mm]              | 65.5 | 55.0 | 51.0 | 55.0 | 50.0 | 52.5 | 54.0 | 55.5 | 60.0 | 60.0 | 56.0 | 60.0 | 52.5  | 58.0 | 53.5 | 57.5 | 61.0 | - | - | - | - | - |
| Router bit diameter [mm] | 19.0 | 30.0 | 26.0 | 32.0 | 32.0 | 32.0 | 32.0 | 32.0 | 32.0 | 38.0 | 32.0 | 38.0 | 26.0  | 38.0 | 26.0 | 32.0 | 38.0 | - | - | - | - | - |
| Cutting edge length [mm] | 26.0 | 14.0 | 9.7  | 13.3 | 6.35 | 8.0  | 9.5  | 15.0 | 18.5 | 20.0 | 16.0 | 19.0 | 12.5  | 17.8 | 11.5 | 16.5 | 20.8 | - | - | - | - | - |
| Curvature radius [mm]    | -    | -    | 6.35 | 9.5  | -    | -    | -    | 8.0  | 4.76 | 12.7 | 4.76 | 6.35 | 3.175 | 6.35 | 6.35 | 9.5  | 12.7 | - | - | - | - | - |
| Bearing diameter [mm]    | 19.0 | 12.7 | 12.7 | 12.7 | 12.7 | 12.7 | 12.7 | 9.5  | 12.7 | 9.5  | 9.5  | 9.5  | 9.5   | 9.5  | 9.5  | 12.7 | 12.7 | - | - | - | - | - |
| Angle [°]                | -    | 45   | -    | -    | -    | -    | -    | -    | -    | -    | -    | -    | -     | -    | -    | -    | -    | - | - | - | - | - |



GB Diamond blade  
D Diamant-Trennscheibe  
PL Tarcza diamentowa  
RUS Отрезной алмазный диск  
CZ Diamantový kotouč  
H Gyémántkorong

RO Disc cu diamant  
F Disque diamant  
I Disco diamantato  
E Disco de diamante  
CN 金刚石切片

DOUBLE  
BLISTER

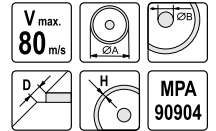



- application: concrete, brick, tile, masonry, stone
- przeznaczenie: beton utwardzony, cegła, granit, mur, kamień

- application: ceramic, glaze, glass, porcelain
- przeznaczenie: płytki ceramiczne, glazura, płytki kamienne, szkło, porcelana

- application: concrete, brick, tile, masonry, stone, sandstone
- przeznaczenie: beton utwardzony, cegła, granit, mur, kamień, piaskowiec

| YATO    | ∅A (mm) | ∅B (mm) | R.P.M.max. | D (mm) | H (mm) |  |
|---------|---------|---------|------------|--------|--------|---|
| YT-6002 | 115     | 22.2    | 12000      | 2.1    | 8.0    | 20/200  |
| YT-6003 | 125     | 22.2    | 11000      | 2.2    | 8.0    | 20/160  |
| YT-6004 | 180     | 22.2    | 8000       | 2.5    | 8.0    | 15/60   |
| YT-6005 | 230     | 22.2    | 6500       | 2.7    | 8.0    | 10/40   |

| YATO    | ∅A (mm) | ∅B (mm) | R.P.M.max. | D (mm) | H (mm) |  |
|---------|---------|---------|------------|--------|--------|---|
| YT-6012 | 115     | 22.2    | 12000      | 2.1    | 5.3    | 20/200  |
| YT-6013 | 125     | 22.2    | 11000      | 2.2    | 5.3    | 20/160  |
| YT-6014 | 180     | 22.2    | 8000       | 2.5    | 5.3    | 15/60   |
| YT-6015 | 230     | 22.2    | 6500       | 2.7    | 5.3    | 10/40   |
| YT-6016 | 180     | 25.4    | 8000       | 2.2    | 5.3    | 15/60   |
| YT-6017 | 200     | 25.4    | 8000       | 2.2    | 5.3    | 10/40   |

| YATO    | ∅A (mm) | ∅B (mm) | R.P.M.max. | D (mm) | H (mm) |  |
|---------|---------|---------|------------|--------|--------|---|
| YT-6022 | 115     | 22.2    | 12000      | 2.4    | 8.0    | 20/200  |
| YT-6023 | 125     | 22.2    | 11000      | 2.6    | 8.0    | 20/160  |
| YT-6024 | 180     | 22.2    | 8000       | 2.8    | 8.0    | 15/60   |
| YT-6025 | 230     | 22.2    | 6500       | 3.1    | 8.0    | 10/40   |

GB Diamond blade  
D Diamant-Trennscheibe  
PL Tarcza diamentowa  
RUS Отрезной алмазный диск  
CZ Diamantový kotouč  
H Gyémántkorong

RO Disc cu diamant  
F Disque diamant  
I Disco diamantato  
E Disco de diamante  
CN 金刚石切片

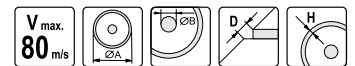

DOUBLE BLISTER





PAPER ENVELOPE



- application: concrete, reinforced concrete, clinkier, brick
- przeznaczenie: beton, beton zbrojony, klinkier, cegła

- application: concrete, reinforced concrete, clinkier, brick
- przeznaczenie: beton, beton zbrojony, klinkier, cegła

| YATO    | ∅A (mm) | ∅B (mm) | R.P.M.max. | D (mm) | H (mm) |  |
|---------|---------|---------|------------|--------|--------|---|
| YT-5953 | 300     | 25.4    | 5100       | 3.0    | 10.0   | 10  |
| YT-5954 | 350     | 25.4    | 4300       | 3.2    | 10.0   | 5   |
| YT-5955 | 400     | 25.4    | 3800       | 3.6    | 10.0   | 5   |

| YATO    | ∅A (mm) | ∅B (mm) | R.P.M.max. | D (mm) | H (mm) |  |
|---------|---------|---------|------------|--------|--------|---|
| YT-5956 | 450     | 25.4    | 3400       | 3.8    | 10.0   | 5   |



DOUBLE BLISTER





PAPER ENVELOPE



- application: natural stone, artificial stone
- przeznaczenie: kamień naturalny, kamień sztuczny

- application: natural stone, artificial stone
- przeznaczenie: kamień naturalny, kamień sztuczny

| YATO    | ∅A (mm) | ∅B (mm) | R.P.M.max. | D (mm) | H (mm) |  |
|---------|---------|---------|------------|--------|--------|---|
| YT-5965 | 400     | 25.4    | 3800       | 3.6    | 10.0   | 5   |

| YATO    | ∅A (mm) | ∅B (mm) | R.P.M.max. | D (mm) | H (mm) |  |
|---------|---------|---------|------------|--------|--------|---|
| YT-5966 | 450     | 25.4    | 3400       | 3.8    | 10.0   | 5   |

- GB Diamond blade
- D Diamant-Trennscheibe
- PL Tarcza diamentowa
- RUS Отрезной алмазный диск
- CZ Diamantový kotouč
- H Gyémántkorong
- RO Disc cu diamant
- F Disque diamant
- I Disco diamantato
- E Disco de diamante
- CN 金刚石切片

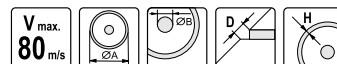

- application: ceramic tiles, thin natural stone tiles, glaze, glass, porcelain
- przeznaczenie: płytki ceramiczne, cienkie płytki z naturalnego kamienia, glazura, szkło, porcelana

DOUBLE BLISTER



- application: asphalt, checker brick, silicate, chamotte, fresh concrete materials, other ceramic building materials

DOUBLE BLISTER



- przeznaczenie: asfalt, cegła „kratówka”, silikaty, szamot, świeży beton, inne ściernalne materiały budowlane

| YATO    | ∅A (mm) | ∅B (mm) | RPM.max. | D (mm) | H (mm) | Box |
|---------|---------|---------|----------|--------|--------|-----|
| YT-5973 | 250     | 25.4    | 6100     | 1.8    | 10.0   | 20  |
| YT-5974 | 300     | 25.4    | 5100     | 2.1    | 10.0   | 10  |
| YT-5975 | 350     | 25.4    | 4300     | 2.4    | 10.0   | 5   |

| YATO    | ∅A (mm) | ∅B (mm) | RPM.max. | D (mm) | H (mm) | Box |
|---------|---------|---------|----------|--------|--------|-----|
| YT-5991 | 300     | 25.4    | 5100     | 3.2    | 10.0   | 10  |
| YT-5992 | 350     | 25.4    | 4300     | 3.2    | 10.0   | 5   |

10



- application: asphalt, checker brick, silicate, chamotte, fresh concrete materials, other ceramic building materials

PAPER ENVELOPE



- przeznaczenie: asfalt, cegła „kratówka”, silikaty, szamot, świeży beton, inne ściernalne materiały budowlane

| YATO    | ∅A (mm) | ∅B (mm) | RPM.max. | D (mm) | H (mm) | Box |
|---------|---------|---------|----------|--------|--------|-----|
| YT-5994 | 450     | 25.4    | 3400     | 3.6    | 10.0   | 5   |

- GB Diamond grinding cup wheel
- D Diamant Schleiftopf Schleifteller
- PL Tarcza szlifierska diamentowa
- RUS Алмазный диск шлифовальный
- CZ Diamantový brusný kotouč
- H Gyémánt csiszoló kúpos
- RO Disc cupa diamantat pt. slefuit
- F Disque diamant
- I Disco diamantato
- E Disco de diamante de lijar
- CN 金刚石杯型磨轮

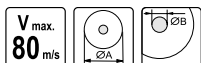

HANGING COLOR BOX



- application: concrete, clinker, natural stone
- przeznaczenie: beton, klinkier, kamień naturalny

| YATO    | ∅A (mm) | ∅B (mm) | RPM.max. | segment size (mm) | Box |
|---------|---------|---------|----------|-------------------|-----|
| YT-6030 | 125     | 22.2    | 12200    | 5.0x7.5           | 20  |
| YT-6032 | 125     | 22.2    | 12200    | 4.5x20.0          | 20  |

- GB Diamond core bit drilling holes for sockets
- D Diamant-Bohrkrone
- PL Diamentowe wiertło koronowe
- RUS Алмазное сверло корончатое
- CZ Diamantový korunkový vrták
- H Gyémánt fúrókorona
- RO Carota diamantata pt. beton
- F Trépiéd à mur diamantées
- I Corona diamantata per calcestruzzo
- E Corona con broca diamante
- CN 金刚石薄壁钻



COLOR BOX



| YATO    | ∅ (mm) | RPM.max. | segment size (mm) | Box |
|---------|--------|----------|-------------------|-----|
| YT-6045 | 68     | 1030     | 3.5x10x24         | 24  |
| YT-6046 | 82     | 850      | 3.5x10x24         | 20  |



GB TCT circular saw blade for wood  
D Kreissägeblatt HM-Bestückt  
PL Piła tarczowa do drewna z węglikiem wolframu  
RUS Диск пильный с карбидом вольфрама

CZ Kotoučová píla na dřevo z karbidem wolframu  
H Wolframkarbidos körfűrész fához  
RO Ferăstrău circular cu diuți din wolfram pt. lemn

F Lame de scie circulaire carburé  
I Lama troncatrice taglio legno  
E Disco de sierra con carbono de tungsteno  
CN 木工锯片

DOUBLE BLISTER

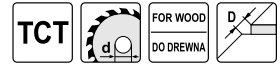

- application: for cutting wood and plastics
- przeznaczenie: do cięcia drewna, płyt drewnopochodnych, tworzyw sztucznych



| YATO    | Ø (mm) | d (mm) | R.P.M.max. | D (mm) | thickness of blade / grubość ostrza | T  | Box   |
|---------|--------|--------|------------|--------|-------------------------------------|----|-------|
| YT-6050 | 130    | 16.0   | 10000      | 2.8    | 2.0                                 | 24 | 25/50 |
| YT-6052 | 140    | 20.0   | 10000      | 2.8    | 2.0                                 | 16 | 25/50 |
| YT-6053 | 140    | 16.0   | 10000      | 2.8    | 2.0                                 | 30 | 25/50 |
| YT-6055 | 160    | 20.0   | 9500       | 2.8    | 2.0                                 | 18 | 25/50 |
| YT-6056 | 160    | 30.0   | 9500       | 2.8    | 2.0                                 | 24 | 25/50 |
| YT-6057 | 160    | 30.0   | 9500       | 2.8    | 2.0                                 | 36 | 25/50 |
| YT-6058 | 160    | 20.0   | 9500       | 2.8    | 2.0                                 | 48 | 25/50 |
| YT-6060 | 184    | 30.0   | 9000       | 3.2    | 2.2                                 | 24 | 25/50 |
| YT-6061 | 184    | 30.0   | 9000       | 3.2    | 2.2                                 | 40 | 25/50 |
| YT-6062 | 184    | 30.0   | 9000       | 3.2    | 2.2                                 | 50 | 25/50 |
| YT-6063 | 185    | 20.0   | 9000       | 2.4    | 1.4                                 | 18 | 25/50 |
| YT-6065 | 200    | 30.0   | 8000       | 3.2    | 2.2                                 | 24 | 10/20 |
| YT-6066 | 205    | 18.0   | 6000       | 3.2    | 2.0                                 | 24 | 10/20 |
| YT-6067 | 210    | 30.0   | 8000       | 3.2    | 2.2                                 | 40 | 10/20 |

| YATO    | Ø (mm) | d (mm) | R.P.M.max. | D (mm) | thickness of blade / grubość ostrza | T  | Box   |
|---------|--------|--------|------------|--------|-------------------------------------|----|-------|
| YT-6068 | 210    | 30.0   | 8000       | 3.2    | 2.2                                 | 60 | 10/20 |
| YT-6070 | 250    | 30.0   | 6000       | 3.2    | 2.2                                 | 24 | 10/20 |
| YT-6071 | 250    | 30.0   | 6000       | 3.2    | 2.2                                 | 40 | 10/20 |
| YT-6072 | 250    | 30.0   | 6000       | 3.2    | 2.2                                 | 60 | 10/20 |
| YT-6075 | 300    | 30.0   | 6000       | 3.2    | 2.2                                 | 24 | 10    |
| YT-6076 | 300    | 30.0   | 5000       | 3.2    | 2.2                                 | 40 | 10    |
| YT-6077 | 300    | 30.0   | 5000       | 3.2    | 2.2                                 | 60 | 10    |
| YT-6078 | 300    | 30.0   | 5000       | 3.2    | 2.2                                 | 96 | 10    |
| YT-6080 | 350    | 30.0   | 4500       | 3.5    | 2.5                                 | 28 | 10    |
| YT-6081 | 350    | 30.0   | 4500       | 3.5    | 2.5                                 | 40 | 10    |
| YT-6082 | 350    | 30.0   | 4500       | 3.5    | 2.5                                 | 54 | 10    |
| YT-6083 | 350    | 30.0   | 4500       | 3.5    | 2.5                                 | 84 | 10    |
| YT-6085 | 400    | 30.0   | 4000       | 3.8    | 2.8                                 | 32 | 10    |
| YT-6086 | 400    | 30.0   | 4000       | 3.8    | 2.8                                 | 60 | 10    |

GB TCT circular saw blade for aluminium  
D Hartmetallbestückt Kreissägeblatt für Aluminium  
PL Piła tarczowa do aluminium z węglikiem wolframu  
RUS Диск пильный по алюминию

CZ Kotoučová píla na hliník s karbidem wolframu  
H Wolframkarbidos körfűrészlap, alumíniumhoz  
RO Disc circular pt. aluminiu  
F Lame de scie circulaire pour aluminium

I Lama troncatrice alluminio  
E Disco de sierra con carbono  
CN 锯片

DOUBLE BLISTER

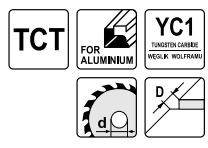

- application: for cutting aluminium profiles, laminates, plexi, corian and other plastics
- negative angle of teeth
- przeznaczenie: do cięcia profili aluminiowych, laminatów, plexi, korianu, tworzyw sztucznych
- negatywny kąt natarcia zębów



| YATO    | Ø (mm) | d (mm) | R.P.M.max. | D (mm) | thickness of blade / grubość ostrza | T   | Box   |
|---------|--------|--------|------------|--------|-------------------------------------|-----|-------|
| YT-6091 | 200    | 30     | 8000       | 3.0    | 2.2                                 | 60  | 10/20 |
| YT-6093 | 210    | 30     | 8000       | 3.0    | 2.2                                 | 72  | 10/20 |
| YT-6095 | 250    | 30     | 6000       | 3.0    | 2.2                                 | 100 | 10/20 |

| YATO    | Ø (mm) | d (mm) | R.P.M.max. | D (mm) | thickness of blade / grubość ostrza | T   | Box |
|---------|--------|--------|------------|--------|-------------------------------------|-----|-----|
| YT-6097 | 300    | 30     | 5000       | 3.0    | 2.2                                 | 100 | 10  |
| YT-6099 | 350    | 30     | 4500       | 3.2    | 2.5                                 | 100 | 10  |

GB Metal cutting disc  
D Trennscheibe für Metall  
PL Tarcza do cięcia metalu

RUS Диск отрезной по металлу  
CZ Kotouč pro řezání kovů  
H Vágókorong fémhez

RO Disc debitat metal  
F Lame de scie pour métaux  
I Disco per taglio metallo

E Disco cortador para metal  
CN 锯片

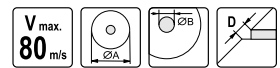

INOX

INOX

• depressed center • wypukła

| YATO    | ØA (mm) | ØB (mm) | D (mm) | R.P.M.max. | PCS packing | Box    |
|---------|---------|---------|--------|------------|-------------|--------|
| YT-6101 | 115     | 22      | 1.2    | 13200      | 5           | 25/200 |
| YT-6102 | 115     | 22      | 2.5    | 13200      | 5           | 25/200 |
| YT-6103 | 125     | 22      | 1.2    | 12200      | 5           | 25/200 |
| YT-6104 | 125     | 22      | 2.5    | 12200      | 5           | 25/200 |
| YT-6105 | 180     | 22      | 1.5    | 8600       | 5           | 25/50  |
| YT-6106 | 180     | 22      | 2.5    | 8600       | 5           | 25/100 |
| YT-6107 | 230     | 22      | 2.0    | 6500       | 5           | 25/50  |
| YT-6108 | 230     | 22      | 3.2    | 6500       | 5           | 25/50  |

| YATO    | ØA (mm) | ØB (mm) | D (mm) | R.P.M.max. | PCS packing | Box    |
|---------|---------|---------|--------|------------|-------------|--------|
| YT-5940 | 115     | 22      | 2.5    | 13200      | 5           | 25/200 |
| YT-5942 | 125     | 22      | 2.5    | 12200      | 5           | 25/200 |
| YT-5944 | 180     | 22      | 3.2    | 8600       | 5           | 25/50  |
| YT-5945 | 230     | 22      | 3.2    | 6500       | 5           | 25/50  |

| YATO    | ØA (mm) | ØB (mm) | D (mm) | R.P.M.max. | PCS packing | Box    |
|---------|---------|---------|--------|------------|-------------|--------|
| YT-5920 | 115     | 22      | 1.2    | 13200      | 5           | 25/200 |
| YT-5921 | 115     | 22      | 2.5    | 13200      | 5           | 25/200 |
| YT-5922 | 115     | 22      | 3.2    | 13200      | 5           | 25/200 |
| YT-5923 | 125     | 22      | 1.2    | 12200      | 5           | 25/200 |
| YT-5924 | 125     | 22      | 2.5    | 12200      | 5           | 25/200 |
| YT-6110 | 125     | 22      | 3.2    | 12200      | 5           | 25/200 |
| YT-5925 | 180     | 22      | 1.5    | 8600       | 5           | 25/50  |
| YT-5926 | 180     | 22      | 2.5    | 8600       | 5           | 25/50  |
| YT-6111 | 180     | 22      | 3.2    | 8600       | 5           | 25/100 |
| YT-5927 | 230     | 22      | 2.0    | 6500       | 5           | 25/50  |
| YT-6112 | 230     | 22      | 3.2    | 6500       | 5           | 25/50  |
| YT-6113 | 300     | 32      | 3.2    | 5100       | 5           | 25     |
| YT-6122 | 305     | 22      | 3.5    | 5100       | 5           | 10/20  |
| YT-6136 | 350     | 32      | 3.5    | 4400       | 5           | 25     |
| YT-6137 | 400     | 32      | 4.0    | 3800       | 5           | 25     |



GB Metal cutting disc  
 D Trennscheibe für Metall  
 PL Tarcza do cięcia metalu  
 RUS Диск отрезной по металлу  
 CZ Kotoúč pro řezání kovu  
 H Vágókorong fémhez  
 RO Disc debitat metale  
 F Lame de scie pour métaux  
 I Disco per taglio metallo  
 E Disco cortador para metalo  
 CN 锯片

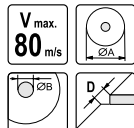

GB Metal grinding disc  
 D Metall-Schleifscheibe  
 PL Tarcza do szlifowania metalu  
 RUS Круги для шлифования по металлу  
 CZ Kotoúč pro broušení kovu  
 H Vágókorong fémhez

RO Disc pt. șlefuit metal  
 F Disque de polissage pour métaux  
 I Disco per rettifica metallo  
 E Disco cortador para metalo  
 CN 锯片

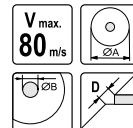

10

• depressed center • wypukła

| YATO    | ØA (mm) | ØB (mm) | D (mm) | Ø     | R.P.M.max. | PCS packing |  |
|---------|---------|---------|--------|-------|------------|-------------|--|
| YT-6114 | 115     | 22      | 2.5    | 13200 | 5          | 25/200      |  |
| YT-6115 | 115     | 22      | 3.2    | 13200 | 5          | 25/200      |  |
| YT-6116 | 125     | 22      | 2.5    | 12200 | 5          | 25/200      |  |
| YT-6117 | 125     | 22      | 3.2    | 12200 | 5          | 25/200      |  |
| YT-6119 | 180     | 22      | 3.2    | 8600  | 5          | 25/100      |  |
| YT-6120 | 230     | 22      | 3.2    | 6500  | 5          | 25/50       |  |

• depressed center • wypukła

| YATO    | ØA (mm) | ØB (mm) | D (mm) | Ø     | R.P.M.max. | PCS packing |  |
|---------|---------|---------|--------|-------|------------|-------------|--|
| YT-6121 | 115     | 22      | 6.0    | 13200 | 5          | 25/100      |  |
| YT-6123 | 115     | 22      | 8.0    | 13200 | 5          | 25/100      |  |
| YT-6124 | 125     | 22      | 6.0    | 12200 | 5          | 30/120      |  |
| YT-6126 | 125     | 22      | 8.0    | 12200 | 5          | 25/100      |  |
| YT-6138 | 180     | 22      | 6.8    | 8600  | 5          | 15/30       |  |
| YT-6125 | 230     | 22      | 6.0    | 6500  | 5          | 5/30        |  |

**INOX**

• depressed center • wypukła

| YATO    | ØA (mm) | ØB (mm) | D (mm) | Ø     | R.P.M.max. | PCS packing |  |
|---------|---------|---------|--------|-------|------------|-------------|--|
| YT-5946 | 115     | 22      | 6.0    | 13200 | 5          | 25/100      |  |
| YT-5947 | 125     | 22      | 6.8    | 12200 | 5          | 25/100      |  |
| YT-5948 | 180     | 22      | 6.8    | 8600  | 5          | 15/30       |  |
| YT-5949 | 230     | 22      | 6.8    | 6500  | 5          | 15/30       |  |

GB Stone cutting disc  
 D Trennscheibe für Stein  
 PL Tarcza do cięcia kamienia  
 RUS Диск отрезной по камню  
 CZ Kotoúč pro řezání kamene  
 H Vágókorong kőhöz

RO Disc pt. tăiat piatră  
 F Disque de coupe pour granit  
 I Disco per taglio pietra  
 E Disco cortador de piedra  
 CN 石材锯片

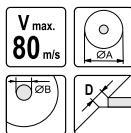

GB Stone grinding disc  
 D Stein-schleifscheibe  
 PL Tarcza do szlifowania kamienia  
 RUS Диск для шлифования по камню  
 CZ Kotoúč pro broušení kamene  
 H Csiszolókorong kőhöz  
 RO Disc pt. șlefuit piatră  
 F Disque de polissage pour granit  
 I Disco per rettifica pietra  
 E Disco cortador de piedra  
 CN 锯片

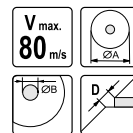

• depressed center • wypukła

| YATO    | ØA (mm) | ØB (mm) | D (mm) | Ø     | R.P.M.max. | PCS packing |  |
|---------|---------|---------|--------|-------|------------|-------------|--|
| YT-5930 | 115     | 22      | 1.5    | 13200 | 5          | 25/200      |  |
| YT-5932 | 125     | 22      | 1.5    | 12200 | 5          | 25/200      |  |
| YT-5933 | 125     | 22      | 3.2    | 12200 | 5          | 25/200      |  |
| YT-5934 | 180     | 22      | 3.2    | 8600  | 5          | 25/50       |  |
| YT-5935 | 230     | 22      | 3.2    | 6500  | 5          | 25/50       |  |

| YATO    | ØA (mm) | ØB (mm) | D (mm) | Ø     | R.P.M.max. | PCS packing |  |
|---------|---------|---------|--------|-------|------------|-------------|--|
| YT-6128 | 115     | 22      | 3.2    | 13200 | 5          | 25/200      |  |
| YT-6129 | 125     | 22      | 3.2    | 12200 | 5          | 25/200      |  |
| YT-6130 | 180     | 22      | 3.2    | 8600  | 5          | 25/100      |  |
| YT-6131 | 230     | 22      | 3.2    | 6500  | 5          | 25/50       |  |

• depressed center • wypukła

| YATO    | ØA (mm) | ØB (mm) | D (mm) | Ø     | R.P.M.max. | PCS packing |  |
|---------|---------|---------|--------|-------|------------|-------------|--|
| YT-6132 | 115     | 22      | 6.0    | 13200 | 5          | 25/100      |  |
| YT-6133 | 125     | 22      | 6.8    | 12200 | 5          | 25/100      |  |
| YT-6134 | 180     | 22      | 6.8    | 8600  | 5          | 15/30       |  |
| YT-6135 | 230     | 22      | 6.8    | 6500  | 5          | 15/30       |  |





- GB Cable cutter  
D Kabelschere  
PL Szczypce do cięcia przewodów  
RUS Кабелерезы  
CZ Elektrické upichováky  
H Kábelvágó  
RO Patent tăietor pt. electric  
F Pince à couper les fils  
I Pinze per tagliare i cavi  
E Tijeras para cables  
CN 电缆剪



SLIDING CARD



|   |        |   |
|---|--------|---|
|  | 160 mm | 210 mm  |
|  | 240 mm | CrV 50<br>DROP FORGED STEEL<br>STAL KUTA NA ZEMNO |
|   |        | HRC 55-60   |

| YATO  | L (mm) | max. Ø (mm) |  |
|--|--------|-------------|---|
| YT-1966  | 160    | 6           | 6/60  |
| YT-1967  | 210    | 7           | 6/60  |
| YT-1968  | 240    | 8           | 6/48  |

• application: for copper and aluminium electric cables

• przeznaczenie: do cięcia miedzianych i aluminiowych kabli



- GB Heavy duty cable cutter  
D Schwere Drahtschere  
PL Wzmocnione nożyce do cięcia przewodów  
RUS Кабелерезы  
CZ Elektrické upichováky  
H Kábelvágó  
RO Patent tăietor pt. electric  
F Pince renforcée à couper les fils  
I Pinze per tagliare i cavi  
E Tijeras para cables  
CN 电缆剪



SLIDING CARD



|   |        |   |           |
|---|--------|---|-----------|
|  | 240 mm | CrV 50<br>DROP FORGED STEEL<br>STAL KUTA NA ZEMNO | HRC 55-60 |
|---|--------|---|-----------|

| YATO  | L (mm) | max. Ø (mm) |  |
|--|--------|-------------|---|
| YT-1969  | 240    | 9           | 6/48  |

• application: for copper and aluminium electric cables

• przeznaczenie: do cięcia miedzianych i aluminiowych kabli



- GB Heavy duty cable cutter  
D Schwere Drahtschere  
PL Wzmocnione nożyce do cięcia przewodów  
RUS Кабелерезы  
CZ Elektrické upichováky  
H Kábelvágó  
RO Patent tăietor pt. electric  
F Pince renforcée à couper les fils  
I Pinze per tagliare i cavi  
E Tijeras para cables  
CN 电缆剪



SLIDING CARD



|  |        |  |      |
|--|--------|--|------|
|  | 230 mm | HRC 58-61                                      | CrMo |
| Lever for increase cutting power   |        | Ideal for copper and aluminium electric cables |      |

| YATO  | L (mm) | max. Ø (mm) |  |
|--|--------|-------------|---|
| YT-1933  | 230    | 9           | 6/36  |

- GB Tin snips  
D Blechschere  
PL Nożyce do cięcia blachy  
RUS Ножницы по металлу  
CZ Nůžky na plech  
H Lemezvágó olló  
RO Foarfece pt. tablă  
F Cisaille à tôle  
I Cesioie per lamiera  
E Tijeras para chapas  
CN 铁皮剪

SLIDING CARD



|   |           |  |
|---|-----------|--|
| S55C<br>DROP FORGED STEEL<br>STAL KUTA NA ZEMNO | HRC 55-60 | HIGH FREQUENCY HARDENING<br>HARTOWANIE IMPULSOWE |
|---|-----------|--|





- GB Tin snips  
D Blechschere  
PL Nożyce do cięcia blachy  
RUS Ножницы по металлу  
CZ Nůžky na plech  
H Lemezvágó olló  
RO Foarfece pt. tablă  
F Cisaille à tôle  
I Cesioie per lamiera  
E Tijeras para chapas  
CN 铁皮剪



SLIDING CARD



|   |           |  |
|---|-----------|--|
| S55C<br>DROP FORGED STEEL<br>STAL KUTA NA ZEMNO | HRC 55-60 | HIGH FREQUENCY HARDENING<br>HARTOWANIE IMPULSOWE |
|---|-----------|--|



| YATO  | L (mm) | cutting length (mm) | cutting capacities (mm) |                   |                  |                     |  |
|--|--------|---------------------|-------------------------|-------------------|------------------|---------------------|---|
|  |        |                     | copper                  | cold-rolled steel | hard steel HRC35 | stainless steel 304 |   |
| YT-1963  | 200    | 40                  | 1.5                     | 1.0               | 0.6              | 0.6                 | 6/36  |
| YT-1964  | 250    | 60                  | 1.8                     | 1.2               | 0.8              | 0.8                 | 6/24  |
| YT-1965  | 300    | 75                  | 2.0                     | 1.4               | 0.8              | 0.8                 | 6/12  |

| YATO  | L (mm) | cutting length (mm) | cutting capacities (mm) |                   |                  |                     |  |
|--|--------|---------------------|-------------------------|-------------------|------------------|---------------------|---|
|  |        |                     | copper                  | cold-rolled steel | hard steel HRC35 | stainless steel 304 |   |
| YT-1970  | 260    | 42                  | 2.0                     | 1.4               | 1.0              | 1.0                 | 6/36  |

- GB Tin snips
- D Blechscherer
- PL Nożyce do cięcia blachy
- RUS Ножницы по металлу
- CZ Nůžky na plech
- H Lemezvágó olló
- RO Foarfece pt. tablă
- F Cisaille à tôle
- I Cesioie per lamiera
- E Tijeras para chapas
- CN 铁皮剪



SLIDING CARD

**HRC 60-62** **DIN 6438** **CrMo**

INCREASED CUTTING POWER  
ZWIĘKSZONA SIŁA CIĘCIA



LEFT CUT  
CIĘCIE LEWE

| YATO    | L (mm) | cutting length (mm) | cutting capacities (mm) |                   |                  |                     | 6/36 |
|---------|--------|---------------------|-------------------------|-------------------|------------------|---------------------|------|
|         |        |                     | copper                  | cold-rolled steel | hard steel HRC35 | stainless steel 304 |      |
| YT-1910 | 260    | 35                  | 1.80                    | 1.50              | 1.00             | 0.90                | 6/36 |



RIGHT CUT  
CIĘCIE PRAWO

| YATO    | L (mm) | cutting length (mm) | cutting capacities (mm) |                   |                  |                     | 6/36 |
|---------|--------|---------------------|-------------------------|-------------------|------------------|---------------------|------|
|         |        |                     | copper                  | cold-rolled steel | hard steel HRC35 | stainless steel 304 |      |
| YT-1911 | 260    | 35                  | 1.80                    | 1.50              | 1.00             | 0.90                | 6/36 |



STRAIGHT CUT  
CIĘCIE PROSTE

| YATO    | L (mm) | cutting length (mm) | cutting capacities (mm) |                   |                  |                     | 6/36 |
|---------|--------|---------------------|-------------------------|-------------------|------------------|---------------------|------|
|         |        |                     | copper                  | cold-rolled steel | hard steel HRC35 | stainless steel 304 |      |
| YT-1912 | 260    | 35                  | 1.80                    | 1.50              | 1.00             | 0.90                | 6/36 |



LEFT CUT  
CIĘCIE LEWE

| YATO    | L (mm) | cutting length (mm) | cutting capacities (mm) |                   |                  |                     | 6/36 |
|---------|--------|---------------------|-------------------------|-------------------|------------------|---------------------|------|
|         |        |                     | copper                  | cold-rolled steel | hard steel HRC35 | stainless steel 304 |      |
| YT-1915 | 235    | 30                  | 1.50                    | 1.20              | 1.00             | 0.70                | 6/36 |



RIGHT CUT  
CIĘCIE PRAWO

| YATO    | L (mm) | cutting length (mm) | cutting capacities (mm) |                   |                  |                     | 6/36 |
|---------|--------|---------------------|-------------------------|-------------------|------------------|---------------------|------|
|         |        |                     | copper                  | cold-rolled steel | hard steel HRC35 | stainless steel 304 |      |
| YT-1916 | 235    | 30                  | 1.50                    | 1.20              | 1.00             | 0.70                | 6/36 |



LEFT CUT  
CIĘCIE LEWE

| YATO    | L (mm) | cutting length (mm) | cutting capacities (mm) |                   |                  |                     | 6/36 |
|---------|--------|---------------------|-------------------------|-------------------|------------------|---------------------|------|
|         |        |                     | copper                  | cold-rolled steel | hard steel HRC35 | stainless steel 304 |      |
| YT-1918 | 260    | 32                  | 1.80                    | 1.50              | 1.00             | 0.90                | 6/36 |



RIGHT CUT  
CIĘCIE PRAWO

| YATO    | L (mm) | cutting length (mm) | cutting capacities (mm) |                   |                  |                     | 6/36 |
|---------|--------|---------------------|-------------------------|-------------------|------------------|---------------------|------|
|         |        |                     | copper                  | cold-rolled steel | hard steel HRC35 | stainless steel 304 |      |
| YT-1919 | 260    | 32                  | 1.80                    | 1.50              | 1.00             | 0.90                | 6/36 |



STRAIGHT CUT  
CIĘCIE PROSTE

| YATO    | L (mm) | cutting length (mm) | cutting capacities (mm) |                   |                  |                     | 6/36 |
|---------|--------|---------------------|-------------------------|-------------------|------------------|---------------------|------|
|         |        |                     | copper                  | cold-rolled steel | hard steel HRC35 | stainless steel 304 |      |
| YT-1922 | 290    | 75                  | 1.10                    | 0.94              | 0.70             | 0.53                | 6/36 |



STRAIGHT CUT  
CIĘCIE PROSTE

| YATO    | L (mm) | cutting length (mm) | cutting capacities (mm) |                   |                  |                     | 6/36 |
|---------|--------|---------------------|-------------------------|-------------------|------------------|---------------------|------|
|         |        |                     | copper                  | cold-rolled steel | hard steel HRC35 | stainless steel 304 |      |
| YT-1923 | 230    | 25                  | 2.00                    | 1.60              | 1.20             | 1.20                | 6/36 |

- GB Tin snips
- D Blechscherer
- PL Nożyce do cięcia blachy
- RUS Ножницы по металлу
- CZ Nůžky na plech
- H Lemezvágó olló

- RO Foarfece pt. tablă
- F Cisaille à tôle
- I Cesioie per lamiera
- E Tijeras para chapas
- CN 铁皮剪



SLIDING CARD

**HRC 56-62** **CrMo**

INCREASED CUTTING POWER  
ZWIĘKSZONA SIŁA CIĘCIA  
SERATED EDGES  
ZARZKOWANA KRAWĘDZ  
OSTRY  
HIGH FREQUENCY HARDENING  
HARTOWANIE WIMPULSOWE



LEFT CUT  
CIĘCIE LEWE

| YATO    | L (mm) | cutting length (mm) | cutting capacities (mm) |                   |                  |                     | 6/36 |
|---------|--------|---------------------|-------------------------|-------------------|------------------|---------------------|------|
|         |        |                     | copper                  | cold-rolled steel | hard steel HRC35 | stainless steel 304 |      |
| YT-1960 | 250    | 40                  | 2.00                    | 1.50              | 1.00             | 0.80                | 6/36 |



RIGHT CUT  
CIĘCIE PRAWO

| YATO    | L (mm) | cutting length (mm) | cutting capacities (mm) |                   |                  |                     | 6/36 |
|---------|--------|---------------------|-------------------------|-------------------|------------------|---------------------|------|
|         |        |                     | copper                  | cold-rolled steel | hard steel HRC35 | stainless steel 304 |      |
| YT-1961 | 250    | 40                  | 2.00                    | 1.50              | 1.00             | 0.80                | 6/36 |



STRAIGHT CUT  
CIĘCIE PROSTE

| YATO    | L (mm) | cutting length (mm) | cutting capacities (mm) |                   |                  |                     | 6/36 |
|---------|--------|---------------------|-------------------------|-------------------|------------------|---------------------|------|
|         |        |                     | copper                  | cold-rolled steel | hard steel HRC35 | stainless steel 304 |      |
| YT-1962 | 250    | 45                  | 2.00                    | 1.50              | 1.00             | 0.80                | 6/36 |



- GB Tin snips  
D Blechscherer  
PL Nożyce do cięcia blachy  
RUS Ножницы по металлу  
CZ Nůžky na plech  
H Lemezvágó olló
- RO Foarfece pt. tablă  
F Cisaille à tôle  
I Cesioie per lamiera  
E Tijeras para chapas  
CN 铁皮剪

SLIDING  
CARD



For cutting  
straight and  
light curves  
left or right



HRC  
58-60



HRC  
58-61

| YATO    | L (mm) | cutting length (mm) | cutting capacities (mm) |                   |                  |                     | 6/36 |
|---------|--------|---------------------|-------------------------|-------------------|------------------|---------------------|------|
|         |        |                     | copper                  | cold-rolled steel | hard steel HRC35 | stainless steel 304 |      |
| YT-1920 | 260    | 42                  | 1.20                    | 1.00              | 0.60             | 0.50                | 6/36 |

| YATO    | L (mm) | cutting length (mm) | cutting capacities (mm) |                   |                  |                     | 6/36 |
|---------|--------|---------------------|-------------------------|-------------------|------------------|---------------------|------|
|         |        |                     | copper                  | cold-rolled steel | hard steel HRC35 | stainless steel 304 |      |
| YT-1924 | 254    | 52                  | 0.94                    | 0.78              | 0.60             | 0.45                | 6/36 |

- GB Tin snips  
D Blechscherer  
PL Nożyce do cięcia blachy  
RUS Ножницы по металлу  
CZ Nůžky na plech  
H Lemezvágó olló
- RO Foarfece pt. tablă  
F Cisaille à tôle  
I Cesioie per lamiera  
E Tijeras para chapas  
CN 铁皮剪

SLIDING  
CARD



DROP  
FORGED  
KUTE

HRC  
58-61



LEFT  
CUT  
CIECIE  
LEWE



RIGHT  
CUT  
CIECIE  
PRAWIE

| YATO    | L (mm) | cutting length (mm) | cutting capacities (mm) |                   |                  |                     | 6/24 |
|---------|--------|---------------------|-------------------------|-------------------|------------------|---------------------|------|
|         |        |                     | copper                  | cold-rolled steel | hard steel HRC35 | stainless steel 304 |      |
| YT-1900 | 260    | 30                  | 0.94                    | 0.78              | 0.60             | 0.45                | 6/24 |

| YATO    | L (mm) | cutting length (mm) | cutting capacities (mm) |                   |                  |                     | 6/24 |
|---------|--------|---------------------|-------------------------|-------------------|------------------|---------------------|------|
|         |        |                     | copper                  | cold-rolled steel | hard steel HRC35 | stainless steel 304 |      |
| YT-1901 | 260    | 30                  | 0.94                    | 0.78              | 0.60             | 0.45                | 6/24 |



RIGHT  
CUT  
CIECIE  
PRAWIE



STRAIGHT  
CUT  
CIECIE  
PROSTE

| YATO    | L (mm) | cutting length (mm) | cutting capacities (mm) |                   |                  |                     | 6/24 |
|---------|--------|---------------------|-------------------------|-------------------|------------------|---------------------|------|
|         |        |                     | copper                  | cold-rolled steel | hard steel HRC35 | stainless steel 304 |      |
| YT-1902 | 300    | 50                  | 0.94                    | 0.78              | 0.60             | 0.45                | 6/24 |

| YATO    | L (mm) | cutting length (mm) | cutting capacities (mm) |                   |                  |                     | 6/36 |
|---------|--------|---------------------|-------------------------|-------------------|------------------|---------------------|------|
|         |        |                     | copper                  | cold-rolled steel | hard steel HRC35 | stainless steel 304 |      |
| YT-1925 | 225    | 52                  | 0.94                    | 0.78              | 0.60             | 0.45                | 6/36 |

- GB Tin snips  
D Blechscherer  
PL Nożyce do cięcia blachy  
RUS Ножницы по металлу  
CZ Nůžky na plech  
H Lemezvágó olló
- RO Foarfece pt. tablă  
F Cisaille à tôle  
I Cesioie per lamiera  
E Tijeras para chapas  
CN 铁皮剪



SLIDING  
CARD



HRC  
60-62

CrMo

90°

SEPARATED  
EDGES  
ZABKOWANA  
KRAWĘDZ  
CIĘCZY



LEFT  
CUT  
CIECIE  
LEWE



RIGHT  
CUT  
CIECIE  
PRAWIE

| YATO    | L (mm) | cutting length (mm) | cutting capacities (mm) |                   |                  |                     | 6/36 |
|---------|--------|---------------------|-------------------------|-------------------|------------------|---------------------|------|
|         |        |                     | copper                  | cold-rolled steel | hard steel HRC35 | stainless steel 304 |      |
| YT-1913 | 225    | 30                  | 0.78                    | 0.53              | 0.46             | 0.36                | 6/36 |

| YATO    | L (mm) | cutting length (mm) | cutting capacities (mm) |                   |                  |                     | 6/36 |
|---------|--------|---------------------|-------------------------|-------------------|------------------|---------------------|------|
|         |        |                     | copper                  | cold-rolled steel | hard steel HRC35 | stainless steel 304 |      |
| YT-1914 | 225    | 30                  | 0.78                    | 0.53              | 0.46             | 0.36                | 6/36 |

GB Portable notchers  
 D Schere zum Ausschneiden von Ecken  
 PL Nożyce do wycinania naroży  
 RUS Ножницы для наружных углов  
 CZ Nůžky na vystřihování rohů  
 H Sarokkvágó olló  
 RO Foarfece pt. taiera ea colturilor

F Ciseaux pour le coupage des coins  
 I Cesoie per taglio reggetta in angoli  
 E Tijera para esquinas  
 CN 截角器

300 mm 90°

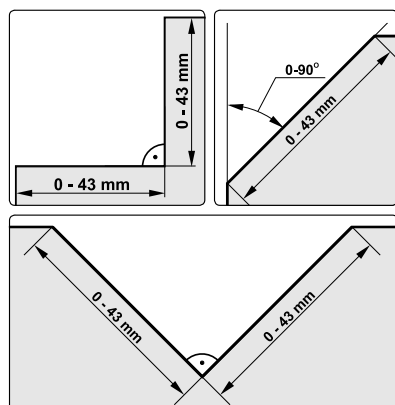

| YATO    | L (mm) |    |
|---------|--------|----|
| YT-1939 | 300    | 15 |

GB Steel strap cutter  
 D Stahlgurtblechschere  
 PL Nożyce do cięcia taśmy stalowej  
 RUS Ножницы для резки стальной ленты  
 CZ Nůžky na plech  
 H Lemezvágó olló  
 RO Foarfece pt. tablă  
 F Cisaille à bande acier  
 I Cesoia per taglio reggetta in acciaio  
 E Tijeras para bandejas de acero  
 CN 钢带剪

HRC 58-61

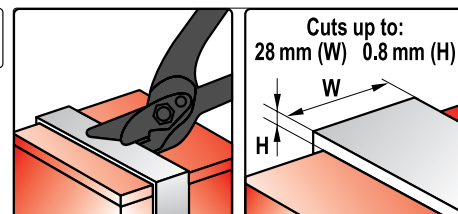

| YATO    | L (mm) | cutting length (mm) | cutting capacities (mm) |                   |                  |                     |      |
|---------|--------|---------------------|-------------------------|-------------------|------------------|---------------------|------|
|         |        |                     | copper                  | cold-rolled steel | hard steel HRC35 | stainless steel 304 |      |
| YT-1930 | 305    | 28                  | -                       | 1.00              | 0.80             | 0.60                | 6/24 |

GB Bolt cutter  
 D Drahtschere  
 PL Nożyce do prętów  
 RUS Болторез  
 CZ Nůžky na tyče  
 H Kábelvágó olló  
 RO Foarfece pt. bare

F Cisaille pour barres  
 I Cesoie taglia bulloni  
 E Cortavarillas  
 CN 断线钳

HRC 56-61 CrMo



| YATO    | size / rozmiar | max. Ø (mm)   |                         |    |
|---------|----------------|---------------|-------------------------|----|
|         |                | soft / miękki | medium / średnio twardy |    |
| YT-1843 | 12" (300 mm)   | 5             | 4                       | 20 |
| YT-1844 | 14" (350 mm)   | 7             | 5                       | 10 |
| YT-1845 | 18" (450 mm)   | 8             | 6                       | 10 |
| YT-1846 | 24" (600 mm)   | 10            | 8                       | 6  |
| YT-1847 | 30" (750 mm)   | 13            | 10                      | 4  |
| YT-1848 | 36" (900 mm)   | 16            | 12                      | 3  |

GB Bolt cutter  
 D Drahtschere  
 PL Nożyce do prętów  
 RUS Болторез  
 CZ Nůžky na tyče  
 H Kábelvágó olló  
 RO Foarfece pt. bare  
 F Cisaille pour barres  
 I Cesoie taglia bulloni  
 E Cortavarillas  
 CN 断线钳

CrMo



| YATO    | size / rozmiar | max. Ø (mm) |      |
|---------|----------------|-------------|------|
| YT-1851 | 14" (350 mm)   | 6           | 6/24 |
| YT-1852 | 18" (450 mm)   | 7           | 6/12 |
| YT-1853 | 24" (600 mm)   | 10          | 2/12 |

| YATO    | size / rozmiar | max. Ø (mm) |   |
|---------|----------------|-------------|---|
| YT-1854 | 30" (750 mm)   | 12          | 6 |
| YT-1855 | 36" (900 mm)   | 14          | 4 |
| YT-1856 | 42" (1050 mm)  | 16          | 2 |



GB Hydraulic cutter  
D Manueller Hydraulikschneider  
PL Ręczny obcinak hydrauliczny  
RUS Ручной гидравлический резак  
CZ Rucní hydraulický odřezávac  
H Kézi hidraulikus betonacélvágó  
RO Cutit pt. retezat tevi  
F Coupe manuelle hydraulique  
I Cesola idraulica manuale  
E Cortadora hidráulica manual  
CN 液压剪



STEEL  
STAL

BMC  
& COLOR  
SLEEVE



| YATO     | cutting diameter /<br>średnica cięcia (mm <sup>2</sup> ) | L (mm) | pressure / nacisk (T) |  |
|----------|--|--------|-----------------------|---|
| YT-22870 | 4-12   | 430    | 6                     | 5   |
| YT-22871 | 4-16   | 430    | 8                     | 5   |
| YT-22872 | 4-20   | 515    | 13                    | 3   |

GB Heads for hydraulic cutter  
D Austauschmesser für Hydraulikschneider  
PL Noże wymienne do obcinaka hydraulicznego  
RUS Сменные ножи для гидравлического резака

CZ Vyměnitelné nože do hydraulického odřezávače  
H Cserekes a hidraulikus betonacélvágóhoz  
RO Lame schimbabile pt. cutit pt. retezat tevi  
F Lame pour coupe manuelle hydraulique

I Teste per coltelli idraulici  
E Cuchillas intercambiables para cortadora hidráulica  
CN 液压钳钳口配件

2  
PCS



SLIDING  
CARD



| YATO     | for / dla | size / rozmiar (mm) |  |
|----------|-----------|---------------------|---|
| YT-22873 | YT-22870  | 12                  | 10/100  |
| YT-22874 | YT-22871  | 16                  | 10/100  |
| YT-22875 | YT-22872  | 20                  | 10/100  |

GB Ratchet cable cutter  
D Ratschenkabelschneider  
PL Nożyce zapadkowe do kabli  
RUS Кабелерез секторный

CZ Kleště na kabely, rohatka se západkou  
H Racsnis kábelvágó  
RO Cleste pt. taiat cablu cu clichet

F Cisailles à câbles  
I Cricchetto taglia cavo  
E Cortacables de carraca  
CN 棘轮电缆剪

COLOR BOX



Cu/Al  
CABLE  
KABEL

60Si2Mn

HRC 50  
CUTTING BLADE  
OSTRZE TNAČE

10

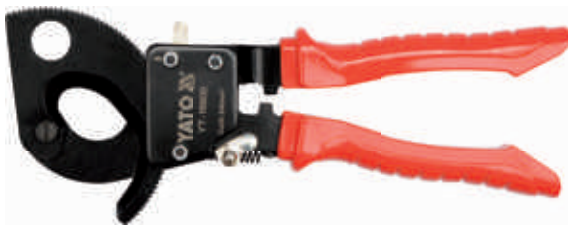

| YATO     | cutting range /<br>max. przekrój cięcia (mm <sup>2</sup> ) | L (mm) |  |
|----------|--|--------|---|
| YT-18600 | 240  | 300    | 10  |

| YATO     | cutting range /<br>max. przekrój cięcia (mm <sup>2</sup> ) | L (mm) |  |
|----------|--|--------|---|
| YT-18602 | 380  | 380    | 10  |

GB Cable cutter  
D Kabelschere  
PL Nożyce do kabli  
RUS Кабелерезы  
CZ Elektrické upichováky  
H Kábelvágó  
RO Patent tăietor pt. electrice  
F Cisailles à câbles  
I Cesole per cavi  
E Tijeras para cables  
CN 电缆剪



COLOR BOX



STEEL  
STAL

| YATO     | cutting range /<br>max. przekrój cięcia (mm <sup>2</sup> ) | L (mm) |  |
|----------|--|--------|---|
| YT-18610 | 125  | 370    | 20  |
| YT-18611 | 250  | 580    | 10  |
| YT-18612 | 500  | 770    | 5   |

GB Multi function scissors  
D Multifunktionsmesser  
PL Nożyce wielofunkcyjne  
RUS Ножницы многофункциональные  
CZ Víceúčelové nůžky  
H Többfunkciós olló  
RO Foarfece multifuncțional  
F Cisailles universelle  
I Cesole multifunzione  
E Tijeras multifuncionales  
CN 多用剪



65  
mm

3Cr13  
STAINLESS  
STEEL  
STAL  
NIERÓŻEWNIA

HRC  
50-54

SLIDING  
CARD



| YATO    | L (mm) |  |
|---------|--------|---|
| YT-1976 | 65     | 12/72   |

GB Hand saw for wood  
 D Handsäge  
 PL Pila platnica do drewna  
 RUS Пила по дереву  
 CZ Pila na dřevo platnice  
 H Fafűrész, egyenes  
 RO Ferăstrău pt. lemn  
 F Scie  
 I Seghetto per legno  
 E Serrucho para madera  
 CN 手板锯



COLOR SLEEVE

Mn 65  
 7T  
 inch  
 1.6 mm  
 0.9 mm  
 HRC 50-54

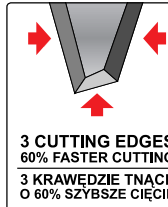

GB Back saw  
 D Rücksäge  
 PL Pila grzbietnica  
 RUS Пила для стула  
 CZ Pila hřebenovka  
 H Kézifűrész  
 RO Ferăstrău coadă de vulpe  
 F Scie  
 I Segà con dorso  
 E Serrucho de costilla  
 CN 夹背锯

300 mm  
 Mn 65  
 12T  
 inch  
 1.2 mm  
 0.8 mm  
 HRC 50-54



COLOR SLEEVE



| YATO    | L (mm) |       |
|---------|--------|-------|
| YT-3101 | 400    | 12/48 |
| YT-3102 | 450    | 10/40 |
| YT-3103 | 500    | 10/40 |

| YATO    | L (mm) |       |
|---------|--------|-------|
| YT-3130 | 300    | 12/60 |

PTFE  
 COATED

| YATO    | L (mm) |       |
|---------|--------|-------|
| YT-3106 | 400    | 12/48 |
| YT-3107 | 450    | 10/40 |
| YT-3108 | 500    | 10/40 |

GB Compass saw  
 D Stichsäge  
 PL Pila otwornica  
 RUS Выкружная пила  
 CZ Pila otwornice  
 H Lyukfűrész  
 RO Ferăstrău coadă de șoarece  
 F Scie étroite  
 I Segà a foretto  
 E Serrucho de punta  
 CN 鸡尾锯

300 mm  
 Mn 65  
 7T  
 inch  
 1.6 mm  
 0.9 mm  
 HRC 50-54



COLOR SLEEVE

| YATO    | L (mm) |       |
|---------|--------|-------|
| YT-3133 | 300    | 12/60 |

GB Wallboard saw  
 D Gipsäge  
 PL Pila do gipsów  
 RUS Ножовка по гипсокартону  
 CZ Pila na sádru  
 H Gipszfűrész  
 RO Ferăstrău pt. ghips  
 F Scie pour plaques de plâtre  
 I Segà per cartongesso  
 E Serrucho para cartón yeso  
 CN 墙板锯

150 mm  
 Mn 65  
 7T  
 inch  
 2.0 mm  
 1.5 mm  
 HRC 50-54



COLOR SLEEVE

| YATO    | L (mm) |       |
|---------|--------|-------|
| YT-3134 | 150    | 12/60 |

GB Plastic mitre box with dovetail saw  
 D Kunststoffschneidladen mit Säge  
 PL Plastikowa skrzynka uciosowa z pilą  
 RUS Стуло пластмассовое с пилой  
 CZ Přípravek na řezání úhlů s pilkou  
 H Gërbëvågó múanyagláda hód farkú fűrészszel  
 RO Pasuitor + cutie  
 F Boîte à onglets + scie  
 I Taglia cornici in plastica con sega  
 E Guía de ingletar y sierra  
 CN 燕尾锯



COLOR BOX

350 mm  
 Mn 65  
 12T  
 inch  
 1.2 mm  
 0.8 mm  
 HRC 50-54  
 ABS  
 300x140 x70mm



| YATO    | L (mm) |    |
|---------|--------|----|
| YT-3150 | 350    | 10 |

GB Bow saw  
 D Bùgelsäge  
 PL Pila kablakowa  
 RUS Лучковая пила  
 CZ Oblouková pila  
 H Keretes fűrész  
 RO Ferăstrău de curbură  
 F Scie à bûches  
 I Segà ad arco  
 E Sierra de arco  
 CN 两用弓锯

COLOR SLEEVE



HCS 65



FOR WOOD  
 DO DREWNA

| YATO    | L (mm) |       |
|---------|--------|-------|
| YT-3201 | 450    | 12/24 |
| YT-3202 | 530    |       |
| YT-3203 | 610    |       |
| YT-3204 | 760    |       |

2  
 FUNCTION

FOR WOOD  
 AND METAL  
 DO DREWNA  
 I METALU

| YATO    | L (mm) |       |
|---------|--------|-------|
| YT-3200 | 300    | 12/24 |



GB Blade for dry wood  
D Trockenholzsägeblatt für Handsäge  
PL Brzesczot do drewna suchego  
RUS Лезвие для работы по сухому дереву  
CZ Pilový list na suché dřevo

H Fűrészlap száraz fához  
RO Lama pt. lemn uscat  
F lame à bois sec  
I Lama per il legno secco  
E Hoja de sierra para madera seca  
CN 干木锯条

HCS  
65

DRY  
WOOD  
DREWNO  
SUCHE



COLOR SLEEVE

| YATO    | L (mm) |        |
|---------|--------|--------|
| YT-3221 | 450    | 50/200 |
| YT-3222 | 530    |        |
| YT-3223 | 610    |        |
| YT-3224 | 760    |        |

GB Blade for wet wood  
D Nassholzsägeblatt für Handsäge  
PL Brzesczot do drewna mokrego  
RUS Лезвие для работы по влажному дереву  
CZ Pilový list na mokré dřevo

H Fűrészlap nedves fához  
RO Lama pt. lemn verde  
F lame à bois humide  
I Lama per il legno bagnato  
E Hoja de sierra para madera mojada  
CN 湿木锯条

HCS  
65

WET  
WOOD  
DREWNO  
MOKRE



COLOR SLEEVE

| YATO    | L (mm) |        |
|---------|--------|--------|
| YT-3230 | 300    | 50/200 |
| YT-3231 | 450    |        |
| YT-3232 | 530    |        |
| YT-3233 | 610    |        |
| YT-3234 | 760    |        |

GB Hacksaw frame  
D Metallbogensäge  
PL Piła do metalu  
RUS Пила по металлу  
CZ Pílka na železo  
H Fémfűrész

RO Ferăstrău cu cadru metalic  
F Scie à métal  
I Seghetto per metallo  
E Sierra de metalo  
CN 锯架

COLOR  
SLEEVE



BI-METAL

24  
TPI

FOR  
METAL  
DO  
METALU



| YATO    | L (mm) |    |
|---------|--------|----|
| YT-3160 | 300    | 10 |



| YATO    | L (mm) |      |
|---------|--------|------|
| YT-3161 | 300    | 6/36 |



| YATO    | L (mm) |      |
|---------|--------|------|
| YT-3163 | 300    | 5/20 |

GB Hacksaw frame blade  
D Metallsägeblatt  
PL Brzesczot do metalu

RUS Полотно по металлу  
CZ Pilový list na kovy  
H Fémfűrész lap

RO Panza fierastrau pt. metal  
F lame à métal  
I Lama per metallo

E Hoja de sierra para metalo  
CN 锯条

300  
mm

12  
mm

24  
TPI



PLASTIC  
HANGER



BI-METAL  
M2+6150

| YATO    | L (mm) | W (mm) | TPI | PCS<br>packing: |        |
|---------|--------|--------|-----|-----------------|--------|
| YT-3460 | 300    | 12     | 24  | 5               | 10/200 |

| YATO    | L (mm) | W (mm) | TPI | PCS<br>packing: |        |
|---------|--------|--------|-----|-----------------|--------|
| YT-3461 | 300    | 12     | 24  | 2               | 20/500 |

BI-METAL  
M2+Co8%

| YATO    | L (mm) | W (mm) | TPI | PCS<br>packing: |        |
|---------|--------|--------|-----|-----------------|--------|
| YT-3462 | 300    | 12     | 24  | 2               | 20/500 |

GB Jig saw blades  
D Stichsägeblätter  
PL Brzeczoty do wyrzynarki  
RUS Полотно для электр. станка

CZ Pilový list do přímočaré pily  
H Dekopírlap  
RO Lama fierastrau pendular  
F Lames à scie sauteuse

I Scalpelli per il seghetto  
E Recambio sierra de calar  
CN 曲线锯条

BLISTER CARD



5  
PCS

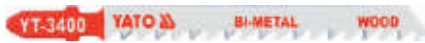

| YATO    | L (mm) | working length (mm) | thickness (mm) | TPI |        |
|---------|--------|---------------------|----------------|-----|--------|
| YT-3400 | 100    | 75                  | 1.27           | 6   | 50/250 |

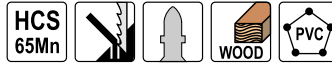

| YATO    | L (mm) | working length (mm) | thickness (mm) | TPI |        |
|---------|--------|---------------------|----------------|-----|--------|
| YT-3401 | 100    | 75                  | 1.3            | 10  | 50/250 |



| YATO    | L (mm) | working length (mm) | thickness (mm) | TPI |        |
|---------|--------|---------------------|----------------|-----|--------|
| YT-3402 | 100    | 75                  | 1.2            | 8   | 50/250 |



| YATO    | L (mm) | working length (mm) | thickness (mm) | TPI |        |
|---------|--------|---------------------|----------------|-----|--------|
| YT-3403 | 100    | 75                  | 1.3            | 6   | 50/250 |



| YATO    | L (mm) | working length (mm) | thickness (mm) | TPI |        |
|---------|--------|---------------------|----------------|-----|--------|
| YT-3404 | 100    | 75                  | 1.3            | 10  | 50/250 |



| YATO    | L (mm) | working length (mm) | thickness (mm) | TPI |        |
|---------|--------|---------------------|----------------|-----|--------|
| YT-3405 | 100    | 75                  | 1.3            | 6   | 50/250 |

10



| YATO    | L (mm) | working length (mm) | thickness (mm) | TPI |        |
|---------|--------|---------------------|----------------|-----|--------|
| YT-3407 | 75     | 50                  | 1.0            | 13  | 50/250 |



| YATO    | L (mm) | working length (mm) | thickness (mm) | TPI  |        |
|---------|--------|---------------------|----------------|------|--------|
| YT-3408 | 115    | 90                  | 1.3            | 13-8 | 50/250 |



| YATO    | L (mm) | working length (mm) | thickness (mm) | TPI |        |
|---------|--------|---------------------|----------------|-----|--------|
| YT-3409 | 115    | 90                  | 1.3            | 8   | 50/250 |



| YATO    | L (mm) | working length (mm) | thickness (mm) | TPI |        |
|---------|--------|---------------------|----------------|-----|--------|
| YT-3410 | 100    | 75                  | 1.4            | 6   | 50/250 |

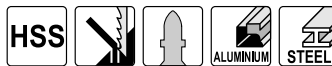

| YATO    | L (mm) | working length (mm) | thickness (mm) | TPI |        |
|---------|--------|---------------------|----------------|-----|--------|
| YT-3411 | 100    | 75                  | 1.0            | 8   | 25/250 |



| YATO    | L (mm) | working length (mm) | thickness (mm) | TPI |        |
|---------|--------|---------------------|----------------|-----|--------|
| YT-3412 | 75     | 50                  | 1.0            | 21  | 25/250 |



| YATO    | L (mm) | working length (mm) | thickness (mm) | TPI |        |
|---------|--------|---------------------|----------------|-----|--------|
| YT-3413 | 75     | 50                  | 1.0            | 12  | 25/250 |



| YATO    | L (mm) | working length (mm) | thickness (mm) | TPI |        |
|---------|--------|---------------------|----------------|-----|--------|
| YT-3414 | 75     | 50                  | 1.0            | 32  | 25/250 |



| YATO    | L (mm) | working length (mm) | thickness (mm) | TPI   |        |
|---------|--------|---------------------|----------------|-------|--------|
| YT-3415 | 100    | 75                  | 1.0            | 24-10 | 25/250 |

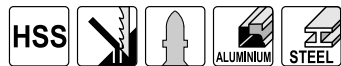

| YATO    | L (mm) | working length (mm) | thickness (mm) | TPI |        |
|---------|--------|---------------------|----------------|-----|--------|
| YT-3416 | 130    | 106                 | 1.0            | 21  | 25/250 |



| YATO    | L (mm) | working length (mm) | thickness (mm) | TPI  |        |
|---------|--------|---------------------|----------------|------|--------|
| YT-3417 | 130    | 106                 | 1.27           | 10-5 | 25/250 |

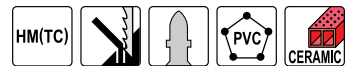

| YATO    | L (mm) | working length (mm) | thickness (mm) | TPI |        |
|---------|--------|---------------------|----------------|-----|--------|
| YT-3421 | 75     | 50                  | 1.2            | -   | 25/250 |



GB Jig saw blades CZ Pilový list do přímočaré pily I Scalpelli per il seghetto  
 D Stichsägeblätter H Dekopirlap E Recambio sierra de calar  
 PL Brzeszczyły do wyrzynarki RO Lama fierastrau pendular CN 曲线锯条  
 RUS Полотно для электр. станка F Lames à scie sauteuse

BLISTER  
CARD



5  
PCS

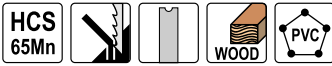

| YATO    | L (mm) | working length (mm) | thickness (mm) | TPI | Box    |
|---------|--------|---------------------|----------------|-----|--------|
| YT-3430 | 91.5   | 74.5                | 1.3            | 10  | 25/250 |



| YATO    | L (mm) | working length (mm) | thickness (mm) | TPI | Box    |
|---------|--------|---------------------|----------------|-----|--------|
| YT-3431 | 91.5   | 74.5                | 1.2            | 8   | 25/250 |



| YATO    | L (mm) | working length (mm) | thickness (mm) | TPI | Box    |
|---------|--------|---------------------|----------------|-----|--------|
| YT-3432 | 91.5   | 74.5                | 1.3            | 6   | 25/250 |



| YATO    | L (mm) | working length (mm) | thickness (mm) | TPI | Box    |
|---------|--------|---------------------|----------------|-----|--------|
| YT-3433 | 91.5   | 74.5                | 1.3            | 10  | 25/250 |



| YATO    | L (mm) | working length (mm) | thickness (mm) | TPI  | Box    |
|---------|--------|---------------------|----------------|------|--------|
| YT-3434 | 108    | 91                  | 1.3            | 12-8 | 25/250 |



| YATO    | L (mm) | working length (mm) | thickness (mm) | TPI | Box    |
|---------|--------|---------------------|----------------|-----|--------|
| YT-3435 | 100    | 83                  | 1.27           | 6   | 25/250 |



| YATO    | L (mm) | working length (mm) | thickness (mm) | TPI | Box    |
|---------|--------|---------------------|----------------|-----|--------|
| YT-3440 | 70     | 53                  | 1.0            | 21  | 25/250 |



| YATO    | L (mm) | working length (mm) | thickness (mm) | TPI | Box    |
|---------|--------|---------------------|----------------|-----|--------|
| YT-3441 | 70     | 53                  | 1.0            | 12  | 25/250 |



| YATO    | L (mm) | working length (mm) | thickness (mm) | TPI | Box    |
|---------|--------|---------------------|----------------|-----|--------|
| YT-3442 | 70     | 53                  | 1.0            | 36  | 25/250 |

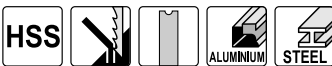

| YATO    | L (mm) | working length (mm) | thickness (mm) | TPI   | Box    |
|---------|--------|---------------------|----------------|-------|--------|
| YT-3443 | 91.5   | 74.5                | 1.0            | 21-16 | 25/250 |



| YATO    | L (mm) | working length (mm) | thickness (mm) | TPI  | Box    |
|---------|--------|---------------------|----------------|------|--------|
| YT-3444 | 127    | 110                 | 1.2            | 10-5 | 25/250 |

GB Jig saw blades CZ Pilový list do přímočaré pily I Scalpelli per il seghetto  
 D Stichsägeblätter H Dekopirlap E Recambio sierra de calar  
 PL Brzeszczyły do wyrzynarki RO Lama fierastrau pendular CN 曲线锯条  
 RUS Полотно для электр. станка F Lames à scie sauteuse

BLISTER  
CARD



5  
PCS



| YATO    | L (mm) | working length (mm) | thickness (mm) | TPI | Box    |
|---------|--------|---------------------|----------------|-----|--------|
| YT-3404 | 100    | 75                  | 1.3            | 10  | 25/250 |
| YT-3403 | 100    | 75                  | 1.3            | 6   |        |
| YT-3445 | 100    | 75                  | 1.27           | 10  |        |
| YT-3445 | 75     | 50                  | 1.0            | 32  |        |
| YT-3445 | 75     | 57                  | 1.0            | 12  |        |

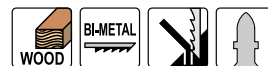

| YATO    | L (mm) | working length (mm) | thickness (mm) | TPI | Box    |
|---------|--------|---------------------|----------------|-----|--------|
| YT-3414 | 70     | 53                  | 1.0            | 21  | 25/250 |



| YATO    | L (mm) | working length (mm) | thickness (mm) | TPI | Box    |
|---------|--------|---------------------|----------------|-----|--------|
| YT-3445 | 100    | 75                  | 1.3            | 10  | 25/250 |
|         | 100    | 75                  | 1.3            | 6   |        |
|         | 100    | 75                  | 1.27           | 10  |        |
|         | 75     | 50                  | 1.0            | 32  |        |
|         | 75     | 57                  | 1.0            | 12  |        |

GB Half-moon saw blade for oscillating multitool HSS  
 D Rundes Sägeblatt HSS für ein Multifunktionswerkzeug  
 PL Brzeszczot okrągły HSS do narzędzia wielofunkcyjnego  
 RUS Дисковое полотно HSS для многофункционального инструмента  
 CZ Segmentový pilový list HSS pro multifunkční nářadí  
 H HSS kör keresztmetszetű fűrészlap multifunkciós szerszámhoz  
 RO Lamă rotundă HSS pt. unealta multifuncțională  
 F lame segment HSS pour outil multifonction  
 I Lama di sega circolare per lo strumento multi-funzione HSS  
 E Hoja redonda HSS para herramienta multifuncional  
 CN 高速钢半圆形锯片

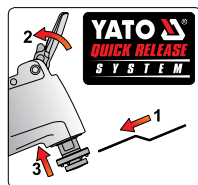

88 mm

HSS

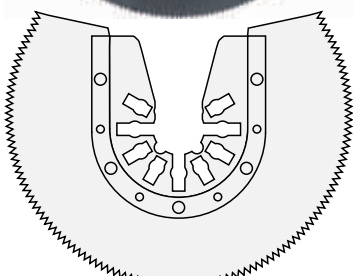

88 mm

for / dla: YT-82220

DOUBLE BLISTER

YATO  
YT-34680

5/100

• application:  
wood, plastic, soft metal, plaster  
• zastosowanie:  
drewno, plastik, miękki metal, gips

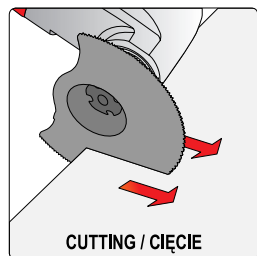

CUTTING / CIĘCIE

GB Half-moon saw blade for oscillating multitool HCS  
 D Rundes Sägeblatt HCS für ein Multifunktionswerkzeug  
 PL Brzeszczot okrągły HCS do narzędzia wielofunkcyjnego  
 RUS Дисковое полотно HCS для многофункционального инструмента  
 CZ Segmentový pilový list HCS pro multifunkční nářadí  
 H HCS kör keresztmetszetű fűrészlap multifunkciós szerszámhoz  
 RO Lamă rotundă HCS pt. unealta multifuncțională  
 F lame segment HCS pour outil multifonction  
 I Lama di sega circolare per lo strumento multi-funzione HCS  
 E Hoja redonda HCS para herramienta multifuncional  
 CN 高碳钢扇形锯片

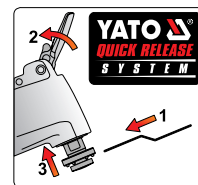

88 mm

HCS

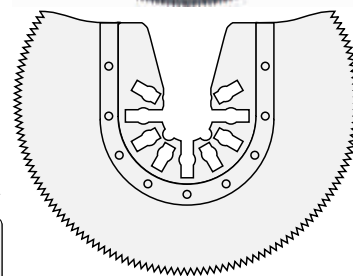

88 mm

for / dla: YT-82220

DOUBLE BLISTER

YATO  
YT-34681

5/100

• application:  
wood, plastic, soft metal, plaster  
• zastosowanie:  
drewno, plastik, miękki metal, gips

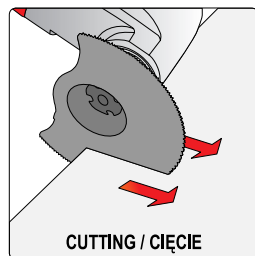

CUTTING / CIĘCIE

10

GB Brazed carbide d-shape blade for oscillating multitool HM  
 D Rundes Sägeblatt HM für ein Multifunktionswerkzeug  
 PL Brzeszczot okrągły HM do narzędzia wielofunkcyjnego  
 RUS Дисковое полотно HM для многофункционального инструмента  
 CZ Segmentový pilový list HM pro multifunkční nářadí  
 H HM kör keresztmetszetű fűrészlap multifunkciós szerszámhoz  
 RO Lamă rotundă HM pt. unealta multifuncțională  
 F lame segment HM pour outil multifonction  
 I Lama di sega circolare per lo strumento multi-funzione HM  
 E Hoja redonda HM para herramienta multifuncional  
 CN D形合金磨片

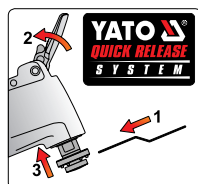

70 mm

HM

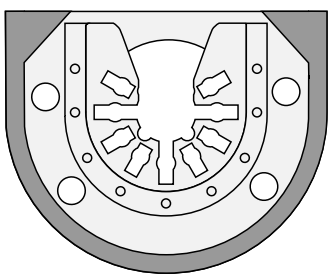

70 mm

for / dla: YT-82220

DOUBLE BLISTER

YATO  
YT-34682

5/100

• application:  
concrete, ceramic materials,  
epoxy resin, fibreglass  
• zastosowanie:  
beton, materiały ceramiczne,  
żywica epoksydowa, włókno szklane

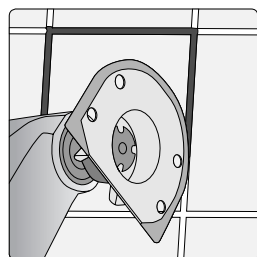

GB Plunge cutting saw blade for oscillating multitool BIM  
 D Tiefenmesser BIM für ein Multifunktionswerkzeug  
 PL Brzeszczot wglębny BIM do narzędzia wielofunkcyjnego  
 RUS Сабельное полотно BIM для многофункционального инструмента  
 CZ Pilový list BIM na ponorné řezy pro multifunkční nářadí  
 H BIM merülő fűrészlap multifunkciós szerszámhoz  
 RO Lamă de adâncime BIM pt. unealta multifuncțională  
 F lame scie plongeante BIM pour outil multifonction  
 I Lama per tagli dal pieno BIM  
 E Hoja para cortes profundos BIM para herramienta multifuncional  
 CN 双金属直锯片

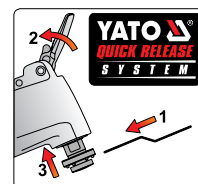

10 mm

BIM

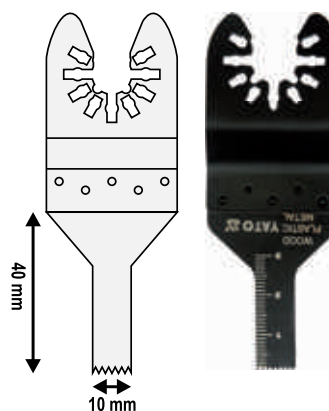

40 mm

10 mm

• application:  
wood, plastic, metal, plaster,  
epoxy resin  
• zastosowanie:  
drewno, plastik, metal, gips,  
żywica epoksydowa

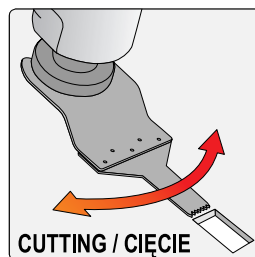

CUTTING / CIĘCIE

for / dla: YT-82220

DOUBLE BLISTER

YATO  
YT-34683

5/100



GB Plunge cutting saw blade for oscillating multitool  
D Tiefenmesser BIM für ein Multifunktionswerkzeug  
PL Brzeszczot wgłębny BIM do narzędzia wielofunkcyjnego  
RUS Сабельное полотно BIM для многофункционального инструмента  
CZ Pilový list BIM na ponorné řezy pro multifunkční nářadí  
H BIM merülő fűrészlap multifunkciós szerszámhoz  
RO Lamă de adâncime BIM pt. unealta multifuncțională  
F Lame scie plongeante BIM pour outil multifonction  
I Lama per tagli dal pieno BIM  
E Hoja para cortes profundos BIM para herramienta multifuncional  
CN 双金属直锯片

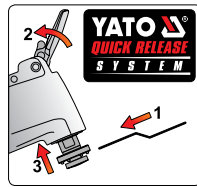

3  
PCS  
28.5  
mm  
BIM

- application: wood, plastic, metal, plaster, epoxy resin
- zastosowanie: drewno, plastik, metal, gips, żywica epoksydowa

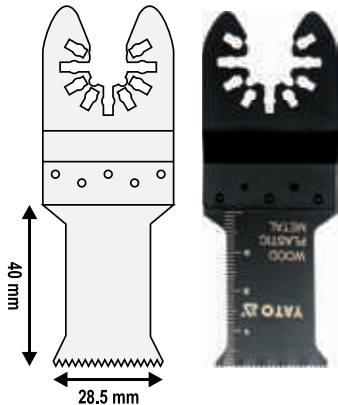

for / dla: YT-82220

DOUBLE BLISTER



**YATO**  
YT-34684 5/100

CUTTING / CIĘCIE

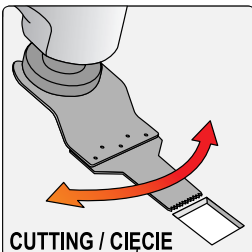

GB Plunge cutting saw blade for oscillating multitool HCS  
D Tiefenmesser HCS für ein Multifunktionswerkzeug  
PL Brzeszczot wgłębny HCS do narzędzia wielofunkcyjnego  
RUS Сабельное полотно HCS для многофункционального инструмента  
CZ Pilový list HCS na ponorné řezy pro multifunkční nářadí  
H HCS merülő fűrészlap multifunkciós szerszámhoz  
RO Lamă de adâncime HCS pt. unealta multifuncțională  
F Lame scie plongeante HCS pour outil multifonction  
I Lama per tagli dal pieno HCS  
E Hoja para cortes profundos HCS para herramienta multifuncional  
CN 高碳钢直锯片

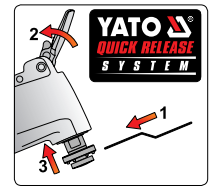

3  
PCS  
34  
mm  
HCS

- application: wood, plastic, plaster
- zastosowanie: drewno, plastik, gips

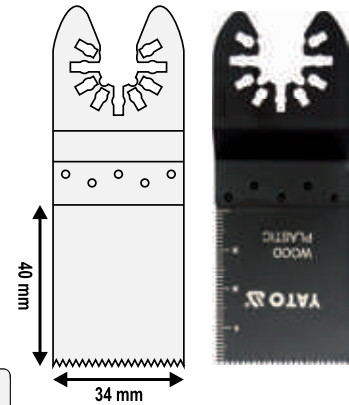

for / dla: YT-82220

DOUBLE BLISTER



**YATO**  
YT-34685 5/100

CUTTING / CIĘCIE

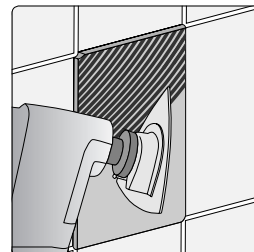

GB Plunge cutting saw blade for oscillating multitool  
D Tiefenmesser BIM für ein Multifunktionswerkzeug  
PL Brzeszczot wgłębny BIM do narzędzia wielofunkcyjnego  
RUS Сабельное полотно BIM для многофункционального инструмента  
CZ Pilový list BIM na ponorné řezy pro multifunkční nářadí  
H BIM merülő fűrészlap multifunkciós szerszámhoz  
RO Lamă de adâncime BIM pt. unealta multifuncțională  
F Lame scie plongeante BIM pour outil multifonction  
I Lama per tagli dal pieno BIM  
E Hoja para cortes profundos BIM para herramienta multifuncional  
CN 双金属直锯片

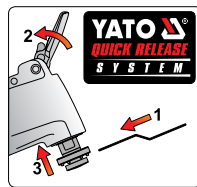

20  
mm  
BIM

- application: wood, plastic, metal, plaster, epoxy resin
- zastosowanie: drewno, plastik, metal, gips, żywica epoksydowa

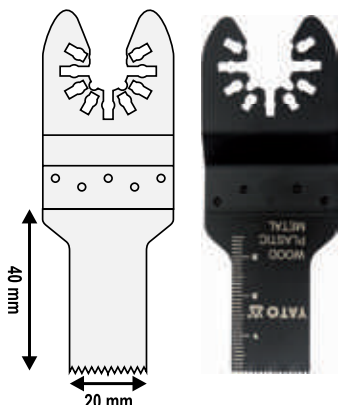

for / dla: YT-82220

DOUBLE BLISTER



**YATO**  
YT-34686 5/100

CUTTING / CIĘCIE

GB Brazed carbide triangular rasp for oscillating multitool  
D Dreieckige Raspel für ein Multifunktionswerkzeug  
PL Tarnik trójkątny do narzędzia wielofunkcyjnego  
RUS Треугольный рашпиль для многофункционального инструмента  
CZ Trojúhelníková brusná deska pro multifunkční nářadí  
H Háromszög keresztmetszetű reszelő multifunkciós szerszámhoz  
RO Raspel triunghiular pt. unealta multifuncțională  
F Plateau de ponçage à concretion carbure pour outil multifonction  
I Raspa in metallo duro forma triangolare multi-funzione  
E Escofina triangular para herramienta multifuncional  
CN 三角形嵌合金磨片



80  
mm  
HM

- application: concrete, ceramic materials
- zastosowanie: beton, materiały ceramiczne

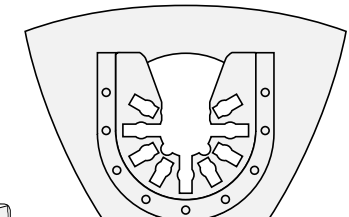

for / dla: YT-82220

DOUBLE BLISTER



**YATO**  
YT-34687 5/100

- GB Short scraper for oscillating multitool
- D Schaber für ein Multifunktionswerkzeug
- PL Skrobak do narzędzia wielofunkcyjnego
- RUS Скребок для многофункционального инструмента
- CZ Škrabka pro multifunkční nářadí
- H Kaparó multifunkciós szerszámhoz
- RO Răzuitor pt. unealta multifuncțională
- F Spatule pour outil multifonction
- I Raschietto oscillante multifunzione adatto
- E Raspador para herramienta multifuncional
- CN 弯刮刀



52 mm

HCS

• application:  
paint, adhesives,  
sealing compounds

• zastosowanie:  
farby, kleje, masy uszczelniające

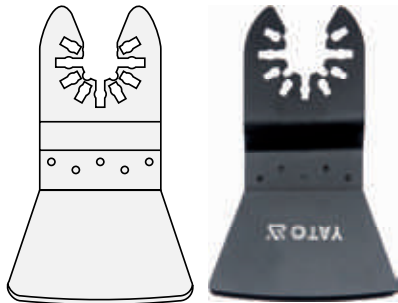
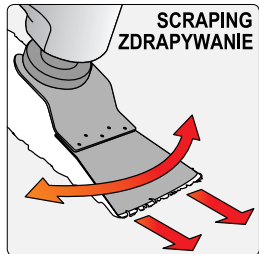

52 mm

for / dla: YT-82220

YATO  
YT-34688

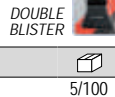

- GB Triangular eva sanding pad for oscillating multitool
- D Schleiffluß für ein Multifunktionswerkzeug
- PL Stopa szlifierska do narzędzia wielofunkcyjnego
- RUS Шлифовальная насадка для многофункционального инструмента
- CZ Brusný nástavec pro multifunkční nářadí
- H Csiszoló talp multifunkciós szerszámhoz
- RO Pcior de sablare pt. unealta multifuncțională
- F Plateau de ponçage pour outil multifonction
- I Tasso di smerigliatrice multifunzionale
- E Pie de rectificación para herramienta multifuncional
- CN 三角砂盘



90 mm

EVA

• application:  
wood, metal, plaster

• zastosowanie:  
drewno, metal, gips

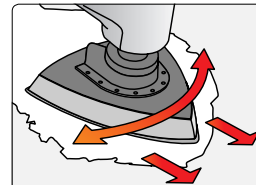

90 mm

for / dla: YT-82220

YATO  
YT-34689



10

- GB Triangular sand paper for oscillating multitool
- D Schleifpapier für ein Multifunktionswerkzeug
- PL Papier ścierny do narzędzia wielofunkcyjnego
- RUS Шлифовальная бумага для многофункционального инструмента
- CZ Brusné plátno pro multifunkční nářadí
- H Csiszolópapír multifunkciós szerszámhoz
- RO Hârtie abrazivă pt. unealta multifuncțională
- F Feuilles abrasives pour outil multifonction
- I Carta abrasiva per utensile multifunzione
- E Papel de lija para herramienta multifuncional
- CN 三角砂纸



10 mm

• application:  
wood, metal, plaster

• zastosowanie:  
drewno, metal, gips

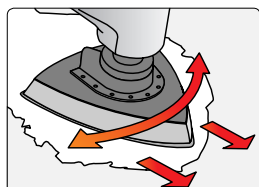

90 mm

for / dla: YT-82220

YATO  
YT-34690



- GB Accessories set for oscillating multitool
- D Zubehörsatz für ein Multifunktionswerkzeug
- PL Zestaw akcesoriów do narzędzia wielofunkcyjnego
- RUS Набор принадлежностей для многофункционального инструмента
- CZ Souprava příslušenství pro multifunkční nářadí
- H Tartozék szett multifunkciós szerszámhoz
- RO Set de accesorii pt. unealta multifuncțională
- F Set d'accessoires pour outil multifonction
- I Set di accessori per utensile multifunzione
- E Juego de accesorios para herramienta multifuncional
- CN 三件套：双金属直锯片 + 高碳钢直锯片 + 高速钢半圆形锯片

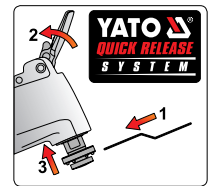

3 PCS

HSS

HCS

BIM

• application:  
wood, plastic,  
metal, plaster,  
epoxy resin

• zastosowanie:  
drewno, plastik,  
metal, gips,  
żywica epoksydowa

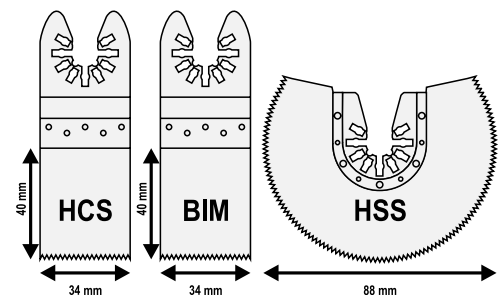
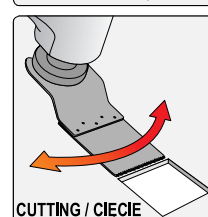
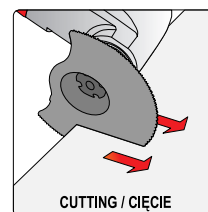

40 mm

34 mm

40 mm

34 mm

88 mm

for / dla: YT-82220

YATO  
YT-34691





GB Steel wire brush  
D Stahldrahtbürste  
PL Szczotka druciana  
RUS Щетка стальная



CZ Drátěný kartáč  
H Drotkefe  
RO Perie de sârmă



F Brosse de fil en laiton  
I Spazzola metallica

E Cepillo de acero  
CN 钢丝刷

ZINC  
PLATED  
WIRES



| YATO  | rows / rzędy |  |
|--|--------------|---|
| YT-6353  | 3            | 12/120  |
| YT-6354  | 4            | 12/120  |
| YT-6355  | 5            | 12/120  |
| YT-6356  | 6            | 12/120  |

| YATO  | rows / rzędy |  |
|--|--------------|---|
| YT-6358  | 4            | 12/72   |
| YT-6359  | 5            | 12/72   |
| YT-6360  | 6            | 12/72   |

GB Steel wire brush  
D Stahldrahtbürste  
PL Szczotka druciana  
RUS Щетка стальная

CZ Drátěný kartáč  
H Drotkefe  
RO Perie de sârmă

F Brosse de fil en laiton  
I Spazzola metallica

E Cepillo de acero  
CN 钢丝刷

TIED  
ON CARD



STEEL  
STAL

STEEL  
STAL

| YATO  | rows / rzędy | L (mm) |  |
|--|--------------|--------|---|
| YT-6330  | 3            | 340    | 12/72   |

| YATO  | rows / rzędy | L (mm) |  |
|--|--------------|--------|---|
| YT-6331  | 3            | 340    | 12/72   |



STEEL  
STAL

STEEL  
STAL



| YATO  | rows / rzędy | L (mm) |  |
|--|--------------|--------|---|
| YT-6332  | 4            | 260    | 12/72   |



| YATO  | rows / rzędy | L (mm) |  |
|--|--------------|--------|---|
| YT-6333  | 4            | 290    | 12/72   |



STEEL  
STAL

STAINLESS  
STEEL  
STAL  
NIERZĘDZWA

| YATO  | rows / rzędy | L (mm) |  |
|--|--------------|--------|---|
| YT-6334  | 6            | 180x65 | 12/60   |

| YATO  | rows / rzędy | L (mm) |  |
|--|--------------|--------|---|
| YT-6335  | 3            | 340    | 12/72   |



STAINLESS  
STEEL  
STAL  
NIERZĘDZWA

STAINLESS  
STEEL  
STAL  
NIERZĘDZWA



| YATO  | rows / rzędy | L (mm) |  |
|--|--------------|--------|---|
| YT-6336  | 3            | 340    | 12/72   |



| YATO  | rows / rzędy | L (mm) |  |
|--|--------------|--------|---|
| YT-6337  | 3            | 180    | 24/144  |



STAINLESS  
STEEL  
STAL  
NIERZĘDZWA

STAINLESS  
STEEL  
STAL  
NIERZĘDZWA



| YATO  | rows / rzędy | L (mm) |  |
|--|--------------|--------|---|
| YT-6338  | 4            | 260    | 12/72   |

| YATO  | rows / rzędy | L (mm) |  |
|--|--------------|--------|---|
| YT-6339  | 4            | 290    | 12/72   |



STAINLESS  
STEEL  
STAL  
NIERZĘDZWA

BRASS  
MOSIĄDZ

| YATO  | rows / rzędy | L (mm) |  |
|--|--------------|--------|---|
| YT-6340  | 5            | 180    | 24/120  |

| YATO  | rows / rzędy | L (mm) |  |
|--|--------------|--------|---|
| YT-6341  | 3            | 340    | 12/72   |

GB Steel wire brush  
 D Stahldrahtbürste  
 PL Szczotka druciana  
 RUS Щетка стальная

CZ Drátěný kartáč  
 H Drótkefe  
 RO Perie de sârmă

F Brosse de fil en laiton  
 I Spazzola metallica  
 E Cepillo de acero  
 CN 钢丝刷

BRASS  
 MOSIÁDZ



| YATO    | rows / rzędy | L (mm) |       |
|---------|--------------|--------|-------|
| YT-6342 | 3            | 340    | 12/72 |

BRASS  
 MOSIÁDZ



| YATO    | rows / rzędy | L (mm) |        |
|---------|--------------|--------|--------|
| YT-6343 | 3            | 180    | 24/144 |

BRASS  
 MOSIÁDZ



| YATO    | rows / rzędy | L (mm) |       |
|---------|--------------|--------|-------|
| YT-6344 | 4            | 260    | 12/72 |

BRASS  
 MOSIÁDZ



| YATO    | rows / rzędy | L (mm) |       |
|---------|--------------|--------|-------|
| YT-6345 | 4            | 290    | 12/72 |

BRASS  
 MOSIÁDZ



| YATO    | rows / rzędy | L (mm) |        |
|---------|--------------|--------|--------|
| YT-6346 | 5            | 180    | 24/120 |

BRASS  
 MOSIÁDZ



| YATO    | rows / rzędy | L (mm) |       |
|---------|--------------|--------|-------|
| YT-6347 | 6            | 180x65 | 12/60 |

10

NYLON



| YATO    | rows / rzędy | L (mm) |       |
|---------|--------------|--------|-------|
| YT-6348 | 4            | 290    | 12/72 |

NYLON



| YATO    | rows / rzędy | L (mm) |        |
|---------|--------------|--------|--------|
| YT-6349 | 5            | 180    | 24/120 |

NYLON



| YATO    | rows / rzędy | L (mm) |       |
|---------|--------------|--------|-------|
| YT-6350 | 6            | 180x65 | 12/60 |

GB Plastic handle wire brush set  
 D Bürstensatz  
 PL Komplet szczotek drucianych  
 RUS Щетки - набор  
 CZ Drátěný kartáče  
 H Kefekészlet  
 RO Perii  
 F Set de brosses de fil en laiton

I Set di spazzole metalliche  
 E Juego de 3 cepillos  
 CN 钢丝刷组套



3 PCS  
 STAINLESS STEEL  
 DRUT ZE STALI  
 NIERDZEWNA  
 BRASS  
 MOSIÁDZ  
 NYLON

SLIDING  
 CARD

| YATO    | rows / rzędy | L (mm) |        |
|---------|--------------|--------|--------|
| YT-6351 | 3            | 180    | 24/144 |

GB Copper pipe internal brush  
 D Kupferrohr Innenbürste  
 PL Szczotka wewnętrzna do rur miedzianych  
 RUS Щетка для внутренней очистки труб  
 CZ Kartáč vnitřní na měděné trubky  
 H Rézcső belső tisztító kefe

RO Perii de interior pt. tevi de cupru  
 F Brosse aux tubes en cuivre  
 I Spazzola per il rame interno  
 E Cepillo para limpieza de tubos de cobre  
 CN 管子刷

STAINLESS  
 STEEL WIRE  
 DRUT ZE STALI  
 NIERDZEWNE



| YATO     | Ø (mm) |        |
|----------|--------|--------|
| YT-63701 | 15     | 12/120 |
| YT-63702 | 18     | 12/120 |
| YT-63703 | 22     | 12/120 |
| YT-63704 | 28     | 12/120 |

GB Copper pipe brush 2 in 1  
 D 2-in-1 Kupferrohrbürste für Innen- und Außenreinigung  
 PL Szczotka do rur miedzianych 2 w 1  
 RUS Щетка для внутренней и внешней зачистки медных труб  
 CZ Kartáč vnitřní a vnější na měděné trubky

H Rézcső tisztító kefe 2 in 1  
 RO Perii pt. tevi de cupru 2 in 1  
 F Brosse aux tubes en cuivre  
 I Spazzola per il tubi di rame 2 in 1  
 E 2-en-1 cepillo para limpieza de tubos de cobre int. y ext  
 CN 2合1管子刷

STAINLESS  
 STEEL WIRE  
 DRUT ZE STALI  
 NIERDZEWNE



| YATO     | Ø (mm) |        |
|----------|--------|--------|
| YT-63705 | 15; 22 | 50/100 |

SLIDING  
 CARD



GB Cup brush with shaft  
D Stahldraht-Topfbürste  
PL Szczotka czolowa z trzpieniem  
RUS Щетка "чашка" со стержнем  
CZ Čelní kartáč drátěný se stopkou  
H Homlok drótkefe, nyéllal  
RO Perie frontală pt. bormasina  
F Brosse coupe avec gouppile  
I Spazzola a tazza  
E Cepillo de copa con mandril  
CN 钢丝轮

SLIDING  
CARD



∅ 6 mm



**INOX**



| YATO    | ∅ (mm) | R.P.M.max. |  |
|---------|--------|------------|---|
| YT-4750 | 75     | 4500       | 12/96   |

| YATO    | ∅ (mm) | R.P.M.max. |  |
|---------|--------|------------|---|
| YT-4751 | 75     | 4500       | 12/96   |

| YATO    | ∅ (mm) | R.P.M.max. |  |
|---------|--------|------------|---|
| YT-4752 | 75     | 6000       | 12/72   |

GB Cup brush with shaft set  
D Drahtbürste mit Einspannschaft  
PL Szczotki druciane z trzpieniem  
RUS Щетки проволочные со стержнем  
CZ Drátěný kartáč se stopkou  
H Drótkefe, csapos  
RO Perie de sârmă cu tijă  
F Set de brosses coupe avec gouppile  
I Spazzola metallica a disco  
E Cepillos de alambre con espiga  
CN 三件钢丝组套



SLIDING  
CARD



∅ 6 mm



| YATO    | ∅ (mm) | R.P.M.max. |  |
|---------|--------|------------|---|
| YT-4755 | 20     | 6000       | 12/60   |
|         | 50     | 7500       |   |
|         | 50     | 4500       |   |

GB Circular brush with shaft  
D Stahldraht-Scheibenbürste  
PL Szczotka tarczowa z trzpieniem  
RUS Щетка круговая со стержнем  
CZ Okružní kartáč drátěný se stopkou  
H Tarcás drótkefe, nyéllal  
RO Perie rotundă pt. bormasina  
F Brosse circulaire avec gouppile  
I Spazzola a disco  
E Cepillo redondo  
CN 钢丝轮

SLIDING  
CARD





∅ 6 mm



**INOX**



| YATO    | ∅ (mm) | R.P.M.max. |  |
|---------|--------|------------|---|
| YT-4757 | 100    | 4500       | 12/96   |

| YATO    | ∅ (mm) | R.P.M.max. |  |
|---------|--------|------------|---|
| YT-4758 | 100    | 4500       | 12/96   |

| YATO    | ∅ (mm) | R.P.M.max. |  |
|---------|--------|------------|---|
| YT-4759 | 75     | 20000      | 10/100  |

GB Circular brush  
D Stahldraht-Scheibenbürste  
PL Szczotka tarczowa z gwintem  
RUS Щетка круговая  
CZ Okružní kartáč drátěný  
H Tarcás drótkefe  
RO Perie rotundă pt. bormasina  
F Brosse circulaire avec filet  
I Spazzola conica  
E Cepillo redondo  
CN 钢丝轮

COLOR  
BOX



**M14**



**INOX**



| YATO    | ∅ (mm) | R.P.M.max. |  |
|---------|--------|------------|---|
| YT-4761 | 100    | 12500      | 8/64  |

| YATO    | ∅ (mm) | R.P.M.max. |  |
|---------|--------|------------|---|
| YT-4763 | 100    | 12500      | 8/64  |

| YATO    | ∅ (mm) | R.P.M.max. |  |
|---------|--------|------------|---|
| YT-4764 | 125    | 10000      | 8/48  |

GB Cup brush  
D Stahldraht-Topfbürste  
PL Szczotka czolowa z gwintem  
RUS Щетка "чашка"  
CZ Čelní kartáč drátěný  
H Homlok drótkefe  
RO Perie frontală  
F Brosse coupe avec filet  
I Spazzola conica  
E Cepillo de copa  
CN 钢丝轮

COLOR  
BOX





**M14**





**INOX**



| YATO    | ∅ (mm) | R.P.M.max. |  |
|---------|--------|------------|---|
| YT-4766 | 100    | 8500       | 4/32  |

| YATO    | ∅ (mm) | R.P.M.max. |  |
|---------|--------|------------|---|
| YT-4767 | 60     | 12500      | 10/80   |

| YATO    | ∅ (mm) | R.P.M.max. |  |
|---------|--------|------------|---|
| YT-4768 | 75     | 11000      | 6/36  |

| YATO    | ∅ (mm) | R.P.M.max. |  |
|---------|--------|------------|---|
| YT-4769 | 100    | 8500       | 4/16  |



GB Electrician's knife  
 D Montagemesser  
 PL Nóż składany monterski  
 RUS Нож складной

CZ Montážní nůž  
 H Szerelőkés  
 RO Cuțit pt. decablat  
 F Couteau d'électricien



I Coltello  
 E Cuchillo de montaje  
 CN 电工刀



SLIDING CARD  
  
**3CR13**  
**HRC 42-48**



**85 mm**  
**200 mm**

**75 mm**  
**190 mm**

|   |   |
|---|---|
| <b>YATO</b>  |  |
| YT-7600   | 6/96  |

|   |   |
|---|---|
| <b>YATO</b>  |  |
| YT-7601   | 6/96  |





GB Folding knife with bits  
 D Klappmesser  
 PL Nóż składany z bitami  
 RUS Нож складной  
 CZ Kapesní nůž

H Zsebkés  
 RO Briceag  
 F Couteau pince multifonction avec embouts

I Coltello pieghevole con punte  
 E Navaja  
 CN 旋具头折叠刀

BLISTER CARD  
  
**STAINLESS STEEL STAL**  
**NERZDZEWNA**  
  
  
**AI**  
  



 3, 4 mm;  
 PH1, PH2;  
 3, 4 mm;  
 T10, T20

|   |   |
|---|---|
| <b>YATO</b>  |  |
| YT-76031  | 4/40  |

10

GB Folding knife  
 D Klappmesser  
 PL Nóż składany  
 RUS Нож складной

CZ Kapesní nůž  
 H Zsebkés  
 RO Briceag  
 F Couteau pliant

I Coltello pieghevole  
 E Navaja  
 CN 折叠刀

SLIDING CARD  
  
**STAINLESS STEEL BLADE**  
**OSTRZE ZE STALI NERZDZEWNEJ**



**AI**

|   |   |
|---|---|
| <b>YATO</b>  |  |
| YT-76050  | 12/72   |



|   |   |
|---|---|
| <b>YATO</b>  |  |
| YT-76051  | 12/120  |



|   |   |
|---|---|
| <b>YATO</b>  |  |
| YT-76052  | 12/120  |



- |                  |                    |
|------------------|--------------------|
| GB Multi knife   | F Couteau          |
| D Klappmesser    | multifonction      |
| PL Nóż           | I Pinze universale |
| wielofunkcyjny   | E Navaja           |
| RUS Нож складной | CN 多功能折叠刀          |
| CZ Kapesní nůž   |                    |
| H Zsebkés        |                    |
| RO Briceag       |                    |

7  
PCS

STAINLESS  
STEEL  
STAL  
NIEŹYWIENNA

AI



SLIDING  
CARD

**YATO** 

YT-76030 

12/96

- |                  |                 |                    |
|------------------|-----------------|--------------------|
| GB Multi knife   | CZ Kapesní nůž  | I Pinze universale |
| D Klappmesser    | H Zsebkés       | E Navaja           |
| PL Narzędzie     | RO Briceag      | CN 多功能折叠刀          |
| wielofunkcyjne   | F Couteau pince |                    |
| RUS Нож складной | multifonction   |                    |

BLISTER  
CARD





9  
PCS

STAINLESS  
STEEL  
STAL  
NIEŹYWIENNA



AI

**YATO** 

YT-76040 

10/100



AI

**YATO** 

YT-76041 

12/48



AI

**YATO** 

YT-76042 

12/48



**YATO** 

YT-76043 

6/36

- GB Cutter knife  
 D Universalmesser  
 PL Nożyk z ostrzem trapezowym  
 RUS Ножи универсальные  
 CZ Univerzální nůž  
 H Univerzális kés
- RO Cuțit universal  
 F Couteau lames trapésoïdale  
 I Coltellino con lama trapezoidale  
 E Cutter con filo trapezoidal  
 CN 实用刀



**x3** **SK5**



**SK2** **x5** **LOCK** **ZINC ALLOY TPR**



|             |           |      |
|-------------|-----------|------|
| <b>YATO</b> | (mm)      |      |
| YT-7520     | 61x33x0.5 | 6/48 |

|             |           |      |
|-------------|-----------|------|
| <b>YATO</b> | (mm)      |      |
| YT-7523     | 61x33x0.5 | 6/48 |

- GB Cutter knife  
 D Universalmesser  
 PL Nożyk z ostrzem trapezowym  
 RUS Ножи универсальные  
 CZ Univerzální nůž  
 H Univerzális kés
- RO Cuțit universal  
 F Couteau lames trapésoïdale  
 I Coltellino con lama trapezoidale  
 E Cutter con filo trapezoidal  
 CN 实用刀

**x5** **SK5**



|             |           |       |
|-------------|-----------|-------|
| <b>YATO</b> | (mm)      |       |
| YT-7532     | 61x33x0.5 | 12/72 |

|             |           |       |
|-------------|-----------|-------|
| <b>YATO</b> | (mm)      |       |
| YT-7534     | 61x33x0.5 | 12/72 |

- GB Utility knife  
 D Universalmesser  
 PL Nożyk z łamanym ostrzem  
 RUS Нож универсальный  
 CZ Nůž na tapety  
 H Tapétaolló
- RO Cuțitaș pt. tapet  
 F Cutter à lames sécables  
 I Taglierino  
 E Cuchillo para papel de empapelar  
 CN 美工刀



**SK5**



**x4**



**x5** **LOCK**

|             |       |        |
|-------------|-------|--------|
| <b>YATO</b> | (mm)  |        |
| YT-7500     | 9x0.4 | 24/240 |

|             |        |        |
|-------------|--------|--------|
| <b>YATO</b> | (mm)   |        |
| YT-7501     | 18x0.4 | 12/120 |



**x3** **AI HANDLE**



**x3** **LOCK**

|             |        |       |
|-------------|--------|-------|
| <b>YATO</b> | (mm)   |       |
| YT-7571     | 9x0.4  | 20/80 |
| YT-7581     | 18x0.4 | 20/80 |

|             |        |      |
|-------------|--------|------|
| <b>YATO</b> | (mm)   |      |
| YT-7510     | 25x0.7 | 6/48 |



- GB Utility knife  
D Universalmesser  
PL Nożyk z łamanym ostrzem  
RUS Нож универсальный  
CZ Nůž na tapety  
H Tapétaolló
- RO Cutițaș pt. tapet  
F Cutter à lames sécables  
I Taglierino  
E Cuchillo para papel de empapelar  
CN 美工刀

SLIDING  
CARD



SK2



ABS

| YATO    | /// (mm) |        |
|---------|----------|--------|
| YT-7511 | 9x0.4    | 24/288 |
| YT-7512 | 18x0.5   | 12/96  |

| YATO    | /// (mm) |        |
|---------|----------|--------|
| YT-7504 | 9x0.4    | 24/240 |
| YT-7505 | 18x0.5   | 24/240 |



LOCK ABS  
TPR

x3 LOCK ABS  
TPR

| YATO    | /// (mm) |        |
|---------|----------|--------|
| YT-7506 | 9x0.4    | 24/240 |
| YT-7507 | 18x0.5   | 12/144 |

| YATO    | /// (mm) |        |
|---------|----------|--------|
| YT-7503 | 18x0.5   | 12/144 |

- GB Spare blades  
D Abbrechklingen  
PL Ostrza zapasowe  
RUS Лезвия для универсальных  
ножей  
CZ Lomené ostří náhradní  
H Törhető tartalékpenge
- RO Lame de rezervă rupte  
F Lame sécables  
pour le cutter  
I Lame di ricambio  
E Filo partido de recambio  
CN 美工刀刀片
- PLASTIC  
BOX  
& SLIDING  
CARD
- 10  
PCS
- SK5

- GB Spare blades  
D Abbrechklingen  
PL Ostrza zapasowe  
RUS Лезвия для универсальных  
ножей  
CZ Lomené ostří náhradní  
H Törhető tartalékpenge
- RO Lame de rezervă rupte  
F Lame sécables  
pour le cutter  
I Lame di ricambio  
E Filo partido de recambio  
CN 美工刀刀片
- PLASTIC  
BOX  
& SLIDING  
CARD
- 10  
PCS
- SK2

10



| YATO    | /// (mm) |      |
|---------|----------|------|
| YT-7530 | 25x0.7   | 6/48 |



| YATO    | /// (mm) |        |
|---------|----------|--------|
| YT-7524 | 9x0.4    | 24/240 |
| YT-7525 | 18x0.5   | 24/144 |



| YATO    | /// (mm)  |        |
|---------|-----------|--------|
| YT-7531 | 61x33x0.5 | 24/144 |



| YATO    | /// (mm) |        |
|---------|----------|--------|
| YT-7528 | 9x0.4    | 24/144 |
| YT-7529 | 18x0.5   | 24/144 |



| YATO    | /// (mm)  |        |
|---------|-----------|--------|
| YT-7527 | 61x33x0.5 | 24/144 |

- GB Electrician scissors  
D Elektrische Schere  
PL Nożyczki dla elektryków  
RUS Ножницы универсальные  
CZ Elektrické nůžky  
H Univerzális olló
- RO Foarfece - electrician  
F Ciseaux pour electriciens  
I Forbici per elettricisti  
E Tijeras eléctricos  
CN 电工剪
- 140  
mm
- STAINLESS  
STEEL  
BLADE  
NERZEWIENIA
- HRC  
52-56

- GB Scissors  
D Haushaltsschere  
PL Nożyczki  
RUS Ножницы  
CZ Nůžky  
H Olló
- RO Foarfece  
F Ciseaux  
I Forbici  
E Tijeras  
CN 剪刀
- STAINLESS  
STEEL BLADE  
OSTRZE  
ZE STALI  
NERZEWIENIA



SLIDING  
CARD



| YATO    | L (mm) |        |
|---------|--------|--------|
| YT-1974 | 140    | 12/120 |

| YATO     | L (mm) |        |
|----------|--------|--------|
| YT-19763 | 170    | 12/120 |
| YT-19764 | 190    | 12/120 |
| YT-19765 | 215    | 12/120 |
| YT-19766 | 245    | 12/120 |
| YT-19767 | 300    | 12/120 |

- GB Glass oil cutter  
 D Glasschneider  
 PL Nóż olejowy do szkła  
 RUS Стеклопоз масляный  
 CZ Rezák na sklo
- H Olajkés üveghez  
 RO Diamant pt. taiat stricla cu ulei  
 F Couteau à l'huile pour verre  
 I Taglia vetro con serbatoio olio
- E Cuchillo de aceite para cristalinación  
 CN 玻璃割刀

SLIDING CARD

**YD05**  
 UNICUTTER CARBIDE TIP  
 OIL-PAZ 2-VEGSEKES  
 VÖLJELVÁRÓ

**HRA**  
 92.5-93



|             |        |       |
|-------------|--------|-------|
| <b>YATO</b> | L (mm) |       |
| YT-7560     | 177    | 6/120 |

|             |        |       |
|-------------|--------|-------|
| <b>YATO</b> | L (mm) |       |
| YT-7561     | 178    | 6/120 |

- GB Scriber for glass, ceramics and metal  
 D Reißnadel für Glas, Keramik und Metall  
 PL Rysik do szkła, ceramiki i metalu  
 RUS Штихель для стекла, керамика и металла
- CZ Rýsovací jehla na sklo, keramiku a kov  
 H Karctű üveghez, kerámiához és fémhez  
 RO Ac de trasat pt. sticlă, ceramică și metal  
 F Stylet verre, céramique et métal
- I Penna di vetro ceramica metallo  
 E Trazador para vidrio, cerámica y metal  
 CN 划线器

SLIDING CARD

**140 mm**

**YG6X**  
 UNICUTTER CARBIDE TIP  
 ÖSTRIK 2-VEGSEKES  
 VÖLJELVÁRÓ



|             |        |       |
|-------------|--------|-------|
| <b>YATO</b> | L (mm) |       |
| YT-3740     | 140    | 6/240 |

- GB Double edge trimmer  
 D Kantentrimmer  
 PL Dwustronny nóż do odcinania oklein  
 RUS Двусторонний нож для мебельной пленки  
 CZ Orezávací nuž na hrany lamina  
 H Kétélű vágó
- RO Rindea pt. finisaje  
 F Couteau reversible pour bois de placage  
 I Doppio coltello  
 E Cuchillo de doble filo para cortar chapas de madera  
 CN 双边刨子

**13-25 mm**

ONE SIDE CUTTING  
 BOTH SIDE CUTTING

**SK5**



SLIDING CARD

|             |      |
|-------------|------|
| <b>YATO</b> |      |
| YT-5710     | 6/48 |

- GB Profile gauge  
 D Profilmuster  
 PL Wzornik profili
- RUS Шаблон профилей  
 CZ Profilová šablona  
 H Profilsablón
- RO Șablon profile  
 F Jauges d'épaisseurs métriques
- I Profilato  
 E Plantilla de perfiles  
 CN 轮廓仪

SLIDING CARD

**44 mm**

**1.5 mm**



|             |        |       |
|-------------|--------|-------|
| <b>YATO</b> | L (mm) |       |
| YT-3735     | 125    | 24/72 |

|             |        |       |
|-------------|--------|-------|
| <b>YATO</b> | L (mm) |       |
| YT-3736     | 260    | 10/40 |

- GB Punch set  
 D Lederlocherset  
 PL Przebijaki do skóry  
 RUS Набор пробойников для кожи  
 CZ Sada průbojníků na kůži  
 H Bőryukasztó készlet  
 RO Set producele  
 F Kit de perçoirs à cuir  
 I Set di punzoni  
 E Juego de perforar en piel  
 CN 冲孔器套装



POUCH & COLOR BOX



**9**  
PCS

**15**  
PCS

|             |  |    |
|-------------|--|----|
| <b>YATO</b> | size / rozmiar                               |    |
| YT-3590     | 2.5; 3.0; 4.0; 5.0; 6.0; 7.0; 8.0; 9.0; 10.0 | 50 |

|             |   |    |
|-------------|---|----|
| <b>YATO</b> | size / rozmiar  |    |
| YT-3591     | 2.0; 2.5; 3.2; 4.0; 4.8; 5.5; 6.4; 8.0; 9.5; 11.1; 12.7; 14.0; 15.8; 19.0; 22.0 | 10 |





- GB PVC pipe cutter
- D PVC Rohrabsschneider
- PL Obcinak do rur PCV
- RUS Труборез для ПВХ труб
- CZ Řezač PVC trubek
- H Csővágó olló PVC csövekhez
- RO Clește pt. tăiat țevi din PVC
- F Coupeur aux tubes
- I Taglia tubi PVC
- E Cortatubos PVC
- CN PVC 管子割刀



|                        |              |                                       |        |
|------------------------|--------------|---------------------------------------|--------|
| $\varnothing$ max (mm) | PVC PP PU PE | 8Cr13 STAINLESS STEEL STAL NIERDZEWNA | HRC 54 |
|------------------------|--------------|---------------------------------------|--------|





|   |                         |   |
|---|-------------------------|---|
| <b>YATO</b>  | max. $\varnothing$ (mm) |  |
| YT-2230   | 35                      | 6/48  |

- GB PVC pipe cutter
- D PVC Rohrabsschneider
- PL Obcinak do rur PCV
- RUS Труборез для ПВХ труб
- CZ Řezač PVC trubek
- H Csővágó olló PVC csövekhez
- RO Clește pt. tăiat țevi din PVC
- F Coupeur aux tubes
- I Taglia tubi PVC
- E Cortatubos PVC
- CN PVC 管子割刀



|                        |              |                                       |        |                          |                                  |
|------------------------|--------------|---------------------------------------|--------|--------------------------|----------------------------------|
| $\varnothing$ max (mm) | PVC PP PU PE | 8Cr13 STAINLESS STEEL STAL NIERDZEWNA | HRC 54 | RATCHET SYSTEM ZAPADKOWY | QUICK RELEASE SZYBKIE ZWALNIANIE |
|------------------------|--------------|---------------------------------------|--------|--------------------------|----------------------------------|





|   |                         |   |
|---|-------------------------|---|
| <b>YATO</b>  | max. $\varnothing$ (mm) |  |
| YT-2231   | 42                      | 6/48  |

- GB PVC pipe cutter
- D PVC Rohrabsschneider
- PL Obcinak do rur PCV
- RUS Труборез для ПВХ труб
- CZ Řezač PVC trubek
- H Csővágó olló PVC csövekhez
- RO Clește pt. tăiat țevi din PVC
- F Coupeur aux tubes
- I Taglia tubi PVC
- E Cortatubos PVC
- CN PVC 管子割刀



|                        |              |                                       |           |                          |                                  |
|------------------------|--------------|---------------------------------------|-----------|--------------------------|----------------------------------|
| $\varnothing$ max (mm) | PVC PP PU PE | 8Cr13 STAINLESS STEEL STAL NIERDZEWNA | HRC 56-58 | RATCHET SYSTEM ZAPADKOWY | QUICK RELEASE SZYBKIE ZWALNIANIE |
|------------------------|--------------|---------------------------------------|-----------|--------------------------|----------------------------------|





|   |                         |   |
|---|-------------------------|---|
| <b>YATO</b>  | max. $\varnothing$ (mm) |  |
| YT-22312  | 63                      | 6/24  |

- GB PVC pipe cutter
- D PVC Rohrabsschneider
- PL Obcinak do rur PCV
- RUS Труборез для ПВХ труб
- CZ Řezač PVC trubek
- H Csővágó olló PVC csövekhez
- RO Clește pt. tăiat țevi din PVC
- F Coupeur aux tubes
- I Taglia tubi PVC
- E Cortatubos PVC
- CN PVC 管子割刀





|                        |              |                                       |        |    |                          |                                  |
|------------------------|--------------|---------------------------------------|--------|----|--------------------------|----------------------------------|
| $\varnothing$ max (mm) | PVC PP PU PE | 8Cr13 STAINLESS STEEL STAL NIERDZEWNA | HRC 54 | AI | RATCHET SYSTEM ZAPADKOWY | QUICK RELEASE SZYBKIE ZWALNIANIE |
|------------------------|--------------|---------------------------------------|--------|----|--------------------------|----------------------------------|

$\varnothing$  max (mm)  
**51**

|   |                         |   |
|---|-------------------------|---|
| <b>YATO</b>  | max. $\varnothing$ (mm) |  |
| YT-2228   | 51                      | 6/24  |



$\varnothing$  max (mm)  
**64**

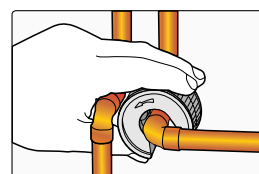

|   |                         |   |
|---|-------------------------|---|
| <b>YATO</b>  | max. $\varnothing$ (mm) |  |
| YT-2229   | 64                      | 6/24  |

- GB Pipe cutter
- D Rohrabsschneider
- PL Obcinak do rur
- RUS Труборез для труб
- CZ Řezač trubek
- H Csővágó olló csövekhez
- RO Clește pt. tăiat țevi
- F Coupeurs aux tubes
- I Rullo di taglio per tubi
- E Cortatubos
- CN 管子割刀



|                |                              |
|----------------|------------------------------|
| PLASTIC Al, Cu | BEARING STEEL STAL ŁOŻYSKOWA |
|----------------|------------------------------|



| YATO  | $\varnothing$  | external diameter / średnica zewnętrzna (mm) |  |
|--|----------------|--|---|
| YT-22353   | 19/32" (15 mm) | 48   | 10/100  |
| YT-22354   | 23/32" (18 mm) | 59   | 10/50   |
| YT-22355   | 7/8" (22 mm)   | 56   | 10/50   |

GB Pipe cutter      CZ Řezač trubek      F Coupeur aux tubes  
 D Rohrschneider      H Csővágó olló      I Taglia tubi PVC  
 PL Obcinak do rur      csővekhez      E Cortatubos  
 RUS Труборез для труб      RO Clește pt. țăiat țevi      CN 管子割刀

COLOR BOX



Ø 1/10"-7/8"  
 Ø 3-22 mm



|             |                      |     |
|-------------|----------------------|-----|
| <b>YATO</b> | Ø                    |     |
| YT-22318    | 1/10"-7/8" (3-22 mm) | 100 |



Ø 1/10"-5/4"  
 Ø 3-32 mm

QUICK-ADJUSTMENT  
 SZYBKONASTAWNY

WITH DEBURRER  
 Z GRATOWNIKIEM



|             |                      |    |
|-------------|----------------------|----|
| <b>YATO</b> | Ø                    |    |
| YT-22338    | 1/10"-5/4" (3-32 mm) | 50 |



Ø 3/8"-1-5/8"  
 Ø 10-40 mm



|             |                        |    |
|-------------|------------------------|----|
| <b>YATO</b> | Ø                      |    |
| YT-22322    | 3/8"-1-5/8" (10-40 mm) | 20 |



Ø 1/4"-7/4"  
 Ø 6-45 mm

WITH DEBURRER  
 Z GRATOWNIKIEM



|             |                     |    |
|-------------|---------------------|----|
| <b>YATO</b> | Ø                   |    |
| YT-22333    | 1/4"-7/4" (6-45 mm) | 25 |



Ø 1/2"-5/2"  
 Ø 14-63 mm

QUICK-ADJUSTMENT  
 SZYBKONASTAWNY



|             |                      |    |
|-------------|----------------------|----|
| <b>YATO</b> | Ø                    |    |
| YT-22334    | 1/2"-5/2" (14-63 mm) | 25 |



Ø 2"-5"  
 Ø 50-127 mm

QUICK-ADJUSTMENT  
 SZYBKONASTAWNY



|             |                   |    |
|-------------|-------------------|----|
| <b>YATO</b> | Ø                 |    |
| YT-22335    | 2"-5" (50-127 mm) | 10 |

GB Replacement cutting wheel for pipe cutters  
 D Ersatzschneidrad für Rohrschneider  
 PL Zapasowe kółko tnące do obcinaka do rur  
 RUS Запасной режущий диск для труборезов  
 CZ Náhradní řezné kolečko na trubky frézy

H Tartalék vágókerék cső vágó  
 RO Roata de schimb pt. taiere țevi  
 F Molette pour coupe  
 I Taglio ruote tubo taglierina  
 E Rueda de corte de repuesto para cortatubos  
 CN 管子割刀刀片

2 PCS

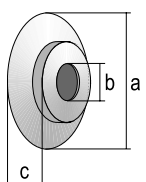

DOUBLE BLISTER

| YATO     | a (mm) | b (mm) | c (mm) | for/dla: |        |
|----------|--------|--------|--------|----------|--------|
| YT-22313 | 18     | 6      | 4.8    | YT-2233  | 50/300 |
| YT-22314 | 26     | 14     | 7.5    | YT-2232  | 6/108  |
| YT-22315 | 18     | 6      | 4.8    | YT-22338 | 50/300 |
| YT-22316 | 27     | 6.3    | 5      | YT-2234  | 24/288 |

GB Replacement cutting wheel for pipe cutters  
 D Ersatzschneidrad für Rohrschneider  
 PL Zapasowe kółko tnące do obcinaka do rur  
 RUS Запасной режущий диск для труборезов  
 CZ Náhradní řezné kolečko na trubky frézy

H Tartalék vágókerék cső vágó  
 RO Roata de schimb pt. taiere țevi  
 F Molette pour coupe  
 I Taglio ruote tubo taglierina  
 E Rueda de corte de repuesto para cortatubos  
 CN 管子割刀刀片

BEARING STEEL

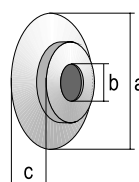

DOUBLE BLISTER

| YATO     | a (mm) | b (mm) | c (mm) | for/dla: |        |
|----------|--------|--------|--------|----------|--------|
| YT-22317 | 44     | 10.6   | 8      | YT-2235  | 12/144 |



- |                               |                                |   |
|-------------------------------|--------------------------------|---|
| <b>GB</b> Window scraper      | <b>CZ</b> Škrabák na skla      | <b>I</b> Coltellino con lama trapezoidale |
| <b>D</b> Fensterabstreicher   | <b>H</b> Kaparó üveghez        | <b>E</b> Rascador de cristales            |
| <b>PL</b> Skrobak do szyb     | <b>RO</b> Răzuitor pt. geamuri | <b>CN</b> 玻璃刮刀                            |
| <b>RUS</b> Скребок для стекла | <b>F</b> Gratte-givre          |   |

HALF  
DOUBLE  
BLISTER





 18x100 mm

SK5

 ALUMINIUM



ABS



| YATO  | L (mm) |  |
|--|--------|---|
| YT-7550  | 300    | 10/60   |



TELESCOPIC  
HANDLE  
390-600  
mm

| YATO  | L (mm)  |  |
|--|---------|---|
| YT-7551  | 390-600 | 10/60   |

- |                              |                         |
|------------------------------|-------------------------|
| <b>GB</b> Scraper            | <b>RO</b> Honuitor      |
| <b>D</b> Ziehklinge          | <b>F</b> Racléuse métal |
| <b>PL</b> Cyklina            | <b>I</b> Raschietto     |
| <b>RUS</b> Цикля             | <b>E</b> Raspador       |
| <b>CZ</b> Skrabka na parkety | <b>CN</b> 刮刀            |
| <b>H</b> Simitógyalu         |                         |



HALF  
DOUBLE  
BLISTER



TUNGSTEN  
CARBIDE  
WEGLIK  
WOLFRAMU





BLADE  
 22mm

| YATO  | L (mm) |  |
|--|--------|---|
| YT-5702  | 240    | 6/48  |





BLADE  
 50 mm

| YATO  | L (mm) |  |
|--|--------|---|
| YT-5703  | 250    | 6/48  |



BLADE  
 65 mm

| YATO  | L (mm) |  |
|--|--------|---|
| YT-5704  | 290    | 6/48  |

GB Steel file  
 D Werkstatt-Feile  
 PL Piłnik do metalu  
 RUS Напильник слесарный  
 CZ Zámeňický pilník  
 H Lakatos reszelő

RO Pila de lăcătușerie  
 F Lime à métal  
 I Lime per metallo  
 E Lima para metal  
 CN 锉

PLASTIC HANGER



|        |        |        |           |
|--------|--------|--------|-----------|
| #1     | #2     | #3     | T12 STEEL |
| 150 mm | 200 mm | 250 mm | 300 mm    |



| YATO    | # | L (mm) |       |
|---------|---|--------|-------|
| YT-6223 | 1 | 250    | 20/80 |
| YT-6180 | 2 | 150    | 20/80 |
| YT-6185 | 2 | 200    | 20/80 |
| YT-6228 | 2 | 250    | 20/80 |
| YT-6190 | 2 | 300    | 10/40 |
| YT-6233 | 3 | 250    | 20/80 |

| YATO    | # | L (mm) |       |
|---------|---|--------|-------|
| YT-6224 | 1 | 250    | 20/80 |
| YT-6181 | 2 | 150    | 20/80 |
| YT-6186 | 2 | 200    | 20/80 |
| YT-6229 | 2 | 250    | 20/80 |
| YT-6191 | 2 | 300    | 10/40 |



| YATO    | # | L (mm) |       |
|---------|---|--------|-------|
| YT-6225 | 1 | 250    | 20/80 |
| YT-6182 | 2 | 150    | 20/80 |
| YT-6187 | 2 | 200    | 20/80 |
| YT-6230 | 2 | 250    | 20/80 |
| YT-6192 | 2 | 300    | 10/40 |
| YT-6234 | 3 | 250    | 20/80 |

| YATO    | # | L (mm) |       |
|---------|---|--------|-------|
| YT-6226 | 1 | 250    | 20/80 |
| YT-6183 | 2 | 150    | 20/80 |
| YT-6188 | 2 | 200    | 20/80 |
| YT-6231 | 2 | 250    | 20/80 |
| YT-6193 | 2 | 300    | 10/40 |
| YT-6235 | 3 | 250    | 20/80 |



| YATO    | # | L (mm) |       |
|---------|---|--------|-------|
| YT-6227 | 1 | 250    | 20/80 |
| YT-6184 | 2 | 150    | 20/80 |
| YT-6189 | 2 | 200    | 20/80 |
| YT-6232 | 2 | 250    | 20/80 |
| YT-6194 | 2 | 300    | 10/40 |
| YT-6236 | 3 | 250    | 20/80 |

GB Steel file set  
 D Werkstatt-Feilen  
 PL Piłniki do metalu  
 RUS Набор напильников слесарных  
 CZ Zámeňické pilníky  
 H Lakatos reszelő

RO Pile de lăcătușerie  
 F Set de limes à métal  
 I Lime per metallo  
 E Juego de limas para metal  
 CN 钢锉组套

SLIDING CARD



|        |    |           |
|--------|----|-----------|
| #1     | #2 | #3        |
| 250 mm |    | T12 STEEL |

3 PCS

#2

#2

#2



5 PCS

#1 #2

#1

#1

#1

#1



5 PCS

#3

#3

#3

#3

#3

#3



|         |       |  |
|---------|-------|--|
| YATO    |       |  |
| YT-6237 | 10/20 |  |

|         |      |  |
|---------|------|--|
| YATO    |      |  |
| YT-6238 | 5/10 |  |

|         |      |  |
|---------|------|--|
| YATO    |      |  |
| YT-6239 | 5/10 |  |



GB Needle file set  
D Nadelfeileinsatz  
PL Zestaw pilników igłaków  
RUS Набор напильников надфили  
CZ Sada jehlových pilníků  
H Túreszelő készlet

RO Set pile conice  
F Set de limes  
I Set di lime e lime ad ago  
E Juego de limas de aguja  
CN 什锦锉组套

POUCH

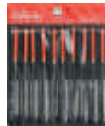

GCR15  
BEARING  
STEEL

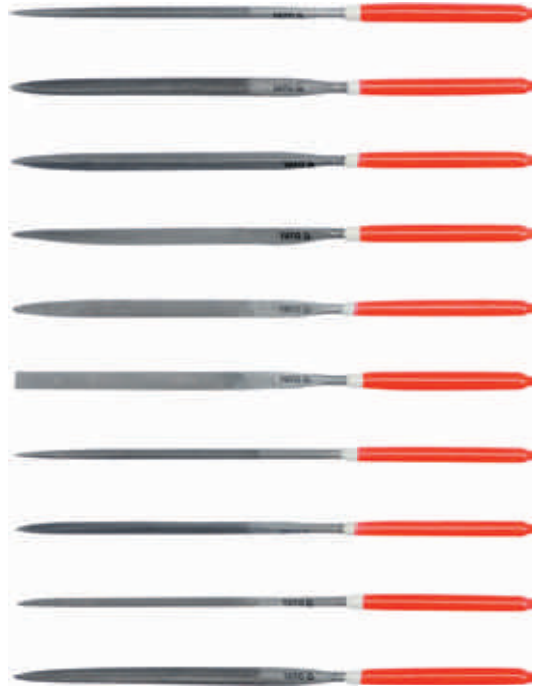

6  
PCS

10  
PCS

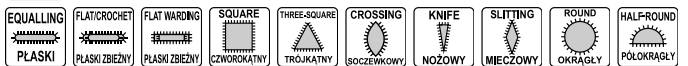
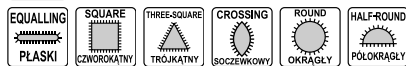

| YATO    | working length /<br>długość robocza (mm) | mm    |        |
|---------|--|-------|--------|
| YT-6160 | 65                                       | 3x140 | 50/200 |
| YT-6161 | 75                                       | 4x160 | 25/100 |
| YT-6162 | 85                                       | 5x180 | 25/100 |

| YATO    | working length /<br>długość robocza (mm) | mm    |        |
|---------|--|-------|--------|
| YT-6163 | 65                                       | 3x140 | 25/100 |
| YT-6164 | 75                                       | 4x160 | 25/100 |
| YT-6165 | 85                                       | 5x180 | 25/50  |

GB Diamond needle file  
D Diamant-Nadelfeile  
PL Pilnik iglak diamentowy  
RUS Надфиль алмазный

CZ Diamantový jehlový pilník  
H Gyémánt túreszelő  
RO Pila diamentata  
F Lime diamant

I Lime ad ago diamentate  
E Lima de aguja adiamantada  
CN 金刚石平头扁锉

SLIDING  
CARD



GRIT  
ZIARNISTOŚĆ  
150



| YATO    | grit /<br>ziarnistość | coating length /<br>długość nasypu (mm) | mm    |          |
|---------|-----------------------|---|-------|----------|
| YT-6140 | 150                   | 50                                      | 3x140 | 120/1200 |
| YT-6147 | 150                   | 50                                      | 4x160 | 80/800   |
| YT-6152 | 150                   | 70                                      | 5x180 | 45/450   |

| YATO    | grit /<br>ziarnistość | coating length /<br>długość nasypu (mm) | mm    |          |
|---------|-----------------------|---|-------|----------|
| YT-6141 | 150                   | 50                                      | 3x140 | 120/1200 |
| YT-6148 | 150                   | 50                                      | 4x160 | 80/800   |
| YT-6153 | 150                   | 70                                      | 5x180 | 45/450   |

| YATO    | grit /<br>ziarnistość | coating length /<br>długość nasypu (mm) | mm    |          |
|---------|-----------------------|---|-------|----------|
| YT-6142 | 150                   | 50                                      | 3x140 | 120/1200 |
| YT-6149 | 150                   | 50                                      | 4x160 | 80/800   |
| YT-6154 | 150                   | 70                                      | 5x180 | 45/450   |

GB Diamond needle file set  
D Diamant-Nadelfeileinsatz  
PL Zestaw pilników diamentowych igłaków  
RUS Набор надфилей алмазных  
CZ Sada diamentových jehlových pilníků  
H Gyémánt túreszelő készlet

RO Set pile diamentate  
F Set de limes diamant  
I Set lime ad ago diamentate  
E Juego de limas de aguja adiamantadas  
CN 金刚石整形锉组套

POUCH

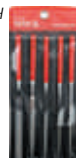

GRIT  
ZIARNISTOŚĆ  
150

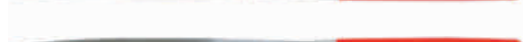

3  
PCS

5  
PCS



| YATO    | grit /<br>ziarnistość | coating length /<br>długość nasypu (mm) | mm    |        |
|---------|-----------------------|---|-------|--------|
| YT-6143 | 150                   | 50                                      | 3x140 | 40/400 |
| YT-6150 | 150                   | 50                                      | 4x160 | 30/300 |
| YT-6155 | 150                   | 70                                      | 5x180 | 15/150 |

| YATO    | grit /<br>ziarnistość | coating length /<br>długość nasypu (mm) | mm    |        |
|---------|-----------------------|---|-------|--------|
| YT-6156 | 150                   | 70                                      | 5x180 | 10/100 |

- GB Diamond needle file set
- D Diamant-Nadelfeilsatz
- PL Zestaw pilników diamentowych iglaków
- RUS Набор надфилей алмазных
- CZ Sada diamentových jehlových pilníků
- H Gyémánt tűreszelő készlet
- RO Set pile diamantate
- F Set de limes diamant
- I Set lime ad ago diamantate
- E Juego de limas de aguja adiamantadas
- CN 金刚石整形锉组套



**10**  
PCS

**GRIT**  
ZIARNISTOŚĆ  
**150**

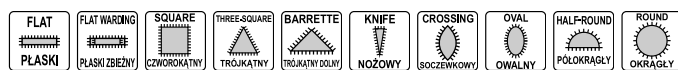
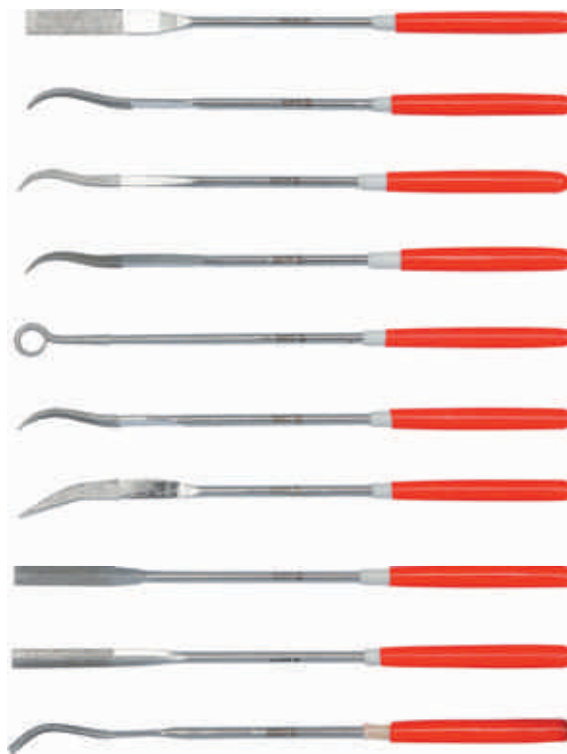

| YATO    | grit /<br>ziarnistość | coating length /<br>długość nasypu (mm) | mm    |        |
|---------|-----------------------|---|-------|--------|
| YT-6144 | 150                   | 50                                      | 3x140 | 12/120 |

| YATO    | grit /<br>ziarnistość | coating length /<br>długość nasypu (mm) | mm    |        |
|---------|-----------------------|---|-------|--------|
| YT-6145 | 150                   | 25                                      | 3x140 | 12/120 |

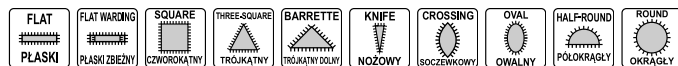

| YATO    | grit /<br>ziarnistość | coating length /<br>długość nasypu (mm) | mm    |        |
|---------|-----------------------|---|-------|--------|
| YT-6146 | 150                   | 30                                      | 3x140 | 12/120 |

| YATO    | grit /<br>ziarnistość | coating length /<br>długość nasypu (mm) | mm    |      |
|---------|-----------------------|---|-------|------|
| YT-6151 | 150                   | 50                                      | 4x160 | 9/90 |



- |                              |                                |
|------------------------------|--------------------------------|
| <b>GB</b> Wood rasp          | <b>RO</b> Raspe                |
| <b>D</b> Holzraspel          | <b>F</b> Lime à bois           |
| <b>PL</b> Tarnik do drewna   | <b>I</b> Lime per legno        |
| <b>RUS</b> Рапили для дерева | <b>E</b> Escarpelo para madera |
| <b>CZ</b> Rašple do dřeva    | <b>CN</b> 木工銼                  |
| <b>H</b> Fareszelő           |                                |



PLASTIC  
HANGER



250  
mm





# 45

| YATO  | #  |  |
|--|----|---|
| YT-6219  | 45 | 12/72   |





# 45

| YATO  | #  |  |
|--|----|---|
| YT-6220  | 45 | 12/72   |



# 45

| YATO  | #  |  |
|--|----|---|
| YT-6221  | 45 | 12/72   |

- |                                |  |
|--------------------------------|--|
| <b>GB</b> Wood rasp set        | <b>RO</b> Set raspe                      |
| <b>D</b> Holzraspelsatz        | <b>F</b> Set de limes à bois             |
| <b>PL</b> Tarniki do drewna    | <b>I</b> Lime per legno                  |
| <b>RUS</b> Рапили для дерева   | <b>E</b> Juego de escarpelos para madera |
| <b>CZ</b> Sada rašplí do dřeva | <b>CN</b> 木工銼組套                          |
| <b>H</b> Fareszelő             |  |

SLIDING  
CARD



3  
PCS



# 45

250  
mm

# 45

# 45



| YATO  | #  |  |
|--|----|---|
| YT-6222  | 45 | 5/20  |

GB Sand paper PL Papier ścierny CZ Smirkový papír RO Hârtie abrazivă I Carta vetrata CN 砂纸  
 D Schleifpapier RUS Наждачная бумага H Csiszolópapír F Papier abrasif E Papel de lija

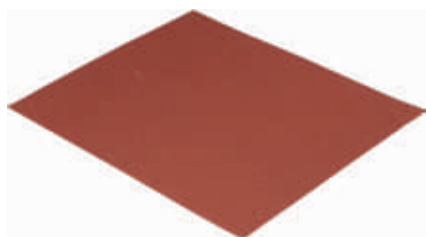

POLYBAG



- application: paint, lacquer, filler, wood
- abrasive: aluminium oxide
- bond: synthetic resin
- backing: C
- coating: semi-open
- zastosowanie: farby, lakiery, szpachle, drewno
- ścierniwo: tlenek glinu
- spoiwo: żywica syntetyczna
- podkład: C
- nasyp półotwarty



- application: paint, lacquer, filler, wood
- abrasive: aluminium oxide
- bond: synthetic resin
- backing: D
- coating: semi-open
- zastosowanie: farby, lakiery, szpachle, drewno
- ścierniwo: tlenek glinu
- spoiwo: żywica syntetyczna
- podkład: D
- nasyp półotwarty

| YATO    | grit / ziarnistość | size / rozmiar (mm) | PCS packing |     |
|---------|--------------------|---------------------|-------------|-----|
| YT-8350 | 40                 | 230x280             | 50          | 500 |
| YT-8351 | 60                 | 230x280             | 50          | 500 |
| YT-8352 | 80                 | 230x280             | 50          | 500 |
| YT-8353 | 100                | 230x280             | 50          | 500 |
| YT-8354 | 120                | 230x280             | 50          | 500 |
| YT-8355 | 150                | 230x280             | 50          | 500 |
| YT-8356 | 180                | 230x280             | 50          | 500 |
| YT-8357 | 220                | 230x280             | 50          | 500 |
| YT-8358 | 240                | 230x280             | 50          | 500 |

| YATO    | grit / ziarnistość | size / rozmiar |       |
|---------|--------------------|----------------|-------|
| YT-8449 | 40                 | 93 mm x 5 m    | 12/48 |
| YT-8450 | 60                 | 93 mm x 5 m    | 12/48 |
| YT-8451 | 80                 | 93 mm x 5 m    | 12/48 |
| YT-8452 | 100                | 93 mm x 5 m    | 12/48 |
| YT-8453 | 120                | 93 mm x 5 m    | 12/48 |
| YT-8454 | 150                | 93 mm x 5 m    | 12/48 |
| YT-8455 | 180                | 93 mm x 5 m    | 12/48 |
| YT-8456 | 240                | 93 mm x 5 m    | 12/48 |
| YT-8457 | 320                | 93 mm x 5 m    | 12/48 |



POLYBAG WITH HEADER



- application: paint, lacquer, filler, wood
- abrasive: aluminium oxide
- bond: synthetic resin
- backing: D
- coating: semi-open
- zastosowanie: farby, lakiery, szpachle, drewno
- ścierniwo: tlenek glinu
- spoiwo: żywica syntetyczna
- podkład: D
- nasyp półotwarty



- application: paint, lacquer, filler, wood
- abrasive: aluminium oxide
- bond: synthetic resin
- backing: D
- coating: semi-open
- zastosowanie: farby, lakiery, szpachle, drewno
- ścierniwo: tlenek glinu
- spoiwo: żywica syntetyczna
- podkład: D
- nasyp półotwarty

| YATO    | grit / ziarnistość | size / rozmiar (mm) | PCS packing |        |
|---------|--------------------|---------------------|-------------|--------|
| YT-8370 | 40                 | 115x280             | 5           | 24/240 |
| YT-8371 | 60                 | 115x280             | 5           | 24/240 |
| YT-8372 | 80                 | 115x280             | 5           | 24/240 |
| YT-8373 | 100                | 115x280             | 5           | 24/240 |
| YT-8374 | 120                | 115x280             | 5           | 24/240 |
| YT-8375 | 150                | 115x280             | 5           | 24/240 |
| YT-8376 | 180                | 115x280             | 5           | 24/240 |
| YT-8377 | 240                | 115x280             | 5           | 24/240 |
| YT-8378 | 320                | 115x280             | 5           | 24/240 |

| YATO    | grit / ziarnistość | size / rozmiar |       |
|---------|--------------------|----------------|-------|
| YT-8440 | 40                 | 115 mm x 5 m   | 12/48 |
| YT-8441 | 60                 | 115 mm x 5 m   | 12/48 |
| YT-8442 | 80                 | 115 mm x 5 m   | 12/48 |
| YT-8443 | 100                | 115 mm x 5 m   | 12/48 |
| YT-8444 | 120                | 115 mm x 5 m   | 12/48 |
| YT-8445 | 150                | 115 mm x 5 m   | 12/48 |
| YT-8446 | 180                | 115 mm x 5 m   | 12/48 |
| YT-8447 | 240                | 115 mm x 5 m   | 12/48 |
| YT-8448 | 320                | 115 mm x 5 m   | 12/48 |



POLYBAG



- application: paint, lacquer, filler, wood
- abrasive: aluminium oxide
- bond: synthetic resin
- backing: D
- coating: semi-open
- zastosowanie: farby, lakiery, szpachle, drewno
- ścierniwo: tlenek glinu
- spoiwo: żywica syntetyczna
- podkład: D
- nasyp półotwarty



- application: paint, lacquer, filler, wood
- abrasive: aluminium oxide
- bond: synthetic resin
- backing: D
- coating: semi-open
- zastosowanie: farby, lakiery, szpachle, drewno
- ścierniwo: tlenek glinu
- spoiwo: żywica syntetyczna
- podkład: D
- nasyp półotwarty

| YATO    | grit / ziarnistość | size / rozmiar (mm) | PCS packing |     |
|---------|--------------------|---------------------|-------------|-----|
| YT-8360 | 40                 | 230x280             | 50          | 500 |
| YT-8361 | 60                 | 230x280             | 50          | 500 |
| YT-8362 | 80                 | 230x280             | 50          | 500 |
| YT-8363 | 100                | 230x280             | 50          | 500 |
| YT-8364 | 120                | 230x280             | 50          | 500 |
| YT-8365 | 150                | 230x280             | 50          | 500 |
| YT-8366 | 180                | 230x280             | 50          | 500 |
| YT-8367 | 240                | 230x280             | 50          | 500 |
| YT-8368 | 320                | 230x280             | 50          | 500 |

| YATO    | grit / ziarnistość | size / rozmiar |   |
|---------|--------------------|----------------|---|
| YT-8458 | 40                 | 115 mm x 50 m  | 2 |
| YT-8459 | 60                 | 115 mm x 50 m  | 2 |
| YT-8460 | 80                 | 115 mm x 50 m  | 2 |
| YT-8461 | 100                | 115 mm x 50 m  | 2 |
| YT-8462 | 120                | 115 mm x 50 m  | 2 |
| YT-8463 | 150                | 115 mm x 50 m  | 2 |
| YT-8464 | 180                | 115 mm x 50 m  | 2 |
| YT-8465 | 240                | 115 mm x 50 m  | 2 |
| YT-8466 | 320                | 115 mm x 50 m  | 2 |



GB Sand paper    PL Papier ścierny    CZ Smrkový papír    RO Hârtie abrazivă    I Carta vetrata    CN 砂纸  
D Schleifpapier    RUS Наждачная бумага    H Csiszolópapír    F Papier abrasif    E Papel de lija







- application: paint, lacquer, filler, wood
- abrasive: aluminium oxide
- bond: synthetic resin
- backing: F
- coating: closed

- zastosowanie: farby, lakiery, szpachle, drewno
- ścierniwo: tlenek glinu
- spoiwo: żywica syntetyczna
- podkład: F
- nasyp pełny

- application: paint, lacquer, filler, wood
- abrasive: aluminium oxide
- bond: synthetic resin
- backing: F
- coating: closed

- zastosowanie: farby, lakiery, szpachle, drewno
- ścierniwo: tlenek glinu
- spoiwo: żywica syntetyczna
- podkład: F
- nasyp pełny

| YATO  | grit / ziarnistość | size / rozmiar |  |
|--|--------------------|----------------|---|
| YT-8480  | 80                 | 150 mm x 50 m  | 2   |
| YT-8481  | 100                | 150 mm x 50 m  | 2   |
| YT-8482  | 120                | 150 mm x 50 m  | 2   |

| YATO  | grit / ziarnistość | size / rozmiar |  |
|--|--------------------|----------------|---|
| YT-8483  | 40                 | 200 mm x 50 m  | 2   |
| YT-8484  | 60                 | 200 mm x 50 m  | 2   |
| YT-8485  | 80                 | 200 mm x 50 m  | 2   |
| YT-8486  | 120                | 200 mm x 50 m  | 2   |

GB Abrasive cloth sheet    RUS Шлифовальное полотно    RO Coli panza abraziva    E Hojas de pano abrasivo  
D Schleifgewebe blatt    CZ Brusné plátno    F Tissu abrasif    CN 砂布  
PL Plótno ściernie arkusz    H Csiszolóvászon lap    I Carta vetrata



WATERPROOF  
WODOODPORNY

POLYBAG

WATERPROOF  
WODOODPORNY

POLYBAG



- application: paint, lacquer, filler
- abrasive: silicon carbide
- bond: synthetic resin
- backing: C
- coating: closed



- zastosowanie: farby, lakiery, szpachle
- ścierniwo: węgiel krzemu
- spoiwo: żywica syntetyczna
- podkład: C
- nasyp pełny



- application: paint, lacquer, filler
- abrasive: silicon carbide
- bond: synthetic resin
- backing: A
- coating: closed

- zastosowanie: farby, lakiery, szpachle
- ścierniwo: węgiel krzemu
- spoiwo: żywica syntetyczna
- podkład: A
- nasyp pełny

| YATO  | grit / ziarnistość | size / rozmiar (mm) | PCS<br>packing: |  |
|--|--------------------|---------------------|-----------------|---|
| YT-8400  | 60                 | 230x280             | 50              | 500   |
| YT-8401  | 80                 | 230x280             | 50              | 500   |
| YT-8402  | 100                | 230x280             | 50              | 500   |
| YT-8403  | 120                | 230x280             | 50              | 500   |
| YT-8404  | 150                | 230x280             | 50              | 500   |

| YATO  | grit / ziarnistość | size / rozmiar (mm) | PCS<br>packing: |  |
|--|--------------------|---------------------|-----------------|---|
| YT-8405  | 180                | 230x280             | 50              | 500   |
| YT-8406  | 220                | 230x280             | 50              | 500   |
| YT-8407  | 240                | 230x280             | 50              | 500   |
| YT-8408  | 280                | 230x280             | 50              | 500   |
| YT-8409  | 320                | 230x280             | 50              | 500   |
| YT-8410  | 360                | 230x280             | 50              | 500   |
| YT-8411  | 400                | 230x280             | 50              | 500   |
| YT-8412  | 500                | 230x280             | 50              | 500   |
| YT-8413  | 600                | 230x280             | 50              | 500   |
| YT-8414  | 800                | 230x280             | 50              | 500   |
| YT-8415  | 1000               | 230x280             | 50              | 500   |
| YT-8416  | 1200               | 230x280             | 50              | 500   |
| YT-8417  | 1500               | 230x280             | 50              | 500   |
| YT-8418  | 2000               | 230x280             | 50              | 500   |





- application: metal, wood
- abrasive: aluminium oxide
- bond: semi-resin
- backing: J
- coating: close

- zastosowanie: metal, drewno
- ścierniwo: tlenek glinu
- spoiwo: żywica
- podkład: J
- nasyp pełny

POLYBAG



| YATO  | grit / ziarnistość | size / rozmiar (mm) | PCS<br>packing: |  |
|--|--------------------|---------------------|-----------------|---|
| YT-83160   | 36                 | 230x280             | 50              | 250   |
| YT-83161   | 40                 | 230x280             | 50              | 250   |
| YT-83162   | 60                 | 230x280             | 50              | 250   |
| YT-83163   | 80                 | 230x280             | 50              | 250   |
| YT-83164   | 100                | 230x280             | 50              | 250   |
| YT-83165   | 120                | 230x280             | 50              | 500   |
| YT-83166   | 150                | 230x280             | 50              | 500   |
| YT-83167   | 180                | 230x280             | 50              | 500   |
| YT-83168   | 220                | 230x280             | 50              | 500   |
| YT-83169   | 240                | 230x280             | 50              | 500   |

GB Abrasive cloth roll      RUS Рулон-шлифовальное полотно      RO Rola panza abraziva      E Rollo de pano abrasivo  
 D Schleifgewebe rolle      CZ Brusné plátno role      F Tissu abrasif rouleau      CN 砂布  
 PL Piótno ścierna rolka      H Csiszolóvászon tekercs      I Carta vetrata rotolo



- application: metal, wood      • zastosowanie: metal, drewno      • application: metal, wood      • zastosowanie: metal, drewno      • application: metal, wood      • zastosowanie: metal, drewno
- abrasive: aluminium oxide      • ścierniwo: tlenek glinu      • abrasive: aluminium oxide      • ścierniwo: tlenek glinu      • abrasive: aluminium oxide      • ścierniwo: tlenek glinu
- bond: semi-resin      • spoiwo: żywica      • bond: semi-resin      • spoiwo: żywica      • bond: semi-resin      • spoiwo: żywica
- backing: J      • podkład: J      • backing: J      • podkład: J      • backing: J      • podkład: J
- coating: close      • nasyp pełny      • coating: close      • nasyp pełny      • coating: close      • nasyp pełny

| YATO     | grit / ziarnistość | size / rozmiar | PCS |
|----------|--------------------|----------------|-----|
| YT-83180 | 36                 | 150 mm x 30 m  | 2   |
| YT-83181 | 40                 | 150 mm x 30 m  | 2   |

| YATO     | grit / ziarnistość | size / rozmiar | PCS |
|----------|--------------------|----------------|-----|
| YT-83182 | 50                 | 150 mm x 50 m  | 2   |
| YT-83183 | 60                 | 150 mm x 50 m  | 2   |
| YT-83184 | 80                 | 150 mm x 50 m  | 2   |
| YT-83185 | 100                | 150 mm x 50 m  | 2   |
| YT-83186 | 120                | 150 mm x 50 m  | 2   |
| YT-83187 | 150                | 150 mm x 50 m  | 2   |
| YT-83188 | 180                | 150 mm x 50 m  | 2   |
| YT-83189 | 220                | 150 mm x 50 m  | 2   |
| YT-83190 | 240                | 150 mm x 50 m  | 2   |

| YATO     | grit / ziarnistość | size / rozmiar | PCS |
|----------|--------------------|----------------|-----|
| YT-83200 | 24                 | 200mm x 30 m   | 2   |
| YT-83201 | 36                 | 200mm x 30 m   | 2   |
| YT-83202 | 40                 | 200mm x 30 m   | 2   |
| YT-83203 | 50                 | 200mm x 30 m   | 2   |
| YT-83204 | 60                 | 200mm x 30 m   | 2   |
| YT-83205 | 80                 | 200mm x 30 m   | 2   |
| YT-83206 | 100                | 200mm x 30 m   | 2   |
| YT-83207 | 120                | 200mm x 30 m   | 2   |
| YT-83208 | 150                | 200mm x 30 m   | 2   |
| YT-83209 | 180                | 200mm x 30 m   | 2   |
| YT-83210 | 220                | 200mm x 30 m   | 2   |
| YT-83211 | 240                | 200mm x 30 m   | 2   |

10

GB Endless sanding belt      RUS Шлифовальные ленты      RO Bandă de pânză      E Pano abrasivo cinturón  
 D Schleifband      CZ Brusný pás      F Bande abrasive sans fin      CN 砂帶  
 PL Taśma ścierna bezkońcowa      H Csiszoló szalag      I Nastro abrasivo senza fine

TIED ON CARD



- application: metal, wood      • zastosowanie: metal, drewno      • application: metal, wood      • zastosowanie: metal, drewno
- abrasive: aluminium oxide      • ścierniwo: tlenek glinu      • abrasive: aluminium oxide      • ścierniwo: tlenek glinu
- bond: synthetic resin      • spoiwo: żywica syntetyczna      • bond: synthetic resin      • spoiwo: żywica syntetyczna
- coating: close      • nasyp pełny      • coating: close      • nasyp pełny

| YATO     | grit / ziarnistość | size / rozmiar (mm) | PCS packing |
|----------|--------------------|---------------------|-------------|
| YT-09743 | 60                 | 10x330              | 10 100      |
| YT-09744 | 80                 | 10x330              | 10 100      |
| YT-09745 | 100                | 10x330              | 10 100      |
| YT-09746 | 120                | 10x330              | 10 100      |

| YATO     | grit / ziarnistość | size / rozmiar (mm) | PCS packing |
|----------|--------------------|---------------------|-------------|
| YT-09747 | 60                 | 20x520              | 10 50       |
| YT-09748 | 80                 | 20x520              | 10 50       |
| YT-09749 | 100                | 20x520              | 10 50       |
| YT-09750 | 120                | 20x520              | 10 50       |

GB No end abrasive band      RUS Шлифлента бесконечная      RO Curea abraziva      E Banda abrasiva sin fin  
 D Schleifband      CZ Brusný pás      F Bande abrasive sans fin      CN 砂帶  
 PL Pas ścierny bezkońcowa      H Csiszoló szalag      I Nastro abrasivo senza fine



- application: metal, wood      • zastosowanie: metal, drewno      • application: metal, wood      • zastosowanie: metal, drewno      • application: metal, wood      • zastosowanie: metal, drewno
- abrasive: aluminium oxide      • ścierniwo: tlenek glinu      • abrasive: aluminium oxide      • ścierniwo: tlenek glinu      • abrasive: aluminium oxide      • ścierniwo: tlenek glinu
- bond: synthetic resin      • spoiwo: żywica syntetyczna      • bond: synthetic resin      • spoiwo: żywica syntetyczna      • bond: synthetic resin      • spoiwo: żywica syntetyczna
- coating: close      • nasyp pełny      • coating: close      • nasyp pełny      • coating: close      • nasyp pełny

| YATO     | grit / ziarnistość | size / rozmiar (mm) | PCS packing |
|----------|--------------------|---------------------|-------------|
| YT-83220 | 36                 | 75x457              | 5 20/60     |
| YT-83221 | 40                 | 75x457              | 5 20/60     |
| YT-83222 | 60                 | 75x457              | 5 20/60     |
| YT-83223 | 80                 | 75x457              | 5 20/60     |
| YT-83224 | 100                | 75x457              | 5 20/60     |
| YT-83225 | 120                | 75x457              | 5 20/60     |
| YT-83226 | 150                | 75x457              | 5 20/60     |

| YATO     | grit / ziarnistość | size / rozmiar (mm) | PCS packing |
|----------|--------------------|---------------------|-------------|
| YT-83227 | 36                 | 75x533              | 5 20/60     |
| YT-83228 | 40                 | 75x533              | 5 20/60     |
| YT-83229 | 60                 | 75x533              | 5 20/60     |
| YT-83230 | 80                 | 75x533              | 5 20/60     |
| YT-83231 | 100                | 75x533              | 5 20/60     |
| YT-83232 | 120                | 75x533              | 5 20/60     |
| YT-83233 | 150                | 75x533              | 5 20/60     |

| YATO     | grit / ziarnistość | size / rozmiar (mm) | PCS packing |
|----------|--------------------|---------------------|-------------|
| YT-83234 | 36                 | 100x610             | 5 10/30     |
| YT-83235 | 40                 | 100x610             | 5 10/30     |
| YT-83236 | 60                 | 100x610             | 5 10/30     |
| YT-83237 | 80                 | 100x610             | 5 20/60     |
| YT-83238 | 100                | 100x610             | 5 20/60     |
| YT-83239 | 120                | 100x610             | 5 20/60     |
| YT-83240 | 150                | 100x610             | 5 20/60     |



GB Flap disc – regular shape  
D Fächerschleifscheibe - Gerade  
PL Ściernica listkowa talerzowa płaska  
RUS Круг лепестковый тарельчатый  
CZ Lamelový brusný kotouč  
H Lamellás csiszoló normál

RO Disc lamelar frontal  
F Disque à lamelles abrasives plat  
I Disco abrasivo per metallo  
E Discos de paño abrasivo  
CN 百叶轮

- application: metal
- abrasive: aluminium oxide
- bond: synthetic resin
- backing: fibreglass
- zastosowanie: metal
- ścierniwo: tlenek glinu
- spoiwo: żywica syntetyczna
- podkład: włókno szklane



| YATO     | grit /<br>ziarnistość | size / rozmiar<br>(mm) |        |
|----------|-----------------------|------------------------|--------|
| YT-83251 | 36                    | 115x22.4               | 50/200 |
| YT-83252 | 40                    | 115x22.4               | 50/200 |
| YT-83253 | 60                    | 115x22.4               | 50/200 |
| YT-83254 | 80                    | 115x22.4               | 50/200 |
| YT-83255 | 100                   | 115x22.4               | 50/200 |
| YT-83256 | 120                   | 115x22.4               | 50/200 |

GB Flap disc – regular shape  
D Fächerschleifscheibe - Gerade  
PL Ściernica listkowa talerzowa płaska  
RUS Круг лепестковый тарельчатый  
CZ Lamelový brusný kotouč  
H Lamellás csiszoló normál

RO Disc lamelar frontal  
F Disque à lamelles abrasives plat  
I Disco abrasivo per metallo  
E Discos de paño abrasivo  
CN 百叶轮

- application: metal
- abrasive: aluminium oxide
- bond: synthetic resin
- backing: fibreglass
- zastosowanie: metal
- ścierniwo: tlenek glinu
- spoiwo: żywica syntetyczna
- podkład: włókno szklane



| YATO     | grit /<br>ziarnistość | size / rozmiar<br>(mm) |        |
|----------|-----------------------|------------------------|--------|
| YT-83271 | 36                    | 125x22.4               | 25/100 |
| YT-83272 | 40                    | 125x22.4               | 25/100 |
| YT-83273 | 60                    | 125x22.4               | 50/200 |
| YT-83274 | 80                    | 125x22.4               | 50/200 |
| YT-83275 | 100                   | 125x22.4               | 50/200 |
| YT-83276 | 120                   | 125x22.4               | 50/200 |

GB Flap disc – depressed shape  
D Fächerschleifscheibe - Gewölbt  
PL Ściernica listkowa talerzowa wypukła  
RUS Круг лепестковый тарельчатый  
CZ Lamelový brusný kotouč - vypuklý  
H Lamellás csiszoló döntött  
RO Disc lamelar frontal depresat

F Disque à lamelles abrasives bombé  
I Disco abrasivo a centro depresso  
E Discos de paño abrasivo centro embutido  
CN 百叶轮

- application: metal
- abrasive: aluminium oxide
- bond: synthetic resin
- backing: fibreglass
- zastosowanie: metal
- ścierniwo: tlenek glinu
- spoiwo: żywica syntetyczna
- podkład: włókno szklane



| YATO     | grit /<br>ziarnistość | size / rozmiar<br>(mm) |        |
|----------|-----------------------|------------------------|--------|
| YT-83281 | 36                    | 115x22.4               | 50/200 |
| YT-83282 | 40                    | 115x22.4               | 50/200 |
| YT-83283 | 60                    | 115x22.4               | 50/200 |
| YT-83284 | 80                    | 115x22.4               | 50/200 |
| YT-83285 | 100                   | 115x22.4               | 50/200 |
| YT-83286 | 120                   | 115x22.4               | 50/200 |

GB Flap disc – depressed shape  
D Fächerschleifscheibe - Gewölbt  
PL Ściernica listkowa talerzowa wypukła  
RUS Круг лепестковый тарельчатый  
CZ Lamelový brusný kotouč - vypuklý  
H Lamellás csiszoló döntött  
RO Disc lamelar frontal depresat

F Disque à lamelles abrasives bombé  
I Disco abrasivo a centro depresso  
E Discos de paño abrasivo centro embutido  
CN 百叶轮

- application: metal
- abrasive: aluminium oxide
- bond: synthetic resin
- backing: fibreglass
- zastosowanie: metal
- ścierniwo: tlenek glinu
- spoiwo: żywica syntetyczna
- podkład: włókno szklane



| YATO     | grit /<br>ziarnistość | size / rozmiar<br>(mm) |        |
|----------|-----------------------|------------------------|--------|
| YT-83291 | 36                    | 125x22.4               | 25/100 |
| YT-83292 | 40                    | 125x22.4               | 25/100 |
| YT-83293 | 60                    | 125x22.4               | 50/200 |
| YT-83294 | 80                    | 125x22.4               | 50/200 |
| YT-83295 | 100                   | 125x22.4               | 50/200 |
| YT-83296 | 120                   | 125x22.4               | 50/200 |

GB Flap disc – regular shape  
D Fächerschleifscheibe - Gerade  
PL Ściernica listkowa talerzowa płaska  
RUS Круг лепестковый тарельчатый  
CZ Lamelový brusný kotouč  
H Lamellás csiszoló normál

RO Disc lamelar frontal  
F Disque à lamelles abrasives plat  
I Disco abrasivo per metallo  
E Discos de paño abrasivo  
CN 百叶轮

- application: metal, inox
- abrasive: zirconia aluminium oxide
- bond: synthetic resin
- backing: fibreglass
- zastosowanie: metal, stal nierdzewna
- ścierniwo: tlenek glinu / dwutlenek cyrkonu
- spoiwo: żywica syntetyczna
- podkład: włókno szklane



| YATO     | grit /<br>ziarnistość | size / rozmiar<br>(mm) |        |
|----------|-----------------------|------------------------|--------|
| YT-83301 | 36                    | 115x22.4               | 50/200 |
| YT-83302 | 40                    | 115x22.4               | 50/200 |
| YT-83303 | 60                    | 115x22.4               | 50/200 |
| YT-83304 | 80                    | 115x22.4               | 50/200 |
| YT-83305 | 100                   | 115x22.4               | 50/200 |
| YT-83306 | 120                   | 115x22.4               | 50/200 |

GB Flap disc – regular shape  
D Fächerschleifscheibe - Gerade  
PL Ściernica listkowa talerzowa płaska  
RUS Круг лепестковый тарельчатый  
CZ Lamelový brusný kotouč  
H Lamellás csiszoló normál

RO Disc lamelar frontal  
F Disque à lamelles abrasives plat  
I Disco abrasivo per metallo  
E Discos de paño abrasivo  
CN 百叶轮

- application: metal, inox
- abrasive: zirconia aluminium oxide
- bond: synthetic resin
- backing: fibreglass
- zastosowanie: metal, stal nierdzewna
- ścierniwo: tlenek glinu / dwutlenek cyrkonu
- spoiwo: żywica syntetyczna
- podkład: włókno szklane



| YATO     | grit /<br>ziarnistość | size / rozmiar<br>(mm) |        |
|----------|-----------------------|------------------------|--------|
| YT-83311 | 36                    | 125x22.4               | 25/100 |
| YT-83312 | 40                    | 125x22.4               | 25/100 |
| YT-83313 | 60                    | 125x22.4               | 25/100 |
| YT-83314 | 80                    | 125x22.4               | 50/200 |
| YT-83315 | 100                   | 125x22.4               | 50/200 |
| YT-83316 | 120                   | 125x22.4               | 50/200 |

GB Flap disc – depressed shape  
D Fächerschleifscheibe - Gewölbt  
PL Ściernica listkowa talerzowa wypukła  
RUS Круг лепестковый тарельчатый  
CZ Lamelový brusný kotouč - vypuklý  
H Lamellás csiszoló döntött  
RO Disc lamelar frontal depresat

F Disque à lamelles abrasives bombé  
I Disco abrasivo a centro depresso  
E Discos de paño abrasivo centro embutido  
CN 百叶轮

- application: metal, inox
- abrasive: zirconia aluminium oxide
- bond: synthetic resin
- backing: fibreglass
- zastosowanie: metal, stal nierdzewna
- ścierniwo: tlenek glinu / dwutlenek cyrkonu
- spoiwo: żywica syntetyczna
- podkład: włókno szklane



| YATO     | grit /<br>ziarnistość | size / rozmiar<br>(mm) |        |
|----------|-----------------------|------------------------|--------|
| YT-83321 | 36                    | 115x22.4               | 50/200 |
| YT-83322 | 40                    | 115x22.4               | 50/200 |
| YT-83323 | 60                    | 115x22.4               | 50/200 |
| YT-83324 | 80                    | 115x22.4               | 50/200 |
| YT-83325 | 100                   | 115x22.4               | 50/200 |
| YT-83326 | 120                   | 115x22.4               | 50/200 |

GB Flap disc – depressed shape  
D Fächerschleifscheibe - Gewölbt  
PL Ściernica listkowa talerzowa wypukła  
RUS Круг лепестковый тарельчатый  
CZ Lamelový brusný kotouč - vypuklý  
H Lamellás csiszoló döntött  
RO Disc lamelar frontal depresat

F Disque à lamelles abrasives bombé  
I Disco abrasivo a centro depresso  
E Discos de paño abrasivo centro embutido  
CN 百叶轮

- application: metal, inox
- abrasive: zirconia aluminium oxide
- bond: synthetic resin
- backing: fibreglass
- zastosowanie: metal, stal nierdzewna
- ścierniwo: tlenek glinu / dwutlenek cyrkonu
- spoiwo: żywica syntetyczna
- podkład: włókno szklane



| YATO     | grit /<br>ziarnistość | size / rozmiar<br>(mm) |        |
|----------|-----------------------|------------------------|--------|
| YT-83331 | 36                    | 125x22.4               | 25/100 |
| YT-83332 | 40                    | 125x22.4               | 25/100 |
| YT-83333 | 60                    | 125x22.4               | 25/100 |
| YT-83334 | 80                    | 125x22.4               | 50/200 |
| YT-83335 | 100                   | 125x22.4               | 50/200 |
| YT-83336 | 120                   | 125x22.4               | 50/200 |



GB Flap wheel with shaft  
D Fächerschleifmop mit Schaft  
PL Ściernica listkowa trzpieniowa  
RUS Круг лепестковый со шпинделем

CZ Lamelový kotouč s hřídelí  
H Legyező csiszoló csapos  
RO Perie abraziva circulara cu tija  
F Disque à lamelles abrasives pivot

I Ruote lamellari  
E Rueda laminar en tela abrasiva  
CN 百叶轮



- application: metal
- abrasive: aluminium oxide
- bond: synthetic resin
- zastosowanie: metal
- ścierniwo: tlenek glinu
- spoiwo: żywica syntetyczna



- application: metal
- abrasive: aluminium oxide
- bond: synthetic resin
- zastosowanie: metal
- ścierniwo: tlenek glinu
- spoiwo: żywica syntetyczna

| YATO     | grit / ziarnistość | size / rozmiar (mm) |       |
|----------|--------------------|---------------------|-------|
| YT-83351 | 40                 | 40x20x6             | 10/60 |
| YT-83352 | 60                 | 40x20x6             | 10/60 |
| YT-83353 | 80                 | 40x20x6             | 10/60 |
| YT-83354 | 100                | 40x20x6             | 10/60 |
| YT-83355 | 120                | 40x20x6             | 10/60 |
| YT-83356 | 150                | 40x20x6             | 10/60 |

| YATO     | grit / ziarnistość | size / rozmiar (mm) |       |
|----------|--------------------|---------------------|-------|
| YT-83361 | 40                 | 60x30x6             | 10/60 |
| YT-83362 | 60                 | 60x30x6             | 10/60 |
| YT-83363 | 80                 | 60x30x6             | 10/60 |
| YT-83364 | 100                | 60x30x6             | 10/60 |
| YT-83365 | 120                | 60x30x6             | 10/60 |
| YT-83366 | 150                | 60x30x6             | 10/60 |



- application: metal
- abrasive: aluminium oxide
- bond: synthetic resin
- zastosowanie: metal
- ścierniwo: tlenek glinu
- spoiwo: żywica syntetyczna



- application: metal
- abrasive: aluminium oxide
- bond: synthetic resin
- zastosowanie: metal
- ścierniwo: tlenek glinu
- spoiwo: żywica syntetyczna

| YATO     | grit / ziarnistość | size / rozmiar (mm) |       |
|----------|--------------------|---------------------|-------|
| YT-83371 | 40                 | 80x30x6             | 10/60 |
| YT-83372 | 60                 | 80x30x6             | 10/60 |
| YT-83373 | 80                 | 80x30x6             | 10/60 |
| YT-83374 | 100                | 80x30x6             | 10/60 |
| YT-83375 | 120                | 80x30x6             | 10/60 |
| YT-83376 | 150                | 80x30x6             | 10/60 |

| YATO     | grit / ziarnistość | size / rozmiar (mm) |       |
|----------|--------------------|---------------------|-------|
| YT-83381 | 40                 | 80x40x6             | 10/60 |
| YT-83382 | 60                 | 80x40x6             | 10/60 |
| YT-83383 | 80                 | 80x40x6             | 10/60 |
| YT-83384 | 100                | 80x40x6             | 10/60 |
| YT-83385 | 120                | 80x40x6             | 10/60 |
| YT-83386 | 150                | 80x40x6             | 10/60 |

GB Flap wheel with shaft  
D Fächerschleifmop mit Schaft  
PL Ściernica listkowa trzpieniowa  
RUS Круг лепестковый со шпинделем  
CZ Lamelový kotouč s hřídelí  
H Legyező csiszoló csapos

RO Perie abraziva circulara cu tija  
F Disque à lamelles abrasives pivot  
I Ruote lamellari  
E Rueda laminar en tela abrasiva  
CN 百叶轮



- application: metal
- abrasive: aluminium oxide
- bond: synthetic resin

- zastosowanie: metal
- ścierniwo: tlenek glinu
- spoiwo: żywica syntetyczna

- application: metal
- abrasive: aluminium oxide
- bond: synthetic resin

- zastosowanie: metal
- ścierniwo: tlenek glinu
- spoiwo: żywica syntetyczna

- application: metal
- abrasive: aluminium oxide
- bond: synthetic resin

- zastosowanie: metal
- ścierniwo: tlenek glinu
- spoiwo: żywica syntetyczna

| YATO     | grit / ziarnistość | size / rozmiar (mm) |       |
|----------|--------------------|---------------------|-------|
| YT-83390 | 60                 | 50x30x6             | 10/60 |
| YT-83391 | 100                | 50x30x6             | 10/60 |
| YT-83392 | 150                | 50x30x6             | 10/60 |
| YT-83393 | 200                | 50x30x6             | 10/60 |

| YATO     | grit / ziarnistość | size / rozmiar (mm) |       |
|----------|--------------------|---------------------|-------|
| YT-83394 | 60                 | 60x50x6             | 10/60 |
| YT-83395 | 100                | 60x50x6             | 10/60 |
| YT-83396 | 150                | 60x50x6             | 10/60 |
| YT-83397 | 200                | 60x50x6             | 10/60 |

| YATO     | grit / ziarnistość | size / rozmiar (mm) |       |
|----------|--------------------|---------------------|-------|
| YT-83398 | 60                 | 80x50x6             | 10/60 |
| YT-83399 | 100                | 80x50x6             | 10/60 |
| YT-83400 | 150                | 80x50x6             | 10/60 |
| YT-83401 | 200                | 80x50x6             | 10/60 |



- GB Abrasive disc  
D Schleifpapier zum Gummiteller  
PL Krażek ścierny  
RUS Круг шлифовальный  
CZ Brusný kotouč  
H Csiszolótárcsa  
RO Disc abraziv  
F Disques abrasifs avec velcro  
I Disco abrasivo  
E Juego de discos abrasivos  
CN 圆形砂纸



TIED ON CARD  
**5 PCS**  
HOOK FASTENER  
RZEP

- application: metal, wood
- abrasive: aluminium oxide
- bond: synthetic resin
- backing: C
- coating: semi-open
- zastosowanie: metal, drewno
- ścierniwo: tlenek glinu
- spoiwo: żywica syntetyczna
- podkład: C
- nasyp półotwarty

| YATO     | grit / ziarnistość | Ø (mm) |        |
|----------|--------------------|--------|--------|
| YT-83420 | 36                 | 115    | 50/200 |
| YT-83421 | 40                 | 115    | 50/200 |
| YT-83422 | 60                 | 115    | 50/200 |
| YT-83423 | 80                 | 115    | 50/200 |
| YT-83424 | 100                | 115    | 50/200 |
| YT-83425 | 120                | 115    | 50/200 |
| YT-83426 | 150                | 115    | 50/200 |
| YT-83427 | 180                | 115    | 50/200 |
| YT-83428 | 220                | 115    | 50/200 |



- GB Abrasive disc  
D Schleifpapier zum Gummiteller  
PL Krażek ścierny  
RUS Круг шлифовальный  
CZ Brusný kotouč  
H Csiszolótárcsa  
RO Disc abraziv  
F Disques abrasifs avec velcro  
I Disco abrasivo  
E Juego de discos abrasivos  
CN 圆形砂纸



TIED ON CARD  
**5 PCS**  
HOOK FASTENER  
RZEP

- application: metal, wood
- abrasive: aluminium oxide
- bond: synthetic resin
- backing: C
- coating: semi-open
- zastosowanie: metal, drewno
- ścierniwo: tlenek glinu
- spoiwo: żywica syntetyczna
- podkład: C
- nasyp półotwarty

| YATO     | grit / ziarnistość | Ø (mm) |        |
|----------|--------------------|--------|--------|
| YT-83430 | 36                 | 125    | 50/200 |
| YT-83431 | 40                 | 125    | 50/200 |
| YT-83432 | 60                 | 125    | 50/200 |
| YT-83433 | 80                 | 125    | 50/200 |
| YT-83434 | 100                | 125    | 50/200 |
| YT-83435 | 120                | 125    | 50/200 |
| YT-83436 | 150                | 125    | 50/200 |
| YT-83437 | 180                | 125    | 50/200 |
| YT-83438 | 220                | 125    | 50/200 |



- GB Abrasive disc with holes  
D Schleifpapier zum Gummiteller mit lochen  
PL Krażek ścierny z otworami  
RUS Круг шлифовальный перфорированный с липучкой  
CZ Brusný kotouč z otvorami  
H Fibertárcsa lyukakkal tépózárás  
RO Disc abraziv cu orificii  
F Disques abrasifs trous avec velcro  
I Disco abrasivo con fori  
E Juego de discos abrasivos con agujeros  
CN 圆形带孔砂纸



TIED ON CARD  
**5 PCS**  
HOOK FASTENER  
RZEP

- application: metal, wood
- abrasive: aluminium oxide
- bond: synthetic resin
- backing: C
- coating: semi-open
- zastosowanie: metal, drewno
- ścierniwo: tlenek glinu
- spoiwo: żywica syntetyczna
- podkład: C
- nasyp półotwarty

| YATO     | grit / ziarnistość | Ø (mm) |        |
|----------|--------------------|--------|--------|
| YT-83440 | 36                 | 115    | 50/200 |
| YT-83441 | 40                 | 115    | 50/200 |
| YT-83442 | 60                 | 115    | 50/200 |
| YT-83443 | 80                 | 115    | 50/200 |
| YT-83444 | 100                | 115    | 50/200 |
| YT-83445 | 120                | 115    | 50/200 |
| YT-83446 | 150                | 115    | 50/200 |
| YT-83447 | 180                | 115    | 50/200 |
| YT-83448 | 220                | 115    | 50/200 |



- GB Abrasive disc with holes  
D Schleifpapier zum Gummiteller mit lochen  
PL Krażek ścierny z otworami  
RUS Круг шлифовальный перфорированный с липучкой  
CZ Brusný kotouč z otvorami  
H Fibertárcsa lyukakkal tépózárás  
RO Disc abraziv cu orificii  
F Disques abrasifs trous avec velcro  
I Disco abrasivo con fori  
E Juego de discos abrasivos con agujeros  
CN 圆形带孔砂纸



TIED ON CARD  
**5 PCS**  
HOOK FASTENER  
RZEP

- application: metal, wood
- abrasive: aluminium oxide
- bond: synthetic resin
- backing: C
- coating: semi-open
- zastosowanie: metal, drewno
- ścierniwo: tlenek glinu
- spoiwo: żywica syntetyczna
- podkład: C
- nasyp półotwarty

| YATO     | grit / ziarnistość | Ø (mm) |        |
|----------|--------------------|--------|--------|
| YT-83450 | 36                 | 125    | 50/200 |
| YT-83451 | 40                 | 125    | 50/200 |
| YT-83452 | 60                 | 125    | 50/200 |
| YT-83453 | 80                 | 125    | 50/200 |
| YT-83454 | 100                | 125    | 50/200 |
| YT-83455 | 120                | 125    | 50/200 |
| YT-83456 | 150                | 125    | 50/200 |
| YT-83457 | 180                | 125    | 50/200 |
| YT-83458 | 220                | 125    | 50/200 |



- GB Abrasive sheet with holes  
D Schleifgewebe-scheiben mit lochen  
PL Arkusz ścierny z otworami  
RUS Шлифовальная перфорированная бумага для виброшлифмашинки  
CZ Brusné archy z otvorami  
H Csiszoló lap lyukakkal  
RO Coale (foi) abrazive cu orificii  
F Disques abrasifs trous avec velcro  
I Disco abrasivo con fori  
E Ojas abrasivas con agujeros  
CN 方形带孔砂纸



TIED ON CARD  
**5 PCS**  
HOOK FASTENER  
RZEP

- application: paint, lacquer, filler
- abrasive: aluminium oxide
- bond: synthetic resin
- backing: C
- coating: semi-open
- zastosowanie: farby, lakiery, szpachle
- ścierniwo: tlenek glinu
- spoiwo: żywica syntetyczna
- podkład: C
- nasyp półotwarty

| YATO     | grit / ziarnistość | size / rozmiar (mm) |        |
|----------|--------------------|---------------------|--------|
| YT-83480 | 40                 | 93x180              | 25/100 |
| YT-83481 | 60                 | 93x180              | 25/100 |
| YT-83482 | 80                 | 93x180              | 25/100 |
| YT-83483 | 100                | 93x180              | 25/100 |
| YT-83484 | 120                | 93x180              | 25/100 |
| YT-83485 | 150                | 93x180              | 50/200 |
| YT-83486 | 180                | 93x180              | 50/200 |
| YT-83487 | 220                | 93x180              | 50/200 |
| YT-83488 | 240                | 93x180              | 50/200 |



- GB Abrasive sheet with holes  
D Schleifgewebe-scheiben mit lochen  
PL Arkusz ścierny z otworami  
RUS Шлифовальная перфорированная бумага для виброшлифмашинки  
CZ Brusné archy z otvorami  
H Csiszoló lap lyukakkal  
RO Coale (foi) abrazive cu orificii  
F Disques abrasifs trous avec velcro  
I Disco abrasivo con fori  
E Ojas abrasivas con agujeros  
CN 方形带孔砂纸

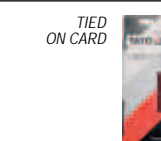

TIED ON CARD  
**5 PCS**  
HOOK FASTENER  
RZEP

- application: metal, wood
- abrasive: aluminium oxide
- bond: synthetic resin
- backing: C
- coating: semi-open
- zastosowanie: metal, drewno
- ścierniwo: tlenek glinu
- spoiwo: żywica syntetyczna
- podkład: C
- nasyp półotwarty

| YATO     | grit / ziarnistość | size / rozmiar (mm) |        |
|----------|--------------------|---------------------|--------|
| YT-83490 | 40                 | 93x230              | 25/100 |
| YT-83491 | 60                 | 93x230              | 25/100 |
| YT-83492 | 80                 | 93x230              | 25/100 |
| YT-83493 | 100                | 93x230              | 25/100 |
| YT-83494 | 120                | 93x230              | 25/100 |
| YT-83495 | 150                | 93x230              | 25/100 |
| YT-83496 | 180                | 93x230              | 25/100 |
| YT-83497 | 220                | 93x230              | 25/100 |
| YT-83498 | 240                | 93x230              | 25/100 |



# 11

## Hydraulic tools Narzędzia hydrauliczne

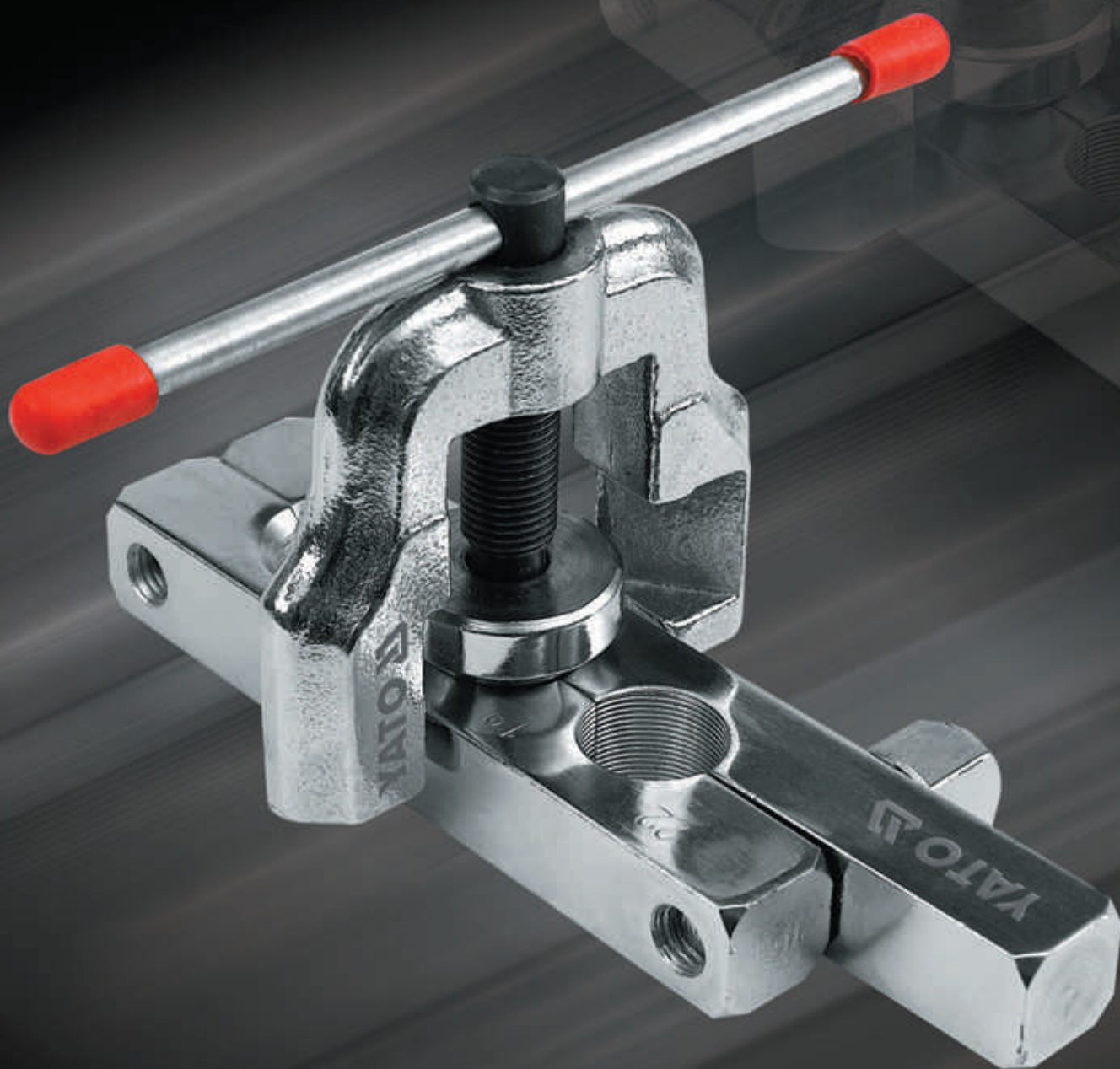



Ratchet die stock sets  
Komplety gwintownic ręcznych

224



Hand flaring tools sets  
Praski do rozszerzania rur

229



Accessories for ratchet die stock  
Akcesoria do gwintownic ręcznych

224



Burners & soldering tools  
Palniki i lutownice

230-231



Pipe wrenches  
Klucze do rur

225-226



Pipe welders  
Zgrzewarki do rur

231



Chain pipe wrenches  
Klucze do rur łańcuchowe

226



Hinged pipe vices  
Imadła zaciskowe do rur

232



Water pump pliers  
Szczypce nastawne

226



Deburrers & accessories  
Gratowniki i akcesoria

232



Pipe cutters  
Obcinaki do rur

227-228



Pipe brushes  
Szczotki do rur

232



Pipe benders  
Giętarki do rur

229



- GB Ratchet die stocks
- D Rohrgewinde-schneidsatz
- PL Zestaw gwintownic
- RUS Набор плашек
- CZ Sada závitníků
- H Menetűró készlet
- RO Trusa filiere
- F Taraud manuel
- I Filiere per tubi a mano
- E Juego de roscar
- CN 管子铰板组套



9Cr2

BMC & COLOR SLEEVE



|          |      |        |      |      |
|----------|------|--------|------|------|
| 5<br>PCS | 3/8" | 1/2"   | 3/4" | 1"   |
|          | 10mm | 12.5mm | 19mm | 25mm |

| YATO     | size / rozmiar  |   |
|----------|---|---|
| YT-29001 | 3/8" (10.0 mm); 1/2" (12.5 mm);<br>3/4" (19.0 mm); 1" (25.0 mm) | 4 |



|          |       |      |        |      |      |      |
|----------|-------|------|--------|------|------|------|
| 7<br>PCS | 1/4"  | 3/8" | 1/2"   | 3/4" | 1"   | 5/4" |
|          | 6.3mm | 10mm | 12.5mm | 19mm | 25mm | 32mm |

| YATO    | size / rozmiar   |   |
|---------|--|---|
| YT-2900 | 1/4" (6.3 mm); 3/8" (10.0 mm); 1/2" (12.5 mm);<br>3/4" (19.0 mm); 1" (25.0 mm); 5/4" (32.0 mm) | 4 |

- GB Spare knives for ratchet die stock
- D Rohrgewinde-Schneidbacken
- PL Noże zapasowe do gwintownicy ręcznej
- RUS Запасные ножи для оправки
- CZ Náhradní nože do ručního závitového
- H Tartalék kések, racsnis csőmenetvágóhoz

- RO Cutit de rezerva pt. filiera
- F Lame pour taraud à main
- I Lame di ricambio per filettatrici manuale
- E Filos de recambio para terraja de mano
- CN 板牙

4  
PCS  
9Cr2



POLYBAG WITH HEADER



| YATO    | size / rozmiar | PCS packing |        |
|---------|----------------|-------------|--------|
| YT-2910 | 1/4" (6.3 mm)  | 4           | 50/200 |
| YT-2911 | 3/8" (10.0 mm) | 4           | 50/200 |
| YT-2912 | 1/2" (12.5 mm) | 4           | 50/200 |
| YT-2913 | 3/4" (19.0 mm) | 4           | 50/200 |
| YT-2914 | 1" (25.0 mm)   | 4           | 50/200 |

- GB Spare head for ratchet die stock
- D Rohrgewinde-Schneidköpfe
- PL Głowica zapasowa do gwintownicy ręcznej
- RUS Запасная оправка для нарезания трубной резьбы
- CZ Náhradní hlava pro ruční závitověz
- H Tartalék fej, racsnis csőmenetvágóhoz
- RO Cap de rezerva pt. placa filetat cu clichei
- F Mandrin porte-taraud

- I Testina ricambio per filettatrici manuale
- E Cabeza de recambio para terraja de mano
- CN 板牙头

9Cr2



COLOR BOX





| YATO    | size / rozmiar |       |
|---------|----------------|-------|
| YT-2916 | 1/4" (6.3 mm)  | 10/40 |
| YT-2917 | 3/8" (10.0 mm) | 10/40 |
| YT-2918 | 1/2" (12.5 mm) | 10/40 |
| YT-2919 | 3/4" (19.0 mm) | 10/40 |
| YT-2920 | 1" (25.0 mm)   | 10/40 |
| YT-2921 | 5/4" (32.0 mm) | 10/40 |



- GB Pipe wrench
- D Rohrschlüssel
- PL Klucz do rur
- RUS Ключ трубный
- CZ Klíč součásti na trubky
- H Csőkulcs
- RO Cheie reglabila pt. tevi
- F Clé aux tubes
- I Chiave per tubi
- E Llave para tubos
- CN 铝合金管钳

CrMo HRC 55-60 AL HANDLE





| YATO  | size / rozmiar | max. pipe diameter / max. średnica rury |  |
|--|----------------|---|---|
| YT-2482  | 14" (350 mm)   | 2" (50 mm)                              | 6/12  |
| YT-2483  | 18" (450 mm)   | 2.5" (63 mm)                            | 2/10  |
| YT-2484  | 24" (600 mm)   | 3" (75 mm)                              | 2/6   |
| YT-2485  | 36" (900 mm)   | 5" (125 mm)                             | 3   |

- GB Pipe wrench
- D Rohrschlüssel
- PL Klucz do rur
- RUS Ключ трубный
- CZ Klíč součásti na trubky
- H Csőkulcs
- RO Cheie reglabila pt. tevi
- F Clé aux tubes
- I Chiave per tubi
- E Llave para tubos
- CN 铝合金管钳

CrMo HRC 55-60





| YATO  | size / rozmiar | max. pipe diameter / max. średnica rury |  |
|--|----------------|---|---|
| YT-2488  | 10" (250 mm)   | 1" (25 mm)                              | 6/18  |
| YT-2489  | 12" (300 mm)   | 1.5" (38 mm)                            | 6/12  |
| YT-2490  | 14" (350 mm)   | 2" (50 mm)                              | 2/10  |
| YT-2491  | 18" (450 mm)   | 2.5" (63 mm)                            | 3/6   |
| YT-2492  | 24" (600 mm)   | 3" (75 mm)                              | 2/4   |
| YT-2493  | 36" (900 mm)   | 5" (125 mm)                             | 1   |
| YT-2494  | 48" (1200 mm)  | 6" (150 mm)                             | 1   |

- GB Pipe wrench
- D Rohrschlüssel
- PL Klucz do rur
- RUS Ключ трубный
- CZ Klíč součásti na trubky
- H Csőkulcs
- RO Cheie reglabila pt. tevi
- F Clé serre-tube
- I Chiave per tubi
- E Llave para tubos
- CN 铝合金管钳

HRC 55-60 OFFSET TYPE





| YATO  | size / rozmiar | max. pipe diameter / max. średnica rury |  |
|--|----------------|---|---|
| YT-2201  | 10" (250 mm)   | 1" (25 mm)                              | 6/36  |
| YT-2203  | 14" (350 mm)   | 1.5" (38 mm)                            | 4/16  |
| YT-2204  | 18" (450 mm)   | 2" (50 mm)                              | 3/12  |
| YT-2205  | 24" (600 mm)   | 2.5" (63 mm)                            | 3/6   |
| YT-2206  | 36" (900 mm)   | 4" (100 mm)                             | 2/4   |

- GB Pipe wrench
- D Rohrschlüssel
- PL Klucz do rur
- RUS Ключ трубный
- CZ Klíč součásti na trubky
- H Csőkulcs
- RO Cheie reglabila pt. tevi
- F Clé aux tubes
- I Chiave per tubi
- E Llave para tubos
- CN 铝合金管钳

HRC 55-60 AL HANDLE



| YATO  | size / rozmiar | max. pipe diameter / max. średnica rury |  |
|--|----------------|---|---|
| YT-2222  | 12" (300 mm)   | 1" (25 mm)                              | 6/24  |
| YT-2223  | 14" (350 mm)   | 1.5" (38 mm)                            | 4/16  |
| YT-2224  | 18" (450 mm)   | 2" (50 mm)                              | 3/12  |
| YT-2225  | 24" (600 mm)   | 2.5" (63 mm)                            | 3/6   |

GB Adjustable pipe wrench  
D Rohrschlüssel  
PL Klucz nastawny do rur  
RUS Ключ трубный переставной

CZ Nastavitelný klíč na trubky  
H Állítható csőkulcs  
RO Cheie reglabilă pt. țevi  
F Clé serre-tube „suédois”

I Pinze regolabili per tubi  
E Llave para tubos tipo Inglesa  
CN 鷹嘴鉗

COLOR BOX



|          |       |          |       |
|----------|-------|----------|-------|
| 90°      | 1"    | 1.5"     | 2"    |
|          | 25 mm | 38 mm    | 50 mm |
| DIN 5234 |       | CrV 6140 |       |



| YATO    | max. pipe diameter / max. średnica rury | L (mm) |    |
|---------|---|--------|----|
| YT-2210 | 1" (25 mm)                              | 320    | 24 |
| YT-2211 | 1.5" (38 mm)                            | 420    | 18 |
| YT-2212 | 2" (50 mm)                              | 560    | 12 |

GB Adjustable pipe wrench  
D Rohrschlüssel  
PL Klucz nastawny do rur  
RUS Ключ трубный переставной

CZ Nastavitelný klíč na trubky  
H Állítható csőkulcs  
RO Cheie reglabilă pt. țevi  
F Clé serre-tube „suédois”

I Pinze regolabili per tubi  
E Llave para tubos tipo Inglesa  
CN 鷹嘴鉗

COLOR BOX



|          |       |          |       |
|----------|-------|----------|-------|
| 45°      | 1"    | 1.5"     | 2"    |
|          | 25 mm | 38 mm    | 50 mm |
| DIN 5234 |       | CrV 6140 |       |



| YATO    | max. pipe diameter / max. średnica rury | L (mm) |    |
|---------|---|--------|----|
| YT-2213 | 1" (25 mm)                              | 330    | 24 |
| YT-2214 | 1.5" (38 mm)                            | 415    | 18 |
| YT-2215 | 2" (50 mm)                              | 530    | 12 |

GB Adjustable pipe wrench  
D Rohrschlüssel  
PL Klucz nastawny do rur  
RUS Ключ трубный переставной

CZ Nastavitelný klíč na trubky  
H Állítható csőkulcs  
RO Cheie reglabilă pt. țevi  
F Clé serre-tube „suédois”

I Pinze regolabili per tubi  
E Llave para tubos tipo Inglesa  
CN 鷹嘴鉗

COLOR BOX



|          |       |          |       |
|----------|-------|----------|-------|
| S        | 1"    | 1.5"     | 2"    |
|          | 25 mm | 38 mm    | 50 mm |
| DIN 5234 |       | CrV 6140 |       |



| YATO    | max. pipe diameter / max. średnica rury | L (mm) |    |
|---------|---|--------|----|
| YT-2216 | 1" (25 mm)                              | 330    | 24 |
| YT-2217 | 1.5" (38 mm)                            | 420    | 18 |
| YT-2218 | 2" (50 mm)                              | 535    | 12 |

GB Chain pipe wrench  
D Kettenrohrzange  
PL Klucz łańcuchowy do rur  
RUS Ключ цепной для труб  
CZ Klíč řetězový na trubky  
H Lăncos csőfőgő  
RO Cheie reglabilă pt. țevi cu lant  
F Clé à chaîne  
I Chiave a catena per tubi  
E Llave de cadena  
CN 链条管子钳

CZ Nastavitelný klíč na trubky  
H Állítható csőkulcs  
RO Cheie reglabilă pt. țevi  
F Clé à chaîne  
I Chiave a catena per tubi  
E Llave de cadena  
CN 链条管子钳

I Pinze regolabili per tubi  
E Llave para tubos tipo Inglesa  
CN 鷹嘴鉗

COLOR BOX

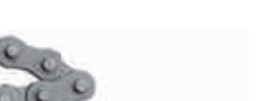

|  |        |   |
|--|--------|---|
| SLIDING CARD   | 4"     | 300 mm  |
|  | 100 mm |   |
| INDUCTION HARDENED TEETH<br>DĘBY HARTOWANE INDUKCYJNIE |        | ADJUSTABLE WORKING RANGE<br>REGULOWANY ZAKRES PRACY |



| YATO     | L (mm) | max. pipe diameter / max. średnica rury |      |
|----------|--------|---|------|
| YT-22260 | 300    | 4" (100 mm)                             | 6/24 |

GB Water pump pliers  
D Wasserpumpenzange  
PL Szczypce nastawne  
RUS Клещи переставные  
CZ Keleště siko  
H Vizpumpařagó

RO Clește papagal  
F Pince réglable  
I Pinze regolabili  
E Alicates de fontanero ajustables  
CN 水泵鉗

|        |        |     |
|--------|--------|-----|
| 250 mm | 300 mm | CrV |
|--------|--------|-----|

GB Water pump pliers  
D Wasserpumpenzange  
PL Szczypce nastawne  
RUS Клещи переставные  
CZ Keleště siko  
H Vizpumpařagó

RO Clește papagal  
F Pince réglable  
I Pinze regolabili  
E Alicates de fontanero ajustables  
CN 水泵鉗

HALF DOUBLE BLISTER

|        |                    |
|--------|--------------------|
| 250 mm | NICKEL IRON FINISH |
|--------|--------------------|



| YATO    | L (mm) |      |
|---------|--------|------|
| YT-2090 | 250    | 6/36 |
| YT-2091 | 300    | 6/36 |

GB Water pump pliers  
D Wasserpumpenzange  
PL Szczypce nastawne  
RUS Клещи переставные  
CZ Keleště siko  
H Vizpumpařagó

RO Clește papagal  
F Pince réglable  
I Pinze regolabili  
E Alicates de fontanero ajustables  
CN 水泵鉗

|  |                                 |  |
|--|---------------------------------|--|
| 250 mm   | JAW WIDTH SZEROKOŚĆ SZCZEK 6 mm | CrV                                      |
| WORKING RANGE ADJUSTMENT REGULACJA ZAKRESU PRACY |                                 | STRENGTHENED JAWS WZMOCNIANA KONSTRUKCJA |



| YATO     | L (mm) |       |
|----------|--------|-------|
| YT-20911 | 250    | 10/50 |



| YATO    | L (mm) |      |
|---------|--------|------|
| YT-2069 | 250    | 6/36 |



| YATO    | L (mm) |      |
|---------|--------|------|
| YT-2070 | 250    | 6/24 |



- GB PVC pipe cutter  
D PVC Rohrabsschneider  
PL Obcinak do rur PCV  
RUS Труборез для ПВХ труб  
CZ Řezač PVC trubek  
H Csővágó olló PVC csövekhez  
RO Clește pt. tăiat țevi din PVC  
F Coupeur aux tubes  
I Taglia tubi PVC  
E Cortatubos PVC  
CN PVC 管子割刀



max (mm) **35**  
PVC PP PU PE  
8Cr13 STAINLESS STEEL STAL NIERDZEWNA  
HRC **54**

SLIDING CARD

|             |             |      |
|-------------|-------------|------|
| <b>YATO</b> | max. Ø (mm) |      |
| YT-2230     | 35          | 6/48 |

- GB PVC pipe cutter  
D PVC Rohrabsschneider  
PL Obcinak do rur PCV  
RUS Труборез для ПВХ труб  
CZ Řezač PVC trubek  
H Csővágó olló PVC csövekhez  
RO Clește pt. tăiat țevi din PVC  
F Coupeur aux tubes  
I Taglia tubi PVC  
E Cortatubos PVC  
CN PVC 管子割刀



max (mm) **42**  
PVC PP PU PE  
8Cr13 STAINLESS STEEL STAL NIERDZEWNA  
HRC **54**  
RATCHET SYSTEM ZAPADKOWY  
QUICK RELEASE SZYBKIE ZWALNIANIE

SLIDING CARD

|             |             |      |
|-------------|-------------|------|
| <b>YATO</b> | max. Ø (mm) |      |
| YT-2231     | 42          | 6/48 |

- GB PVC pipe cutter  
D PVC Rohrabsschneider  
PL Obcinak do rur PCV  
RUS Труборез для ПВХ труб  
CZ Řezač PVC trubek  
H Csővágó olló PVC csövekhez  
RO Clește pt. tăiat țevi din PVC  
F Coupeur aux tubes  
I Taglia tubi PVC  
E Cortatubos PVC  
CN PVC 管子割刀



max (mm) **63**  
PVC PP PU PE  
8Cr13 STAINLESS STEEL STAL NIERDZEWNA  
HRC **56-58**  
RATCHET SYSTEM ZAPADKOWY  
QUICK RELEASE SZYBKIE ZWALNIANIE

SLIDING CARD

|             |             |      |
|-------------|-------------|------|
| <b>YATO</b> | max. Ø (mm) |      |
| YT-22312    | 63          | 6/24 |

- GB PVC pipe cutter  
D PVC Rohrabsschneider  
PL Obcinak do rur PCV  
RUS Труборез для ПВХ труб  
CZ Řezač PVC trubek  
H Csővágó olló PVC csövekhez  
RO Clește pt. tăiat țevi din PVC  
F Coupeur aux tubes  
I Taglia tubi PVC  
E Cortatubos PVC  
CN PVC 管子割刀



SLIDING CARD



PVC PP PU PE  
8Cr13 STAINLESS STEEL STAL NIERDZEWNA  
HRC **54**  
AI  
RATCHET SYSTEM ZAPADKOWY  
QUICK RELEASE SZYBKIE ZWALNIANIE

max (mm) **51**

|             |             |      |
|-------------|-------------|------|
| <b>YATO</b> | max. Ø (mm) |      |
| YT-2228     | 51          | 6/24 |



max (mm) **64**

|             |             |      |
|-------------|-------------|------|
| <b>YATO</b> | max. Ø (mm) |      |
| YT-2229     | 64          | 6/24 |

- GB Pipe cutter  
D Rohrabsschneider  
PL Obcinak do rur  
RUS Труборез для труб  
CZ Řezač trubek  
H Csővágó olló csövekhez  
RO Clește pt. tăiat țevi  
F Coupeurs aux tubes  
I Rullo di taglio per tubi  
E Cortatubos  
CN 管子割刀

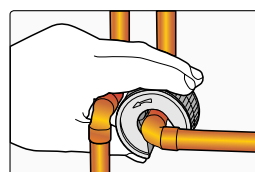

PLASTIC Al, Cu  
BEARING STEEL STAL ŁOŻYSKOWA

SLIDING CARD

|             |                |  |        |
|-------------|----------------|--|--------|
| <b>YATO</b> | Ø              | external diameter / średnica zewnętrzna (mm) |        |
| YT-22353    | 19/32" (15 mm) | 48   | 10/100 |
| YT-22354    | 23/32" (18 mm) | 59   | 10/50  |
| YT-22355    | 7/8" (22 mm)   | 56   | 10/50  |

GB Pipe cutter      CZ Řezač trubek      F Coupeur aux tubes  
 D Rohrschneider      H Csővágó olló      I Taglia tubi PVC  
 PL Obcinak do rur      csővekhez      E Cortatubos  
 RUS Труборез для труб      RO Clește pt. țăiat țevi      CN 管子割刀

COLOR BOX



Ø 1/10"-7/8"  
 Ø 3-22 mm



|             |                      |     |
|-------------|----------------------|-----|
| <b>YATO</b> | Ø                    |     |
| YT-22318    | 1/10"-7/8" (3-22 mm) | 100 |



Ø 1/10"-5/4"  
 Ø 3-32 mm

QUICK-ADJUSTMENT  
 SZYBKONASTAWNY

WITH DEBURRER  
 Z GRATOWNIKIEM



|             |                      |    |
|-------------|----------------------|----|
| <b>YATO</b> | Ø                    |    |
| YT-22338    | 1/10"-5/4" (3-32 mm) | 50 |



Ø 3/8"-1-5/8"  
 Ø 10-40 mm



|             |                        |    |
|-------------|------------------------|----|
| <b>YATO</b> | Ø                      |    |
| YT-22322    | 3/8"-1-5/8" (10-40 mm) | 20 |



Ø 1/4"-7/4"  
 Ø 6-45 mm

WITH DEBURRER  
 Z GRATOWNIKIEM



|             |                     |    |
|-------------|---------------------|----|
| <b>YATO</b> | Ø                   |    |
| YT-22333    | 1/4"-7/4" (6-45 mm) | 25 |



Ø 1/2"-5/2"  
 Ø 14-63 mm

QUICK-ADJUSTMENT  
 SZYBKONASTAWNY



|             |                      |    |
|-------------|----------------------|----|
| <b>YATO</b> | Ø                    |    |
| YT-22334    | 1/2"-5/2" (14-63 mm) | 25 |



Ø 2"-5"  
 Ø 50-127 mm

QUICK-ADJUSTMENT  
 SZYBKONASTAWNY



|             |                   |    |
|-------------|-------------------|----|
| <b>YATO</b> | Ø                 |    |
| YT-22335    | 2"-5" (50-127 mm) | 10 |

GB Replacement cutting wheel for pipe cutters  
 D Ersatzschneidrad für Rohrschneider  
 PL Zapasowe kółko tnące do obcinaka do rur  
 RUS Запасной режущий диск для труборезов  
 CZ Náhradní řezné kolečko na trubky frézy

H Tartalék vágókerék cső vágó  
 RO Roata de schimb pt. taiere țevi  
 F Molette pour coupe  
 I Taglio ruote tubo taglierina  
 E Rueda de corte de repuesto para cortatubos  
 CN 管子割刀刀片



DOUBLE BLISTER

| YATO     | a (mm) | b (mm) | c (mm) | for/dla: |        |
|----------|--------|--------|--------|----------|--------|
| YT-22313 | 18     | 6      | 4.8    | YT-2233  | 50/300 |
| YT-22314 | 26     | 14     | 7.5    | YT-2232  | 6/108  |
| YT-22315 | 18     | 6      | 4.8    | YT-22338 | 50/300 |
| YT-22316 | 27     | 6.3    | 5      | YT-2234  | 24/288 |

GB Replacement cutting wheel for pipe cutters  
 D Ersatzschneidrad für Rohrschneider  
 PL Zapasowe kółko tnące do obcinaka do rur  
 RUS Запасной режущий диск для труборезов  
 CZ Náhradní řezné kolečko na trubky frézy

H Tartalék vágókerék cső vágó  
 RO Roata de schimb pt. taiere țevi  
 F Molette pour coupe  
 I Taglio ruote tubo taglierina  
 E Rueda de corte de repuesto para cortatubos  
 CN 管子割刀刀片

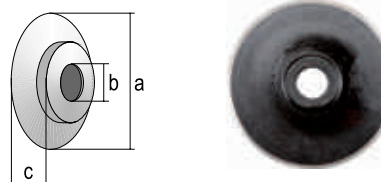

DOUBLE BLISTER

| YATO     | a (mm) | b (mm) | c (mm) | for/dla: |        |
|----------|--------|--------|--------|----------|--------|
| YT-22317 | 44     | 10.6   | 8      | YT-2235  | 12/144 |



- GB 3 in 1 mini bender  
D 3 in 1 Mini-Bieger  
PL Giętarka do rur  
RUS Мини-трубогиб 3 в 1  
CZ 3 in 1 mini ohýbačka  
H Kétkézes hajlító  
RO 3 in 1 mini dispozitiv de indoit teava

- F Cintreuse aux tubes  
I Tubo manuale bender  
E 3 in 1 mini curvadoras manuales de tubos  
CN 弯管器

|                                 |                           |                   |
|---------------------------------|---------------------------|-------------------|
| 180°                            | 1/4"                      | 5/16"             |
|                                 | 6.3mm                     | 8mm               |
| 3/8"                            | SOFT STEEL<br>MIĘKKA STAL |                   |
|                                 | 10mm                      | COPPER<br>MOSIĄDZ |
| <input type="checkbox"/> Al, Cu |                           |                   |

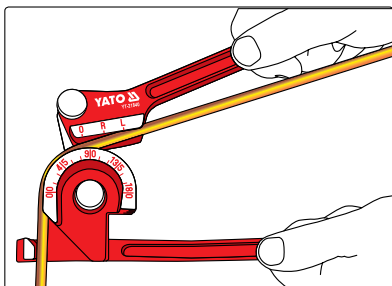

| YATO     | ∅   | Box |
|----------|---|-----|
| YT-21840 | 1/4" (6.3 mm); 5/16" (8 mm); 3/8" (10 mm) | 20  |

- GB Standard two handed bender  
D Standard-Zweihand-Bieger  
PL Giętarka do rur  
RUS Стандартный двуручный трубогиб  
CZ Standardní dvouruční ohýbačka  
H Kétkézes hajlító  
RO Dispozitiv de indoit teava

- F Cintreuse aux tubes  
I Tubo manuale bender  
E Curvadoras manuales de tubos  
CN 弯管器

|  |                           |  |
|--|---------------------------|--|
| 180°                                       | Al, Cu                    |  |
|  | SOFT STEEL<br>MIĘKKA STAL |  |
| <input type="checkbox"/> COPPER<br>MOSIĄDZ |                           |  |

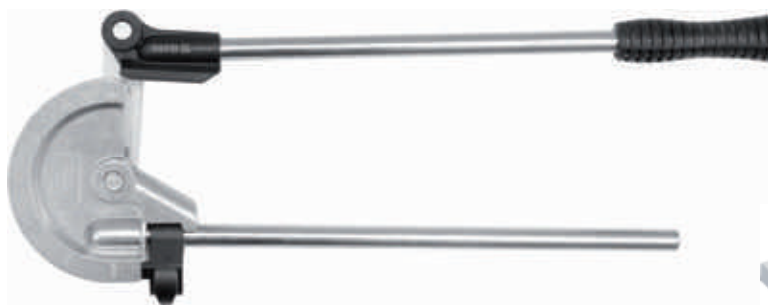
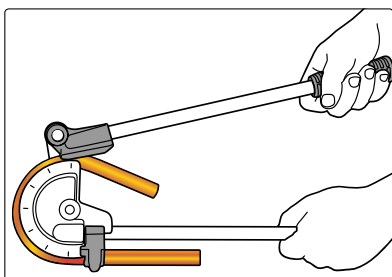

| YATO     | ∅              | Box |
|----------|----------------|-----|
| YT-21842 | 15/32" (12 mm) | 20  |
| YT-21843 | 9/16" (14 mm)  | 10  |
| YT-21844 | 9/32" (15 mm)  | 10  |
| YT-21845 | 5/8" (16 mm)   | 10  |
| YT-21846 | 23/32" (18 mm) | 10  |

- GB Hand flaring tools set  
D Handpresse zum Aufweiten von Rohren  
PL Praska do ręcznego rozszerzania rur  
RUS Пресс для ручного расширения труб  
CZ Přípravek na ruční rozšířování konců trubek  
H Kézi csőtágító  
RO Presă manuală pt. lățirea țevilor  
F Set pour étendre les tubes  
I Presa per tubi  
E Prensa para la elongación manual de tubos  
CN 扩孔器组套

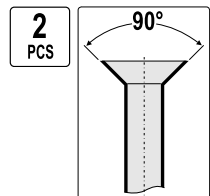

| YATO    | ∅ (mm)     | Box |
|---------|------------|-----|
| YT-2182 | 22; 25; 28 | 20  |

- GB Hand flaring tools set  
D Handpresse zum Aufweiten von Rohren  
PL Praska do ręcznego rozszerzania rur  
RUS Пресс для ручного расширения труб  
CZ Přípravek na ruční rozšířování konců trubek  
H Kézi csőtágító  
RO Presă manuală pt. lățirea țevilor  
F Set pour étendre les tubes  
I Presa per tubi  
E Prensa para la elongación manual de tubos  
CN 扩孔器组套

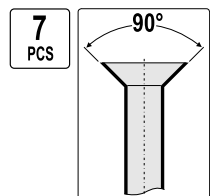

| YATO    | ∅ (mm)                             | Box |
|---------|------------------------------------|-----|
| YT-2180 | 3; 5; 6; 8; 10; 12; 14; 15; 16; 19 | 10  |

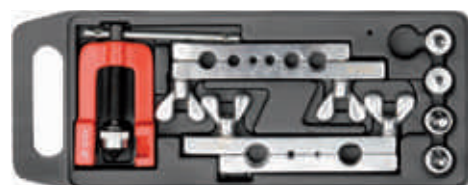

GB Gas torch  
D Gasbrenner  
PL Palnik gazowy  
RUS Газовая паяльная лампа  
CZ Plynový hořák  
H Gázégő

RO Arzător de gaz  
F Bruleur à gaz  
I Saldatore bruciatore a gas  
E Soplete de gas  
CN 火焰枪

PIEZO ELECTRIC 1350°C 60ml 200 min



YATO YT-6700 6/24

GB Gas torch  
D Gasbrenner  
PL Palnik gazowy  
RUS Газовая паяльная лампа  
CZ Plynový hořák  
H Gázégő

RO Arzător de gaz  
F Bruleur à gaz  
I Saldatore bruciatore a gas  
E Soplete de gas  
CN 火焰枪

PIEZO 30ml 60-90 min GAS GAZ LOCK BLOKADA BUTANE lighter gas BUTAN (gas do zapalniczy) CHILD PROTECTION ZABEZPECZENIE PRZED DZIECIAMI

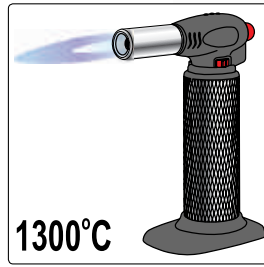

YATO YT-36700 10/20

GB Butane soldering tool  
D Gaslötkolben  
PL Lutownica gazowa  
RUS Паяльник газовый  
CZ Plynová pájka  
H Forrasztópisztoly ceruza bután gáz üzemű  
RO Surubelnita sudura cu gaz  
F Fer à souder à gaz  
I Saldatore a gas  
E Microsoldador de butano portátil  
CN 瓦斯焊接工具

1300°C 210-400°C 20ml 25-80 W 120 min



YATO W YT-6705 25-80 12/72

GB Soldering tool set  
D Gaslötkolben satz  
PL Lutownica gazowa z akcesoriami  
RUS Газовый паяльный набор  
CZ Plynova pajka souprava  
H Gaz forrasztópaka készletek

RO Set ciocan de lipit cu gaz  
F Fer à souder à gaz  
I Saldatore a gas  
E Soldador a gas con accesorios  
CN 自动点火多功能瓦斯组套

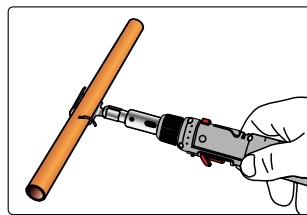

7 PCS 30-125 W 30ml 75 min GAS GAZ PIEZO LOCK BLOKADA BUTANE lighter gas BUTAN (gas do zapalniczy) PROPANE-BUTANE lighter gas PROPAN-BUTAN (gas do zapalniczy) CHILD PROTECTION ZABEZPECZENIE PRZED DZIECIAMI

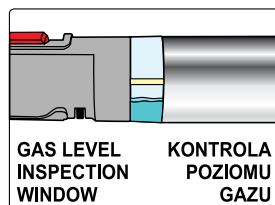
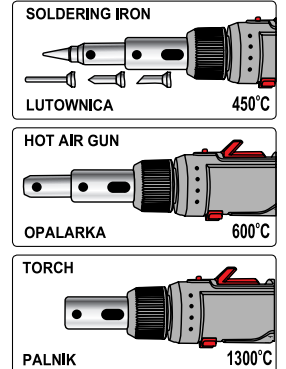

PLASTIC BOX & HANGING COLOR BOX

YATO W YT-36706 30-125 6



- GB Butane soldering tool  
D Gaslötkolben  
PL Lutownica gazowa  
RUS Паяльник газовый  
CZ Plynová pájka  
H Forrasztópisztoly ceruza  
bután gáz üzemi  
RO Surubelnita sudura cu gaz  
F Fer à souder à gaz  
I Saldatore a gas  
E Microsoldador de butano portátil  
CN 瓦斯焊接工具



|                |        |           |       |          |         |
|----------------|--------|-----------|-------|----------|---------|
| PIEZO ELECTRIC | 1300°C | 250-550°C | 38 ml | 30-125 W | 200 min |
|----------------|--------|-----------|-------|----------|---------|

SLIDING CARD



|             |        |       |
|-------------|--------|-------|
| <b>YATO</b> | W      |       |
| YT-6706     | 30-125 | 12/48 |

- GB Soldering tool 3 in 1  
D Gaslötkolben 3 in 1  
PL Lutownica gazowa 3 w 1  
RUS Газовый паяльник 3-в-1  
CZ Plynová pájka 3 in 1  
H Gaz-forrasztópaka 3 in 1  
RO Ciocan de lipit cu gaz 3 in 1  
F Fer à souder à gaz  
I Saldatore a gas  
E Soldador de gas 3 in 1  
CN 瓦斯焊接工具



|       |         |       |        |         |              |   |  |  |
|-------|---------|-------|--------|---------|--------------|---|--|--|
| PIEZO | 30~70 W | 12 ml | 60 min | GAS GAZ | LOCK BLOKADA | BUTANE lighter gas BUTAN (gaz do zapalniczki) | PROPANE-BUTANE lighter gas PROPAN-BUTAN (gaz do zapalniczki) | CHILD PROTECTION ZABEZPECZENIE PRZED DZIECIAMI |
|-------|---------|-------|--------|---------|--------------|---|--|--|

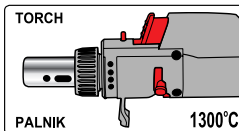
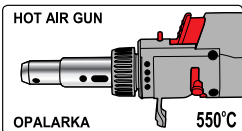
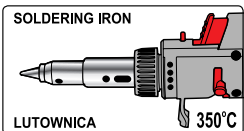

SLIDING CARD



|             |       |       |
|-------------|-------|-------|
| <b>YATO</b> | W     |       |
| YT-36704    | 30-70 | 12/72 |

- GB Gas blow torch  
D Lötbrenner  
PL Palnik gazowy  
RUS Газовая горелка  
CZ Plynový hořák  
H Gázégő
- RO Arzător de gaz  
F Bruleur à gaz  
I Saldatore bruciatore a gas  
E Soplete de gas  
CN 火焰枪

|       |         |         |               |              |              |
|-------|---------|---------|---------------|--------------|--------------|
| PIEZO | 1.28 kW | GAS GAZ | AIR POWIETRZE | LOCK BLOKADA | BUTANE BUTAN |
|-------|---------|---------|---------------|--------------|--------------|

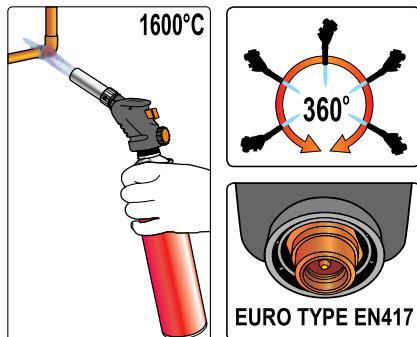

SLIDING CARD



|             |      |      |
|-------------|------|------|
| <b>YATO</b> | kW   |      |
| YT-36709    | 1.28 | 6/12 |

- GB PVC plastic pipe welder  
D Schweißgerät für thermoplastische Rohre  
PL Zgrzewarka do rur termoplastycznych  
RUS Сварочная машина для термопластиковых труба  
CZ Svářečka na termoplastické trubky  
H Hegesztő berendezés termoplasztikus csövekhez  
RO Masina de sudat tevi termoplastice
- F Soudeur en tuyauterie en PVC  
I Polifusore saldatore per tubi  
E Maquina de soldar las tubos termoplasticos  
CN 热熔器

|           |       |         |                   |            |
|-----------|-------|---------|-------------------|------------|
| 230V~50Hz | 850 W | 0-300°C | ∅ 20, 25, 32 [mm] | 40, 50, 63 |
|-----------|-------|---------|-------------------|------------|



METAL CASE & COLOR BOX



|             |     |   |
|-------------|-----|---|
| <b>YATO</b> | W   |   |
| YT-82250    | 850 | 2 |

- GB Hinged pipe vice
- D Rohrschraubstock
- PL Imadło zaciskowe do rur
- RUS Тиски для труб
- CZ Upínací svěrák na trubky
- H Satu, csőszorító
- RO Menghină pt. țevi
- F Étau de serrage à tuyaux
- I Morsa stringi tubo
- E Tornillo de apriete para tubos
- CN 管子台虎钳



S55C



COLOR BOX

| YATO    | Ø (mm) |   |
|---------|--------|---|
| YT-6510 | 60     | 4 |
| YT-6511 | 76     | 2 |
| YT-6512 | 90     | 2 |
| YT-6513 | 110    | 1 |

- GB Universal quick deburrer
- D Universal-Schnell-Entgrater
- PL Gratownik
- RUS Универсальный быстро-гратосниматель
- CZ Univerzální rychlé odhrotování
- H Univerzális gyors sorjátlanító

- RO Debavurator rapid universal
- F Ébavureur
- I Utensile di sbavatura
- E Desbarbador rápida universal
- CN 去毛刺修边器

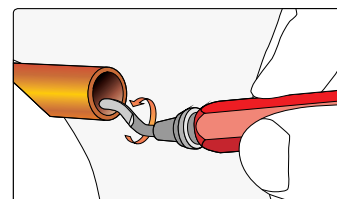

HSS M2

BODY KORPUS 12mm

EXCHANGEABLE ROTATING BLADE  
WYMIENNE OBRACANE OSTRZE



SLIDING CARD

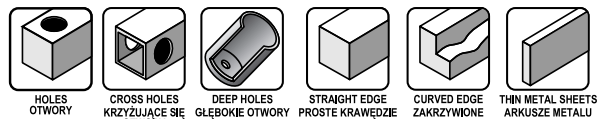

| YATO     |        |
|----------|--------|
| YT-22360 | 50/150 |

- GB Replacement blade for deburrer
- D Ersatzklinge für Entgrater
- PL Ostrza zapasowe do gratownika
- RUS Лезвие для снятия заусенцев
- CZ Náhradní čepel pro odhrotování
- H Tartalék penge sorjázásához
- RO Cuită de schimb pt. debavurare
- F Set le lames pour ébavureur
- I Set di lame per sbavatura utensile
- E Cuchilla de repuesto para desbarbar
- CN 修边器刀片

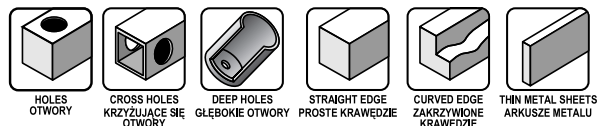

| YATO     |        |
|----------|--------|
| YT-22361 | 12/144 |

for / dla: YT-22360

- GB Copper pipe internal brush
- D Kupferrohr Innenbürste
- PL Szczotka wewnętrzna do rur miedzianych
- RUS Щетка для внутренней очистки труб
- CZ Kartač vnitřní na měděné trubky
- H Rézcső belső tisztító kefe
- RO Perii de interior pt. țevi de cupru

- F Brosse aux tubes en cuivre
- I Spazzola per il rame interno
- E Cepillo para limpieza de tubos de cobre
- CN 管子刷

STAINLESS STEEL WIRE  
DRUT ZE STALI  
NERDZEWNEJ

- GB Copper pipe brush 2 in 1
- D 2-in-1 Kupferrohrbürste für Innen- und Außenreinigung
- PL Szczotka do rur miedzianych 2 w 1
- RUS Щетка для внутренней и внешней зачистки медных труб
- CZ Kartač vnitřní a vnější na měděné trubky

- H Rézcső tisztító kefe 2 in 1
- RO Perii pt. țevi de cupru 2 in 1
- F Brosse aux tubes en cuivre
- I Spazzola per il tubi di rame 2 in 1
- E 2-en-1 cepillo para limpieza de tubos de cobre int. y ext
- CN 2合1管子刷

STAINLESS STEEL WIRE  
DRUT ZE STALI  
NERDZEWNEJ



SLIDING CARD

| YATO     | Ø (mm) |        |
|----------|--------|--------|
| YT-63701 | 15     | 12/120 |
| YT-63702 | 18     | 12/120 |
| YT-63703 | 22     | 12/120 |
| YT-63704 | 28     | 12/120 |

| YATO     | Ø (mm) |        |
|----------|--------|--------|
| YT-63705 | 15; 22 | 50/100 |





# 12

## Fastening tools Narzędzia do łączenia







|  |   |         |
|--|---|---------|
| <b>Hand riveters &amp; rivets</b><br>Nitownice ręczne i nity |  | 236-238 |
|--|---|---------|

|   |     |
|---|-----|
| <b>Hand riveters</b><br>Nitownice ręczne                  | 236 |
| <b>Lazy tong riveters</b><br>Nitownice ręczne, dźwigniowe | 236 |
| <b>Hand nut tools</b><br>Nitownice do nitonakrętek        | 237 |
| <b>Aluminium blind rivets</b><br>Nity aluminiowe          | 238 |

|   |   |     |
|---|---|-----|
| <b>Pneumatic riveters</b><br>Nitownice pneumatyczne |  | 238 |
|---|---|-----|

|   |   |     |
|---|---|-----|
| <b>Staple guns &amp; staples</b><br>Zszywacze i zszywki |  | 239 |
|---|---|-----|

|                                       |     |
|---------------------------------------|-----|
| <b>Staple guns</b><br>Zszywacze       | 239 |
| <b>Staple removers</b><br>Rozszywacze | 239 |
| <b>Staples</b><br>Zszywki             | 239 |
| <b>Nails</b><br>Gwoździe              | 239 |

|   |   |         |
|---|---|---------|
| <b>Pneumatic stitching &amp; nailing machines</b><br>Zszywacze i gwoździarki pneumatyczne |  | 240-241 |
|---|---|---------|

|  |     |
|--|-----|
| <b>Pneumatic staplers</b><br>Zszywacze pneumatyczne  | 240 |
| <b>Pneumatic nailers</b><br>Gwoździarki pneumatyczne | 240 |
| <b>Staples</b><br>Zszywki                            | 241 |
| <b>Nails</b><br>Gwoździe                             | 241 |

|  |   |     |
|--|---|-----|
| <b>Mini palm nailers</b><br>Młotki pneumatyczne do gwoździ |  | 241 |
|--|---|-----|

|  |   |     |
|--|---|-----|
| <b>Gas framing nailers &amp; accessories</b><br>Gwoździarki gazowe i akcesoria |  | 241 |
|--|---|-----|

|   |   |     |
|---|---|-----|
| <b>Foam guns</b><br>Pistolety do pianki |  | 242 |
|---|---|-----|

|   |   |     |
|---|---|-----|
| <b>Caulking guns</b><br>Wyciskacze do mas |  | 243 |
|---|---|-----|

|   |   |         |
|---|---|---------|
| <b>Burners &amp; soldering tools</b><br>Palniki i lutownice |  | 244-246 |
|---|---|---------|

|   |   |     |
|---|---|-----|
| <b>Glue guns</b><br>Pistolety do klejenia |  | 247 |
|---|---|-----|

- GB Hand riveter  
 D Blindnietzange  
 PL Nitownica ręczna  
 RUS Заклепочник  
 CZ Ruční nýtovačka  
 H Kézi pöpszegecszhúzó
- RO Presă de nituit manuală  
 F Riveteuse manuelle  
 I Rivettatrice manuale  
 E Remachadora de mano  
 CN 拉铆枪

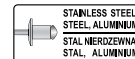

DOUBLE BLISTER

| YATO    | Ø (mm)             | L (mm) |      |
|---------|--------------------|--------|------|
| YT-3600 | 2.4; 3.2; 4.0; 4.8 | 280    | 6/24 |

- GB Hand riveter  
 D Blindnietzange  
 PL Nitownica ręczna  
 RUS Заклепочник  
 CZ Ruční nýtovačka  
 H Kézi pöpszegecszhúzó
- RO Presă de nituit manuală  
 F Riveteuse manuelle  
 I Rivettatrice manuale  
 E Remachadora de mano  
 CN 拉铆枪

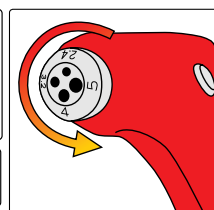
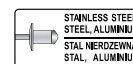
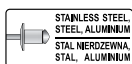

- GB Hand riveter  
 D Blindnietzange  
 PL Nitownica ręczna  
 RUS Заклепочник  
 CZ Ruční nýtovačka  
 H Kézi pöpszegecszhúzó  
 RO Presă de nituit manuală  
 F Riveteuse manuelle  
 I Rivettatrice manuale  
 E Remachadora de mano  
 CN 拉铆枪



SLIDING CARD

| YATO     | Ø (mm)             | L (mm) |       |
|----------|--------------------|--------|-------|
| YT-36011 | 2.4; 3.2; 4.0; 4.8 | 253    | 12/36 |

- GB Lazy tongue riveter  
 D Blindnietzange  
 PL Nitownica dźwigniowa  
 RUS Заклепочник  
 CZ Nýtovačka páková  
 H Emeltyűs pöpszegecszhúzó  
 RO Pcleşte pt. popnituri
- F Riveteuse à levier  
 I Rivettatrice per rivetti a strappo  
 E Remachadora de palanca  
 CN 双把手拉铆枪

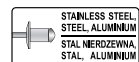

COLOR BOX

| YATO    | Ø (mm)                  | L (mm) |    |
|---------|-------------------------|--------|----|
| YT-3609 | 3.2; 4.0; 4.8; 6.0; 6.4 | 330    | 16 |

- GB Lazy tongue riveter  
 D Blindnietzange  
 PL Nitownica dźwigniowa  
 RUS Заклепочник  
 CZ Nýtovačka páková  
 H Emeltyűs pöpszegecszhúzó  
 RO Pcleşte pt. popnituri
- F Riveteuse à levier  
 I Rivettatrice per rivetti a strappo  
 E Remachadora de palanca  
 CN 双把手拉铆枪

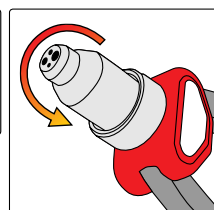
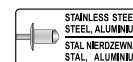

COLOR BOX

| YATO     | Ø (mm)             | L (mm) |    |
|----------|--------------------|--------|----|
| YT-36092 | 3.2; 4.0; 4.8; 6.4 | 328    | 12 |



GB Lazy tongue riveter  
D Blindnietzange  
PL Nitownica dźwigniowa  
RUS Заклепочник  
CZ Nýtovačka páková  
H Emeltyűs  
RO Pclește pt. popnituri

F Riveteuse à levier  
I Rivettatrice per rivetti  
a strappo  
E Remachadora de palanca  
CN 双把手拉铆枪



380  
mm

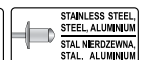

STAINLESS STEEL,  
STEEL, ALUMINIUM  
STAL, NIERZEWNIA,  
STAL, ALUMINIUM

3 JAWS  
3 SZCZĘKI

x5



CrMo



COLOR BOX

| YATO     | Ø (mm)                  | L (mm) |    |
|----------|-------------------------|--------|----|
| YT-36095 | 2.4; 3.2; 4.0; 4.8; 6.4 | 380    | 12 |

GB Lazy tongue riveter  
D Blindnietzange  
PL Nitownica dźwigniowa  
RUS Заклепочник  
CZ Nýtovačka páková  
H Emeltyűs  
RO Pclește pt. popnituri

F Riveteuse à levier  
I Rivettatrice per rivetti  
a strappo  
E Remachadora de palanca  
CN 双把手拉铆枪



525  
mm



STAINLESS STEEL,  
STEEL, ALUMINIUM  
STAL, NIERZEWNIA,  
STAL, ALUMINIUM

3 JAWS  
3 SZCZĘKI

x5



CrV



COLOR BOX

| YATO    | Ø (mm)                  | L (mm) |    |
|---------|-------------------------|--------|----|
| YT-3610 | 3.2; 4.0; 4.8; 6.0; 6.4 | 525    | 12 |

GB Hand nut tool  
D Blindnietzange  
PL Nitownica ręczna do nitonakrętek  
RUS Заклепочник  
CZ Nýtovačka páková  
H Emeltyűs  
RO Pclește pt. popnituri

F Riveteuse manuelle aux écrous  
I Rivettatrice mano rivetto  
E Remachadora de palanca  
CN 手动铆螺母枪



0~8  
mm



STAINLESS STEEL,  
STEEL, ALUMINIUM  
STAL, NIERZEWNIA,  
STAL, ALUMINIUM

x5

440  
mm



x5



COLOR BOX

| YATO    | size / rozmiar      | L (mm) |    |
|---------|---------------------|--------|----|
| YT-3613 | M4; M5; M6; M8; M10 | 440    | 10 |

GB Hand nut tool  
D Blindnietzange  
PL Nitownica ręczna do nitonakrętek  
RUS Заклепочник  
CZ Nýtovačka páková  
H Emeltyűs  
RO Pclește pt. popnituri

F Riveteuse manuelle aux écrous  
I Rivettatrice mano rivetto  
E Remachadora de palanca  
CN 手动铆螺母枪



330  
mm



STAINLESS STEEL,  
STEEL, ALUMINIUM  
STAL, NIERZEWNIA,  
STAL, ALUMINIUM

x6

0~8  
mm



x6



BMC  
& COLOR  
SLEEVE

| YATO    | size / rozmiar          | L (mm) |   |
|---------|-------------------------|--------|---|
| YT-3612 | M3; M4; M5; M6; M8; M10 | 330    | 5 |

GB Hand nut tool  
D Blindnietzange  
PL Nitownica ręczna do nitonakrętek  
RUS Заклепочник  
CZ Nýtovačka páková  
H Emeltyűs popszegecsűző  
RO Pclește pt. popnituri

F Riveteuse manuelle aux écrous  
I Rivettatrice mano rivetto  
E Remachadora de palanca  
CN 手动铆螺母枪



STAINLESS STEEL, STEEL, ALUMINIUM, STAL, NIERDZEWNIA, STAL, ALUMINIUM



| YATO     | size / rozmiar       | L (mm) |   |
|----------|----------------------|--------|---|
| YT-36119 | M5; M6; M8; M10; M12 | 338    | 6 |

GB Hand nut tool  
D Blindnietzange  
PL Nitownica ręczna do nitonakrętek  
RUS Заклепочник  
CZ Nýtovačka páková  
H Emeltyűs popszegecsűző  
RO Pclește pt. popnituri

F Riveteuse manuelle aux écrous  
I Rivettatrice mano rivetto  
E Remachadora de palanca  
CN 手动铆螺母枪



| YATO     | size / rozmiar               | L (mm) |   |
|----------|------------------------------|--------|---|
| YT-36129 | M3; M4; M5; M6; M8; M10; M12 | 410    | 5 |

GB Aluminium blind rivets  
D Aluminiumblindnieten  
PL Nity aluminiowe  
RUS Алюминиевые заклёпки

CZ Hliníkové nýty  
H Alu popszegecs  
RO Nituri din aluminiu  
F Rivets en aluminium

I Alluminio rivetti  
E Remaches de aluminio  
CN K型抽芯铝铆钉

DOUBLE BLISTER



50 PCS

Al



| YATO    | Ø (mm) | L (mm) | PCS packing |       |
|---------|--------|--------|-------------|-------|
| YT-3635 | 4.0    | 9.6    | 50          | 12/48 |
| YT-3636 | 4.0    | 12.7   | 50          | 12/48 |

12

GB Pneumatic riveting machine  
D Pneumatische Nietvorrichtung  
PL Nitownica pneumatyczna  
RUS Пневматический заклепочник  
CZ Pneumatická nýtovačka  
H Pneumatikus popszegecsűző

RO Presa pneumatica de nituti  
F Riveuse pneumatique  
I Rivettatrice pneumatica  
E Máquina remachadora  
CN 气动拉铆枪

COLOR BOX

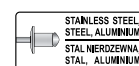

0.62 MPa



x4 • application: industry  
• przeznaczenie: przemysł

x5 • application: industry  
• przeznaczenie: przemysł

| YATO    | Ø (mm)             | L (mm) | F (kg) | F (N) |    |
|---------|--------------------|--------|--------|-------|----|
| YT-3617 | 2.4; 3.2; 4.0; 4.8 | 14     | 850    | 8335  | 10 |

| YATO    | Ø (mm)                  | L (mm) | F (kg) | F (N) |   |
|---------|-------------------------|--------|--------|-------|---|
| YT-3618 | 2.4; 3.2; 4.0; 4.8; 6.4 | 16     | 1389   | 13620 | 6 |



GB Staple gun  
D Tacker  
PL Zszywacz tapicerski  
RUS Среннеп  
CZ Čalounická  
sešivačka  
H Kárpitos tűzőgép  
RO Capsator  
tapiterie

F Agrafeuse  
tapissier  
I Cucitrice  
per tappezzerie  
E Grapadora  
de tapicero  
CN 打钉枪

DOUBLE  
BLISTER

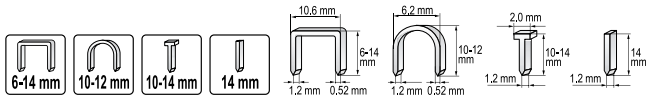
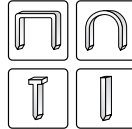

|             |       |
|-------------|-------|
| <b>YATO</b> |       |
| YT-7000     | 12/24 |

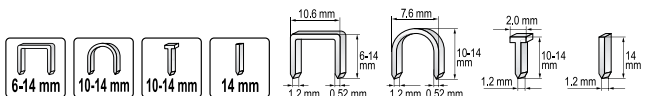

|             |       |
|-------------|-------|
| <b>YATO</b> |       |
| YT-7001     | 12/24 |

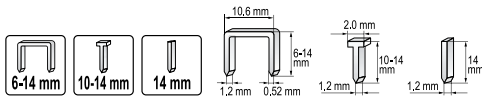

|             |      |
|-------------|------|
| <b>YATO</b> |      |
| YT-7003     | 6/24 |

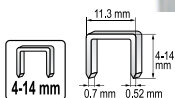

|             |       |
|-------------|-------|
| <b>YATO</b> |       |
| YT-7007     | 12/24 |

GB Staple gun  
D Tacker  
PL Zszywacz tapicerski  
RUS Среннеп  
CZ Čalounická  
sešivačka  
H Kárpitos tűzőgép  
RO Capsator  
tapiterie

F Agrafeuse  
tapissier  
I Cucitrice  
per tappezzerie  
E Grapadora  
de tapicero  
CN 打钉枪

NORMAL-MAX IMPACT FUNCTION



DOUBLE  
BLISTER

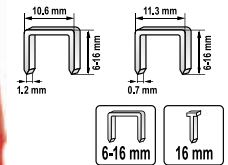

|             |                                     |      |
|-------------|-------------------------------------|------|
| <b>YATO</b> | staples size / rozmiar zszywek (mm) |      |
| YT-7005     | 10.6x6.0-16.0x1.2                   | 6/24 |

GB Hammer tackler  
D Hammer-Tacker  
PL Zszywacz młotkowy  
RUS Среннеп

CZ Čalounická sešivačka  
H Kárpitos tűzőgép  
RO Capsator tapiterie  
F Agrafeuse tapissier

I Martello cucitrice  
E Grapadora de martillo  
CN 钉锤



DOUBLE  
BLISTER

|             |       |
|-------------|-------|
| <b>YATO</b> |       |
| YT-7004     | 10/20 |

GB Staple remover  
D Klammern abwender  
PL Rozszywacz  
RUS Скобуудалитель  
CZ Rozešivač  
H Kapocskiszédő  
RO Extractor capse  
F Degrafeuse  
I Fiocco di rimozione  
E Quitagrapas  
CN 起钉器



SLIDING  
CARD

|             |        |
|-------------|--------|
| <b>YATO</b> |        |
| YT-7011     | 25/100 |

GB Staples  
D Heftklammern  
PL Zszywki  
RUS Скобы

CZ Sešivky  
H Tűzőkapocs  
RO Capse tapiterie  
F Agrafes

I Punti  
E Grapas  
CN 码钉

HANGING  
COLOR  
BOX



for / dla: YT-7000, YT-7001,  
YT-7003, YT-7004, YT-7005

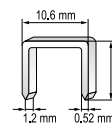

| YATO L (mm) | PCS<br>packing: |             |
|-------------|-----------------|-------------|
| YT-7022     | 6               | 1000 50/200 |
| YT-7023     | 8               | 1000 50/200 |
| YT-7024     | 10              | 1000 50/100 |
| YT-7025     | 12              | 1000 50/100 |
| YT-7026     | 14              | 1000 50/100 |



for / dla: YT-7006, YT-7007

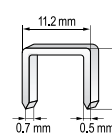

| YATO L (mm) | PCS<br>packing: |             |
|-------------|-----------------|-------------|
| YT-7051     | 6               | 1000 60/360 |
| YT-7052     | 8               | 1000 60/300 |
| YT-7053     | 10              | 1000 60/240 |
| YT-7054     | 12              | 1000 50/200 |
| YT-7055     | 14              | 1000 40/160 |

GB Nails for staple gun  
D Nageln für Yato Tacker  
PL Gwoździe do zszywacza  
RUS Гвозди для степлера  
CZ Hřebíky na sešivačku  
H Szegeka tűzőgéphez  
RO Cuie pt. capsator  
F Clous pour agrafeuses  
I Chiodi per cucitrice  
E Clavos para grapadoras  
CN 直钉

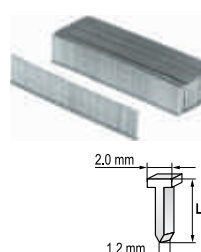

HANGING  
COLOR  
BOX



for / dla: YT-7000, YT-7001

| YATO L (mm) | PCS<br>packing: |             |
|-------------|-----------------|-------------|
| YT-7032     | 10              | 1000 50/200 |
| YT-7033     | 12              | 1000 50/200 |
| YT-7034     | 14              | 1000 50/200 |

- GB Pneumatic stitching machine
- D Drucklufthefter
- PL Zszywacz pneumatyczny
- RUS Пневматический шиватель
- CZ Pneumatická sešivačka
- H Pneumatikus tűzőgép
- RO Capsator pneumatic
- F Agrafeuse pneumatique
- I Cucitrice pneumatica
- E Engrapadora pneumática
- CN 气动码钉枪

7 bar 8-25 mm 1/4" 6.3mm



BMC & COLOR SLEEVE

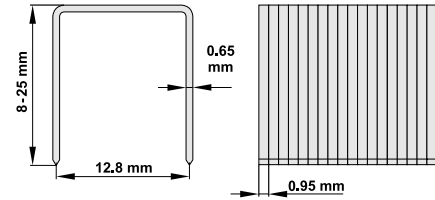

- application: industry, construction
- przeznaczenie: przemysł, budownictwo

|             |   |
|-------------|---|
| <b>YATO</b> |   |
| YT-0920     | 5 |

- GB Pneumatic nailing machine
- D Druckluftnagelgerät
- PL Gwoździarka pneumatyczna
- RUS Пневматическая гвоздильная машина
- CZ Pneumatický nastřelovač hřebíků
- H Pneumatikus szögbelevő
- RO Capsator pneumatic
- F Cloueur pneumatique
- I Chiodatrice pneumatica
- E Máquina pneumática para clavar clavos
- CN 气动码钉枪

8 bar 25-64 mm 90° 1/4" 6.3mm



BMC & COLOR SLEEVE

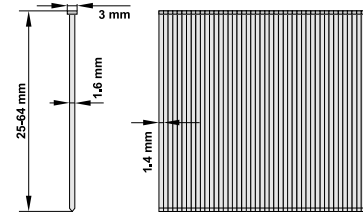

- application: industry, construction
- przeznaczenie: przemysł, budownictwo

|             |   |
|-------------|---|
| <b>YATO</b> |   |
| YT-0921     | 5 |

- GB Pneumatic nailing machine
- D Druckluftnagelgerät
- PL Gwoździarka pneumatyczna
- RUS Пневматическая гвоздильная машина
- CZ Pneumatický nastřelovač hřebíků
- H Pneumatikus szögbelevő
- RO Capsator pneumatic
- F Cloueur pneumatique
- I Chiodatrice pneumatica
- E Máquina pneumática para clavar clavos
- CN 气动码钉枪

8 bar 50-90 mm 34° 1/4" 6.3mm



BMC & COLOR SLEEVE

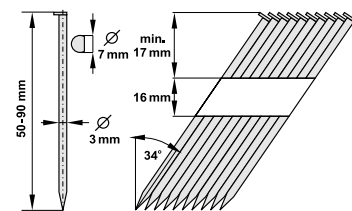

- application: industry, construction
- przeznaczenie: przemysł, budownictwo

|             |   |
|-------------|---|
| <b>YATO</b> |   |
| YT-0923     | 2 |



GB Staples  
D Heftklammern  
PL Zszywki  
RUS Скобы  
CZ Sešivky  
H Tűzőkapocs

RO Capse  
tapiterie  
F Agrafes  
I Punti  
E Grapas  
CN 码钉

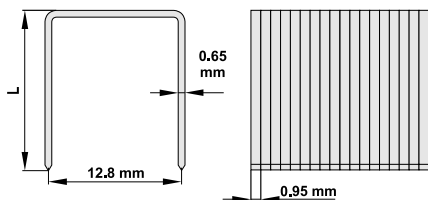

for / dla: YT-0920 COLOR BOX

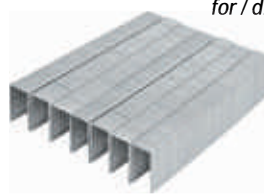

1000  
PCS

| YATO    | L (mm) | Box |
|---------|--------|-----|
| YT-0930 | 8      | 100 |
| YT-0931 | 16     | 50  |
| YT-0932 | 25     | 50  |

GB Nails  
D Nägel  
PL Gwoździe  
RUS Гвозди

CZ Hřebíky  
H Szeg  
RO Cuie  
F Clous



for / dla: YT-0921

1000  
PCS 90°

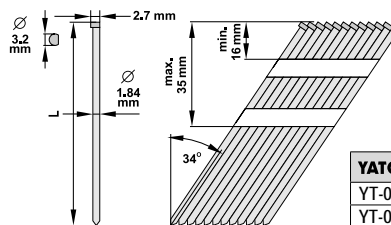

1000  
PCS 34°



for / dla: YT-0922  
COLOR BOX

| YATO    | L (mm) | Box |
|---------|--------|-----|
| YT-0938 | 38     | 20  |
| YT-0939 | 50     | 20  |
| YT-0940 | 64     | 20  |

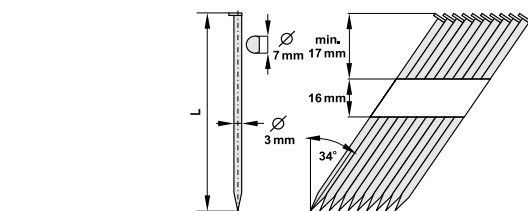

500  
PCS 34°



COLOR BOX

| YATO    | L (mm) | Box |
|---------|--------|-----|
| YT-0935 | 50     | 10  |
| YT-0936 | 75     | 10  |
| YT-0937 | 90     | 10  |

for / dla: YT-0923, YT-0927

GB Mini palm nailer  
D Drucklufthammer für Nägel  
PL Miłotek pneumatyczny do gwoździ  
RUS Пневматический молоток для забивания гвоздей  
CZ Pneumatická hřebíkovačka  
H Pneumatikus szögbeütő kalapács  
RO Ciocan pneumatic pt. cuie  
F Cloueur pneumatique  
I Chiodatrice pneumatica  
E Maquina pneumática para clavar clavos  
CN 迷你气动钉枪

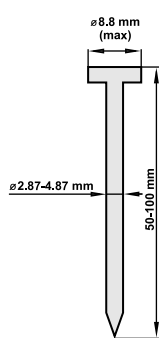

0.70  
MPa 1/4" 6.3 mm



COLOR BOX

| YATO    | Box |
|---------|-----|
| YT-0925 | 20  |

GB Gas framing nailer  
D Gas-nagler  
PL Gwoździarka gazowa  
RUS Газовая гвоздильная машина  
CZ Plynová nastřelovačka hřebíků  
H Gáztechnológias szögbeütő

RO Capsator cu gaz  
F Cloueur à gaz  
I Chiodatrice a gas  
E Clavadora de gas  
CN 瓦斯钉枪

42 bar 4000l 50-90 mm 40 g 80 ml 1200l TRIGGER LOCK BLOKADA SPUSTU

GB Gas pipe  
D Gaspatrone  
PL Tuba gazowa  
RUS Баллончик с газом  
CZ Plynová bombička  
H Gáz patron  
RO Recipient cu gaz  
F Cartouche de gaz pour clouer  
I Chiodatrici a gas  
E Tubo de gas  
CN 瓦斯管配件

40 g 80 ml FUEL CELL FOR NAILERS GAZ DO GWOŹDZIAREK

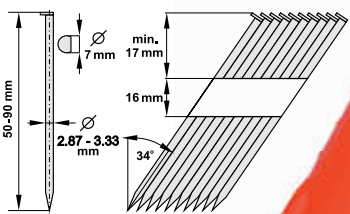

fits to / pasuje do:  
YATO, PASLÓDE,  
HITACHI, SENCO,  
POWERS, MAX, BEA

BMC & COLOR SLEEVE



| YATO    | Box |
|---------|-----|
| YT-0927 | 2   |

| YATO    | Box    |
|---------|--------|
| YT-0929 | 20/200 |

GB Foam gun  
 D Farbspritzpistole  
 PL Pistolet do pianki montażowej  
 RUS Пистолет для нанесения полиуретановой пены  
 CZ Pistole na montážní pěnu  
 H Felrakó pisztoly, poliurethán habhoz  
 RO Pistol pt. spumă

F Pistolet mousse expansive  
 I Pistola per schiuma poliuretanica  
 E Pistola para espuma de montaje de metal  
 CN 发泡枪

COLOR BOX



**PTFE**  
COATED



**YATO**    
 YT-6740 10/20



**YATO**    
 YT-6741 10/20



**YATO**    
 YT-6742 10/20



**YATO**    
 YT-6743 20



**YATO**    
 YT-6745 20



300 ml

GB Caulking gun CZ Protlačovač na hmoty I Pistola per silicone  
D Kartuschenpistole H Masszakinyomó E Pistola para masilla  
PL Wyciskacz do mas RO Pistol silicon CN 堵缝枪  
RUS Пистолет для герметика F Pistolet à feutrer



225 mm

225 mm

**YATO** L (mm)   
YT-6751 225 10/20

**YATO** L (mm)   
YT-6752 225 10/20



225 mm

225 mm

**YATO** L (mm)   
YT-6753 225 6/12

**YATO** L (mm)   
YT-6754 225 10/20



225 mm

225 mm

**YATO** L (mm)   
YT-6750 225 20/40

**YATO** L (mm)   
YT-6755 225 10/20



216 mm  
±60  
±1 mm

200 mm  
±65  
±1 mm

**YATO** L (mm)   
YT-6756 215 6/12

**YATO** L (mm)   
YT-6757 200 10/20

GB Gas torch  
D Gasbrenner  
PL Palnik gazowy  
RUS Газовая паяльная лампа  
CZ Plynový hořák  
H Gázégő

RO Arzător de gaz  
F Bruleur à gaz  
I Saldatore bruciatore a gas  
E Soplete de gas  
CN 火焰枪

PIEZO ELECTRIC 1350°C 60 ml 200 min



YATO YT-6700 6/24

GB Gas torch  
D Gasbrenner  
PL Palnik gazowy  
RUS Газовая паяльная лампа  
CZ Plynový hořák  
H Gázégő

RO Arzător de gaz  
F Bruleur à gaz  
I Saldatore bruciatore a gas  
E Soplete de gas  
CN 火焰枪

PIEZO 30 ml 60-90 min GAS GAZ LOCK BLOKADA BUTANE lighter gas BUTAN (gas do zapalniczki) CHILD PROTECTION ZABEZPECZENIE PRZED DZIECIAMI

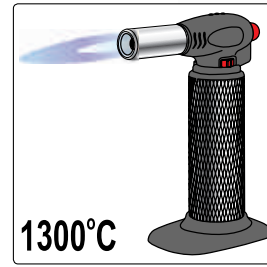

1300°C YATO YT-36700 DOUBLE BLISTER 10/20

GB Butane soldering tool  
D Gaslötkolben  
PL Lutownica gazowa  
RUS Паяльник газовый  
CZ Plynová pájka  
H Forrasztópisztoly ceruza bután gáz üzemű  
RO Surubelnita sudura cu gaz  
F Fer à souder à gaz  
I Saldatore a gas  
E Microsoldador de butano portátil  
CN 瓦斯焊接工具

1300°C 210-400°C 20 ml 25-80 W 120 min



SLIDING CARD

YATO W YT-6705 25-80 12/72

GB Soldering tool set  
D Gaslötkolben satz  
PL Lutownica gazowa z akcesoriami  
RUS Газовый паяльный набор  
CZ Plynova pajka souprava  
H Gaz forrasztópáka készletek

RO Set ciocan de lipit cu gaz  
F Fer à souder à gaz  
I Saldatore a gas  
E Soldador a gas con accesorios  
CN 自动点火多功能瓦斯组套

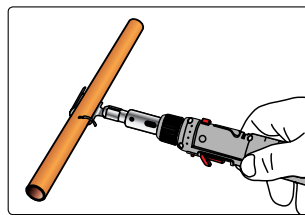

7 PCS 30-125 W 30 ml 75 min GAS GAZ PIEZO LOCK BLOKADA BUTANE lighter gas BUTAN (gas do zapalniczki) PROPANE-BUTANE lighter gas PROPAN-BUTAN (gas do zapalniczki) CHILD PROTECTION ZABEZPECZENIE PRZED DZIECIAMI

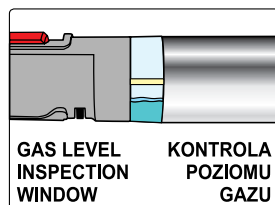
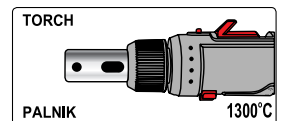
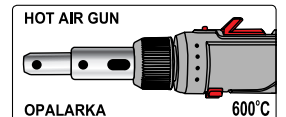
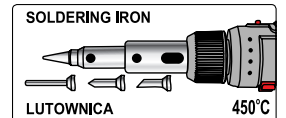

PLASTIC BOX & HANGING COLOR BOX

YATO W YT-36706 30-125 6



- GB Butane soldering tool  
D Gaslötkolben  
PL Lutownica gazowa  
RUS Паяльник газовый  
CZ Plynová pájka  
H Forrasztópisztoly ceruza bután gáz üzemű
- RO Surubelnita sudura cu gaz  
F Fer à souder à gaz  
I Saldatore a gas  
E Microsoldador de butano portàtil  
CN 瓦斯焊接工具

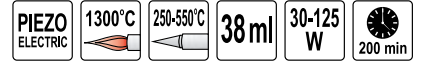

SLIDING CARD



|             |        |       |
|-------------|--------|-------|
| <b>YATO</b> | W      |       |
| YT-6706     | 30-125 | 12/48 |

- GB Soldering tool 3 in 1  
D Gaslötkolben 3 in 1  
PL Lutownica gazowa 3 w 1  
RUS Газовый паяльник 3-в-1  
CZ Plynova pájka 3 in 1  
H Gaz-forrasztópaka 3 in 1  
RO Ciocan de lipit cu gaz 3 in 1
- F Fer à souder à gaz  
I Saldatore a gas  
E Soldador de gas 3 in 1  
CN 瓦斯焊接工具

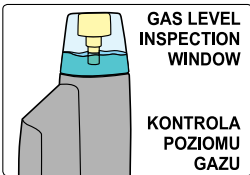
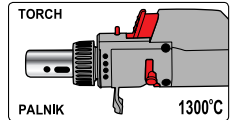
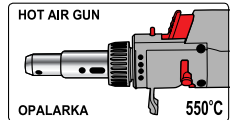
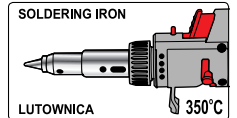

SLIDING CARD



|             |       |       |
|-------------|-------|-------|
| <b>YATO</b> | W     |       |
| YT-36704    | 30-70 | 12/72 |

- GB Gas blow torch  
D Lötbrenner  
PL Palnik gazowy  
RUS Газовая горелка  
CZ Plynový hořák  
H Gázégő
- RO Arzător de gaz  
F Bruleur à gaz  
I Saldatore bruciatore a gas  
E Soplete de gas  
CN 火焰枪

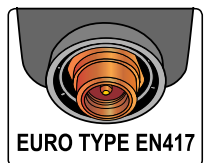
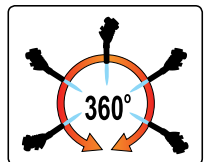
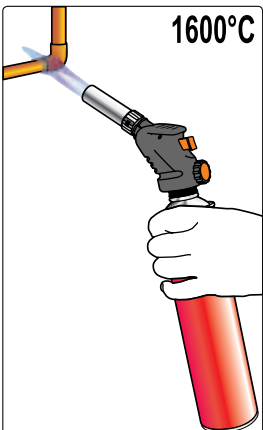

SLIDING CARD



|             |      |      |
|-------------|------|------|
| <b>YATO</b> | KW   |      |
| YT-36709    | 1.28 | 6/12 |

- GB Soldering iron
- D LötKolben
- PL Lutownica orogowa
- RUS Электропаяльник
- CZ Pájka odrogová
- H Forrasztópáka
- RO Ciocan de lipit
- F Fer à souder
- I Saldatore a stagno
- E Soldador de resistencia
- CN 电烙铁



HANGING DISPLAY COLOR BOX



230V~50Hz

| YATO    | W  | working temp. of soldering tip (°C) | dimensions of soldering tip (mm) |    |
|---------|----|-------------------------------------|----------------------------------|----|
| YT-8271 | 30 | 400                                 | ø3.8 x 70                        | 16 |
| YT-8272 | 60 | 500                                 | ø6.0 x 78                        | 16 |
| YT-8273 | 80 | 520                                 | ø6.8 x 64                        | 16 |

- GB Desoldering pump
- D Entlötsaugpumpe
- PL Odsysacz do snuy
- RUS Шприц для удаления припоя
- CZ Odráječí sací pumpa
- H Onszippantó

- RO Pompa fluidor
- F Pompe à étain
- I Pompa aspira stagno
- E Bomba desoldadora
- CN 全铝手动吸锡器

SLIDING CARD



PTFE TIP



| YATO     |         |
|----------|---------|
| YT-82742 | 100/400 |



| YATO     |         |
|----------|---------|
| YT-82743 | 100/200 |



| YATO     |        |
|----------|--------|
| YT-82744 | 50/100 |

- GB Soldering station
- D Lötstation
- PL Stacja lutownicza
- RUS Паяльная станция
- CZ Letovací stanice
- H Forrasztópáka állomás

- RO Stație de lipit
- F Station de soudage
- I Stazione digitale di saldatura
- E Estación de soldadura
- CN 数显焊台

230V~50Hz 48W 150-450 °C 7.1 mm 65 mm LCD DISPLAY

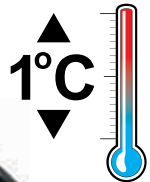

COLOR BOX



| YATO     | W  |   |
|----------|----|---|
| YT-82455 | 48 | 4 |





# 13

## Construction tools Narzędzia budowlane





Floor laminate cutters  
Gilotyny do cięcia paneli podłogowych

250



Floating rules  
Łaty

258



Tile cutting machines & accessories  
Przyrządy do cięcia glazury i akcesoria

250-252



Knives  
Noże

258



Profile gauges  
Wzorniki profili

253



Electric hoists  
Elektryczne wciągarki linowe

259



Scrapers  
Szpachelki

253



Extension cords  
Przedłużacze elektryczne

260-261



Masonry tools  
Narzędzia tynkarskie i murarskie

254-255



Mixers  
Mieszadła

262



Floats

Pace..... 254

Trowels

Kielnie..... 255

Plaster scrubbers

Żdzieraki do tynków..... 255

Pencils

Ołówki

262-263



Roofwork tools

Narzędzia dekarские

256-257



Carpenter's pencils

Ołówki stolarskie..... 262

Masonry pencils

Ołówki murarskie..... 262

GB Floor laminate cutter  
 D Laminat-Schneider  
 PL Gilotylna do cięcia paneli podłogowych  
 RUS Гильотина для ламината  
 CZ Nůžky na laminátové plovoucí podlahy

H Laminált padló vágógép  
 RO Aparat de taiat parchet laminat  
 F Guillotine pour couper les panneaux  
 I Ghigliottina per taglio dei pannelli  
 E Guillotina cortapaneles  
 CN 木地板切割器

|                                 |  |
|---------------------------------|--|
| CARBON STEEL<br>STAL<br>WĘGLOWA | 12 max.<br>CUTTING THICKNESS<br>mm<br>GRUBOŚĆ CIĘCIA |
| ZINC PLATED<br>CYNKOWANA        | 205 max.<br>CUTTING LENGTH<br>mm<br>DŁUGOŚĆ CIĘCIA   |

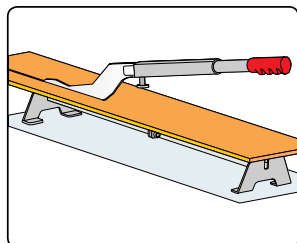
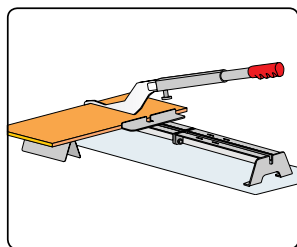
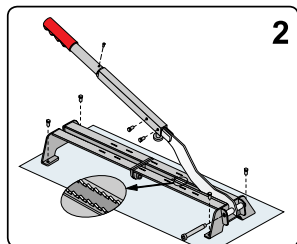
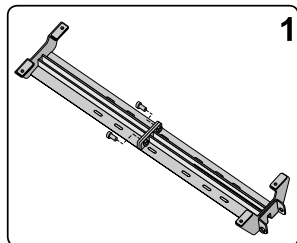

COLOR BOX



|             |   |
|-------------|---|
| <b>YATO</b> |  |
| YT-3730     | 4   |

13

GB Tile cutting machine  
 D Fliesenschnidmaschine  
 PL Przystroj do cięcia glazury  
 RUS Плиткопоз  
 CZ Přístroj na řezání glazury  
 H Csempevágó

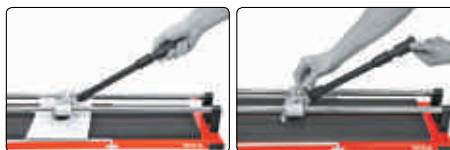
RO Instrument de tăiere a glazurei  
 F Coupeuse pour la céramique  
 I Ghigliottina per taglio di piastrelle  
 E Cortadora de gres  
 CN 瓷砖切割轮



|   |                          |   |
|---|--------------------------|---|
| CUTTING<br>CIĘCIE<br>±45°                                     | 14 mm<br>max.<br>I       |  |
| YG6X<br>TUNGSTEN CARBIDE TYP<br>OSTROJE Z WĘGLOWĄ<br>WOLFRAMU | COATED<br>TiN<br>POWŁOKA |  |



COLOR BOX



|             |        |   |
|-------------|--------|---|
| <b>YATO</b> | L (mm) |  |
| YT-3701     | 600    | 2   |
| YT-3702     | 700    | 2   |



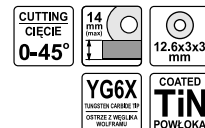

GB Tile cutting machine  
D Fliesenschnidmaschine  
PL Przyrząd do cięcia glazury  
RUS Плиткорез  
CZ Přístroj na řezání glazury  
H Csempevágó

RO Instrument de tăiere a glazurei  
F Coupeuse pour la céramique  
I Ghigliottina per taglio di piastrelle  
E Cortadora de gres  
CN 瓷砖切割轮



COLOR BOX



| YATO  | L (mm) |  |
|--|--------|---|
| YT-3703  | 630    | 2   |

GB Tile cutting wheel  
D Schneiderrad  
PL Kółko tnące wymienne  
RUS Ролик для плиткореза

CZ Výměnné kolečko  
H Cserégörgő csavarral  
RO Cuțit rolă  
F Molette coupante avec barre

I Lama di ricambio tondo  
E Recambio de cuchillo redondo  
CN 硬质合金刀片

SLIDING CARD



for / dla: YT-3700, YT-3701, YT-3702



for / dla: YT-3703



| YATO  |  |
|--|---|
| YT-3712  | 50/250  |

| YATO  |  |
|--|---|
| YT-3713  | 50/200  |



GB Tile cutting machine  
D Fliesenschnidmaschine  
PL Przyrząd do cięcia glazury  
RUS Плиткорез  
CZ Přístroj na řezání glazury  
H Csempevágó  
RO Instrument de tăiere a glazurei

F Coupeuse pour la céramique  
I Ghigliottina per taglio di piastrelle  
E Cortadora de gres  
CN 瓷砖切割轮



COLOR BOX



| YATO  | L (mm) |  |
|--|--------|---|
| YT-3704  | 600    | 1   |
| YT-3705  | 900    | 1   |



GB Tile cutting machine  
D Fliesenschnidmaschine  
PL Przyrząd do cięcia glazury  
RUS Плиткорез  
CZ Přístroj na řezání glazury  
H Csempevágó

RO Instrument de tăiere a glazurei  
F Coupeuse pour la céramique  
I Ghigliottina per taglio di piastrelle  
E Cortadora de gres  
CN 瓷砖切割轮



COLOR BOX



| YATO  | L (mm) |  |
|--|--------|---|
| YT-3706  | 500    | 2   |
| YT-3707  | 600    | 2   |
| YT-3708  | 800    | 2   |

GB Tile cutting wheel  
D Schneiderrad  
PL Kółko tnące wymienne  
RUS Ролик для плиткореза  
CZ Výměnné kolečko  
H Cserégörgő csavarral  
RO Cuțit rolă  
F Molette coupante  
I Rotella di taglio  
E Recambio de cuchillo redondo  
CN 瓷砖切割轮



SLIDING CARD



| YATO  |  |
|--|---|
| YT-3714  | 50/200  |

for / dla: YT-3704, YT-3705, YT-3706, YT-3707, YT-3708

GB Tile cutting pliers  
D Glasurzange  
PL Szczypce do cięcia i łamania glazury  
RUS Кусачки для плитки  
CZ Kleště do glazury

H Csempefogó  
RO Cleste rupt faianta  
F Pince grès mosaïque  
I Tenaglia per piastrelle  
E Tenazas para azulejos  
CN 瓷磚鉗

200 mm YG-6X



SLIDING CARD

|             |        |      |
|-------------|--------|------|
| <b>YATO</b> | L (mm) |      |
| YT-37160    | 200    | 6/36 |

GB Tile cutting pliers  
D Glasurzange  
PL Szczypce do glazury  
RUS Кусачки для плитки  
CZ Kleště do glazury  
H Csempefogó

RO Cleste rupt faianta  
F Pince grès mosaïque  
I Tenaglia per piastrelle  
E Tenazas para azulejos  
CN 瓷磚鉗

215 mm 17 mm

CUT CIECIE YG6X



SLIDING CARD

|             |        |      |
|-------------|--------|------|
| <b>YATO</b> | L (mm) |      |
| YT-37163    | 215    | 6/36 |

GB Tile cutting pliers  
D Glasurzange  
PL Szczypce do łamania glazury  
RUS Кусачки для плитки  
CZ Kleště do glazury  
H Csempefogó

RO Cleste rupt faianta  
F Pince grès mosaïque  
I Tenaglia per piastrelle  
E Tenazas para azulejos  
CN 瓷磚鉗

200 mm 2x YG-6X

COATED TiN POWLOKA



SLIDING CARD

|             |        |      |
|-------------|--------|------|
| <b>YATO</b> | L (mm) |      |
| YT-37161    | 200    | 6/36 |

GB Tile cutting pliers  
D Glasurzange  
PL Szczypce do glazury  
RUS Кусачки для плитки  
CZ Kleště do glazury  
H Csempefogó

RO Cleste rupt faianta  
F Pince grès mosaïque  
I Tenaglia per piastrelle  
E Tenazas para azulejos  
CN 瓷磚鉗

200 mm YG6X

SLIDING CARD



|             |        |      |
|-------------|--------|------|
| <b>YATO</b> | L (mm) |      |
| YT-37164    | 200    | 6/60 |

GB Tile cutting pliers  
D Glasurzange  
PL Szczypce do glazury  
RUS Скребок для плитки  
CZ Kleště do glazury  
H Csempefogó

RO Cleste rupt faianta  
F Pince grès mosaïque  
I Tenaglia per piastrelle  
E Rascador para juntas  
CN 瓷磚鉗

215 mm 17 mm

CUT CIECIE YG6X



SLIDING CARD

|             |        |      |
|-------------|--------|------|
| <b>YATO</b> | L (mm) |      |
| YT-37162    | 215    | 6/36 |

GB Grout remover  
D Fugenreiniger  
PL Skrobak do fug  
RUS Скребок для швов кладки  
CZ Skrabák na spáry  
H Fugakihúzó

RO Răzuitoare pt. rosturi  
F Gratteur pour fugues  
I Raschietto per fuga piastrelle  
E Rascador para juntas  
CN 砂浆去除器



SLIDING CARD

|             |        |       |
|-------------|--------|-------|
| <b>YATO</b> | L (mm) |       |
| YT-37170    |        | 10/60 |



GB Profile gauge  
D Profilmuster  
PL Wzornik profili  
RUS Шаблон профилей  
CZ Profilová šablona

H Profilsablon  
RO Șablon profile  
F Jauges d'épaisseurs métriques

I Profilato  
E Plantilla de perfiles  
CN 轮廓仪



SLIDING  
CARD





44  
mm

1.5  
mm



| YATO  | L (mm) |  |
|--|--------|---|
| YT-3735  | 125    | 24/72   |

| YATO  | L (mm) |  |
|--|--------|---|
| YT-3736  | 260    | 10/40   |

GB Scraper  
D Spachtel  
PL Szpachelka



RUS Шпатель  
CZ Špachtle  
H Spatula

RO Șpaclu  
F Riflard  
I Spatola

E Espatula  
CN 油灰刀

Mn  
65



| YATO  | W (mm) |  |
|--|--------|---|
| YT-5250  | 30     | 12/240  |
| YT-5251  | 40     | 12/240  |
| YT-5252  | 50     | 12/240  |
| YT-5253  | 60     | 12/240  |
| YT-5254  | 80     | 12/240  |
| YT-5255  | 100    | 12/240  |

GB Trowel for silicone  
D Spachtel für Silikon  
PL Szpachelka do silikonu  
RUS Шпатель для

силикона  
CZ Špachtle na silikon  
H Spachli szilikonhoz  
RO Spatulă pt. silicon

F Spatule à silicone  
I Spatola per silicone  
E Espátula para silicona  
CN 橡塑刮板

TPR



HANGING  
CARD





| YATO  |  |
|--|---|
| YT-5260  | 20/300  |



4  
PCS

SLIDING  
CARD



| YATO  |  |
|--|---|
| YT-5261  | 20/200  |



4  
PCS

SLIDING  
CARD



| YATO  |  |
|--|---|
| YT-5262  | 20/200  |

- GB Smooth float  
D Schweizer Glättkelle  
PL Paca gładka  
RUS Тёрка гладкая  
CZ Hladitko rovné  
H Glettväs rozsdamentes  
RO Gletiera
- F Truelle inoxidable  
I Frattazzo liscio  
E Llana para enlucido  
CN 不锈钢砌墙刀



• made of special cold rolled stainless steel sheet with elasticity factor up to 2000 N/mm  
• części robocze ze specjalnej zimnowalcowanej blachy nierdzewnej o sprężystości do 2000 N/mm

| YATO    | mm      |    |
|---------|---------|----|
| YT-5200 | 270x130 | 30 |

- GB Float with teeth  
D Zahnkelle  
PL Paca zębata  
RUS Тёрка с зубами  
CZ Hladitko zuby  
H Glettväs fogazott  
RO Gletiera zimtata  
F Truelle inoxidable
- I Frattazzo dentato  
E Llana dentada  
CN 不锈钢砌墙刀



• made of special cold rolled stainless steel sheet with elasticity factor up to 2000 N/mm  
• części robocze ze specjalnej zimnowalcowanej blachy nierdzewnej o sprężystości do 2000 N/mm

| YATO    | teeth / zęby | mm      |    |
|---------|--------------|---------|----|
| YT-5202 | 6x6          | 275x130 | 30 |
| YT-5203 | 8x8          | 270x130 | 30 |
| YT-5204 | 10x10        | 260x130 | 30 |

- GB Smooth float  
D Schweizer Glättkelle  
PL Paca tynkarska  
RUS Тёрка гладкая  
CZ Hladitko rovné  
H Glettväs rozsdamentes  
RO Gletiera  
F Truelle inoxidable
- I Frattazzo  
E Llana para enlucido  
CN 不锈钢砌墙刀



• made of special cold rolled stainless steel sheet with elasticity factor up to 2000 N/mm  
• części robocze ze specjalnej zimnowalcowanej blachy nierdzewnej o sprężystości do 2000 N/mm

| YATO    | mm      |    |
|---------|---------|----|
| YT-5207 | 380x130 | 40 |
| YT-5209 | 480x130 | 10 |
| YT-5210 | 580x130 | 10 |

- GB Sharp ground float  
D Steinholzglätter  
PL Paca ostra  
RUS Стальная острая тёрка  
CZ Hladitko ocelové, špičaté  
H Aljzatsimitó  
RO Gletiera cu varf ascutit  
F Truelle acier  
I Frattazzo acuto  
E Llana pontiaguda  
CN 不锈钢砌墙刀



| YATO    | mm  |    |
|---------|-----|----|
| YT-5212 | 500 | 20 |

- GB Smooth float  
D Glättkelle  
PL Paca wenecka  
RUS Тёрка венецианская  
CZ Hladitko rovné  
H Glettväs rozsdamentes lágy fogantyúval  
RO Gletiera  
F Truelle acier
- I Frattazzo  
E Llana puntas redondas  
CN 不锈钢砌墙刀



• made of special cold rolled stainless steel sheet with elasticity factor up to 2000 N/mm  
• części robocze ze specjalnej zimnowalcowanej blachy nierdzewnej o sprężystości do 2000 N/mm

| YATO    | mm     |    |
|---------|--------|----|
| YT-5214 | 200x80 | 20 |

- GB Smooth float  
D Glättkelle  
PL Paca wenecka  
RUS Тёрка венецианская  
CZ Hladitko rovné  
H Glettväs rozsdamentes lágy fogantyúval  
RO Gletiera  
F Truelle trapézoidale
- I Frattazzo  
E Llana puntas redondas  
CN 不锈钢砌墙刀



• made of special cold rolled stainless steel sheet with elasticity factor up to 2000 N/mm  
• części robocze ze specjalnej zimnowalcowanej blachy nierdzewnej o sprężystości do 2000 N/mm

| YATO    | mm        |    |
|---------|-----------|----|
| YT-5216 | 75x95x240 | 20 |

- GB Abrasive float "Rasp" type  
D Styropor-Schleifbrett  
PL Paca ścierna do styropianu  
RUS Шлифовальная тёрка "рашпиль"  
CZ Škrabák na porobeton  
H Csiszoló polystyrol habhoz  
RO Gletiera abraziva  
F Flotteur abrasif à styrofoam  
I Frattazzo abrasivo
- E Llana abrasiva para polietileno  
CN 磨砂型砌墙刀



| YATO    | mm      |    |
|---------|---------|----|
| YT-5218 | 165x370 | 20 |

- GB Stripping knife  
D Flachenspachtel  
PL Szpachla fasadowa  
RUS Стальной шпатель  
CZ Štěrka fasádní  
H Spatulya fali (rákli)  
RO Spaclu inox  
F Spatule inoxydable
- I Spatola per facciata  
E Espátula de fachada  
CN 剥皮刀



• made of special cold rolled stainless steel sheet with elasticity factor up to 2000 N/mm  
• części robocze ze specjalnej zimnowalcowanej blachy nierdzewnej o sprężystości do 2000 N/mm



| YATO    | mm  |    |
|---------|-----|----|
| YT-5226 | 250 | 20 |
| YT-5228 | 350 | 20 |
| YT-5230 | 500 | 20 |

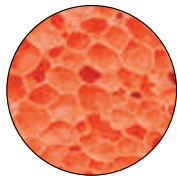
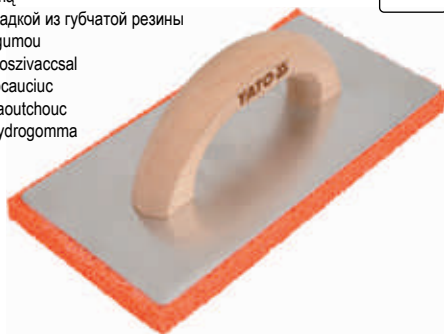

- GB Aluminium float with hydromat  
D Alu-schwammblett mit Hydrogummi  
PL Paca aluminiowa z hydrogumą  
RUS Терка алюминиевая с накладкой из губчатой резины  
CZ Hladitko aluminiové s hydrogumou  
H Fugázó alumíniumtestű hidroszivacsos  
RO Gletiera de aluminiu cu hidrocauciuc  
F Truelle en aluminium avec caoutchouc  
I Frattazzo in alluminio con idrogomma  
E Talocha aluminio con hidrogoma  
CN 橡胶砌墙刀

AI





|   |         |   |
|---|---------|---|
| <b>YATO</b>  | mm      |  |
| YT-5302   | 130x270 | 12  |

- GB Aluminium float with sponge  
D Alu-schwammblett mit Schwamm  
PL Paca aluminiowa z gąbką  
RUS Терка алюминиевая с накладкой из поролона  
CZ Hladitko aluminiové s hydrohoubou  
H Fugázó alumíniumtestű szivacsos  
RO Gletiera de aluminiu cu burete  
F Truelle en aluminium avec éponge  
I Frattazzo in alluminio con spugna  
E Talocha aluminio con esponja  
CN 橡胶砌墙刀

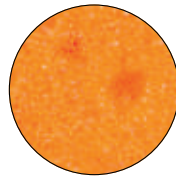
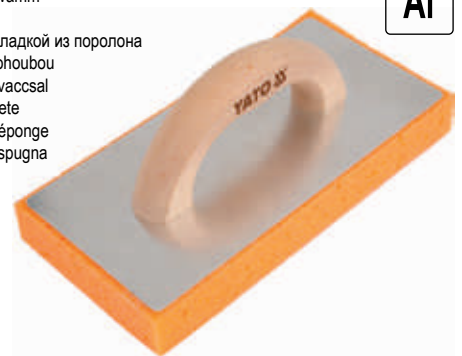
AI





|   |         |   |
|---|---------|---|
| <b>YATO</b>  | mm      |  |
| YT-5304   | 130x270 | 12  |

- GB Triangular trowel  
D Maurerkelle  
PL Kielnia trójkątna  
RUS Треугольный мастерок  
CZ Lžice trojúhelníková  
H Kőműves kanál háromszögletű  
RO Mistrie triunghi  
F Truelle  
I Cazzuola punta triangolare  
E Paleta triangular  
CN 不锈钢砌墙刀

STAINLESS  
STEEL  
STAL  
NIERDZEWNA



• made of special cold rolled stainless steel sheet with elasticity factor up to 2000 N/mm  
• części robocze ze specjalnej zimnowalcowanej blachy nierdzewnej o sprężystości do 2000 N/mm



|   |         |   |
|---|---------|---|
| <b>YATO</b>  | mm      |  |
| YT-5234   | 200x190 | 10  |

- GB Trapezoid trowel  
D Stukkateurkelle  
PL Kielnia trapezowa  
RUS Трапецидальный мастерок  
CZ Lžice zednická  
H Kőműves kanál rozsdamentes  
RO Mistrie  
F Truelle trapézoidale  
I Cazzuola punta trapezio  
E Paleta trapezoidal  
CN 不锈钢砌墙刀

STAINLESS  
STEEL  
STAL  
NIERDZEWNA



• made of special cold rolled stainless steel sheet with elasticity factor up to 2000 N/mm  
• części robocze ze specjalnej zimnowalcowanej blachy nierdzewnej o sprężystości do 2000 N/mm



|   |            |   |
|---|------------|---|
| <b>YATO</b>  | mm         |  |
| YT-5237   | 120x180x80 | 10  |

- GB Trapezoid trowel  
D Stukkateurkelle  
PL Kielnia trapezowa  
RUS Трапецидальный мастерок  
CZ Lžice zednická  
H Kőműves kanál rozsdamentes  
RO Mistrie  
F Truelle trapézoidale  
I Cazzuola punta trapezio  
E Paleta trapezoidal  
CN 不锈钢砌墙刀

STAINLESS  
STEEL  
STAL  
NIERDZEWNA



• made of special cold rolled stainless steel sheet with elasticity factor up to 2000 N/mm  
• części robocze ze specjalnej zimnowalcowanej blachy nierdzewnej o sprężystości do 2000 N/mm



|   |           |   |
|---|-----------|---|
| <b>YATO</b>  | mm        |  |
| YT-5240   | 165x80x55 | 20  |

- GB Stucco trowel  
D Gipserspachtel  
PL Kielnia „Podkowa”  
RUS Штукатурный мастерок  
CZ Lžice vymazávací  
H Gittelő kanál rozsdamentes  
RO Mistrie  
F Truelle en stuc  
I Cazzuola punta tonda  
E Paleta para estucado  
CN 不锈钢砌墙刀

STAINLESS  
STEEL  
STAL  
NIERDZEWNA



• made of special cold rolled stainless steel sheet with elasticity factor up to 2000 N/mm  
• części robocze ze specjalnej zimnowalcowanej blachy nierdzewnej o sprężystości do 2000 N/mm



|   |         |   |
|---|---------|---|
| <b>YATO</b>  | mm      |  |
| YT-5242   | 100x130 | 20  |
| YT-5243   | 80x110  | 20  |

- GB Stucco sharp trowel  
D Putzkelle  
PL Kielnia ostra  
RUS Кельма заостренная треугольная  
CZ Lžice pokrývácská  
H Gittelő kanál rozsdamentes  
RO Mistrie cu cioc ascuțit  
F Truelle  
I Cazzuola punta acuta  
E Paleta pontiaguda  
CN 不锈钢砌墙刀

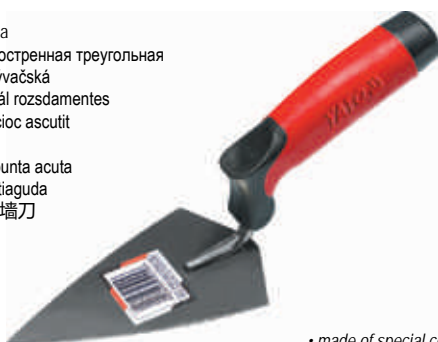
STAINLESS  
STEEL  
STAL  
NIERDZEWNA





• made of special cold rolled stainless steel sheet with elasticity factor up to 2000 N/mm  
• części robocze ze specjalnej zimnowalcowanej blachy nierdzewnej o sprężystości do 2000 N/mm

|   |        |   |
|---|--------|---|
| <b>YATO</b>  | mm     |  |
| YT-5245   | 135x80 | 20  |

- GB Plaster scrubber  
D Alu-Rabott  
PL Zdzierak do tynków  
RUS Треугольный мастерок для каменщиков  
CZ Skrabák  
H Vakolat gyalu alu késes  
RO Gletiera abraziva  
F Enleveur du badigeon  
I Utensile per sgrassare  
E Rascador para enlucido  
CN 石膏去除器

AI



|   |        |   |
|---|--------|---|
| <b>YATO</b>  | mm     |  |
| YT-5247   | 450x90 | 25  |

GB Tin snips  
D Blechscherer  
PL Nożyce do cięcia blachy  
RUS Ножницы по металлу

CZ Nůžky na plech  
H Lemezvágo olló  
RO Foarfece pt. tablă  
F Cisaille à tôle

I Cesoie per lamiere  
E Tijeras para chapas  
CN 铁皮剪

SLIDING CARD



**DROP FORGED KUTE**

**HRC 58-61**



**LEFT CUT**  
CIECIE LEWE

| YATO    | L (mm) | cutting length (mm) | cutting capacities (mm) |                   |                  |                     | 6/24 |
|---------|--------|---------------------|-------------------------|-------------------|------------------|---------------------|------|
|         |        |                     | copper                  | cold-rolled steel | hard steel HRC35 | stainless steel 304 |      |
| YT-1900 | 260    | 30                  | 0.94                    | 0.78              | 0.60             | 0.45                |      |



**RIGHT CUT**  
CIECIE PRAWIE

| YATO    | L (mm) | cutting length (mm) | cutting capacities (mm) |                   |                  |                     | 6/24 |
|---------|--------|---------------------|-------------------------|-------------------|------------------|---------------------|------|
|         |        |                     | copper                  | cold-rolled steel | hard steel HRC35 | stainless steel 304 |      |
| YT-1901 | 260    | 30                  | 0.94                    | 0.78              | 0.60             | 0.45                |      |



**LEFT CUT**  
CIECIE LEWE

| YATO    | L (mm) | cutting length (mm) | cutting capacities (mm) |                   |                  |                     | 6/24 |
|---------|--------|---------------------|-------------------------|-------------------|------------------|---------------------|------|
|         |        |                     | copper                  | cold-rolled steel | hard steel HRC35 | stainless steel 304 |      |
| YT-1902 | 300    | 50                  | 0.94                    | 0.78              | 0.60             | 0.45                |      |



**STRAIGHT CUT**  
CIECIE PROSTE

| YATO    | L (mm) | cutting length (mm) | cutting capacities (mm) |                   |                  |                     | 6/36 |
|---------|--------|---------------------|-------------------------|-------------------|------------------|---------------------|------|
|         |        |                     | copper                  | cold-rolled steel | hard steel HRC35 | stainless steel 304 |      |
| YT-1925 | 225    | 52                  | 0.94                    | 0.78              | 0.60             | 0.45                |      |

GB Tin snips  
D Blechscherer  
PL Nożyce do cięcia blachy  
RUS Ножницы по металлу  
CZ Nůžky na plech  
H Lemezvágo olló

RO Foarfece pt. tablă  
F Cisaille à tôle  
I Cesoie per lamiere  
E Tijeras para chapas  
CN 铁皮剪



SLIDING CARD



**HRC 60-62**

**CrMo**

**90°**

**SERRATED EDGES**  
ZABKOWANA KRAWĘDZ OSTRZY



**LEFT CUT**  
CIECIE LEWE



**RIGHT CUT**  
CIECIE PRAWIE

| YATO    | L (mm) | cutting length (mm) | cutting capacities (mm) |                   |                  |                     | 6/36 |
|---------|--------|---------------------|-------------------------|-------------------|------------------|---------------------|------|
|         |        |                     | copper                  | cold-rolled steel | hard steel HRC35 | stainless steel 304 |      |
| YT-1913 | 225    | 30                  | 0.78                    | 0.53              | 0.46             | 0.36                |      |

| YATO    | L (mm) | cutting length (mm) | cutting capacities (mm) |                   |                  |                     | 6/36 |
|---------|--------|---------------------|-------------------------|-------------------|------------------|---------------------|------|
|         |        |                     | copper                  | cold-rolled steel | hard steel HRC35 | stainless steel 304 |      |
| YT-1914 | 225    | 30                  | 0.78                    | 0.53              | 0.46             | 0.36                |      |



GB Portable nothers  
D Schere zum Ausschneiden von Ecken  
PL Nożyce do wycinania naroży  
RUS Ножницы для наружных углов  
CZ Nůžky na vystřihování rohů  
H Sarokkivágó olló  
RO Foarfeca pt. taierea colturilor

F Ciseaux pour le coupage des coins  
I Cesioie per taglio reggetta in angoli  
E Tijera para esquinas  
CN 截角器

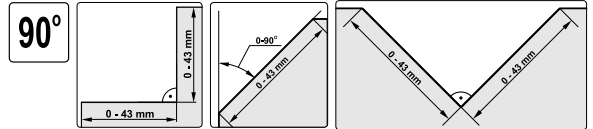

| YATO    | L (mm) |    |
|---------|--------|----|
| YT-1939 | 300    | 15 |

GB Straight pliers  
D Zange zum Blechbiegen  
PL Kleszcze do gięcia blach  
RUS Клещи с тупым ножом для жести  
CZ Kleště na ohýbání plechu  
H Falcfogó  
RO Cleste pt. indoirea tablei  
F Pince à fléchir la tôle

I Taglie per la lamiera  
E Tenazas para doblar hojalata  
CN 钣金钳

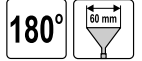

| YATO    | L (mm) |       |
|---------|--------|-------|
| YT-5416 | 280    | 10/20 |

| YATO    | L (mm) |       |
|---------|--------|-------|
| YT-5417 | 260    | 10/20 |

| YATO    | L (mm) |       |
|---------|--------|-------|
| YT-5415 | 280    | 10/20 |

GB Single seam clencher  
D Klemme für Einfachfalz  
PL Zaciskacz rąbka pojedynczego  
RUS Зажим отдельного фальца  
CZ Uzavírač jednoduché drážky  
H Falclezáró fogó  
RO Clema pt. falt simplu  
F Plieur manuel tôle (rebord singulier)  
I Griffa  
E Pinza para costura individual  
CN 屋顶施工工具

GB Double seam clencher  
D Klemme für Doppelfalz  
PL Zaciskacz rąbka podwójnego  
RUS Зажим двойного фальца  
CZ Uzavírač dvojité drážky  
H Duplafalclezáró fogó  
RO Clema pt. falt dublu  
F Plieur manuel tôle (rebord double)  
I Griffa  
E Pinza para costura doble  
CN 屋顶施工工具

GB Eaves turner  
D Kantvorrichtung für Dachtraufe  
PL Kantownik okapu  
RUS Угольник навеса  
CZ Ohýbačka okapnice  
H Ereszperemező fogó  
RO Cornier streasina  
F Cintreuse d'avant-toit  
I Griffa  
E Volteador de alero  
CN 屋顶施工工具

GB Eaves clencher  
D Klemme für Dachtraufe  
PL Zaciskacz okapu  
RUS Зажим навеса  
CZ Uzavírač okapnice  
H Ereszperemező fogó  
RO Clema pt. streasina  
F Cintreuse d'avant-toit  
I Griffa  
E Pinza para alero  
CN 屋顶施工工具



| YATO    | Ø (mm) pipe / rurki | mm      |   |
|---------|---------------------|---------|---|
| YT-5400 | 18                  | 480x220 | 5 |



| YATO    | Ø (mm) pipe / rurki | mm      |   |
|---------|---------------------|---------|---|
| YT-5402 | 18                  | 480x220 | 5 |



| YATO    | Ø (mm) pipe / rurki | mm      |   |
|---------|---------------------|---------|---|
| YT-5404 | 18                  | 450x200 | 5 |



| YATO    | Ø (mm) pipe / rurki | mm      |   |
|---------|---------------------|---------|---|
| YT-5405 | 18                  | 450x200 | 5 |

GB Drainpipe hooks bender  
D Biegewerkzeug für Dachrinnenhaken  
PL Zaginacz haków rynnowych  
RUS Прибор для загибання крюков для водосточних желобов  
CZ Ohýbačka okapových háků  
H Ereszcsatorna-tartóvas hajlító  
RO Dispozitiv pt. îndoite cârlige burlan  
F Cintreuse pour crochets de gouttière  
I Utensile per gancio  
E Herramienta para doblar los ganchos para canalones  
CN 弯管器



| YATO    | L (mm) |   |
|---------|--------|---|
| YT-5410 | 680    | 4 |

GB Rectangular floating rule  
D Setzlatte 2 Libellen  
PL Łata murarska  
RUS Правило-уровень

CZ Lat' zednická s libelami  
H Ólesléc, téglalap keresztmetszetű  
RO Dreptar cu 2 bule  
F Niveau à bulle

I Livella  
E Nivel de albanil  
CN 刮板



ACCURACY  
0.057"  
= 1 mm/m  
2  
PRECISION  
VIALS



| YATO    | L (mm) |    |
|---------|--------|----|
| YT-3071 | 1500   | 10 |
| YT-3072 | 2000   | 10 |
| YT-3073 | 2500   | 10 |
| YT-3074 | 3000   | 10 |



| YATO    | L (mm) |    |
|---------|--------|----|
| YT-3076 | 1500   | 10 |
| YT-3077 | 2000   | 10 |
| YT-3078 | 2500   | 10 |
| YT-3079 | 3000   | 10 |

GB Trapezoid floating rule  
D Abziehlatte mit Trapezprofil  
PL Łata tynkarska  
RUS Правило трапециевидное

CZ Lat' mališská  
H Ólesléc, trapézoid keresztmetszetű  
RO Dreptar trapezoidal  
F Niveau à bulle

I Livella trapezoidale  
E Nivel de albanil  
CN 梯形刮板



| YATO    | L (mm) |    |
|---------|--------|----|
| YT-3081 | 1500   | 10 |
| YT-3082 | 2000   | 10 |
| YT-3083 | 2500   | 10 |
| YT-3084 | 3000   | 10 |

GB Knife for roofing paper  
D Messer zum Schneiden von Pappe  
PL Nóż do cięcia papy  
RUS Нож для резки рубероида  
CZ Nůž k řezání lepenky  
H Kátrányapapírvágó olló  
RO Cutter pt. tăierea cartonului asfaltat  
F Couteau pour carton  
I Coltello per tagliare cartone bituminoso  
E Cuchilla para cortar cartón alquitranado  
CN 多功能刀



90 mm  
STAINLESS  
STEEL  
STAL  
NEROZŹEWNA

SLIDING  
CARD

| YATO    | L (mm) |       |
|---------|--------|-------|
| YT-7620 | 230    | 12/60 |

GB Knife for mineral wool  
D Messer zum Schneiden von Bausisolierungen  
PL Nóż do cięcia izolacji budowlanych  
RUS Нож для резки строительной изоляции

CZ Nůž k řezání stavebních izolačních hmot  
H Kés épületszigetelés vágásához  
RO Cutter pt. tăierea izolațiilor  
F Couteau pour isolants

I Coltello per tagliare l'isolamento di costruzione  
E Cuchilla para cortar aislamiento de construcción  
CN 多功能刀

SLIDING  
CARD



350 mm  
STAINLESS  
STEEL  
STAL  
NEROZŹEWNA

335 mm  
STAINLESS  
STEEL  
STAL  
NEROZŹEWNA

| YATO    | L (mm) |       |
|---------|--------|-------|
| YT-7623 | 500    | 10/50 |

| YATO    | L (mm) |       |
|---------|--------|-------|
| YT-7624 | 480    | 10/50 |

GB Thermal knife for polystyrene foam  
D Thermomesser für Styropor  
PL Nóż termiczny do styropianu  
RUS Термонож для пенопласта

CZ Termický nůž na pěnový polystyrén  
H Polisztirol vágó hőkés  
RO Cuțit termic pt. stiropian  
F Couteau thermique à styrofoam

I Coltello termico per polistirolo  
E Cuchilla térmica para poliestireno  
CN 热切割刀

230V~50Hz  
220 W  
70-450 °C  
POLYSTYRENE  
STIROPIAN  
POLYPROPYLENE  
POLIPROPILEN  
PVC  
LED



COLOR BOX



| YATO     | W   | L (mm) |    |
|----------|-----|--------|----|
| YT-82190 | 220 | 220    | 10 |

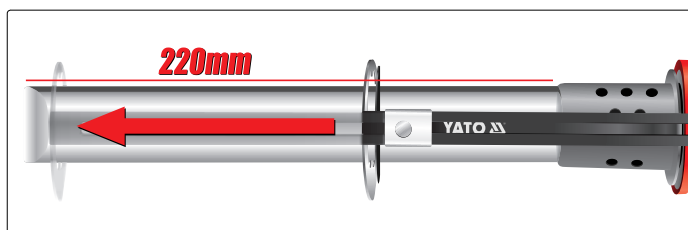
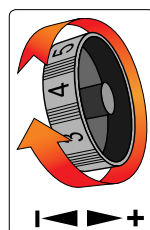



























- GB Electric hoist
- D Elektro-Seilwinde
- PL Elektryczny wciągnik linowy
- RUS Электрическая канатная лебёдка
- CZ Elektrický naviják kladkostroj
- H Elektromos csőróló
- RO Troliu electric cu cablu
- F Treuil électrique à corde
- I Verricello elettrico
- E Cabría eléctrica de cuerdas
- CN 电动葫芦



COLOR BOX





|   |   |   |
|---|---|---|
| <b>500W</b>   |  |  |
|  |  |  |
| YT-5901   | 2   |  |
| <b>550W</b>   |  |  |
|  |  |  |
| YT-5902   | 2   |  |
| <b>900W</b>   |  |  |
|  |  |  |
| YT-5904   | 2   |  |
| <b>1050W</b>  |  |  |
|  |  |  |
| YT-5905   | 2   |  |

GB Rubber protection extension cord  
 D Gummiisolierte Verlängerungsschnur  
 PL Przedłużacz w osłonie gumowej  
 RUS Удлинитель с резиновой изоляцией  
 CZ Prodlužovací kabel s gumovou izolací  
 H Gumi szigetelésű hosszabbító  
 RO Cablu prelungitor cauciuc  
 F Rallonge électrique  
 I Prolunga in gomma  
 E Cable de extensión con protección de caucho  
 CN 电缆延长线

**IP44** **16A**

CABLE **H05RR-F** KABEL  
**3G1.5 mm<sup>2</sup>**  
CABLE / KABEL

   
TYPE / TYP TYPE / TYP

**230V~50Hz**





| YATO     | L (m) |  |
|----------|-------|---|
| YT-81021 | 10    | 8   |
| YT-81022 | 20    | 4   |
| YT-81023 | 30    | 4   |
| YT-81024 | 40    | 2   |

GB Rubber protection extension cord  
 D Gummiisolierte Verlängerungsschnur  
 PL Przedłużacz w osłonie gumowej  
 RUS Удлинитель с резиновой изоляцией  
 CZ Prodlužovací kabel s gumovou izolací  
 H Gumi szigetelésű hosszabbító  
 RO Cablu prelungitor cauciuc  
 F Rallonge électrique  
 I Prolunga in gomma  
 E Cable de extensión con protección de caucho  
 CN 电缆延长线

**IP44** **16A**

CABLE **H05RR-F** KABEL  
**3G2.5 mm<sup>2</sup>**  
CABLE / KABEL

   
TYPE / TYP TYPE / TYP

**230V~50Hz**





| YATO    | L (m) |  |
|---------|-------|---|
| YT-8100 | 20    | 4   |
| YT-8101 | 30    | 2   |
| YT-8102 | 40    | 2   |

13

GB Rubber protection extension cord  
 D Gummiisolierte Verlängerungsschnur  
 PL Przedłużacz w osłonie gumowej  
 RUS Удлинитель с резиновой изоляцией  
 CZ Prodlužovací kabel s gumovou izolací  
 H Gumi szigetelésű hosszabbító  
 RO Cablu prelungitor cauciuc  
 F Rallonge électrique  
 I Prolunga in gomma  
 E Cable de extensión con protección de caucho  
 CN 电缆延长线

**IP44** **16A**

CABLE **H07RN-F** KABEL  
**3G1.5 mm<sup>2</sup>**  
CABLE / KABEL

   
TYPE / TYP TYPE / TYP

**230V~50Hz**





| YATO    | L (m) |  |
|---------|-------|---|
| YT-8110 | 2     | 40  |
| YT-8111 | 5     | 16  |
| YT-8112 | 10    | 8   |

GB Rubber protection extension cord  
 D Gummiisolierte Verlängerungsschnur  
 PL Przedłużacz w osłonie gumowej  
 RUS Удлинитель с резиновой изоляцией  
 CZ Prodlužovací kabel s gumovou izolací  
 H Gumi szigetelésű hosszabbító  
 RO Cablu prelungitor cauciuc  
 F Rallonge électrique  
 I Prolunga in gomma  
 E Cable de extensión con protección de caucho  
 CN 电缆延长线

**IP44** **16A**

CABLE **H07RN-F** KABEL  
**3G1.5 mm<sup>2</sup>**  
CABLE / KABEL

   
TYPE / TYP TYPE / TYP

**230V~50Hz**



| YATO     | L (m) |  |
|----------|-------|---|
| YT-8115  | 2     | 10  |
| YT-8116  | 10    | 4   |
| YT-81162 | 20    | 4   |



GB Cable reel  
D Kabeltrommel  
PL Przedłużacz zwijany  
RUS Удлинитель электрический  
CZ Bubnový prodloužovač  
H Kábeldob  
RO Prelungitor pe tambur  
F Rallonge électrique sur tambour enrouleur  
I Avvolgicavo con bobina  
E Cable de prolongación de tambor  
CN 电缆延长线



|                           |   |
|---------------------------|---|
| IP44                      | 16A                                       |
| CABLE<br>H05RR-F<br>KABEL | 3G1.5<br>mm <sup>2</sup><br>CABLE / KABEL |
| E & F<br>TYPE / TYP       | E<br>TYPE / TYP                           |
| 230V~<br>50Hz             |   |

•  $P_{max} = 1000\text{ W}$  coiled  
 $P_{max} = 1000\text{ W}$  zwinięty  
•  $P_{max} = 3000\text{ W}$  uncoiled  
 $P_{max} = 3000\text{ W}$  rozwinięty

| YATO     | L (m) |  |
|----------|-------|---|
| YT-81052 | 20    | 2   |
| YT-81053 | 30    | 2   |
| YT-81054 | 40    | 2   |

GB Cable reel  
D Kabeltrommel  
PL Przedłużacz zwijany  
RUS Удлинитель электрический  
CZ Bubnový prodloužovač  
H Kábeldob  
RO Prelungitor pe tambur  
F Rallonge électrique sur tambour enrouleur  
I Avvolgicavo con bobina  
E Cable de prolongación de tambor  
CN 电缆延长线



|                                     |   |
|-------------------------------------|---|
| IP44                                | 16A                                       |
| CABLE<br>H05RR-F<br>KABEL           | 3G2.5<br>mm <sup>2</sup><br>CABLE / KABEL |
| E & F<br>TYPE / TYP                 | E<br>TYPE / TYP                           |
| PLASTIC REEL<br>BEBEN<br>PLASTIKOVY | 230V~<br>50Hz                             |

•  $P_{max} = 1200\text{ W}$  coiled  
 $P_{max} = 1200\text{ W}$  zwinięty  
•  $P_{max} = 3600\text{ W}$  uncoiled  
 $P_{max} = 3600\text{ W}$  rozwinięty

| YATO    | L (m) |  |
|---------|-------|---|
| YT-8106 | 30    | 1   |
| YT-8107 | 40    | 1   |
| YT-8108 | 50    | 1   |

GB Drum power extension cord  
D Verlängerungstrommel für Kraftstrom  
PL Przedłużacz bębnowy silowy  
RUS Силовой удлинитель барабанного типа  
CZ Prodloužovací kabel silový na bubnu  
H Háromfázisú hosszabbító dob  
RO Derulator cu tambur  
F Rallonge électrique sur tambour enrouleur  
I Avvolgicavo di forza  
E Cilindro de extensión de fuerza  
CN 电缆延长线



|                           |   |
|---------------------------|---|
| IP44                      | ~400V<br>~230V                            |
| CABLE<br>H07RN-F<br>KABEL | 5G2.5<br>mm <sup>2</sup><br>CABLE / KABEL |
| 3P+N+E                    | 3P+N+E<br>2x 3P+E                         |

• ~230V; 2P+E  
 $P_{max} = 1200\text{ W}$  coiled  
 $P_{max} = 1200\text{ W}$  zwinięty  
 $P_{max} = 3000\text{ W}$  uncoiled  
 $P_{max} = 3000\text{ W}$  rozwinięty

• ~400V; 3P+N+E  
 $P_{max} = 3000\text{ W}$  coiled  
 $P_{max} = 3000\text{ W}$  zwinięty  
 $P_{max} = 9000\text{ W}$  uncoiled  
 $P_{max} = 9000\text{ W}$  rozwinięty

| YATO    | L (m) |  |
|---------|-------|---|
| YT-8120 | 25    | 1   |

GB Cup mixer  
D Korbbrüher für klumpige, zähe Materialien  
PL Mieszadło koszykowe

RUS Краскомешалка  
CZ Košíkové míchadlo  
H Kosaras keverő  
RO Mixer pt. vopsea - tip pahar

F Malaxeur  
I Mescolatore  
E Agitador de cesta  
CN 搅拌器



- application: powder materials, sealing compounds, gypsum surface finishing mixes, self-leveling mortars
- zastosowanie: materiały sypkie, masy uszczelniające, gładzie szpachlowe, zaprawy samopoziomujące

| YATO    | Ø (mm) | L (mm) | shank /<br>uchwyt | max. mixing capacity /<br>max. wydajność mieszania (kg) | ☐  |
|---------|--------|--------|-------------------|---|----|
| YT-5483 | 100    | 600    | SDS+              | 10-20   | 18 |

GB Spiral bar mixer  
D Rundstabrührer für klebrige, geschmeidige Materialien  
PL Mieszadło spiralne prętowe

RUS Краскомешалка  
CZ Spirálové míchadlo drátové  
H Spirális, pálcás keverő  
RO Malaxor pt. vopsea

F Malaxeur spiral  
I Mescolatore spirale  
E Agitador pala/cinta  
CN 搅拌器



- application: powder materials, general-purpose adhesives, gypsum surface finishing mixes, epoxy grouts
- zastosowanie: materiały sypkie, gotowe zaprawy klejowe, masy szpachlowe, zaprawy do spoinowania

| YATO    | Ø (mm) | L (mm) | shank /<br>uchwyt | max. mixing capacity /<br>max. wydajność mieszania (kg) | ☐  |
|---------|--------|--------|-------------------|---|----|
| YT-5490 | 85     | 410    | HEX               | 4-9   | 30 |
| YT-5491 | 100    | 600    | HEX               | 6-16  | 16 |
| YT-5492 | 85     | 450    | SDS+              | 4-9   | 30 |
| YT-5493 | 100    | 600    | SDS+              | 6-16  | 16 |

GB Spiral mixer  
D Rondenrührer für dünnflüssige Materialien  
PL Mieszadło spiralne

RUS Краскомешалка  
CZ Spirálové míchadlo  
H Spirális keverő  
RO Malaxor pt. vopsea

F Malaxeur spiral  
I Mescolatore spirale  
E Agitador de cinta helicoidal  
CN 搅拌器



- application: emulsion paints, acrylic paints, lacquers, stains, other liquid materials
- zastosowanie: farby emulyjne, farby akrylowe, lakiery, bejce, inne materiały płynne

| YATO    | Ø (mm) | L (mm) | shank /<br>uchwyt | max. mixing capacity /<br>max. wydajność mieszania (kg) | ☐  |
|---------|--------|--------|-------------------|---|----|
| YT-5494 | 80     | 400    | HEX               | 5-10  | 30 |
| YT-5496 | 100    | 600    | SDS+              | 15-30   | 20 |

GB Double spiral mixer  
D Wendelrührer für klebrige, zähe Materialien  
PL Mieszadło spiralne podwójne

RUS Краскомешалка  
CZ Spirálové míchadlo dvojité  
H Dupla spirális keverő  
RO Malaxor spirala dubla pt. vopsea

F Malaxeur spiral double  
I Mescolatore a doppia spirale  
E Agitador de cinta helicoidal doble  
CN 搅拌器



- application: general-purpose adhesives, masonry mortars, jointless floors, thin-layer mineral plasters, gypsum surface finishing mixes, isolation masses
- zastosowanie: zaprawy klejowe, zaprawy murarskie, jastrych, tynki strukturalne, masy szpachlowe, masy izolacyjne

| YATO    | Ø (mm) | L (mm) | shank /<br>uchwyt | max. mixing capacity /<br>max. wydajność mieszania (kg) | ☐  |
|---------|--------|--------|-------------------|---|----|
| YT-5497 | 70     | 400    | HEX               | 5-10  | 20 |
| YT-5499 | 100    | 600    | HEX               | 10-20   | 16 |
| YT-5500 | 120    | 600    | HEX               | 15-25   | 14 |
| YT-5501 | 100    | 600    | SDS+              | 10-20   | 16 |
| YT-5502 | 120    | 600    | SDS+              | 15-25   | 14 |
| YT-5503 | 120    | 600    | M14               | 15-25   | 14 |
| YT-5504 | 160    | 600    | M14               | 20-30   | 8  |

GB Triple spiral mixer  
D Wendelrührer für schwere, zähe Materialien  
PL Mieszadło spiralne potrójne

RUS Краскомешалка  
CZ Spirálové míchadlo trojité  
H Tripla spirális keverő  
RO Malaxor spirala tripla pt. vopsea

F Malaxeur spiral triple  
I Mescolatore a triplo spirale  
E Agitador de cinta helicoidal triple  
CN 搅拌器



- application: mortars, concrete, plasters, other semi-fluid materials with sand or gravel filling
- zastosowanie: zaprawy, beton, tynki, inne półpłynne, lepkie materiały z wypełnieniem piaskowym lub żwirowym

| YATO    | Ø (mm) | L (mm) | shank /<br>uchwyt | max. mixing capacity /<br>max. wydajność mieszania (kg) | ☐  |
|---------|--------|--------|-------------------|---|----|
| YT-5505 | 100    | 600    | HEX               | 10-20   | 16 |
| YT-5506 | 120    | 600    | SDS+              | 15-25   | 12 |
| YT-5507 | 120    | 600    | M14               | 15-25   | 12 |
| YT-5508 | 160    | 600    | M14               | 20-30   | 8  |

GB Carpenter's pencil  
D Zimmermannsbleistift  
PL Ołówek stolarski  
RUS Карандаш столярный

CZ Tesařská tužka  
H Asztalos ceruza  
RO Creion de tâmplărie  
F Crayon menuisier

I Matita per falegnami  
E Lapiz de carpintero  
CN 木工铅笔

COLOR BOX



144 PCS HB



| YATO    | L (mm) | W (mm) | PCS<br>packing: | ☐ |
|---------|--------|--------|-----------------|---|
| YT-6925 | 245    | 15     | 144             | 8 |



| YATO    | L (mm) | W (mm) | PCS<br>packing: | ☐ |
|---------|--------|--------|-----------------|---|
| YT-6926 | 245    | 12     | 144             | 8 |

GB Masonry pencil  
D Maurerbleistift  
PL Ołówek murarski  
RUS Карандаш каменщика

CZ Tužka zednická  
H Kőműves keverő  
RO Creion  
F Crayon maçon

I Matita per muratori  
E Lapiz de albañil  
CN 木工铅笔

COLOR BOX



144 PCS HB



| YATO    | L (mm) | W (mm) | PCS<br>packing: | ☐ |
|---------|--------|--------|-----------------|---|
| YT-6927 | 245    | 12     | 144             | 8 |



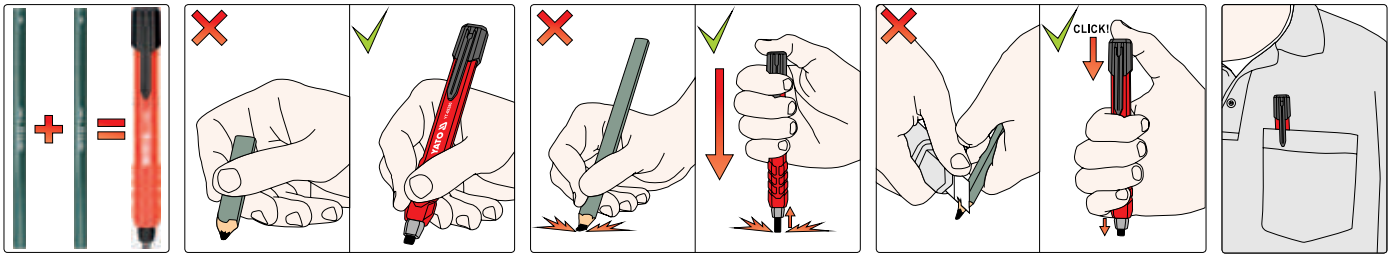



GB Automatic carpenters/masonry pencil  
D Tischler- und Maurer-Druckstift  
PL Ołówek stolarski/murarski automatyczny  
RUS Автоматический столярный карандаш/карандаш каменщика  
CZ Stolařská/zednická tužka automatická  
H Asztalos/kőműves töltőceruza

RO Creion de tâmplărie/zidărie mecanic  
F Crayon menuisier/maçon automatique  
I Matita per falegnami e carpentieri  
E Lápiz automático de carpintero/albanil  
CN 自动木工铅笔

**HB**



|   |   |
|---|---|
| <b>YATO</b>  |  |
| YT-69280  | 50/1000   |

GB Automatic carpenters/masonry pencil with spare leads  
D Tischler- und Maurer-Druckstift + zusätzliche Bleistiftmine  
PL Ołówek stolarski/murarski automatyczny + dodatkowe grafity  
RUS Автоматический столярный карандаш/карандаш каменщика + дополнительный графит  
CZ Stolařská/zednická tužka automatická + náhradní tuha

H Asztalos/kőműves töltőceruza + tartalék grafit  
RO Creion de tâmplărie/zidărie mecanic + grafit adițional  
F Crayon menuisier/maçon automatique  
I Matita per falegnami e carpentieri ricaricabile  
E Lápiz automático de carpintero/albanil + mina adicional  
CN 自动木工铅笔组套

**1+5 LEADS WKŁADY** **HB**

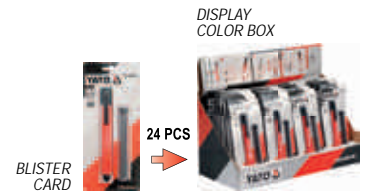



|   |   |
|---|---|
| <b>YATO</b>  |  |
| YT-69281  | 144   |

GB Lead HB  
D Bleistiftmine HB  
PL Grafit HB  
RUS Графит HB  
CZ Tuha HB  
H Grafit HB  
RO Grafit HB  
F Mine HB  
I Grafite HB  
E Mina HB  
CN 自动木工铅笔笔芯



for / dla: YT-69280, YT-69281

|   |   |
|---|---|
| <b>YATO</b>  |  |
| YT-69285  | 20/1000   |

GB Lead H2  
D Bleistiftmine H2  
PL Grafit H2  
RUS Графит H2  
CZ Tuha H2  
H Grafit H2  
RO Grafit H2  
F Mine H2  
I Grafite H2  
E Mina H2  
CN 自动木工铅笔笔芯



for / dla: YT-69280, YT-69281

|   |   |
|---|---|
| <b>YATO</b>  |  |
| YT-69286  | 20/1000   |

GB Lead HB  
D Bleistiftmine HB  
PL Grafit HB  
RUS Графит HB  
CZ Tuha HB  
H Grafit HB  
RO Grafit HB  
F Mine HB  
I Grafite HB  
E Mina HB  
CN 自动木工铅笔笔芯



for / dla: YT-69280, YT-69281

|   |   |
|---|---|
| <b>YATO</b>  |  |
| YT-69287  | 20/1000   |

# 14

## Measuring tools Narzędzia miernicze





Electric meters  
Mierniki elektryczne

266



Vernier calipers  
Suwmiarki

270



Multimeters  
Mierniki

267



Micrometers  
Mikrometry

271



Measuring tapes  
Miary zwijane

268-269



Electronic measuring tools  
Elektroniczne urządzenia pomiarowe

272



Rulers  
Przymiary

270



Levels  
Poziomnice

273



Try squares  
Kątowniki stolarskie

270



Feelers  
Szczelinomierze

273



GB Digital voltage tester  
 D Digitaler-Spannungsprüfer  
 PL Wskaźnik elektryczny  
 RUS Тестер напряжения цифровой  
 CZ Zkoušečka napětí digitální  
 H Digitális voltmérő  
 RO Tester digital pt. tensiune electrica

F Testeur de tension  
 type tournevis  
 I Cerca fase digitale  
 E Indicador eléctrico  
 CN 数显测电笔

SLIDING  
CARD



12-250  
V

50-500  
Hz

LCD  
DISPLAY

NO BATTERY  
NEEDED  
NE POTRZEBUJE  
BATERII



|             |        |
|-------------|--------|
| <b>YATO</b> |        |
| YT-2861     | 20/500 |



|             |        |
|-------------|--------|
| <b>YATO</b> |        |
| YT-2862     | 20/500 |



|             |       |
|-------------|-------|
| <b>YATO</b> |       |
| YT-2863     | 6/120 |

GB Analogue battery tester  
 D Analoges Batterieprüfgerät  
 PL Tester akumulatorów analogowy  
 RUS Аналоговый тестер аккумуляторов  
 CZ Analogový tester akumulátorů  
 H Analóg akkuteszter  
 RO Tester acumulatori analog  
 F Testeur de charge batterie  
 I Tester analogico per batteria  
 E Tester analógico para acumuladores  
 CN 电池测试器

6 V

12 V

CCA  
200-  
1000 A

GB Digital battery tester  
 D Digitales Batterieprüfgerät  
 PL Tester akumulatorów cyfrowy  
 RUS Цифровой тестер аккумуляторов  
 CZ Digitální tester akumulátorů  
 H Digitális akkuteszter  
 RO Tester acumulatori digital  
 F Testeur digital de charge batterie  
 I Tester digitale per batteria  
 E Tester digital para acumuladores  
 CN 电池测试器

12 V

LED  
DISPLAY

CCA  
150-  
1400 A

GB Battery tester  
 D Batterieprüfgerät  
 PL Tester akumulatorów  
 RUS Тестер аккумуляторов  
 CZ Tester akumulátorů  
 H Akkuteszter  
 RO Tester acumulatori  
 F Testeur électronique de charge  
 batterie et alternateur  
 I Tester per batteria  
 E Tester para acumuladores  
 CN 电池测试器

12 V

BATTERY  
TEST  
TEST  
AKUMULATORA  
ALTERNATOR  
TEST  
TEST  
ALTERNATORA

14



COLOR  
BOX

|             |    |
|-------------|----|
| <b>YATO</b> |    |
| YT-8310     | 10 |



COLOR  
BOX

|             |    |
|-------------|----|
| <b>YATO</b> |    |
| YT-8311     | 10 |



DOUBLE  
BLISTER

|             |       |
|-------------|-------|
| <b>YATO</b> |       |
| YT-83101    | 12/72 |



GB Digital universal multimeter  
D Universell digital Messgerät  
PL Cyfrowy miernik uniwersalny  
RUS Универсальный цифровой измеритель  
CZ Digitální multimetr univerzální  
H Digitális multiméter  
RO Multimetru digital universal  
F Multimètre numérique  
I Universale tester digitale  
E Manómetro digital universal  
CN 数字万用表

|                  |                   |                         |
|------------------|-------------------|-------------------------|
| U<br>0-500<br>~V | U<br>0-500<br>~V  | I<br>0-5<br>~A          |
| R<br>0-2<br>MΩ   |                   | h <sub>FE</sub> PNP NPN |
|                  | 5V <sub>P-P</sub> |                         |



**YATO**  
YT-73080 50

|                   |                         |                 |                 |                 |                 |
|-------------------|-------------------------|-----------------|-----------------|-----------------|-----------------|
| U<br>0-1000<br>~V | U<br>0-750<br>~V        | I<br>0-10<br>~A | I<br>0-10<br>~A | R<br>0-20<br>MΩ | C<br>0-20<br>μF |
|                   | h <sub>FE</sub> PNP NPN | AUTO POWER OFF  |                 |                 |                 |



**YATO**  
YT-73082 30

|                      |                  |                         |                           |                 |                   |
|----------------------|------------------|-------------------------|---------------------------|-----------------|-------------------|
| U<br>0-600<br>~V     | U<br>0-600<br>~V | I<br>0-10<br>~A         | I<br>0-10<br>~A           | R<br>0-20<br>MΩ | C<br>0-1000<br>μF |
| T<br>-20°<br>+1000°C |                  | h <sub>FE</sub> PNP NPN | AUTO RANGE<br>AUTO ZAKRES | AUTO POWER OFF  |                   |



**YATO**  
YT-73084 44

|                  |                  |                  |                      |                 |                           |
|------------------|------------------|------------------|----------------------|-----------------|---------------------------|
|                  | U<br>0-600<br>~V | U<br>0-600<br>~V | I<br>0-10<br>~A      | I<br>0-10<br>~A | R<br>0-40<br>MΩ           |
| C<br>0-100<br>μF | f<br>100<br>kHz  |                  | T<br>-20°<br>+1000°C |                 | AUTO RANGE<br>AUTO ZAKRES |
|                  |                  | 5%+95%           |                      |                 |                           |
|                  |                  |                  |                      | AUTO POWER OFF  |                           |



**YATO**  
YT-73086 24

|                  |                  |                           |                      |                 |                    |
|------------------|------------------|---------------------------|----------------------|-----------------|--------------------|
| 5 in 1<br>5 w 1  | U<br>0-600<br>~V | U<br>0-600<br>~V          | I<br>0-10<br>~A      | I<br>0-10<br>~A | R<br>0-40<br>MΩ    |
| C<br>0-100<br>μF | f<br>200<br>kHz  |                           | T<br>-20°<br>+1000°C |                 | %RH<br>30%+<br>90% |
|                  |                  | 1%+99%                    |                      |                 |                    |
|                  |                  | AUTO RANGE<br>AUTO ZAKRES | AUTO POWER OFF       |                 |                    |
| 3.5-100dB        | 40000 lx         |                           |                      |                 |                    |



**YATO**  
YT-73087 24

|                   |                   |                  |                      |                 |                           |
|-------------------|-------------------|------------------|----------------------|-----------------|---------------------------|
| TRUE RMS          | U<br>0-600<br>~V  | U<br>0-600<br>~V | I<br>0-10<br>~A      | I<br>0-10<br>~A | R<br>0-60<br>MΩ           |
| C<br>0-4000<br>μF | f<br>9.999<br>MHz |                  | T<br>-20°<br>+1000°C |                 | AUTO RANGE<br>AUTO ZAKRES |
|                   |                   | 5%+95%           |                      |                 |                           |
|                   |                   |                  |                      | AUTO POWER OFF  |                           |
|                   |                   |                  |                      |                 | USB                       |



**YATO**  
YT-73088 20



|                      |                  |                           |                  |
|----------------------|------------------|---------------------------|------------------|
| U<br>0-600<br>~V     | U<br>0-600<br>~V | I<br>0-600<br>~A          | R<br>0-200<br>MΩ |
| T<br>-20°<br>+1000°C |                  | AUTO RANGE<br>AUTO ZAKRES | AUTO POWER OFF   |
|                      |                  |                           |                  |
|                      |                  |                           |                  |



**YATO**  
YT-73091 20



GB Measuring tape CZ Měřicí pásmo F Ruban à mesurer E Flexómetro  
 D Rollbandmass H Mérőszalag I Misura di nastro CN 卷尺  
 PL Miara zwijana RO Rulete din pinza  
 RUС Рулетка



**3m**  
16mm

**5m**  
19mm



**AUTOMATIC**  

**GRADE II**  

**MAGNETIC HOOK**  

**NYLON COATED**  

**SLIDING CARD**  

| YATO  | L (m) | size / rozmiar (mm) |  |
|--|-------|---------------------|---|
| YT-7103  | 3     | 16                  | 12/120  |
| YT-7105  | 5     | 19                  | 12/120  |



**3m**  
16mm

**5m**  
25mm

**8m**  
25mm



**AUTOMATIC**  

**GRADE II**  

**MAGNETIC HOOK**  

**NYLON COATED**  

**DOUBLE BLISTER**  

| YATO  | L (m) | size / rozmiar (mm) |  |
|--|-------|---------------------|---|
| YT-7110  | 3     | 16                  | 12/120  |
| YT-7111  | 5     | 25                  | 12/120  |
| YT-7112  | 8     | 25                  | 6/60  |



**3m**  
16mm

**5m**  
19mm



**8m**  
25mm

**GRADE II**  

**MAGNETIC HOOK**  

**NYLON COATED**  

**DOUBLE BLISTER**  

| YATO  | L (m) | size / rozmiar (mm) |  |
|--|-------|---------------------|---|
| YT-7116  | 3     | 16                  | 12/120  |
| YT-7117  | 5     | 19                  | 12/120  |
| YT-7118  | 8     | 25                  | 6/60  |



**3m**  
16mm

**5m**  
19mm



**8m**  
25mm

**GRADE II**  

**MAGNETIC HOOK**  

**NYLON COATED**  

**DOUBLE BLISTER**  

| YATO  | L (m) | size / rozmiar (mm) |  |
|--|-------|---------------------|---|
| YT-7126  | 3     | 16                  | 12/120  |
| YT-7127  | 5     | 19                  | 12/120  |
| YT-7128  | 8     | 25                  | 6/60  |



**3m**  
16mm

**5m**  
19mm



**8m**  
25mm

**GRADE II**  

**MAGNETIC HOOK**  

**NYLON COATED**  

**DOUBLE BLISTER**  

| YATO  | L (m) | size / rozmiar (mm) |  |
|--|-------|---------------------|---|
| YT-7129  | 3     | 16                  | 12/120  |
| YT-7130  | 5     | 19                  | 12/120  |
| YT-7131  | 8     | 25                  | 6/60  |





**3m**  
16mm

**5m**  
19mm

**8m**  
25mm

**GRADE II**  

**DISPLAY BOX**  

| YATO  | L (m) | size / rozmiar (mm) | PCS packing |  |
|--|-------|---------------------|-------------|---|
| YT-71130   | 3     | 16                  | 12          | 60/120  |
| YT-71131   | 5     | 19                  | 12          | 48/96   |
| YT-71133   | 8     | 25                  | 12          | 18/36   |





**3m**  
16mm

**5m**  
19mm

**8m**  
25mm

**GRADE II**  

**DOUBLE BLISTER**  

| YATO  | L (m) | size / rozmiar (mm) |  |
|--|-------|---------------------|---|
| YT-71135   | 3     | 16                  | 12/144  |
| YT-71136   | 5     | 19                  | 12/72   |
| YT-71138   | 8     | 25                  | 8/48  |



**3m**  
16mm

**5m**  
19mm

**7.5m**  
25mm

**10m**  
25mm

**10ft**  
5/8"



**16ft**  
3/4"

**25ft**  
1"

**33ft**  
1"

**GRADE II**  

**DOUBLE BLISTER**  

| YATO  | L             | size / rozmiar |  |
|--|---------------|----------------|---|
| YT-71141   | 3 m / 10 ft   | 16 mm / 5/8"   | 12/144  |
| YT-71143   | 5 m / 16 ft   | 19 mm / 3/4"   | 12/96   |
| YT-71145   | 7.5 m / 25 ft | 25 mm / 1"     | 12/48   |
| YT-71146   | 10 m / 33 ft  | 25 mm / 1"     | 12/36   |



GB Measuring tape CZ Měřicí pásmo F Ruban à mesurer E Flexómetro  
D Rollbandmass H Mérőszalag I Misura di nastro CN 卷尺  
PL Miara zwijana RO Ruleta din pinza  
RUS Рулетка

3m  
16mm

5m  
19mm

8m  
25mm

GRADE  
II

NYLON  
COATED



DISPLAY  
BOX

2m  
16mm

3m  
16mm

5m  
19mm

8m  
25mm

10m  
25mm

GRADE  
II

NYLON  
COATED



DOUBLE  
BLISTER

| YATO     | L (m) | size / rozmiar (mm) | PCS<br>packing |        |
|----------|-------|---------------------|----------------|--------|
| YT-71181 | 3     | 16                  | 12             | 60/120 |
| YT-71182 | 5     | 19                  | 12             | 36/72  |
| YT-71184 | 8     | 25                  | 12             | 24/48  |

| YATO     | L (m) | size / rozmiar (mm) |        |
|----------|-------|---------------------|--------|
| YT-71185 | 2     | 16                  | 12/144 |
| YT-71186 | 3     | 16                  | 12/120 |
| YT-71187 | 5     | 19                  | 12/72  |
| YT-71188 | 8     | 25                  | 6/36   |
| YT-71189 | 10    | 25                  | 6/36   |

GB Steel measuring tape F Ruban à mesurer acier  
D Rollbandmass I Misura di nastro a acciaio  
PL Taśma miernicza stalowa E Cinta de medir de acero  
RUS Мерная лента стальная CN 长钢卷尺  
CZ Měřicí pásmo ocelové  
H Acél mérőszalag  
RO Ruleta sticla

20m  
13mm

30m  
13mm

50m  
13mm

STEEL TAPE  
TAŚMA STALOWA

SPEEDY  
RETRACTING  
SZYBSZE  
ZWIJANIE

ABS



PAPER  
HANGER

| YATO     | L (m) | size / rozmiar (mm) |      |
|----------|-------|---------------------|------|
| YT-71560 | 20    | 13                  | 5/20 |
| YT-71561 | 30    | 13                  | 5/20 |
| YT-71562 | 50    | 13                  | 5/20 |

GB Fibreglass measuring tape F Ruban à mesurer  
D Rollbandmass I Misura di nastro  
PL Taśma miernicza z włókna szklanego  
RUS Мерная лента фибергласс E Cinta de medir - fibra cristal  
CZ Měřicí pásmo - skleněné vlákno  
H Mérőszalag - üvegszál  
RO Ruleta fibra sticla

20m  
15mm

30m  
15mm

50m  
13mm

FIBREGLASS TAPE  
TAŚMA Z WŁÓKNA  
SZKLANEGO

SPEEDY  
RETRACTING  
SZYBSZE  
ZWIJANIE

ABS



PAPER  
HANGER

| YATO     | L (m) | size / rozmiar (mm) |      |
|----------|-------|---------------------|------|
| YT-71565 | 20    | 15                  | 5/20 |
| YT-71566 | 30    | 15                  | 5/20 |
| YT-71567 | 50    | 15                  | 5/20 |

GB Steel survey tape RO Bandă de măsură pt. geodezie  
D Rollbandmass F Ruban à mesurer acier  
PL Miara geodezyjna stalowa I Nastro flessibile  
RUS Мерная лента стальная E Cinta de medir de acero  
CZ Měřicí pásmo ocelové geodetické CN 手提架式钢卷尺  
H Acél mérőszalag, geodéziai

30m  
13mm

50m  
13mm

STEEL TAPE  
TAŚMA STALOWA

ABS



COLOR BOX

| YATO     | L (m) | size / rozmiar (mm) |    |
|----------|-------|---------------------|----|
| YT-71551 | 30    | 13                  | 10 |
| YT-71552 | 50    | 13                  | 10 |

GB Fibreglass survey tape H Mérőszalag - üvegszál  
D Rollbandmass RO Ruleta fibra sticla  
PL Miara geodezyjna F Ruban à mesurer acier  
CZ Měřicí pásmo - skleněné vlákno I Misura di nastro in fibra di vetro  
RUS Мерная лента фибергласс E Cinta de medir - fibra cristal  
CN 手提架式纤维卷尺

30m  
13mm

50m  
13mm

FIBREGLASS TAPE  
TAŚMA Z WŁÓKNA  
SZKLANEGO

ABS



COLOR BOX

| YATO     | L (m) | size / rozmiar (mm) |    |
|----------|-------|---------------------|----|
| YT-71555 | 30    | 13                  | 10 |
| YT-71556 | 50    | 13                  | 10 |

- GB Aluminium ruler      *RUS* Линейка алюминиевая      *RO* Riglă tâmplar din aluminiu      *E* Regla de aluminiu  
*D* Alu zeichen-massstab      *CZ* Měřicí lat' hliníková      *F* Règle aluminium      *CN* 铝合金直尺  
*PL* Przymiar aluminiowy      *H* Aszталos vonalzó, alumínium      *I* Righello di alluminio

AI



| YATO    | L (mm) |        |
|---------|--------|--------|
| YT-7070 | 300    | 25/100 |
| YT-7071 | 600    | 10/50  |

- GB Aluminium try square  
*D* Anschlagwinkel  
*PL* Kałownik aluminiowy  
*RUS* Угольник столярный  
*CZ* Truhlářský úhelník  
*H* Aszталos derékszög  
*RO* Echer de tâmplărie  
*F* Equerre en aluminium  
*I* Angolo di alluminio  
*E* Escuadra de aluminio  
*CN* 铝合金角尺

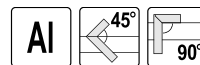

| YATO    | L (mm) |      |
|---------|--------|------|
| YT-7080 | 250    | 6/36 |
| YT-7081 | 300    | 6/36 |
| YT-7082 | 350    | 6/36 |

- GB Try square  
*D* Anschlagwinkel  
*PL* Kałownik stalowy  
*RUS* Угольник столярный  
*CZ* Truhlářský úhelník  
*H* Aszталos derékszög  
*RO* Echer de tâmplărie  
*F* Equerre  
*I* Angolo di acciaio  
*E* Escuadra  
*CN* 不锈钢角尺



STAINLESS  
STEEL  
STAL  
NERDZEWA



| YATO    | size / rozmiar (mm) |        |
|---------|---------------------|--------|
| YT-7083 | 150 x 300           | 25/100 |
| YT-7084 | 250 x 500           | 10/50  |

- GB Vernier caliper  
*D* Messschieber  
*PL* Suwmiarka  
*RUS* Штангенциркуль  
*CZ* Posuvné měřtko  
*H* Tolómérő  
*RO* Şubler  
*F* Pied à coulisse  
*I* Calibro  
*E* Calibre  
*CN* 游标卡尺

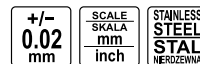

| YATO    | range / zakres (mm) |       |
|---------|---------------------|-------|
| YT-7200 | 0-150               | 10/50 |

- GB Digital caliper  
*D* Digital Messschieber  
*PL* Suwmiarka elektroniczna  
*RUS* Штангенциркуль электронный  
*CZ* Posuvné měřtko elektronické  
*H* Elektronikus tolómérő  
*RO* Şubler electronic  
*F* Pied à coulisse électronique  
*I* Calibro  
*E* Calibre electrónico  
*CN* 数显卡尺

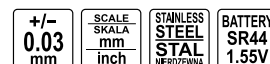

| YATO    | range / zakres (mm) |       |
|---------|---------------------|-------|
| YT-7201 | 0-150               | 10/50 |

- GB Vernier caliper  
*D* Messschieber  
*PL* Suwmiarka  
*RUS* Штангенциркуль  
*CZ* Posuvné měřtko  
*H* Tolómérő  
*RO* Şubler  
*F* Pied à coulisse  
*I* Calibro  
*E* Calibre  
*CN* 游标卡尺

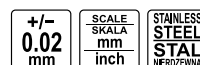

| YATO     | range / zakres (mm) |    |
|----------|---------------------|----|
| YT-72003 | 0-200               | 30 |
| YT-72004 | 0-300               | 20 |





- GB Micrometer
- D Mikrometer
- PL Mikrometr
- RUS Микрометр
- CZ Mikrometr
- H Mikrométer
- RO Micrometru
- F Micromètre
- I Micrometro
- E Micrómetro
- CN 外径千分尺

+/-  
**0.01**  
mm



PLASTIC CASE  
& COLOR BOX

| YATO  | range / zakres (mm) |  |
|--|---------------------|---|
| YT-72300   | 0-25                | 30  |
| YT-72301   | 25-50               | 30  |
| YT-72302   | 50-75               | 20  |
| YT-72303   | 75-100              | 10  |

- GB Micrometer with a digital display
- D Mikrometer mit Digitalanzeige
- PL Mikrometr z wyświetlaczem cyfrowym
- RUS Микрометр с цифровым индикатором
- CZ Mikrometr s digitálním displejem
- H Mikrométer digitális kijelzővel
- RO Micrometru cu afişaj digital
- F Micromètre
- I Micrometro con digitale elettronico
- E Micrómetro con pantalla digital
- CN 数显千分尺

+/-  
**0.01**  
mm

SCALE  
SKALA  
mm  
inch

**LCD**  
DISPLAY



PLASTIC CASE  
& COLOR BOX

| YATO  | range / zakres (mm) |  |
|--|---------------------|---|
| YT-72305   | 0-25                | 20  |

GB Laser distance meter  
 D Laserentfernungsmesser  
 PL Dalmierz laserowy  
 RUS Лазерный дальномер  
 CZ Laserový měřič vzdálenosti  
 H Lézeres távolságmérő  
 RO Telemetru cu laser  
 F Télémètre laser  
 I Telemetro laser  
 E Medidores láser de distancias  
 CN 激光测距仪

COLOR BOX



0.05-30 m  
 +/- 2 mm



20 MEMORY PAMIEĆ

7 MODES TRYBÓW

GB Laser distance meter  
 D Laserentfernungsmesser  
 PL Dalmierz laserowy  
 RUS Лазерный дальномер  
 CZ Laserový měřič vzdálenosti  
 H Lézeres távolságmérő  
 RO Telemetru cu laser  
 F Télémètre laser  
 I Telemetro laser  
 E Medidores láser de distancias  
 CN 激光测距仪

COLOR BOX



0.05-40 m  
 +/- 2 mm



20 MEMORY PAMIEĆ

8 MODES TRYBÓW

GB Stud finder  
 D Entfernungsmesser  
 PL Wykrywacz profili i przewodów  
 RUS Цифровой детектор  
 CZ Digitální detektor  
 H Digitális kereső műszer  
 RO Detector digital  
 F Détecteur de métaux et de câbles électriques  
 I Detector digitale  
 E Escáner de pared  
 CN 墙体探测仪

HANGING COLOR BOX



max.100 mm

CALIBRATION AUTO KALIBRACJA

ZOOM



14

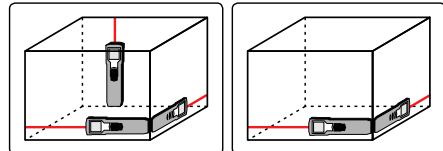
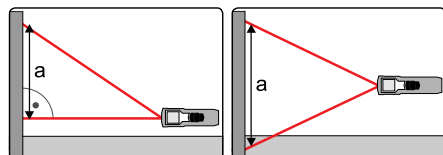

YATO YT-73124 40

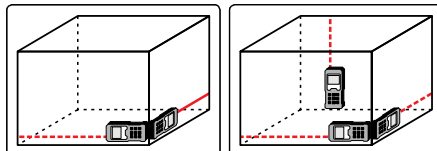
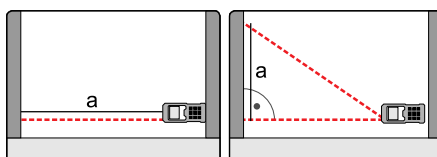

YATO YT-73125 20

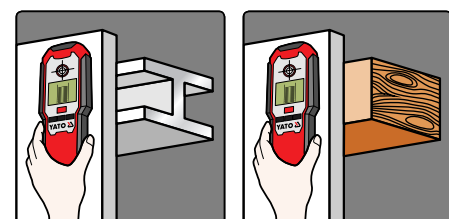
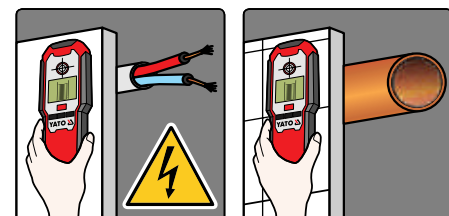

YATO YT-73130 20



GB Aluminium level  
D Wasserwaage  
PL Poziomnica aluminiowa  
RUS Уровень

CZ Vodováha  
H Vizmérték  
RO Cumpănă  
F Niveau à bulle

I Livella  
E Nivel  
CN 铝合金水平尺



SHOCK PROOF  
GDPORNA  
NA WSTRZASY

1.5mm  
ALUMINIUM  
HIGH QUALITY PROFILE  
ALUMINIOWY  
PROFIL WYSOKIEJ JAKOŚCI

ACCURACY  
DOKŁADNOŚĆ  
0.057°  
= 1.0 mm/m

3  
PRECISION  
VIALS  
LIBELKI

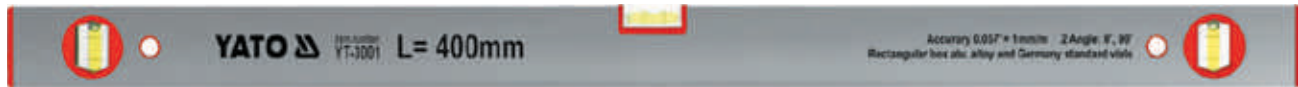

| YATO    | L (mm) |       |
|---------|--------|-------|
| YT-3001 | 400    | 20/60 |
| YT-3002 | 600    | 20/60 |
| YT-3003 | 800    | 20/60 |
| YT-3004 | 1000   | 20/60 |
| YT-3005 | 1200   | 20/60 |



| YATO    | L (mm) |       |
|---------|--------|-------|
| YT-3022 | 600    | 20/60 |
| YT-3023 | 800    | 20/60 |
| YT-3024 | 1000   | 30    |
| YT-3025 | 1200   | 30    |
| YT-3026 | 1500   | 30    |

GB Feeler  
D Fühlerlehre  
PL Szczelinomierz  
RUS Щупы  
CZ Spároměr  
H Hézagmérő

RO Lere  
F Palpeur  
I Spessimetro  
E Calibre de fisuras  
CN 塞尺

DOUBLE  
BLISTER



100 mm  
10 mm  
17 GAUGES LISTKÓW  
TAPER ZBIEŻNY

200 mm  
12.8 mm  
17 GAUGES LISTKÓW  
PARALLEL RÓWNOLEGŁY

| YATO    | L (mm) | width / szerokość | size / rozmiar   |        |
|---------|--------|-------------------|--|--------|
| YT-7220 | 100    | 10                | 0.02, 0.03, 0.04, 0.05, 0.06, 0.07, 0.08, 0.09, 0.10, 0.15, 0.20, 0.25, 0.30, 0.40, 0.50, 0.75, 1.00 | 10/200 |

| YATO    | L (mm) | width / szerokość | size / rozmiar   |        |
|---------|--------|-------------------|--|--------|
| YT-7221 | 200    | 12.8              | 0.02, 0.03, 0.04, 0.05, 0.06, 0.07, 0.08, 0.09, 0.10, 0.15, 0.20, 0.25, 0.30, 0.40, 0.50, 0.75, 1.00 | 10/100 |



100 mm  
10 mm  
10 GAUGES LISTKÓW  
TAPER ZBIEŻNY

200 mm  
12.8 mm  
14 GAUGES LISTKÓW  
PARALLEL RÓWNOLEGŁY

| YATO    | L (mm) | width / szerokość | size / rozmiar   |        |
|---------|--------|-------------------|--|--------|
| YT-7222 | 100    | 10                | 0.05, 0.06, 0.07, 0.08, 0.09, 0.10, 0.20, 0.30, 0.40, 0.50 | 10/100 |

| YATO    | L (mm) | width / szerokość | size / rozmiar   |        |
|---------|--------|-------------------|--|--------|
| YT-7223 | 200    | 12.8              | 0.05, 0.06, 0.07, 0.08, 0.09, 0.10, 0.15, 0.20, 0.25, 0.30, 0.35, 0.40, 0.45, 0.50 | 10/100 |

# 15

## Pneumatic tools Narzędzia pneumatyczne





**Impact wrenches**  
Klucze udarowe

276-278



**Pneumatic accessories**  
Akcesoria instalacji pneumatycznej

284-285



**Impact wrenches 3/8"**

Klucze udarowe 3/8".....

276

**Impact wrenches 1/2"**

Klucze udarowe 1/2".....

276

**Impact wrenches 3/4"**

Klucze udarowe 3/4".....

277

**Impact wrenches 1"**

Klucze udarowe 1".....

278

**Air filters, regulators & lubricators**

Filtry, reduktory i smarownice.....

284

**Couplers**

Złącza.....

285

**Other air tools**

Inne narzędzia pneumatyczne

279-282



**Pneumatic riveters**

Nitownice pneumatyczne

286



**Pneumatic ratchets & sets**

Grzechotki pneumatyczne i zestawy.....

279

**Pneumatic grinders & accessories**

Szlifierki pneumatyczne i akcesoria.....

279

**Pneumatic cut-off tools & discs**

Przecinarki pneumatyczne i tarcze.....

281

**Pneumatic drills**

Wiertarki pneumatyczne.....

281

**Pneumatic hammers**

Młotki pneumatyczne.....

281

**Tire inflating guns & heads**

Pistolety do pompowania kół i głowice.....

282

**Pneumatic stitching & nailing machines**

Zszywacze i gwoździarki pneumatyczne

287



**Pneumatic staplers**

Zszywacze pneumatyczne.....

287

**Pneumatic nailers**

Gwoździarki pneumatyczne.....

287

**Painting equipment**

Narzędzia do malowania

282-283



**Mini palm nailers**

Młotki pneumatyczne do gwoździ

287



**Spray guns**

Pistolety lakiernicze.....

282

**Inflating guns**

Pistolety do przedmuchiwania.....

283

**Washing guns**

Pistolety do ropowania.....

283

**Air sand blasters**

Pistolety do piaskowania.....

283

GB Impact wrench  
 D Druckluft-Schlagschrauber  
 PL Klucz pneumatyczny  
 RUS Ударный пневматический гайковерт  
 CZ Klíč pneumatický  
 H Pneumatikus ütvecsavarozó

RO Pistol pneumatic  
 F Clé à choc pneumatique  
 I Chiave ad impulsi pneumatica  
 E Llave neumática de percusión  
 CN 气动扳手

|                      |   |
|----------------------|---|
| <b>3/8"</b><br>10mm  | <b>TWIN HAMMER</b><br>TYPE  |
| <b>0.63 MPa</b>      | <b>142 l/min</b>  |
| <b>400 Nm</b>        | <b>10000 min<sup>-1</sup></b>   |
| <b>1/4"</b><br>6.3mm |  |



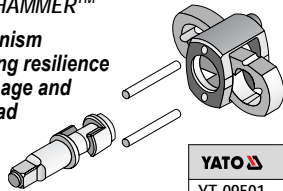

**TWIN HAMMER™**  
 mechanism  
 ensuring resilience  
 to damage and  
 overload



COLOR BOX



| YATO  | Nm  |  |
|--|-----|---|
| YT-09501   | 400 | 10  |

GB Impact wrench  
 D Druckluft-Schlagschrauber  
 PL Klucz pneumatyczny  
 RUS Ударный пневматический гайковерт  
 CZ Klíč pneumatický  
 H Pneumatikus ütvecsavarozó

RO Pistol pneumatic  
 F Clé à choc pneumatique  
 I Chiave ad impulsi pneumatica  
 E Llave neumática de percusión  
 CN 气动扳手

|                       |   |
|-----------------------|---|
| <b>1/2"</b><br>12.5mm | <b>TWIN HAMMER</b><br>TYPE  |
| <b>0.62 MPa</b>       | <b>105 l/min</b>  |
| <b>540 Nm</b>         | <b>7000 min<sup>-1</sup></b>  |
| <b>1/4"</b><br>6.3mm  |  |





COLOR BOX

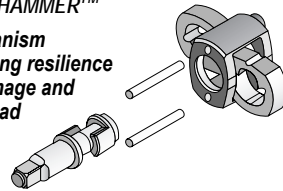

**TWIN HAMMER™**  
 mechanism  
 ensuring resilience  
 to damage and  
 overload



| YATO  | Nm  |  |
|--|-----|---|
| YT-0952  | 540 | 8   |

GB Impact wrench  
 D Druckluft-Schlagschrauber  
 PL Klucz pneumatyczny  
 RUS Ударный пневматический гайковерт  
 CZ Klíč pneumatický  
 H Pneumatikus ütvecsavarozó

RO Pistol pneumatic  
 F Clé à choc pneumatique  
 I Chiave ad impulsi pneumatica  
 E Llave neumática de percusión  
 CN 气动扳手

|                       |   |
|-----------------------|---|
| <b>1/2"</b><br>12.5mm | <b>TWIN HAMMER</b><br>TYPE  |
| <b>0.63 MPa</b>       | <b>119 l/min</b>  |
| <b>550 Nm</b>         | <b>7500 min<sup>-1</sup></b>  |
| <b>1/4"</b><br>6.3mm  |  |



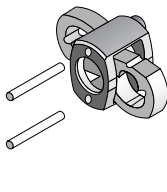

**TWIN HAMMER™**  
 mechanism  
 ensuring resilience  
 to damage and  
 overload



COLOR BOX



| YATO  | Nm  |  |
|--|-----|---|
| YT-09511   | 550 | 8   |

GB Impact wrench  
 D Druckluft-Schlagschrauber  
 PL Klucz pneumatyczny  
 RUS Ударный пневматический гайковерт  
 CZ Klíč pneumatický  
 H Pneumatikus ütvecsavarozó

RO Pistol pneumatic  
 F Clé à choc pneumatique  
 I Chiave ad impulsi pneumatica  
 E Llave neumática de percusión  
 CN 气动扳手

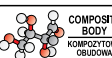
|                       |   |
|-----------------------|---|
| <b>1/2"</b><br>12.5mm | <b>TWIN HAMMER</b><br>TYPE  |
| <b>0.63 MPa</b>       | <b>142 l/min</b>  |
| <b>570 Nm</b>         | <b>10000 min<sup>-1</sup></b>   |
| <b>1/4"</b><br>6.3mm  |  |





COLOR BOX

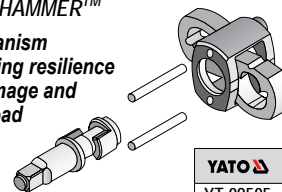

**TWIN HAMMER™**  
 mechanism  
 ensuring resilience  
 to damage and  
 overload



| YATO  | Nm  |  |
|--|-----|---|
| YT-09505   | 570 | 10  |



GB Impact wrench  
D Druckluft-Schlagschrauber  
PL Klucz pneumatyczny  
RUS Ударный пневматический гайковерт  
CZ Klíč pneumatický  
H Pneumatikus ütvecsavarozó

RO Pistol pneumatic  
F Clé à choc pneumatique  
I Chiave ad impulsi pneumatica  
E Llave neumática de percusión  
CN 气动扳手

**1/2"**  
**12.5mm**

**TWIN HAMMER TYPE**

**COMPOSITE BODY**  
KOMPOZITOWA OBLIOWNA

**0.63 MPa** **480 l/min**

**1356 Nm** **10000 min<sup>-1</sup>**

**1/4"**  
**6.3mm**



**TWIN HAMMER™**  
mechanism  
ensuring resilience  
to damage and  
overload

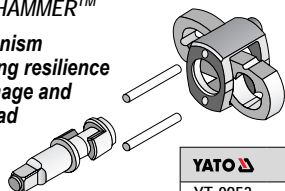

COLOR BOX



| YATO    | Nm   | Box |
|---------|------|-----|
| YT-0953 | 1356 | 10  |

GB Impact wrench  
D Druckluft-Schlagschrauber  
PL Klucz pneumatyczny  
RUS Ударный пневматический гайковерт  
CZ Klíč pneumatický  
H Pneumatikus ütvecsavarozó

RO Pistol pneumatic  
F Clé à choc pneumatique  
I Chiave ad impulsi pneumatica  
E Llave neumática de percusión  
CN 气动扳手

**1/2"**  
**12.5mm**

**TWIN HAMMER TYPE**

**COMPOSITE BODY**  
KOMPOZITOWA OBLIOWNA

**0.63 MPa** **153 l/min**

**1150 Nm** **10000 min<sup>-1</sup>**

**1/4"**  
**6.3mm**



**TWIN HAMMER™**  
mechanism  
ensuring resilience  
to damage and  
overload

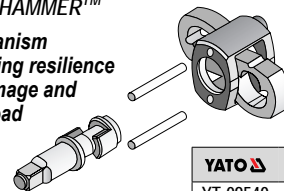

COLOR BOX



| YATO    | Nm   | Box |
|---------|------|-----|
| YT-0954 | 1150 | 10  |

GB Impact wrench  
D Druckluft-Schlagschrauber  
PL Klucz pneumatyczny  
RUS Ударный пневматический гайковерт  
CZ Klíč pneumatický  
H Pneumatikus ütvecsavarozó

RO Pistol pneumatic  
F Clé à choc pneumatique  
I Chiave ad impulsi pneumatica  
E Llave neumática de percusión  
CN 气动扳手

**3/4"**  
**19mm**

**DYNA PACT TYPE**

**0.62 MPa** **450 l/min**

**945 Nm** **4500 min<sup>-1</sup>**

**1/4"**  
**6.3mm**



**DYNA-PACT™**  
mechanism  
ensuring resilience  
to damage and  
overload



COLOR BOX



| YATO    | Nm  | Box |
|---------|-----|-----|
| YT-0956 | 945 | 4   |

GB Impact wrench  
D Druckluft-Schlagschrauber  
PL Klucz pneumatyczny  
RUS Ударный пневматический гайковерт  
CZ Klíč pneumatický  
H Pneumatikus ütvecsavarozó

RO Pistol pneumatic  
F Clé à choc pneumatique  
I Chiave ad impulsi pneumatica  
E Llave neumática de percusión  
CN 气动扳手

**3/4"**  
**19mm**

**TWIN HAMMER TYPE**

**COMPOSITE BODY**  
KOMPOZITOWA OBLIOWNA

**0.63 MPa** **198 l/min**

**1630 Nm** **5500 min<sup>-1</sup>**

**3/8"**  
**10mm**



**TWIN HAMMER™**  
mechanism  
ensuring resilience  
to damage and  
overload

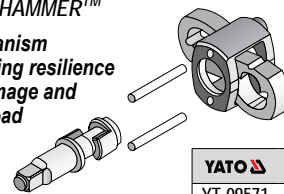

COLOR BOX



| YATO     | Nm   | Box |
|----------|------|-----|
| YT-09571 | 1630 | 6   |



GB Pneumatic wrench  
D Druckluft-Schlüssel  
PL Klucz pneumatyczny  
RUS Пневматический ключ  
CZ Pneumatický utahovák  
H Pneumatikus kulcs

RO Cheie pneumatica  
F Clé à choc pneumatique  
I Chiave ad impulsi pneumatica  
E Llave neumática  
CN 气动扳手

**PINLESS HAMMER™**

**closed hammer cage mechanism prevents breakage from hammer pin damage**

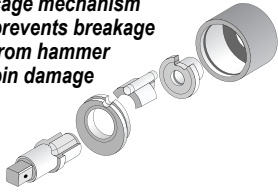

- application: automotive service stations, trucks
- przeznaczenie: serwis, samochody ciężarowe
- strong, uniform impact
- silny, jednolity uder



|            |                        |                |           |
|------------|------------------------|----------------|-----------|
| 1"<br>25mm | PINLESS HAMMER TYPE    | 0.63 MPa       | 560 l/min |
| 2600 Nm    | 4000 min <sup>-1</sup> | 1/2"<br>12.5mm |           |

BMC & COLOR SLEEVE



|             |      |   |
|-------------|------|---|
| <b>YATO</b> | Nm   |   |
| YT-0959     | 2600 | 2 |

GB Pneumatic wrench  
D Druckluft-Schlüssel  
PL Klucz pneumatyczny  
RUS Пневматический ключ  
CZ Pneumatický utahovák  
H Pneumatikus kulcs

RO Cheie pneumatica  
F Clé à choc pneumatique  
I Chiave ad impulsi pneumatica  
E Llave neumática  
CN 气动扳手

**PINLESS HAMMER™**

**closed hammer cage mechanism prevents breakage from hammer pin damage**

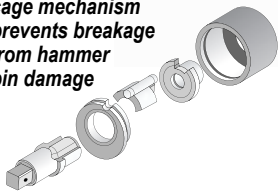

- application: automotive service stations, trucks
- przeznaczenie: serwis, samochody ciężarowe
- strong, uniform impact
- silny, jednolity uder



|            |                        |                |           |
|------------|------------------------|----------------|-----------|
| 1"<br>25mm | PINLESS HAMMER TYPE    | 0.63 MPa       | 560 l/min |
| 2600 Nm    | 4000 min <sup>-1</sup> | 1/2"<br>12.5mm |           |

BMC & COLOR SLEEVE



|             |      |   |
|-------------|------|---|
| <b>YATO</b> | Nm   |   |
| YT-0960     | 2600 | 2 |

GB Pneumatic wrench  
D Druckluft-Schlüssel  
PL Klucz pneumatyczny  
RUS Пневматический ключ  
CZ Pneumatický utahovák  
H Pneumatikus kulcs

RO Cheie pneumatica  
F Clé à choc pneumatique  
I Chiave ad impulsi pneumatica  
E Llave neumática  
CN 气动扳手

- application: industry, service stations, tire service stations, truck service
- the lightest 1" impact wrench with torque of 2700 Nm
- magnesium alloy and composite housing
- low vibration
- low air consumption
- przeznaczenie: przemysł, serwisy mobilne i stacjonarne, serwisy opon oraz pojazdów ciężarowych
- najlżejszy klucz pneumatyczny w klasie 1" o mocy 2700 Nm
- obudowa ze stopów magnezu i kompozytu
- niski poziom wibracji
- małe zużycie powietrza



|                   |                  |                        |           |
|-------------------|------------------|------------------------|-----------|
| 1"<br>25mm        | TWIN HAMMER TYPE | 0.63 MPa               | 255 l/min |
| 8.3kg ULTRA LIGHT | 2700 Nm          | 4800 min <sup>-1</sup> |           |

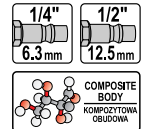

COMPOSITE BODY  
KOMPONENTOWA OBUWKA

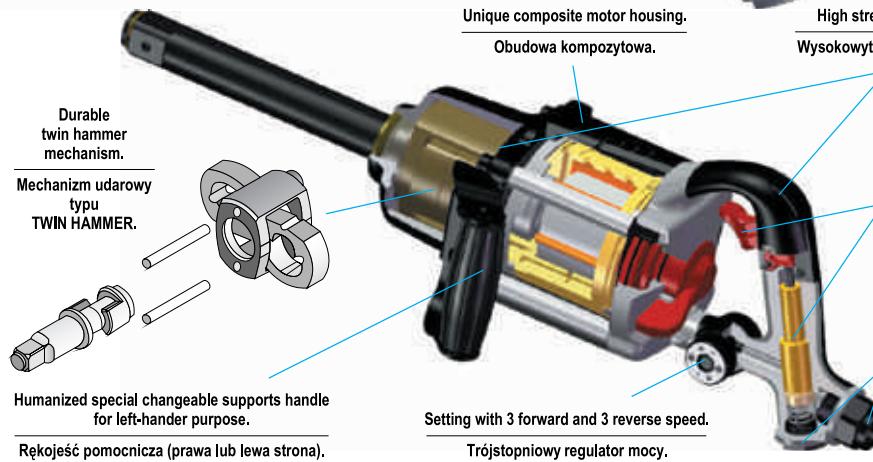

Durable twin hammer mechanism.

Mechanizm uderowy typu TWIN HAMMER.

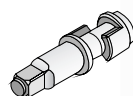

Humanized special changeable supports handle for left-handers purpose.

Rękojeść pomocnicza (prawa lub lewa strona).

Unique composite motor housing.

Obudowa kompozytowa.

High strength aluminum alloy.

Wysokowytrzymały stop aluminium.

Tigger with 2 speed control.

Włącznik z dwustopniową regulacją prędkości.

Two way changeable air inlet direction for comfort workplace.

Alternatywne gniazda przyłączeniowe.

Setting with 3 forward and 3 reverse speed.

Trójstopniowy regulator mocy.

COLOR BOX



|             |      |   |
|-------------|------|---|
| <b>YATO</b> | Nm   |   |
| YT-09611    | 2700 | 2 |



- GB Ratchet air wrench  
D Druckluft-Ratschenschrauber  
PL Grzechołka pneumatyczna  
RUS Пневмотрещотка  
CZ Utahovák vzduchový  
H Préslevegős behajtó szerszám  
RO Antrenor pneumatic  
F Clé à cliquet pneumatique  
I Chiave a cricchetto pneumatica  
E Carraca neumática  
CN 气动棘轮扳手



COLOR BOX



|                |                          |               |
|----------------|--------------------------|---------------|
| 1/2"<br>12.5mm | 0.62<br>MPa              | 120<br>l/min  |
| 80<br>Nm       | 160<br>min <sup>-1</sup> | 1/4"<br>6.3mm |

|             |    |    |
|-------------|----|----|
| <b>YATO</b> | Nm |    |
| YT-0981     | 80 | 20 |

- GB Ratchet air wrench  
D Druckluft-Ratschenschrauber  
PL Grzechołka pneumatyczna  
RUS Пневмотрещотка  
CZ Utahovák vzduchový  
H Préslevegős behajtó szerszám  
RO Antrenor pneumatic  
F Clé à cliquet pneumatique  
I Chiave a cricchetto pneumatica  
E Carraca neumática  
CN 气动棘轮扳手



COLOR BOX



|                |                          |               |
|----------------|--------------------------|---------------|
| 1/2"<br>12.5mm | 0.62<br>MPa              | 110<br>l/min  |
| 68<br>Nm       | 160<br>min <sup>-1</sup> | 1/4"<br>6.3mm |

|             |    |    |
|-------------|----|----|
| <b>YATO</b> | Nm |    |
| YT-0980     | 68 | 20 |

- GB Ratchet wrench kit  
D Druckluft-Ratschenschrauber mit Zubehör  
PL Zestaw z grzechołką pneumatyczną  
RUS Пневмотрещотка в наборе  
CZ Klíč ráčnový pneumatický s příslušenstvím  
H Pneumatikus racsnikulcs készlet  
RO Cheie pneumatica cu accesorii  
F Clé à cliquet pneumatique  
I Chiave a cricchetto pneumatica  
E Juego con carraca neumática  
CN 气动棘轮扳手组套



- 1/2" (12.7 mm), L=75 mm;
- 6 mm x 1/2" (12.7 mm);
- 1/2" (12.7 mm);
- H4, H5, H6, H7, H8;
- T20, T25, T27, T30, T40;
- 5.5, 6.5, 8.0 mm;
- PH2, PH3, PH4;
- 10, 11, 12, 13, 14, 17, 19 mm

|                |                          |
|----------------|--------------------------|
| 1/2"<br>12.5mm | OILER<br>POT             |
| 0.62<br>MPa    | 110<br>l/min             |
| 68<br>Nm       | 160<br>min <sup>-1</sup> |
| 1/4"<br>6.3mm  | CrV                      |

|             |    |   |
|-------------|----|---|
| <b>YATO</b> | Nm |   |
| YT-0982     | 68 | 4 |

BMC & COLOR SLEEVE



- GB Air grinder  
D Drucklufterhandschleifer  
PL Szlifierka pneumatyczna prosta  
RUS Шлифмашинка пневматическая  
CZ Bruska přímá pneumatická  
H Préslevegős sarokcsiszoló  
RO Polizor pneumatic  
F Mini ponceuse pneumatique  
I Smerigliatrice dritta pneumatica  
E Lijadora neumática recta  
CN 气动修磨机



COLOR BOX



|                           |               |
|---------------------------|---------------|
| 0.62<br>MPa               | 160<br>l/min  |
| 2000<br>min <sup>-1</sup> | 3 6mm         |
|                           | 1/4"<br>6.3mm |

|             |    |
|-------------|----|
| <b>YATO</b> |    |
| YT-0965     | 25 |

- GB Air sander  
D Druckluft-Excenterschleifer  
PL Szlifierka pneumatyczna mimośrodowa  
RUS Шлифмашинка эксцентриковая пневматическая  
CZ Bruska pneumatická  
H Pneumatikus sarokcsiszológép  
RO Masina de slefuit pneumatica  
F Ponceuse pneumatique  
I Smerigliatrice orbitale pneumatica  
E Lijadora neumática excéntrica  
CN 气动砂磨机



|                           |               |
|---------------------------|---------------|
| 0.62<br>MPa               | 230<br>l/min  |
| 9000<br>min <sup>-1</sup> | mm            |
|                           | 150           |
|                           | ECCENTRIC     |
|                           | 1/4"<br>6.3mm |

COLOR BOX

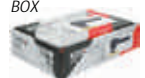

|             |    |
|-------------|----|
| <b>YATO</b> |    |
| YT-0967     | 10 |



GB Air sander  
 D Druckluft-Excenterschleifer  
 PL Szlifierka pneumatyczna oscylacyjna  
 RUS Шлифмашинка эксцентриковая пневматическая  
 CZ Bruska pneumatická  
 H Pneumatikus sarokcsiszológép  
 RO Masina de slefuit pneumatica  
 F Ponceuse triangulaire  
 I Levigatrice pneumatica oscillante  
 E Lijadora neumática excéntrica  
 CN 气动三角形砂磨机

0.62 MPa  
 71 l/min  
 10000 min<sup>-1</sup>  
 VACUUM SYSTEM SYSTEM ODPYLANIA  
 143x99 mm  
 1/4"  
 6.3 mm



**YATO**  
 YT-0976 10

GB Air sander  
 D Druckluft-Excenterschleifer  
 PL Szlifierka pneumatyczna oscylacyjna  
 RUS Шлифмашинка эксцентриковая пневматическая  
 CZ Bruska pneumatická  
 H Pneumatikus sarokcsiszológép  
 RO Masina de slefuit pneumatica  
 F Ponceuse rectangulaire  
 I Levigatrice pneumatica oscillante  
 E Lijadora neumática excéntrica  
 CN 气动三角形砂磨机

0.62 MPa  
 71 l/min  
 10000 min<sup>-1</sup>  
 VACUUM SYSTEM SYSTEM ODPYLANIA  
 130x80 mm  
 1/4"  
 6.3 mm



**YATO**  
 YT-0977 10

GB Air belt sander  
 D Pneumatische Bandschleifer  
 PL Pneumatyczna szlifierka taśmowa  
 RUS Пневматический шлифовальный  
 CZ Pneumatická pásová bruska  
 H Pneumatikus szalagcsiszoló  
 RO Polizor pneumatic cu banda  
 F Ponceuse à bandes pneumatique  
 I Nastro per levigatrice pneumatica  
 E Lijadora de banda neumática  
 CN 气动砂带机



0.63 MPa  
 20000 min<sup>-1</sup>  
 EASY BELT REPLACEMENT LATWA WYMIANA PASA  
 1/4"  
 6.3 mm



includes belts: / w zestawie pasy:  
 P60, P80, P120  
**YATO** belt size / rozmiar pasa (mm)  
 YT-09741 10x330 10

GB Air belt sander  
 D Pneumatische Bandschleifer  
 PL Pneumatyczna szlifierka taśmowa  
 RUS Пневматический шлифовальный  
 CZ Pneumatická pásová bruska  
 H Pneumatikus szalagcsiszoló  
 RO Polizor pneumatic cu banda  
 F Ponceuse à bandes pneumatique  
 I Nastro per levigatrice pneumatica  
 E Lijadora de banda neumática  
 CN 气动砂带机



0.63 MPa  
 20000 min<sup>-1</sup>  
 EASY BELT REPLACEMENT LATWA WYMIANA PASA  
 1/4"  
 6.3 mm



includes belts: / w zestawie pasy:  
 P60, P80, P120  
**YATO** belt size / rozmiar pasa (mm)  
 YT-09742 20x520 10

GB Endless sanding belt  
 D Schleifband  
 PL Taśma ścierna bezkońcowa  
 RUS Шлифовальные ленты

CZ Brusný pás  
 H Csiszoló szalag  
 RO Bandă de pânză

F Bande abrasive sans fin  
 I Nastro abrasivo senza fine

E Pano abrasivo cinturón  
 CN 砂带

TIED ON CARD



• application: metal, wood  
 • abrasive: aluminium oxide  
 • bond: synthetic resin  
 • coating: close

• zastosowanie: metal, drewno  
 • ścierniwo: tlenek glinu  
 • spoiwo: żywica syntetyczna  
 • nasyp pełny

• application: metal, wood  
 • abrasive: aluminium oxide  
 • bond: synthetic resin  
 • coating: close

• zastosowanie: metal, drewno  
 • ścierniwo: tlenek glinu  
 • spoiwo: żywica syntetyczna  
 • nasyp pełny

| YATO     | grit / ziarnistość | size / rozmiar (mm) | PCS packing |     |
|----------|--------------------|---------------------|-------------|-----|
| YT-09743 | 60                 | 10x330              | 10          | 100 |
| YT-09744 | 80                 | 10x330              | 10          | 100 |
| YT-09745 | 100                | 10x330              | 10          | 100 |
| YT-09746 | 120                | 10x330              | 10          | 100 |

| YATO     | grit / ziarnistość | size / rozmiar (mm) | PCS packing |    |
|----------|--------------------|---------------------|-------------|----|
| YT-09747 | 60                 | 20x520              | 10          | 50 |
| YT-09748 | 80                 | 20x520              | 10          | 50 |
| YT-09749 | 100                | 20x520              | 10          | 50 |
| YT-09750 | 120                | 20x520              | 10          | 50 |



GB Air cut-off tool  
D Druckluft-Schneidmaschine  
PL Przecinarka pneumatyczna  
RUS Резак пневматический  
CZ Příčná bruska pneumatická  
H Pneumatikus sarokcsiszoló

RO Masina de taiat  
cu aer comprimat  
F Coupeuse pneumatique  
I Fresa pneumática  
E Cortadora neumática  
CN 气动切割工具

0.62 MPa  
160 l/min  
18000 min<sup>-1</sup>  
1/4"  
6.3mm



COLOR BOX

**YATO**  
YT-0993 20

GB Metal cutting disc  
D Metall-Trennscheibe  
PL Tarcza do cięcia metalu  
RUS Круги отрезные по металлу  
CZ Souprava kotoučů pro řezání kovu  
H Vágókorong fémhez  
RO Set de pânze de tăiat metal  
F Set de disques  
I Disco per taglio metallo  
E Disco cortador para metal  
CN 金属切割片组套

for / dla: YT-0993

5 PCS  
75mm  
2mm  
9.5mm  
18000 min<sup>-1</sup>



BLISTER CARD

**YATO**  
YT-0994 12/48

GB Reversible air drill  
D Druckluft-Bohrmaschine mit Stahl-Zahnkranzfutter  
PL Wiertarka pneumatyczna  
RUS Пневматическая дрель  
CZ Vrtáčka ruční vzduchová  
H Préslevegős fúrógép  
RO Masina de gaurit pneumatica mandrina  
F Perceuse pneumatique  
I Fresa pneumática  
E Taladradora neumática  
CN 双向气钻



0.62 MPa  
180 l/min  
0-1800 min<sup>-1</sup>  
max. 10mm  
1/4"  
6.3mm

COLOR BOX

**YATO**  
YT-0970 20

GB Reversible air drill  
D Druckluft-Bohrmaschine mit Stahl-Zahnkranzfutter  
PL Wiertarka pneumatyczna  
RUS Пневматическая дрель  
CZ Vrtáčka ruční vzduchová  
H Préslevegős fúrógép

RO Masina de gaurit pneumatica mandrina  
F Perceuse pneumatique  
I Fresa pneumática  
E Taladradora neumática  
CN 双向气钻



1.7 kg  
0.63 MPa  
198 l/min  
700 min<sup>-1</sup>  
max. 10mm  
1/4"  
6.3mm

COLOR BOX

**YATO**  
YT-09702 12

GB Air hammer  
D Druckluft-Schlaghammer  
PL Młotek pneumatyczny  
RUS Зубило пневматическое  
CZ Sekáč vzduchový  
H Pneumatikus vésőkészlet pisztollyal  
RO Ciosam cu aer comprimat  
F Maretau pneumatique  
I Martello pneumática  
E Martillo neumático  
CN 气锤



0.62 MPa  
110 l/min  
3200 min<sup>-1</sup>  
1/4"  
6.3mm

COLOR BOX

**YATO**  
YT-0990 10

- GB Tire-inflating gun
- D Reifenfüller
- PL Pistolet do pompowania kół
- RUS Пистолет для накачивания колёс
- CZ Pistole na čerpání z manometrem
- H Gumiabroncs pumpáló
- RO Pistol cu manometru pt. pompat
- F Pistolet pour gonflage de pneus avec manomètre
- I Pistola per gonfiaggio gomme
- E Pistola de bombeo con manometro
- CN 轮胎气压表



|                |                |
|----------------|----------------|
| 1/4"           | 0.8 MPa (max.) |
| 6.3mm          |                |
| 440mm HOSE WAZ | AI             |



SLIDING CARD

|             |  |      |
|-------------|--|------|
| <b>YATO</b> |  |      |
| YT-2370     |  | 8/40 |

- GB Inflating head
- D Klemmnippel (universal)
- PL Glowica do pompowania
- RUS Универсальная головка
- CZ Hlava na čerpání
- H Pumpafej
- RO Cap pt. pompat
- F Mandrin de pompe
- I Testa per il pompaggio
- E Cabeza de bombeo
- CN 充气头



DOUBLE BLISTER

|                |
|----------------|
| 1.0 MPa (max.) |
|----------------|

|             |        |        |
|-------------|--------|--------|
| <b>YATO</b> | Ø (mm) |        |
| YT-2371     | 6      | 50/300 |
| YT-2372     | 8      | 50/300 |

- GB Spray gun with fluid cup
- D Lackierpistole mit Fließbecher
- PL Pistolet natryskowy
- RUS Пистолет - распылитель с верхним бачком

- CZ Pistole na lakování z nádrží
- H Festőpisztoly alsó tartállyal
- RO Pistol de vopsit cu rezervor inferior
- F Pistolet à peinture
- I Pistola vernice

- E Pistola de barniz
- CN 喷枪



COLOR BOX



Ø 1.4 mm

|           |      |
|-----------|------|
| 410 l/min | 0.6l |
| 0.30 MPa  | HVLP |

|             |  |    |
|-------------|--|----|
| <b>YATO</b> |  |    |
| YT-2340     |  | 20 |

Ø 1.5 mm

|           |      |
|-----------|------|
| 410 l/min | 0.6l |
| 0.30 MPa  | HVLP |

|             |  |    |
|-------------|--|----|
| <b>YATO</b> |  |    |
| YT-2341     |  | 20 |

Ø 1.8 mm

|           |      |
|-----------|------|
| 380 l/min | 1.0l |
| 0.40 MPa  |      |

|             |  |    |
|-------------|--|----|
| <b>YATO</b> |  |    |
| YT-2346     |  | 10 |

Ø 0.8 mm

|           |      |
|-----------|------|
| 220 l/min | 0.1l |
| 0.30 MPa  | HVLP |

|             |  |    |
|-------------|--|----|
| <b>YATO</b> |  |    |
| YT-2357     |  | 20 |



- GB Inflating gun with extension  
D Gebläsepistole mit Verlängerung  
PL Pistolet do przedmuchiwania z przedłużką  
RUS Пистолет для продувки с удлинителем  
CZ Pistolet na profukování dlouhá  
H Rövid előlefevő pisztoly  
RO Pistol lung pt. suflat  
F Pistolet pour purger  
I Pistola professionale  
E Pistola de soplado  
CN 长杆充气枪



1/4"  
6.3mm

0.8  
MPa  
(max.)

AI



**YATO** 

YT-2373

20/40

- GB Washing gun  
D Waschpistole  
PL Pistolet do ropowania  
RUS Пистолет для нефтевания  
CZ Pistolet na ropování + nádrž  
H Olajzöpisztoly + tartály  
RO Pistol (dozator)  
cu rezervor pt. motorină  
F Pistolet à l'huile  
I Pistola di lavaggio con nafta  
E Pistola de petrolear  
CN 喷水枪



0.85l  
130  
l/min

AI

0.80  
MPa



**YATO** 

YT-2374

2/12

- GB Air sand blaster  
D Pistole zum Sandstrahlen  
PL Pistolet do piaskowania z wężem  
RUS Пескоструйный пистолет  
CZ Pískovací pistole s hadicí  
H Homokszóró pisztoly tömlővel  
RO Pistol de sablat  
F Pistolet de sablage avec tuyau  
I Pistola sabbiatrica  
E Pistola para limpieza con chorro  
de arena con manguera  
CN 吹气枪

1/4"  
6.3mm

∅  
6.3 mm

160  
l/min

1m  
HOSE  
WAZ

AI

0.80  
MPa

- GB Gun suitable for sand-blasting  
D Sandstrahlpistole  
PL Pistolet do piaskowania ze zbiornikiem  
RUS Пескоструйный пистолет  
CZ Pískovací pistole se zásobníkem  
H Homokszóró pisztoly tartállyal  
RO Pistol de sablat  
F Pistolet de sablage avec réservoir  
I Pistola sabbiatrica con serbatoio  
E Pistola para limpieza con chorro  
de arena con recip  
CN 喷枪

1.0l  
160  
l/min

AI

0.80  
MPa



**YATO** 

YT-2375

10



**YATO** 

YT-2376

20

GB Mini filter  
D Filter  
PL Filtr  
RUS Минифильтр  
CZ Filtr  
H Szűrő  
RO Minifiltru  
F Vidange mini  
I Filtro  
E Filtro  
CN 微型过滤器

1.4 MPa (max.)

8 cm<sup>3</sup>

1/4" 6.3mm



**YATO**  
YT-2380 25/50

GB Pressure reducing valve with manometer  
D Druckminderer mit Manometer  
PL Reduktor ciśnienia z manometrem  
RUS Клапан уменьшения давления с манометром  
CZ Redukční ventil s manometrem  
H Nyomáscsökkentő szelep nyomásmérővel  
RO Valva cu reductiepresiune + manometru  
F Réducteur avec manomètre  
I Regolatore di pressione con manometro  
E Reductor + manometro  
CN 带表调压减压阀

1.2 MPa (max.)

1/4" 6.3mm



**YATO**  
YT-2381 25/50

GB Filter - reducer  
D Druckfilter - Druckminderer  
PL Filtr - reduktor  
RUS Фильтр - редуктор  
CZ Filtr derukční ventil  
H Szűrő - nyomásszabályzó  
RO Filtru cu reductor  
F Réducteur avec filtre et manomètre  
I Filtro regolatore  
E Reductor + filtro  
CN 过滤器

0.93 MPa (max.)

15 cm<sup>3</sup>

60°C max.

1/4" 6.3mm



**YATO**  
YT-2382 25/50

GB Filter - reducer  
D Druckfilter - Druckminderer  
PL Filtr - reduktor  
RUS Фильтр - редуктор  
CZ Filtr derukční ventil  
H Szűrő - nyomásszabályzó  
RO Filtru cu reductor  
F Réducteur avec filtre et manomètre  
I Filtro regolatore  
E Reductor + filtro  
CN 过滤器

0.93 MPa (max.)

90 cm<sup>3</sup>

60°C max.

1/2" 12.5mm



**YATO**  
YT-2383 25/50

GB Air filter regulator and lubricator  
D Druckfilter - Druckminderer + Entöler  
PL Zespół filtrujący reduktor + smarownica  
RUS Фильтр-редуктор  
CZ Redukční ventil s odlučovačem oleje  
H Levegőelőkészítő  
RO Filtru cu reductor  
F Filtre régulateur lubrificateur pour air comprimé  
I Filtro regolatore lubrificatore  
E Juego de filtro reductor + engrasador  
CN 气动三联件

0.93 MPa (max.)

25 cm<sup>3</sup> FILTER

15 cm<sup>3</sup> LUBRICANT CUP SMAROWNICA

60°C max.

1/4" 6.3mm



**YATO**  
YT-2384 25/50

GB Air filter regulator and lubricator  
D Druckfilter - Druckminderer + Entöler  
PL Zespół filtrujący reduktor + smarownica  
RUS Фильтр-редуктор  
CZ Redukční ventil s odlučovačem oleje  
H Levegőelőkészítő  
RO Filtru cu reductor  
F Filtre régulateur lubrificateur pour air comprimé  
I Filtro regolatore lubrificatore  
E Juego de filtro reductor + engrasador  
CN 气动三联件

0.93 MPa (max.)

90 cm<sup>3</sup> FILTER

60 cm<sup>3</sup> LUBRICANT CUP SMAROWNICA

60°C max.

1/4" 6.3mm



**YATO**  
YT-2385 25



GB Quick coupler  
D Schnellkupplung  
PL Szybkozłącze  
RUS Быстрое соединение

CZ Rychlospojka  
H Gyorscsatlakozó  
RO Mufa rapida pt. pistol pneumatic  
F Raccord rapide

I Attacco rapido  
E Conexión de la entrada de aire  
CN 快速接头

SLIDING CARD

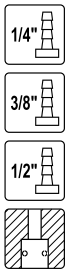
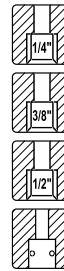
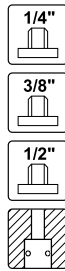

| YATO    | size / rozmiar |        |
|---------|----------------|--------|
| YT-2390 | 1/4" (6.3 mm)  | 50/250 |
| YT-2391 | 3/8" (10.0 mm) | 50/250 |
| YT-2392 | 1/2" (12.5 mm) | 50/250 |

| YATO    | size / rozmiar |        |
|---------|----------------|--------|
| YT-2393 | 1/4" (6.3 mm)  | 50/250 |
| YT-2394 | 3/8" (10.0 mm) | 50/250 |
| YT-2395 | 1/2" (12.5 mm) | 50/250 |

| YATO    | size / rozmiar |        |
|---------|----------------|--------|
| YT-2396 | 1/4" (6.3 mm)  | 50/250 |
| YT-2397 | 3/8" (10.0 mm) | 50/250 |
| YT-2398 | 1/2" (12.5 mm) | 50/250 |

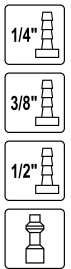
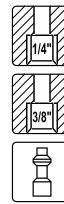
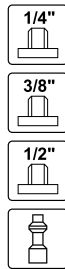

| YATO    | size / rozmiar |        |
|---------|----------------|--------|
| YT-2399 | 1/4" (6.3 mm)  | 50/250 |
| YT-2401 | 3/8" (10.0 mm) | 50/250 |
| YT-2402 | 1/2" (12.5 mm) | 50/250 |

| YATO    | size / rozmiar |        |
|---------|----------------|--------|
| YT-2403 | 1/4" (6.3 mm)  | 50/250 |
| YT-2404 | 3/8" (10.0 mm) | 50/250 |

| YATO    | size / rozmiar |        |
|---------|----------------|--------|
| YT-2405 | 1/4" (6.3 mm)  | 50/250 |
| YT-2406 | 3/8" (10.0 mm) | 50/250 |
| YT-2407 | 1/2" (12.5 mm) | 50/250 |

GB 2 way quick coupler  
D Zwei-wege schnellkupplung  
PL Szybkozłącze podwójne  
RUS Двусторонняя быстроразъемные соединения  
CZ Two-way rychlospojky  
H Levegőelosztó kettős gyorscsatlakozó  
RO Distribuitoare cuple rapide  
F Dérivation type y en cuivre  
I Raccordo ottone con vie  
E Manera 2 manguera de aire pase de acoplamiento rápido  
CN 三通万用插嘴



GB Quick coupler  
D Schnellkupplung  
PL Szybkozłącze  
RUS Быстрое соединение  
CZ Rychlospojka  
H Gyorscsatlakozó  
RO Mufa rapida pt. pistol pneumatic  
F Raccord rapide  
I Attacco rapido  
E Conexión de la entrada de aire  
CN 快速接头



GB Quick coupler  
D Schnellkupplung  
PL Szybkozłącze  
RUS Быстрое соединение  
CZ Rychlospojka  
H Gyorscsatlakozó  
RO Mufa rapida pt. pistol pneumatic  
F Raccord rapide  
I Attacco rapido  
E Conexión de la entrada de aire  
CN 快速接头

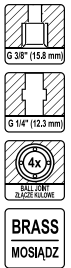

SLIDING CARD



SLIDING CARD



SLIDING CARD

| YATO     |       |
|----------|-------|
| YT-24091 | 25/50 |

| YATO     |        |
|----------|--------|
| YT-24092 | 50/100 |

| YATO     |        |
|----------|--------|
| YT-24093 | 50/100 |

GB Quick coupler  
D Schnellkupplung  
PL Szybkozłącze  
RUS Быстрое соединение  
CZ Rychlospojka  
H Gyorscsatlakozó

RO Mufa rapida pt. pistol pneumatic  
F Raccord rapide  
I Attacco rapido  
E Conexión de la entrada de aire  
CN 快速接头

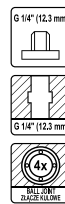

SLIDING CARD

| YATO     |        |
|----------|--------|
| YT-24094 | 50/100 |

GB Quick coupler  
D Schnellkupplung  
PL Szybkozłącze  
RUS Быстрое соединение  
CZ Rychlospojka  
H Gyorscsatlakozó

RO Mufa rapida pt. pistol pneumatic  
F Raccord rapide  
I Attacco rapido  
E Conexión de la entrada de aire  
CN 快速接头



SLIDING CARD

| YATO     |        |
|----------|--------|
| YT-24095 | 50/100 |

GB Air grease gun  
 D Druckluft-Fettpresse  
 PL Smarownica pneumatyczna  
 RUS Шприц для нагнетания  
 густой смазки пневматический  
 CZ Mazací lis pneumatický  
 H Pneumatikus zsírzó

RO Pistol pt. gresat pneumatic  
 F Pistolet de graissage pneumatique  
 I Pneumatica per ingrassaggio  
 E Pistola engrasadora neumática  
 CN 气动黄油枪

400 cm<sup>3</sup>  
 28 l/min  
 1/4"  
 6.3mm

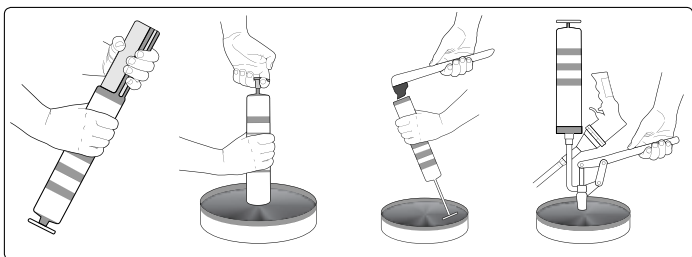

|             |    |
|-------------|----|
| <b>YATO</b> |    |
| YT-07055    | 10 |

GB Pneumatic riveting machine  
 D Pneumatische Nietvorrichtung  
 PL Nitownica pneumatyczna  
 RUS Пневматический заклепочник  
 CZ Pneumatická nýtovačka  
 H Pneumatikus popszegecszhúzó

RO Presa pneumatica de nituri  
 F Riveuse pneumatique  
 I Rivettatrice pneumatica  
 E Máquina remachadora  
 CN 气动拉铆枪



STAINLESS STEEL, STEEL, ALUMINIUM  
 STAL, NIERZEWNA, STAL, ALUMINIUM  
 1/4"  
 6.3mm  
 0.62 MPa

15



**x4** • application: industry  
 • przeznaczenie: przemysł

**x5** • application: industry  
 • przeznaczenie: przemysł

| YATO    | Ø (mm)             | L (mm) | F (kg) | F (N) |    |
|---------|--------------------|--------|--------|-------|----|
| YT-3617 | 2.4; 3.2; 4.0; 4.8 | 14     | 850    | 8335  | 10 |

| YATO    | Ø (mm)                  | L (mm) | F (kg) | F (N) |   |
|---------|-------------------------|--------|--------|-------|---|
| YT-3618 | 2.4; 3.2; 4.0; 4.8; 6.4 | 16     | 1389   | 13620 | 6 |



GB Pneumatic stitching machine  
D Drucklufthefter  
PL Zszywacz pneumatyczny  
RUS Пневматический шиватель  
CZ Pneumatická sešivačka  
H Pneumatikus tűzőgép

RO Capsator pneumatic  
F Agrafeuse pneumatique  
I Cucitrice pneumatica  
E Engrapadora pneumatica  
CN 气动码钉枪

7  
bar

8-25  
mm

1/4"  
6.3 mm

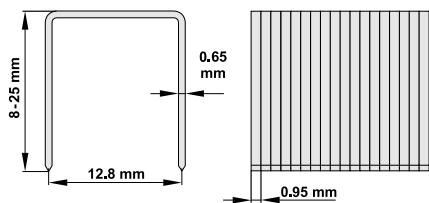

BMC  
& COLOR  
SLEEVE

- application: industry, construction
- przeznaczenie: przemysł, budownictwo

**YATO**  
YT-0920 5

GB Pneumatic nailing machine  
D Druckluftnagelgerät  
PL Gwoździarka pneumatyczna  
RUS Пневматическая гвоздильная машина  
CZ Pneumatický nastřelovač hřebíků  
H Pneumatikus szögbelevő  
RO Capsator pneumatic

F Cloueur pneumatique  
I Chiodatrice pneumatica  
E Maquina pneumatica para clavar clavos  
CN 气动码钉枪

8  
bar

25-64  
mm

90°

1/4"  
6.3 mm

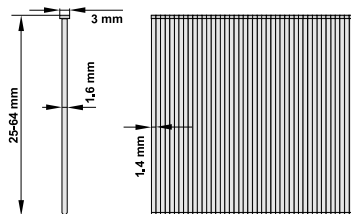

BMC  
& COLOR  
SLEEVE

- application: industry, construction
- przeznaczenie: przemysł, budownictwo

**YATO**  
YT-0921 5

GB Pneumatic nailing machine  
D Druckluftnagelgerät  
PL Gwoździarka pneumatyczna  
RUS Пневматическая гвоздильная машина  
CZ Pneumatický nastřelovač hřebíků  
H Pneumatikus szögbelevő  
RO Capsator pneumatic  
F Cloueur pneumatique  
I Chiodatrice pneumatica  
E Maquina pneumatica para clavar clavos  
CN 气动码钉枪

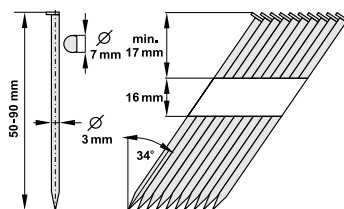

BMC  
& COLOR  
SLEEVE

- application: industry, construction
- przeznaczenie: przemysł, budownictwo

**YATO**  
YT-0923 2

GB Mini palm nailer  
D Drucklufthammer für Nägel  
PL Młotek pneumatyczny do gwoździ  
RUS Пневматический молоток для забивания гвоздей  
CZ Pneumatická hřebíkovačka  
H Pneumatikus szögbeütő kalapács  
RO Ciocan pneumatic pt. cuie  
F Cloueur pneumatique  
I Chiodatrice pneumatica  
E Maquina pneumatica para clavar clavos  
CN 迷你气动钉枪

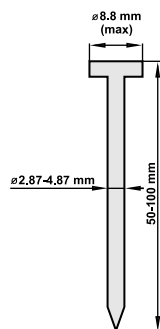

0.70  
MPa

1/4"  
6.3 mm

COLOR BOX

**YATO**  
YT-0925 20













# 16

**Special automotive tools  
& equipment**

**Narzędzia i wyposażenie  
warsztatu samochodowego**





|   |   |   |   |
|---|---|---|---|
| <b>Cabinets</b><br>Szafki   |    | <b>Spark plug sockets</b><br>Klucze do świec.....   | 349   |
| .....   | 291-307   | <b>Brake system tools</b><br>Narzędzia do obsługi układu hamulcowego                                |    |
| <b>Roller cabinets with tools insert</b><br>Szafki serwisowe z narzędziami.....               | 291   | .....   | 350-354   |
| <b>Tool cabinets</b><br>Szafki serwisowe.....   | 296   | <b>Suspension system tools</b><br>Narzędzia do obsługi podwozia                                     |    |
| <b>Workbenches</b><br>Stoły warsztatowe.....  | 300   | .....   | 355-358   |
| <b>Tools in PVC trays</b><br>Zestawy narzędzi do szuflad.....                                 | 300   | <b>Spring clamps &amp; accessories</b><br>Ściągacze do sprężyn i akcesoria.....                     | 355   |
| <b>Accessories for tool cabinets &amp; workbenches</b><br>Akcesoria do szafek i stołów.....   | 306   | <b>Shock absorber nut sets</b><br>Zestawy nasadek do amortyzatorów.....                             | 356   |
| <b>Tool boxes</b><br>Skrzynki narzędziowe   |    | <b>Tire valve stem inserter</b><br>Przeciągacze do zaworów gumowych.....                            | 356   |
| .....   | 308-310   | <b>Wheel balance pliers</b><br>Szczypce do wyważania kół.....                                       | 357   |
| <b>Lubrication system tools</b><br>Narzędzia do obsługi układu smarowania                     |    | <b>Deep thin wall impact sockets 1/2"</b><br>Udarowe klucze nasadowe 1/2" do felg aluminiowych..... | 357   |
| .....   | 311-317   | <b>Valve core torque tools</b><br>Klucze dynamometryczne do zaworów gumowych i metalowych.....      | 357   |
| <b>Oil filter wrenches &amp; sets</b><br>Klucze do filtra oleju i zestawy.....                | 311   | <b>Wheel wrenches</b><br>Klucze do kół.....   | 358   |
| <b>Oil drain plug sockets</b><br>Klucze do spustu oleju.....                                  | 313   | <b>Tire levels</b><br>Łyżki do opon.....  | 358   |
| <b>Grease guns &amp; accessories</b><br>Smarownice ręczne, pneumatyczne i akcesoria.....      | 314   | <b>Workshop tools</b><br>Narzędzia warsztatowe  |   |
| <b>Oil cans</b><br>Oliwiarki.....   | 317   | .....   | 358-366   |
| <b>Oil and fuel pumps</b><br>Pompy do oleju oraz paliwa.....                                  | 317   | <b>Flexi shafts</b><br>Wałki giętkie.....   | 358   |
| <b>Pullers</b><br>Ściągacze   |  | <b>Inspection tools</b><br>Narzędzia inspekcyjne.....   | 359   |
| .....   | 318-331   | <b>Magnetic pick up tools</b><br>Chwytyki magnetyczne.....  | 360   |
| <b>Pullers</b><br>Ściągacze.....  | 318   | <b>Magnetic trays</b><br>Tacki magnetyczne.....   | 360   |
| <b>Roller stud extractor sets</b><br>Zestawy ściągaczy do szpilek.....                        | 323   | <b>Tweezers</b><br>Pęsety.....  | 361   |
| <b>Upholstery removers</b><br>Ściągacze do tapicerki.....                                     | 331   | <b>Workshop creepers</b><br>Leżanki warsztatowe.....  | 361   |
| <b>Car window tools</b><br>Narzędzia do szyb samochodowych                                    |  | <b>LED workshop lightning</b><br>Oświetlenie warsztatowe LED.....                                   | 362   |
| .....   | 331-332   | <b>Breathalyzers</b><br>Alkomaty.....   | 364   |
| <b>Air condition tools</b><br>Narzędzia do klimatyzacji                                       |  | <b>Voltage testers</b><br>Próbniki napięcia.....  | 365   |
| .....   | 332   | <b>Number &amp; letter stamps</b><br>Znaczniki cyfrowe i literowe.....                              | 365   |
| <b>Fuel feel pipe pliers</b><br>Szczypce motoryzacyjne  |  | <b>Thread repair sets &amp; accessories</b><br>Zestawy do naprawy gwintów i akcesoria.....          | 365   |
| .....   | 333-337   | <b>Tire pressure gauges</b><br>Mierniki ciśnienia.....  | 366   |
| <b>Engine repair tools</b><br>Narzędzia do obsługi silnika                                    |  | <b>Pumps</b><br>Pompki.....   | 366   |
| .....   | 338-349   | <b>Funnels, oil drainer &amp; drainer pans</b><br>Lejki, miski i zlewarki do oleju                  |  |
| <b>Piston ring compressors</b><br>Zaciskacze do pierścieni.....                               | 338   | .....   | 367   |
| <b>Engine repair and diagnostic tools</b><br>Narzędzia do diagnostyki i naprawy silników..... | 338   | <b>Bottle &amp; floor jacks</b><br>Dźwigniki słupkowe i podnośniki                                  |  |
| .....   | 338-349   | .....   | 368-369   |



Work benches  
Stojaki lakiernicze

369



Electric hoists  
Elektryczne wciągarki linowe

373



Refractometers  
Refraktometry

369



Hand pullers  
Wciągarki linowe, ręczne

373



Battery chargers & battery testers  
Prostowniki i testery akumulatorów

370-372



Shop cranes & shop presses  
Żurawie i prasy warsztatowe

374-375



Chain blocks  
Wciągarki łańcuchowe

373



Workshop standardized parts  
Normalia motoryzacyjne

376-377





GB Service tool cabinet with tools  
D Serviceschrank mit Werkzeugen  
PL Szafka serwisowa z narzędziami  
RUS Сервисный шкаф с инструментами  
CZ Servisní skříňka s nářadím  
H Szervizszekrény szerszámokkal

RO Cutie de service cu scule  
F Servante d'atelier - set d'outils  
I Armadio per utensili  
E Armario para herramientas de servicio  
CN 工具车托盘组套

WHITE  
CARTON BOX  
& COLOR LABEL



141 PCS  
12 TRAY  
WKLAD

665x453  
x932 mm

7x

BALL BEARING  
ŁOŻYSKA  
KULKOWE

25kg  
35kg  
35kg

DRAWERS  
LOCKING  
BLOKADA  
SZUFLAD

NON SLIP  
POSLIPIE  
WOKTOP  
ANTIPOŚLIZGOWY  
POLIPROPYLENOWY  
BLAT

WHEELS  
KÓŁKA

WHEEL  
KÓŁKA  
125  
mm

UNIVERSAL  
PERFORATION  
UNIERSALNA  
PERFORACJA

2x  
BRAKE  
HAMULCE

2x1



12 interchangeable trays with YATO tools  
12 wymiennych modułów z narzędziami YATO

**DRAWER / SZUFLADA 1**

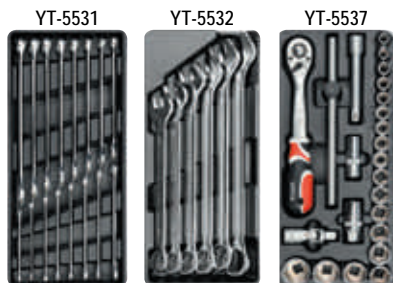

**DRAWER / SZUFLADA 2**

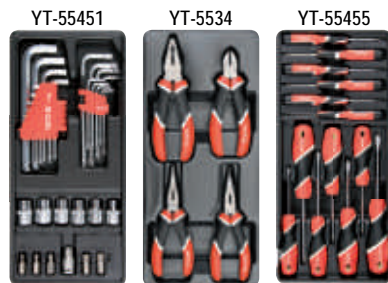

**DRAWER / SZUFLADA 3**



**DRAWER / SZUFLADA 4**



**DRAWER / SZUFLADA 1**

1/2" (12.7 mm): 10, 11, 12, 13, 14, 15, 16, 17, 18, 19, 20, 21, 22, 23, 24, 27, 30, 32 mm; CrV 50BV30: 1/2" (12.7 mm): (255 mm); 72T; CrV 6140: 1/2" (12.7 mm): (255 mm); CrV 50BV30: 1/2" (12.7 mm): (127 mm); CrV 50BV30: 6, 7, 8, 9, 10, 11, 12, 13, 14, 15, 16, 17, 18, 19, 20, 21 mm; CrV: 22, 24, 27, 28, 30, 32 mm; CrV

**DRAWER / SZUFLADA 2**

1/2" (12.7 mm): E10, E12, E14, E16, E18, E20 (L=38 mm); CrV 50BV30: M5, M6, M7, M10, M12 (L=30 mm); AISI S2: 1/2" (12.7 mm): 10 mm; CrV 6150: 2, 2.5, 3, 4, 5, 6, 7, 8, 10, 12 mm; CrV 6150: T10, T15, T20, T25, T27, T30, T40, T45, T50; CrV 6150: 180 mm; 160 mm; 160 mm LONG NOSE: 160 mm BENT NOSE: 3x75, 4x100, 5x75, 6x100 mm; S2: 1.4x50, 2.0x50, 2.4x50 mm; PH0x50, PH0x50, PH1x50 mm; S2: PH0x75, PH1x75, PH2x100 mm; S2

**DRAWER / SZUFLADA 3**

300 g (L=300 mm); 40 mm (L=350 mm); 10x8x142 mm, 12x10x152 mm, 16x13x172 mm; 250 mm; CrV: 125 mm; CrMo: 300 mm; CrV: 140 mm; 200 mm; 19 mm x 20 mm; 4x190 mm; 250 V: 1.0, 1.5, 2.0, 2.5, 3.0, 3.5, 4.0, 4.5, 5.0, 5.5, 6.0, 6.5, 7.0, 7.5, 8.0, 8.5, 9.0, 9.5, 10.0 mm

**DRAWER / SZUFLADA 4**

#2, 200 mm; #2, 200 mm; #2, 200 mm; #2, 200 mm; 300 mm; 0-150 mm; 2 m; 3m x 16 mm; 0.02-1.00 mm; 2.4, 3.2, 4.0, 4.8 mm; 9.6x3.2, 9.6x4.0, 12.7x4.0, 9.6x4.8, 12.7x4.8 mm

|             |                           |   |
|-------------|---------------------------|---|
| <b>YATO</b> | <b>drawers / szuflady</b> |   |
| YT-55291    | 7                         | 1 |



GB Service tool cabinet with tools  
 D Serviceschrank mit Werkzeugen  
 PL Szafka serwisowa z narzędziami  
 RUS Сервисный шкаф с инструментами  
 CZ Servisní skříňka s nářadím  
 H Szerviszszekrény szerszámokkal

RO Cutie de service cu scule  
 F Servante d'atelier - set d'outils  
 I Armadio per utensili  
 E Armario para herramientas de servicio  
 CN 工具车托盘组套

WHITE  
 CARTON BOX  
 & COLOR LABEL



|   |  |   |   |
|---|--|---|---|
| <b>165</b><br>PCS<br><b>13</b><br>TRAY<br>WKŁAD       | <b>958x766</b><br>x <b>465</b> mm  | <b>7x</b><br>BALL BEARING<br>ŁOŻYSKA<br>KULKOWE | <b>25kg</b><br>↓<br><b>35kg</b><br>↑      |
| <b>3x</b><br>DRAWERS<br>LOCKING<br>BLOKADA<br>SZUFLAD | <b>NON SLIP</b><br>POLYPROPYLENE<br>WORKTOP<br>ANTYPOŚLIZGOWY<br>POLIPROPYLENOWY<br>BLAT | <b>WHEEL</b><br>KÓŁKA                           | <b>WHEEL</b><br>KÓŁKA<br><b>125</b><br>mm |
| <b>3x</b><br>KEY                                      | <b>UNIVERSAL PERFORATION</b><br>UNIWERSALNA<br>PERFORACJA                                | <b>2x</b><br>BRAKE<br>HAMULCE                   | <b>DOUBLE WALLS</b><br>PODWÓJNE<br>SCIANY |
| <b>CORNER BUMPERS</b><br>NARÓZNE ODBOJNIKI            |  |   |   |



**13 interchangeable trays with YATO tools**  
**13 wymiennych modułów z narzędziami YATO**

**DRAWER / SZUFLADA 1**

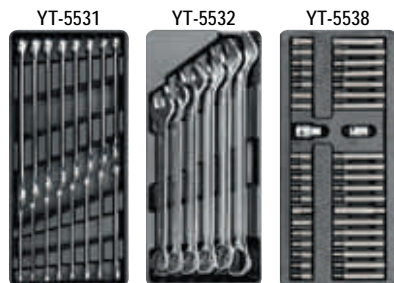

**DRAWER / SZUFLADA 2**

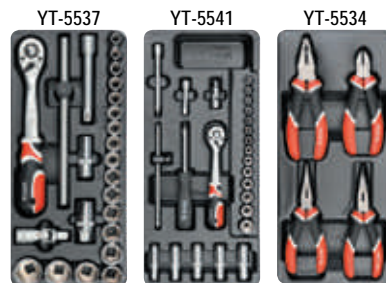

**DRAWER / SZUFLADA 3**

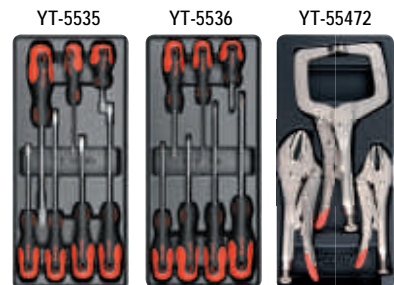

**DRAWER / SZUFLADA 4**



**DRAWER / SZUFLADA 5**



**DRAWER / SZUFLADA 1**

○ □ □ □ H4, H5, H6, H7, H8, H10, H12 (L=30 mm); H4, H5, H6, H7, H8, H10, H12 (L=75 mm); AISI S2: ○ □ □ □ M5, M6, M7, M10, M12 (L=30 mm); M5, M6, M7, M10, M12 (L=75 mm); AISI S2: ○ □ □ □ T20, T25, T30, T40, T45, T50, T55 (L=30 mm); T20, T25, T30, T40, T45, T50, T55 (L=75 mm); AISI S2: ○ □ □ □ 1/2" (127 mm), 3/8" (9.5 mm); ○ □ □ □ 6, 7, 8, 9, 10, 11, 12, 13, 14, 15, 16, 17, 18, 19, 20, 21 mm; CrV; ○ □ □ □ 22, 24, 27, 28, 30, 32 mm; CrV

**DRAWER / SZUFLADA 2**

○ □ □ □ 1/2" (12.7 mm): 10, 11, 12, 13, 14, 15, 16, 17, 18, 19, 20, 21, 22, 23, 24, 27, 30, 32 mm; CrV 50BV30: ○ □ □ □ 1/2" (12.7 mm); (255 mm); 72T: CrV 6140: ○ □ □ □ 1/2" (12.7 mm); (255 mm); CrV 50BV30: ○ □ □ □ 1/2" (12.7 mm); (127 mm); CrV 50BV30: ○ □ □ □ 1/2" (12.7 mm); CrV 50BV30: ○ □ □ □ 1/4" (6.3 mm); 8, 10, 11, 12, 13 mm; CrV 50BV30: ○ □ □ □ 1/4" (6.3 mm); (50.8, 101.6 mm); CrV 6140: ○ □ □ □ 1/4" (6.3 mm); CrV 50BV30: ○ □ □ □ 1/4" (6.3 mm); (155 mm); 72T: CrV 6140: ○ □ □ □ 1/4" (6.3 mm); (150 mm); CrV 50BV30: ○ □ □ □ 1/4" (6.3 mm); (152.4 mm); CrV 50BV30: ○ □ □ □ 180 mm; 160mm; ○ □ □ □ 160 mm LONG NOSE; ○ □ □ □ 160 mm BENT NOSE

**DRAWER / SZUFLADA 3**

○ □ □ □ 3x75, 5x100, 5x150, 6x38, 6x100, 6x150, 8x150 mm; CrMo; ○ □ □ □ PH0x100, PH1x75, PH1x100, PH2x38, PH2x100, PH2x150, PH3x150 mm; CrMo; ○ □ □ □ 180, 250 mm; ○ □ □ □ 280 mm

**DRAWER / SZUFLADA 4**

○ □ □ □ 3/4" (19.0 mm): 21, 22, 24, 27, 28, 29, 30, 32, 34, 36, 41, 46, 50, 55 mm; CrV 50BV30: ○ □ □ □ 3/4" (19.0 mm); (200 mm); CrV 6140: ○ □ □ □ 3/4" (19.0 mm); CrV 50BV30: ○ □ □ □ 3/4" (19.0 mm); (500 mm); 72T: CrV 6140: ○ □ □ □ 3/4" (19.0 mm); (500 mm); CrV 50BV30

**DRAWER / SZUFLADA 5**

○ □ □ □ 1/2" (12.7 mm) x 5/16" (7.9 mm); ○ □ □ □ PH3 (L=35 mm); PH1, PH2, PH3 (L=75 mm); ○ □ □ □ 8 mm (L=35 mm); 8 mm (L=75 mm); ○ □ □ □ 12-38 mm; ○ □ □ □ 3" (75 mm); ○ □ □ □ 82 mm; ○ □ □ □ 200 mm; ○ □ □ □ 135 mm; ○ □ □ □ 300, 400, 500 mm

|             |                           |   |
|-------------|---------------------------|---|
| <b>YATO</b> | <b>drawers / szuflady</b> |   |
| YT-55293    | 7                         | 1 |



GB Service tool cabinet with tools  
D Serviceschrank mit Werkzeugen  
PL Szafka serwisowa z narzędziami  
RUS Сервисный шкаф с инструментами  
CZ Servisní skříňka s nářadím  
H Szervizszekrény szerszámokkal

RO Cutie de service cu scule  
F Servante d'atelier - set d'outils  
I Armadio per utensili  
E Armario para herramientas de servicio  
CN 工具车托盘组套

WHITE  
CARTON BOX  
& COLOR LABEL



177 PCS  
12 TRAY WKLD

958x766  
x465 mm

6x

BALL BEARING  
ŁOŻYSKA  
KULKOWE

DRAWERS  
LOCKING  
BLOKADA  
SZUFLAD

NON SLIP  
POLYPROPYLENE  
WORKTOP  
ANTYPOŚLIZGOWY  
POLIPROPYLENOWY  
BLAT

WHEELS  
KÓŁKA

WHEEL Ø  
125  
KÓŁKA

UNIVERSAL  
PERFORATION  
UNIWEERSALNA  
PERFORACJA

2x  
BRAKE  
HAMULCE

2x1

DOUBLE  
WALLS  
PODWÓJNE  
SCIANY

CORNER BUMPERS  
NAROŻNE ODBOJNIKI



12 interchangeable trays with YATO tools  
12 wymiennych modułów z narzędziami YATO

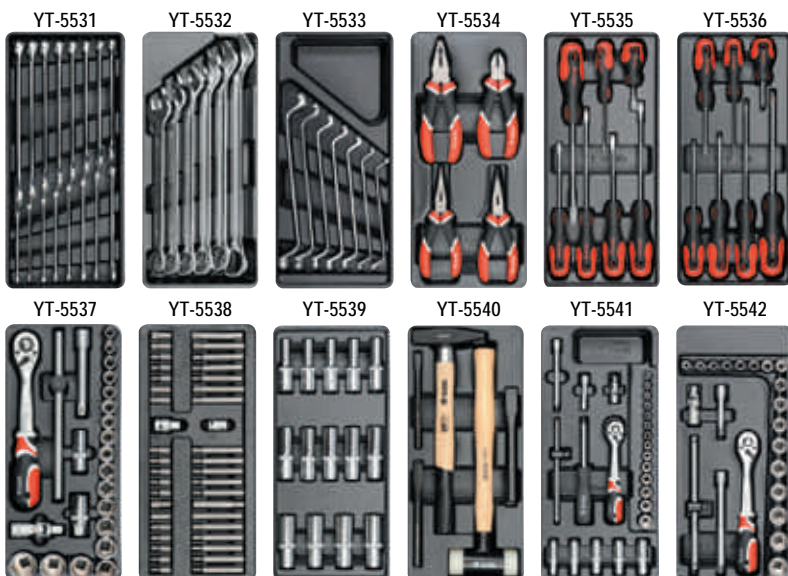

**DRAWER / SZUFLADA 1**

3/8" (9.5 mm): 6, 7, 8, 9, 10, 11, 12, 13, 14, 15, 16, 17, 18, 19, 20, 21, 22 mm; CrV 50BV30; 3/8" (9.5 mm): (76, 152.4 mm); CrV 50BV30; 3/8" (9.5 mm); CrV 50BV30; 3/8" (9.5 mm); (200 mm); 72T; CrV 6140; 3/8" (9.5 mm); (198 mm); CrV 50BV30; 1/2" (12.7 mm): 10, 11, 12, 13, 14, 15, 16, 17, 18, 19, 20, 21, 22, 23, 24, 27, 30, 32 mm; CrV 50BV30; 1/2" (12.7 mm); (127 mm); CrV 50BV30; 1/2" (12.7 mm); CrV 50BV30; 1/2" (12.7 mm); (255 mm); 72T; CrV 6140; 1/2" (12.7 mm); (255 mm); CrV 50BV30; 1/2" (12.7 mm); 16; 21 mm; CrV 50BV30; 1/4" (6.3 mm): 3.5, 4, 4.5, 5, 5.5, 6, 7, 8, 9, 10, 11, 12, 13, 14 mm; CrV 50BV30; 1/4" (6.3 mm): 8, 10, 11, 12, 13 mm; CrV 50BV30; 1/4" (6.3 mm): (50.8, 101.6 mm); CrV 6140; 1/4" (6.3 mm); CrV 50BV30; 1/4" (6.3 mm); (155 mm); 72T; CrV 6140; 1/4" (6.3 mm); (150 mm); CrV 50BV30; 1/4" (6.3 mm); (152.4 mm); CrV 50BV30

**DRAWER / SZUFLADA 2**

3x75, 5x100, 5x150, 6x38, 6x100, 6x150, 8x150 mm; CrMo; PH0x100, PH1x75, PH1x100, PH2x38, PH2x100, PH2x150, PH3x150 mm; CrMo; 180mm; 160mm; 160 mm LONG NOSE; 160 mm BENT NOSE

**DRAWER / SZUFLADA 3**

22, 24, 27, 28, 30, 32 mm; CrV; 6, 7, 8, 9, 10, 11, 12, 13, 14, 15, 16, 17, 18, 19, 20, 21 mm; CrV; 1/2" (12.7 mm): 8, 9, 10, 11, 12, 13, 14, 15, 16, 17, 18, 19, 20, 21 mm (L=76 mm); CrV 50BV30

**DRAWER / SZUFLADA 4**

300 g (L=300 mm); 40 mm (L=350 mm); 10x8x142 mm, 12x10x152 mm, 16x13x172 mm; H4, H5, H6, H7, H8, H10, H12 (L=30 mm); H4, H5, H6, H7, H8, H10, H12 (L=75 mm); AISI S2; M5, M6, M7, M10, M12 (L=30 mm); M5, M6, M7, M10, M12 (L=75 mm); AISI S2; T20, T25, T30, T40, T45, T50, T55 (L=30 mm); T20, T25, T30, T40, T45, T50, T55 (L=75 mm); AISI S2; 1/2" (12.7 mm); 3/8" (9.5 mm); 6x7, 8x9, 10x11, 12x13, 14x15, 16x17, 18x19 mm; CrV

| YATO    | drawers / szuflady |   |
|---------|--------------------|---|
| YT-5530 | 6                  | 1 |



GB Service tool cabinet with tools  
 D Serviceschrank mit Werkzeugen  
 PL Szafka serwisowa z narzędziami  
 RUS Сервисный шкаф с инструментами  
 CZ Servisní skříňka s náradím  
 H Szervizszekrény szerszámokkal

RO Cutie de service cu scule  
 F Servante d'atelier - set d'outils  
 I Armadio per utensili  
 E Armario para herramientas de servicio  
 CN 工具车托盘组套

WHITE  
 CARTON BOX  
 & COLOR LABEL



|   |   |                    |                                     |   |
|---|---|--------------------|-------------------------------------|---|
| <b>189 PCS</b><br>14 TRAY WKLAD                     | <b>958x766 x465 mm</b>  | <b>7x</b>          | <b>BALL BEARING ŁOŻYSKA KULKOWE</b> | <b>25kg</b><br>35kg<br>35kg             |
| <b>DRAWERS LOCKING BLOKADA SZUFLAD</b>              | <b>NON SLIP POLYPROPYLENE WORKTOP ANTYPOŚLIZGOWY POLIPROPILENOWY BLAT</b> | <b>WHEEL KÓŁKA</b> | <b>WHEEL Ø 125 mm</b>               |   |
| <b>UNIVERSAL PERFORMANCE UNIWERSALNA PERFORACJA</b> | <b>DOUBLE WALLS PODWÓJNE ŚCIANY</b>                                       | <b>3x</b>          | <b>2x BRAKE HAMULCE</b>             | <b>CORNER BUMPERS NARÓŻNE ODBOJNIKI</b> |



**14 interchangeable trays with YATO tools**  
**14 wymiennych modułów z narzędziami YATO**

**DRAWER / SZUFLADA 1**

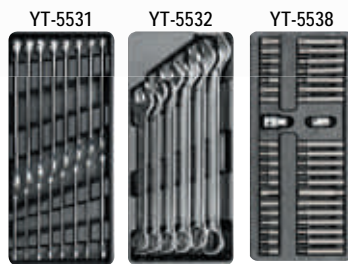

**DRAWER / SZUFLADA 1**

○ H4, H5, H6, H7, H8, H10, H12 (L=30 mm); H4, H5, H6, H7, H8, H10, H12 (L=75 mm); AISI S2: ○ M5, M6, M7, M10, M12 (L=30 mm); M5, M6, M7, M10, M12 (L=75 mm); AISI S2: ○ T20, T25, T30, T40, T45, T50, T55 (L=30 mm); T20, T25, T30, T40, T45, T50, T55 (L=75 mm); AISI S2: ○ 1/2" (12.7 mm), 3/8" (9.5 mm); ○ 6, 7, 8, 9, 10, 11, 12, 13, 14, 15, 16, 17, 18, 19, 20, 21 mm; CrV: ○ 22, 24, 27, 28, 30, 32 mm; CrV

**DRAWER / SZUFLADA 2**

○ 1/2" (12.7 mm); 10, 11, 12, 13, 14, 15, 16, 17, 18, 19, 20, 21, 22, 23, 24, 27, 30, 32 mm; CrV 50BV30; ○ 1/2" (12.7 mm); (255 mm); 72T; CrV 6140; ○ 1/2" (12.7 mm); (255 mm); CrV 50BV30; ○ 1/2" (12.7 mm); (127 mm); CrV 50BV30; ○ 1/2" (12.7 mm); CrV 50BV30; ○ 180 mm; ○ 160 mm; ○ 160 mm LONG NOSE; ○ 160 mm BENT NOSE; ○ 300 g (L=300 mm); ○ 40 mm (L=350 mm); ○ 10x8x142 mm, 12x10x152 mm, 16x13x172 mm

**DRAWER / SZUFLADA 3**

○ 3x75, 4x100, 5x75, 6x100 mm; S2: ○ 1.4x50, 2.0x50, 2.4x50 mm; PH00x50, PH0x50, PH1x50 mm; PH0x75, PH1x75, PH2x100 mm; S2: ○ 200, 250 mm; CrV: ○ 250 mm; CrMo: ○ 180 mm; CrV

**DRAWER / SZUFLADA 4**

○ 3x: M3x0.5, M4x0.7, M5x0.8, M6x1.0, M7x1.0, M8x1.25, M10x1.5, M12x1.75; ○ M3x0.5, M4x0.7, M5x0.8, M6x1.0, M7x1.0, M8x1.25, M10x1.5, M12x1.75; ○ 0.5 - 1.75 mm; 27G; 28G; ○ M7-M9; ○ M3-M12; ○ 180 mm; EXTERNAL STRAIGHT; ○ 180 mm; INTERNAL STRAIGHT; ○ 180 mm; EXTERNAL BENT; ○ 180 mm; INTERNAL BENT; ○ #2, 200 mm; ○ #2, 200 mm; ○ #2, 200 mm; ○ #2, 200 mm

**DRAWER / SZUFLADA 5**

○ 140 mm; ○ 200 mm; ○ 19 mm x 20 mm; ○ 4x190 mm; 250 V; ○ 1.0, 1.5, 2.0, 2.5, 3.0, 3.5, 4.0, 4.5, 5.0, 5.5, 6.0, 6.5, 7.0, 7.5, 8.0, 8.5, 9.0, 9.5, 10.0 mm; ○ 1" (25 mm), L=330 mm; ○ 250 mm; ○ 2.4, 3.2, 4.0, 4.8 mm; ○ 9.6x3.2, 9.6x4.0, 12.7x4.8 mm

|             |                           |   |
|-------------|---------------------------|---|
| <b>YATO</b> | <b>drawers / szuflady</b> |   |
| YT-55292    | 7                         | 1 |

**DRAWER / SZUFLADA 2**

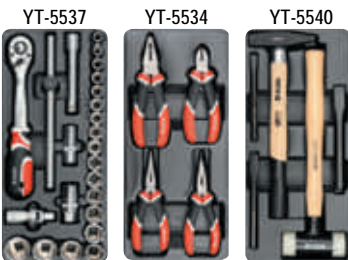

**DRAWER / SZUFLADA 3**



**DRAWER / SZUFLADA 4**

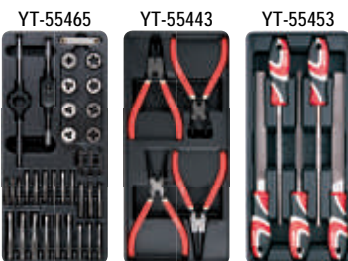

**DRAWER / SZUFLADA 5**





GB Service tool cabinet with tools  
D Serviceschrank mit Werkzeugen  
PL Szafka serwisowa z narzędziami  
RUS Сервисный шкаф с инструментами  
CZ Servisní skříňka s nářadím  
H Szervizszekrény szerszámokkal

RO Cutie de service cu scule  
F Servante d'atelier - set d'outils  
I Armadio per utensili  
E Armario para herramientas de servicio  
CN 工具车托盘组套

WHITE  
CARTON BOX  
& COLOR LABEL



211 PCS  
5 TRAY  
WKLAD

980x770  
x465 mm

7x

BALL BEARING  
ŁOŻYSKA  
KULKOWE

25kg  
35kg

DRAWERS  
LOCKING  
BLOKADA  
SZUFLAD

NON SLIP  
POLYPROPYLENE  
WORKTOP  
ANTYPOŚLIZGOWY  
POLIPROPYLENOWY  
BLAT

WHEELS  
KÓŁKA

WHEEL Ø  
KÓŁKA mm

UNIVERSAL  
PERFORMANCE  
UNIWERSALNA  
PERFORACJA

3xT

2x  
BRAKE  
HAMULCE

DOUBLE  
WALLS  
PODWÓJNE  
SCIANY

CORNER BUMPERS  
NARÓŻNE ODBOJNIKI



**DRAWER / SZUFLADA 1**

1/2" (12.7 mm): 8, 9, 10, 11, 12, 13, 14, 15, 16, 17, 18, 19, 20, 21, 22, 24 (L=38 mm); 27, 30, 32 mm (L=42 mm); 1/4" (6.3 mm): 4, 4.5, 5, 5.5, 6, 7, 8, 9, 10, 11, 12, 13 (L=25 mm); CrV 50BV30: 1/2" (12.7 mm): 10, 13, 14, 15, 17, 19, 21 mm (L=76 mm); 1/4" (6.3 mm): 6, 7, 8, 9, 10, 11, 12, 13 (L=50 mm); CrV 50BV30: 1/2" (12.7 mm): E10, E11, E12, E14, E16, 1/4" (6.3 mm): E4, E5, E6, E7, E8; CrV 50BV30: 1/2" (12.7 mm): (127, 254 mm); 1/4" (6.3 mm): (50.8, 101.6 mm); CrV 50BV30: 1/2" (12.7 mm): CrV 50BV30: 1/2" (12.7 mm): 16, 21 mm; CrV 50BV30: 1/2" (12.7 mm): (255 mm); 1/4" (6.3 mm): (152.4 mm); CrV 50BV30: 1/2" (12.7 mm): (255 mm); 1/4" (6.3 mm): (155 mm); CrV 6140: 1/4" (6.3 mm): (150 mm); CrV 50BV30: 1/4" (6.3 mm): 4, 5.5, 6.5 mm; AISI S2 / CrV 6150: 1/4" (6.3 mm): PH1 (x2), PH2 (x2), PH3; AISI S2 / CrV 6150: 1/4" (6.3 mm): PZ1, PZ2, PZ3; AISI S2 / CrV 6150: 1/4" (6.3 mm): T8, T10, T15, T20, T25, T30, T40; AISI S2 / CrV 6150: 1/4" (6.3 mm): 3, 4, 5, 6, 7, 8 mm; AISI S2 / CrV 6150

**DRAWER / SZUFLADA 2**

200 mm; CrV: Ø 3-6 mm (L=52 mm), Ø 6-8 (L=58 mm), Ø 8-11 (L=66 mm), Ø 11-14 (L=75 mm), Ø 14-18 (L=80 mm), Ø 18-25 (L=88 mm); 8, 9, 10, 11, 12, 13, 14, 15, 16, 17, 18, 19, 21, 22, 24 mm; CrV: T10, T15, T20, T25, T27, T30, T40, T45, T50; CrV 6150: 2, 2.5, 3, 4, 5, 6, 7, 8, 10, 12 mm; CrV 6150

**DRAWER / SZUFLADA 3**

6.0x38, 2.0x75, 3.0x75, 4.0x100, 5.0x100, 6.0x100 mm; PH0x100, PH1x100, PH2x38, PH2x150, PH3x150 mm; T7x75, T8x75, T9x75, T10x100, T15x100, T20x100, T25x100, T27x100 mm; S2; 6.0x150 mm; PH2x150 mm; CrV 6150

**DRAWER / SZUFLADA 4**

180 mm; 160 mm; 200 mm; 250 mm; 400g; 340g; 12.5x152, 16.0x172 mm; CrV 6150; 3.0x150, 4.0x150, 5.0x150, 6.0x150, 8.0x150 mm; CrV 6150; 8.0x112 mm; CrV 6150

**DRAWER / SZUFLADA 5**

M3x0.5 (x3), M4x0.7 (x3), M5x0.8 (x3), M6x1.0 (x3), M7x1.0 (x3), M8x1.25 (x3), M10x1.5 (x3), M12x1.75 (x3); HSS M2; M3, M4x0.7, M5x0.8, M6x1.0, M7x1.0, M8x1.25, M10x1.5, M12x1.75; HSS M2; M7-M9; M3-M12; #2, 200 mm; #2, 200 mm; #2, 200 mm; LED; 3 m x 16 mm; 300 mm; 0-150 mm

**DRAWER / SZUFLADA 1**

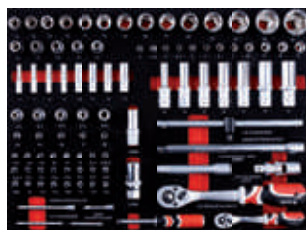

**DRAWER / SZUFLADA 2**

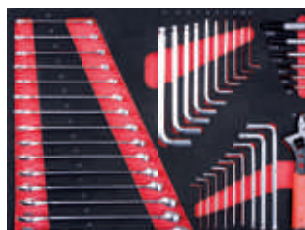

**DRAWER / SZUFLADA 3**



**DRAWER / SZUFLADA 4**



**DRAWER / SZUFLADA 5**

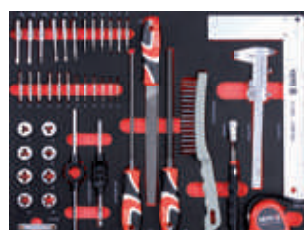

|             |                    |   |
|-------------|--------------------|---|
| <b>YATO</b> | drawers / szuflady |   |
| YT-55290    | 7                  | 1 |



**CREATE YOUR WORKPLACE - STWÓRZ SWOJE MIEJSCE PRACY**

YT-09061



YT-09951



YT-09952



YT-08922



YT-08921

YT-08920



- GB Tool chest
- D Werkzeugkasten
- PL Szafka warsztatowa
- RUS Портативный ящик для инструментов
- CZ Přenosná skříňka na nářadí
- H Hordozható szerszámós láda
- RO Cutie pt. instrumente portabile
- F Servante d'atelier
- I Banco da lavoro armadio
- E Cajonera portátil
- CN 駝檢箱



WHITE  
CARTON BOX  
& COLOR LABEL



690x465  
x400 mm

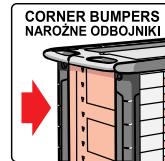

| YATO     | drawers / szuflady |   |
|----------|--------------------|---|
| YT-09151 | 3                  | 1 |

- GB Tool chest
- D Werkzeugkasten
- PL Szafka warsztatowa
- RUS Портативный ящик для инструментов
- CZ Přenosná skříňka na nářadí
- H Hordozható szerszámós láda
- RO Cutie pt. instrumente portabile
- F Servante d'atelier
- I Banco da lavoro armadio
- E Cajonera portátil
- CN 駝檢箱



WHITE  
CARTON BOX  
& COLOR LABEL



690x465  
x400 mm

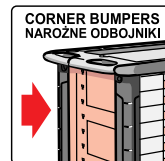

| YATO     | drawers / szuflady |   |
|----------|--------------------|---|
| YT-09152 | 4                  | 1 |

- GB Tool chest
- D Werkzeugkasten
- PL Szafka warsztatowa
- RUS Портативный ящик для инструментов
- CZ Přenosná skříňka na nářadí
- H Hordozható szerszámós láda
- RO Cutie pt. instrumente portabile
- F Servante d'atelier
- I Banco da lavoro armadio
- E Cajonera portátil
- CN 駝檢箱



WHITE  
CARTON BOX  
& COLOR LABEL



690x465  
x535 mm

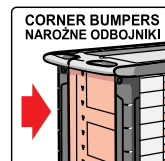

| YATO     | drawers / szuflady |   |
|----------|--------------------|---|
| YT-09155 | 6                  | 1 |



- GB Roller cabinet
- D Werkstattrollwagen
- PL Szafka serwisowa
- RUS Инструментальный кабинет
- CZ Dílenská skříňka
- H Görgös szerszámátároló
- RO Dulap de scule
- F Servante d'atelier
- I Armadio per utensili
- E Armario en ruedas
- CN 工具车



|   |  |                                    |                            |
|---|--|------------------------------------|----------------------------|
| 1130x570<br>x1000 mm  | 6x                                       | BALL BEARING<br>ŁOŻYSKA<br>KULKOWE | 25kg<br>35kg<br>35kg       |
| OIL PROOF<br>STEEL<br>WORKTOP<br>OLEJODOPORNY<br>STALOWY BLAT | DRAWERS<br>LOCKING<br>BLOKADA<br>SZUFLAD | WHEELS<br>KÓŁKA                    | WHEEL Ø<br>KÓŁKA 160<br>mm |
| UNIVERSAL PERFORATION<br>UNIWERSALNA<br>PERFORACJA            | 2x T                                     | 2x BRAKE<br>HAMULCE                |                            |
| DOUBLE WALLS<br>PODWÓJNE<br>SCIANY                            | CORNER BUMPERS<br>NARÓŻNE ODBOJNIKI      |                                    |                            |

WHITE  
CARTON BOX  
& COLOR LABEL



|             |                    |   |
|-------------|--------------------|---|
| <b>YATO</b> | drawers / szuflady | 1 |
| YT-09001    | 6                  | 1 |

- GB Roller cabinet
- D Werkstattrollwagen
- PL Szafka serwisowa
- RUS Инструментальный кабинет
- CZ Dílenská skříňka
- H Görgös szerszámátároló
- RO Dulap de scule
- F Servante d'atelier
- I Armadio per utensili
- E Armario en ruedas
- CN 工具车



|   |  |                                    |                            |
|---|--|------------------------------------|----------------------------|
| 1130x570<br>x1000 mm  | 6+1                                      | BALL BEARING<br>ŁOŻYSKA<br>KULKOWE | 25kg<br>35kg<br>35kg       |
| OIL PROOF<br>STEEL<br>WORKTOP<br>OLEJODOPORNY<br>STALOWY BLAT | DRAWERS<br>LOCKING<br>BLOKADA<br>SZUFLAD | WHEELS<br>KÓŁKA                    | WHEEL Ø<br>KÓŁKA 160<br>mm |
| UNIVERSAL PERFORATION<br>UNIWERSALNA<br>PERFORACJA            | 2x T                                     | 2x BRAKE<br>HAMULCE                |                            |
| DOUBLE WALLS<br>PODWÓJNE<br>SCIANY                            | CORNER BUMPERS<br>NARÓŻNE ODBOJNIKI      |                                    |                            |

WHITE  
CARTON BOX  
& COLOR LABEL



|             |                    |   |
|-------------|--------------------|---|
| <b>YATO</b> | drawers / szuflady | 1 |
| YT-09002    | 6+1                | 1 |

- GB Roller cabinet
- D Werkstattrollwagen
- PL Szafka serwisowa
- RUS Инструментальный кабинет
- CZ Dílenská skříňka
- H Görgös szerszámátároló
- RO Dulap de scule
- F Servante d'atelier
- I Armadio per utensili
- E Armario en ruedas
- CN 工具车



|   |  |                                    |                            |
|---|--|------------------------------------|----------------------------|
| 1130x570<br>x1000 mm  | 12x                                      | BALL BEARING<br>ŁOŻYSKA<br>KULKOWE | 25kg<br>35kg<br>35kg       |
| OIL PROOF<br>STEEL<br>WORKTOP<br>OLEJODOPORNY<br>STALOWY BLAT | DRAWERS<br>LOCKING<br>BLOKADA<br>SZUFLAD | WHEELS<br>KÓŁKA                    | WHEEL Ø<br>KÓŁKA 160<br>mm |
| UNIVERSAL PERFORATION<br>UNIWERSALNA<br>PERFORACJA            | 2x T                                     | 2x BRAKE<br>HAMULCE                |                            |
| DOUBLE WALLS<br>PODWÓJNE<br>SCIANY                            | CORNER BUMPERS<br>NARÓŻNE ODBOJNIKI      |                                    |                            |

WHITE  
CARTON BOX  
& COLOR LABEL



|             |                    |   |
|-------------|--------------------|---|
| <b>YATO</b> | drawers / szuflady | 1 |
| YT-09003    | 12                 | 1 |



GB Roller cabinet  
 D Werkstattrollwagen  
 PL Szafka serwisowa  
 RUS Инструментальный кабинет  
 CZ Dilenská skříňka  
 H Görgös szerszámátároló  
 RO Dulap de scule  
 F Servante d'atelier  
 I Armadio per utensili  
 E Armario en ruedas  
 CN 工具车

995x680 x458mm  
 4x  
 DRAWERS LOCKING BLOKADA SZUFLAD  
 CENTRAL LOCK CENTRALNY ZAMEK  
 300kg max.  
 BALL BEARING ŁOŻYSKA KULKOWE  
 WHEELS TŹŁYKA  
 WHEEL Ø 127 mm  
 NON SLIP POLYPROPYLENE WORKTOP ANTYPOŚLIZGOWY POLIPROPYLENOWY BLAT  
 4x  
 2x BRAKE HAMULCE



|             |                    |   |
|-------------|--------------------|---|
| <b>YATO</b> | drawers / szuflady | 1 |
| YT-0912     | 4                  | 1 |

GB Roller cabinet  
 D Werkstattrollwagen  
 PL Szafka serwisowa  
 RUS Инструментальный кабинет  
 CZ Dilenská skříňka  
 H Görgös szerszámátároló  
 RO Dulap de scule  
 F Servante d'atelier  
 I Armadio per utensili  
 E Armario en ruedas  
 CN 工具车

995x680 x458mm  
 6x  
 DRAWERS LOCKING BLOKADA SZUFLAD  
 CENTRAL LOCK CENTRALNY ZAMEK  
 300kg max.  
 BALL BEARING ŁOŻYSKA KULKOWE  
 WHEELS TŹŁYKA  
 WHEEL Ø 127 mm  
 NON SLIP POLYPROPYLENE WORKTOP ANTYPOŚLIZGOWY POLIPROPYLENOWY BLAT  
 2x  
 2x BRAKE HAMULCE



|             |                    |   |
|-------------|--------------------|---|
| <b>YATO</b> | drawers / szuflady | 1 |
| YT-0913     | 6                  | 1 |

GB Roller cabinet  
 D Werkstattrollwagen  
 PL Szafka serwisowa  
 RUS Инструментальный кабинет  
 CZ Dilenská skříňka  
 H Görgös szerszámátároló  
 RO Dulap de scule  
 F Servante d'atelier  
 I Armadio per utensili  
 E Armario en ruedas  
 CN 工具车

995x680 x458mm  
 7x  
 DRAWERS LOCKING BLOKADA SZUFLAD  
 CENTRAL LOCK CENTRALNY ZAMEK  
 NON SLIP POLYPROPYLENE WORKTOP ANTYPOŚLIZGOWY POLIPROPYLENOWY BLAT  
 300kg max.  
 BALL BEARING ŁOŻYSKA KULKOWE  
 WHEELS TŹŁYKA  
 WHEEL Ø 127 mm  
 2x BRAKE HAMULCE  
 2x



|             |                    |   |
|-------------|--------------------|---|
| <b>YATO</b> | drawers / szuflady | 1 |
| YT-0914     | 7                  | 1 |

GB Roller cabinet  
 D Werkstattrollwagen  
 PL Szafka serwisowa  
 RUS Инструментальный кабинет  
 CZ Dilenská skříňka  
 H Görgös szerszámátároló  
 RO Dulap de scule  
 F Servante d'atelier  
 I Armadio per utensili  
 E Armario en ruedas  
 CN 工具车

958x766 x465mm  
 DRAWERS LOCKING BLOKADA SZUFLAD  
 NON SLIP POLYPROPYLENE WORKTOP ANTYPOŚLIZGOWY POLIPROPYLENOWY BLAT  
 BALL BEARING ŁOŻYSKA KULKOWE  
 WHEELS TŹŁYKA  
 UNIVERSAL PERFORATION UNIERSALNA PERFORACJA  
 DOUBLE WALLS PODWÓJNE ŚCIANY  
 CORNER BUMPERS NAROŻNE ODBOJNIKI



|             |                    |   |
|-------------|--------------------|---|
| <b>YATO</b> | drawers / szuflady | 1 |
| YT-0902     | 6                  | 1 |
| YT-0903     | 7                  | 1 |



GB Roller cabinet  
D Werkstattrollwagen  
PL Szafka serwisowa  
RUS Инструментальный кабинет  
CZ Dilenská skříňka  
H Görgös szerszámátároló  
RO Dulap de scule  
F Servante d'atelier  
I Armadio per utensili  
E Armario en ruedas  
CN 工具车



WHITE  
CARTON BOX  
& COLOR LABEL

|             |                    |   |
|-------------|--------------------|---|
| <b>YATO</b> | drawers / szuflady | 1 |
| YT-0904     | 7                  | 1 |

GB Roller cabinet  
D Werkstattrollwagen  
PL Szafka serwisowa  
RUS Инструментальный кабинет  
CZ Dilenská skříňka  
H Görgös szerszámátároló  
RO Dulap de scule  
F Servante d'atelier  
I Armadio per utensili  
E Armario en ruedas  
CN 工具车

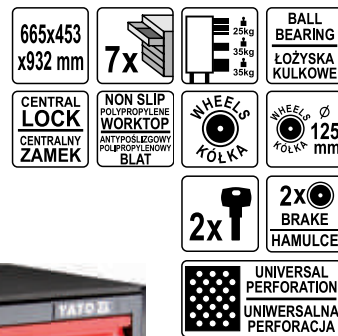

WHITE  
CARTON BOX  
& COLOR LABEL

|             |                    |   |
|-------------|--------------------|---|
| <b>YATO</b> | drawers / szuflady | 1 |
| YT-09000    | 7                  | 1 |

GB Roller cabinet  
D Werkstattrollwagen  
PL Szafka serwisowa  
RUS Инструментальный кабинет  
CZ Dilenská skříňka  
H Görgös szerszámátároló  
RO Dulap de scule  
F Servante d'atelier  
I Armadio per utensili  
E Armario en ruedas  
CN 工具车



WHITE  
CARTON BOX  
& COLOR LABEL

|             |                    |   |
|-------------|--------------------|---|
| <b>YATO</b> | drawers / szuflady | 1 |
| YT-09031    | 7                  | 1 |

GB Roller cabinet  
D Werkstattrollwagen  
PL Szafka serwisowa  
RUS Инструментальный кабинет  
CZ Dilenská skříňka  
H Görgös szerszámátároló  
RO Dulap de scule  
F Servante d'atelier  
I Armadio per utensili  
E Armario en ruedas  
CN 工具车

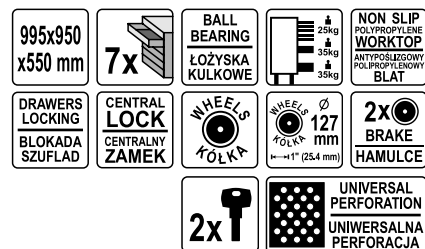

WHITE  
CARTON BOX  
& COLOR LABEL

|             |                    |   |
|-------------|--------------------|---|
| <b>YATO</b> | drawers / szuflady | 1 |
| YT-09008    | 7                  | 1 |



- GB Shutter cabinet
- D Werkstatt Hängeschrank
- PL Szafka wisząca
- RUS Шкафчик для инструмента настенный
- CZ Zavěsná skříňka
- H Szerszámtároló
- RO Raft de scule
- F Placard d'atelier
- I Scaffale
- E Armario colgante
- CN 橙整架



1375x714  
x145 mm

**CENTRAL LOCK**  
CENTRALNY ZAMEK

**UNIVERSAL PERFORMANCE**  
UNIWEERSALNA PERFORACJA

WHITE  
CARTON BOX  
& COLOR LABEL



| YATO     | size / rozmiar (mm) |   |
|----------|---------------------|---|
| YT-09061 | 1375x714x145        | 1 |

- GB Workbench
- D Werkbank
- PL Stół warsztatowy
- RUS Верстак
- CZ Pracovní stůl
- H Munkapad
- RO Banc de lucru
- F Table d'atelier
- I Banco da lavoro
- E Banco de trabajo
- CN 工作台



1500x780  
x830 mm

**NON SLIP ABS WORKTOP**  
ANTYPOŚLIZGOWY BLAT Z TWORZYWA ABS

WHITE  
CARTON BOX  
& COLOR LABEL



| YATO     | size / rozmiar (mm) |   |
|----------|---------------------|---|
| YT-08920 | 1500x780x830        | 1 |

- GB Drawer insert / Combination spanners
- D Schubladeneinlage / Schrauben- und Ringschlüssel
- PL Wkład do szuflady / Klucze płasko-oczkowe
- RUS Вклад к выдвигному ящику / Плоско-закрытый накладной ключ
- CZ Vložka do zásuvky / Klíče ploché-očkové
- H Fiókbetét / Kombinált kulcsok
- RO Adaos la sertar / Chei plane - inelare
- F Module plastique pour servante avec clés mixtes
- I Tenone per l'armadio chiavi
- E Accesorio de cajón / Llave española de muletilla
- CN 两用扳手托盘组套

PLASTIC TRAY & COLOR LABEL



CrV



6  
PCS

22, 24, 27, 28, 30, 32 mm; CrV

| YATO    |   |
|---------|---|
| YT-5532 | 4 |

- GB Drawer insert / Bi-hexagonal ring spanner
- D Schubladeneinlage / Doppelringschlüssel
- PL Wkład do szuflady / Klucze oczkowe odgięte
- RUS Вклад к выдвигному ящику / Ключ накидной изогнутый
- CZ Vložka do zásuvky / Klíče očkové ohnuté
- H Fiókbetét / Hajlítotszárú csillagkulcs
- RO Adaos la sertar / Chei inelaro-curbată
- F Module plastique pour servante clés contre-coudées
- I Tenone per l'armadio chiavi
- E Accesorio de cajón / Llave de estrella
- CN 双头高颈梅花扳手托盘组套

PLASTIC TRAY & COLOR LABEL



CrV



4  
PCS

21x23, 24x27, 25x28, 30x32 mm; CrV

| YATO    |   |
|---------|---|
| YT-5543 | 8 |

16  
PCS

6, 7, 8, 9, 10, 11, 12, 13, 14, 15, 16, 17, 18, 19, 20, 21 mm; CrV

| YATO    |   |
|---------|---|
| YT-5531 | 8 |

7  
PCS

6x7, 8x9, 10x11, 12x13, 14x15, 16x17, 18x19 mm; CrV

| YATO    |   |
|---------|---|
| YT-5533 | 8 |



- GB Drawer insert / L-type socket wrench  
D Schubladeneinlage / Steckschlüssel gebogen  
PL Wkład do szuflady / Klucz nasadowy typ „L”  
RUS Вклад к выдвижному ящику / Ключ торцевой L-типа  
CZ Vložka do zásuvky / Nástrčný klíč fajfkový  
H Fiókbetét / Kulcs, dugó-pipa  
RO Adaos la sertar / Cheie tubulara cu cot tip „L”  
F Module plastique pour servante / Clé a douille de type „L”  
I Tenone per l'armadio / Chiave a tubo tipo „L”  
E Accesorio de cajón / Llave de vaso „L”  
CN L型套筒扳手托盘组套



10  
PCS

CrV



7, 8, 9, 10, 11, 12, 13, 14, 17, 19 mm



- GB Drawer insert / Pliers  
D Schubladeneinlage / Zangen  
PL Wkład do szuflady / Szczypce  
RUS Вклад к выдвижному ящику / Клещи  
CZ Vložka do zásuvky / Kleště  
H Fiókbetét / Fogók  
RO Adaos la sertar / Clește  
F Module plastique pour servante avec pinces  
I Tenone per l'armadio / Pinze  
E Accesorio de cajón / Pinzas  
CN 钳子托盘组套



4  
PCS

CrV

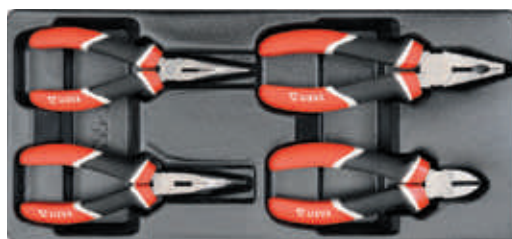

180 mm; 160 mm LONG NOSE;  
160 mm; 160 mm BENT NOSE



- GB Drawer insert / Pliers  
D Schubladeneinlage / Zangen  
PL Wkład do szuflady / Szczypce  
RUS Вклад к выдвижному ящику / Клещи  
CZ Vložka do zásuvky / Kleště  
H Fiókbetét / Fogók  
RO Adaos la sertar / Clește  
F Module plastique pour servante avec pinces  
I Tenone per l'armadio / Pinze  
E Accesorio de cajón / Pinzas  
CN 挡圈钳托盘组套



4  
PCS

CrV

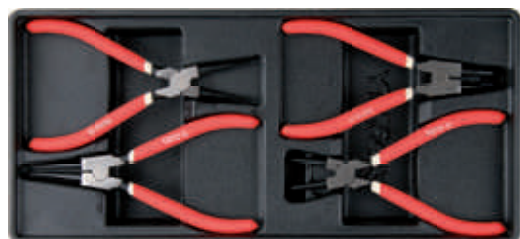

180 mm EXTERNAL STRAIGHT; 180 mm INTERNAL STRAIGHT;  
180 mm EXTERNAL BENT; 180 mm INTERNAL BENT



- GB Drawer insert / Pliers  
D Schubladeneinlage / Zangen  
PL Wkład do szuflady / Szczypce  
RUS Вклад к выдвижному ящику / Клещи  
CZ Vložka do zásuvky / Kleště  
H Fiókbetét / Fogók  
RO Adaos la sertar / Clește  
F Module plastique pour servante avec pinces  
I Tenone per l'armadio / Pinze  
E Accesorio de cajón / Pinzas  
CN 钳子托盘组套

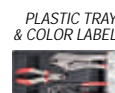

3  
PCS

CrMo

CrV



180 mm; 250 mm; 250 mm



- GB Drawer insert / Pliers  
D Schubladeneinlage / Zangen  
PL Wkład do szuflady / Szczypce  
RUS Вклад к выдвижному ящику / Клещи  
CZ Vložka do zásuvky / Kleště  
H Fiókbetét / Fogók  
RO Adaos la sertar / Clește  
F Module plastique pour servante avec pinces  
I Tenone per l'armadio / Pinze  
E Accesorio de cajón / Pinzas  
CN 钳子托盘组套



3  
PCS

CrMo

CrV



180 mm; 250 mm; 280 mm



- GB Drawer insert / Pliers  
D Schubladeneinlage / Zangen  
PL Wkład do szuflady / Szczypce  
RUS Вклад к выдвижному ящику / Клещи  
CZ Vložka do zásuvky / Kleště  
H Fiókbetét / Fogók  
RO Adaos la sertar / Clește  
F Module plastique pour servante avec pinces  
I Tenone per l'armadio / Pinze  
E Accesorio de cajón / Pinzas  
CN 钳子托盘组套



3  
PCS

CrMo

CrV



250 mm; 125 mm; 300 mm





GB Drawer insert / Pliers and adjustable wrenches  
 D Schubladeneinlage / Zangen und rollgabelschlüssel  
 PL Wkład do szuflady / Szczypce i klucze nastawne  
 RUS Вклад к выдвижному ящику / Клещи и ключ разводной  
 CZ Vložka do zásuvky / Kleště, nastavitelný klíč  
 H Fiókbetét / Fogók és állítható svédkulcs  
 RO Adaos la sertar / Clește și cheie reglabilă  
 F Module plastique pour servante / Pincés et clé a molette  
 I Tenone per l'armadio / Pinze  
 E Accesorio de cajón / Pinzas y llave ajustable  
 CN 活络扳手大力钳托盘组套

PLASTIC TRAY & COLOR LABEL



4 PCS

CrMo

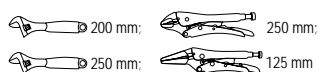

YATO  
 YT-55444 8

GB Drawer insert / Pliers  
 D Schubladeneinlage / Zangen  
 PL Wkład do szuflady / Szczypce  
 RUS Вклад к выдвижному ящику / Клещи  
 CZ Vložka do zásuvky / Kleště  
 H Fiókbetét / Fogók  
 RO Adaos la sertar / Clește  
 F Module plastique pour servante avec pincés  
 I Tenone per l'armadio / Pinze  
 E Accesorio de cajón / Pinzas  
 CN 钳子托盘组套

PLASTIC TRAY & COLOR LABEL



4 PCS

CrV

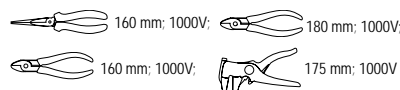

YATO  
 YT-55464 8

GB Drawer insert / Slotted screwdrivers  
 D Schubladeneinlage / Flachschauber  
 PL Wkład do szuflady / Wkrętki płaskie  
 RUS Вклад к выдвижному ящику / Плоские отвертки  
 CZ Vložka do zásuvky / Šroubováky ploché  
 H Fiókbetét / Lapos csavarhúzó  
 RO Adaos la sertar / Șurubelnițe plane  
 F Module plastique pour servante avec trounevis  
 I Tenone per l'armadio / Set di cacciaviti piatti  
 E Accesorio de cajón / Desarmadores planos  
 CN 一字螺丝批托盘组套

PLASTIC TRAY & COLOR LABEL

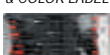

7 PCS

CrMo

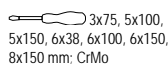
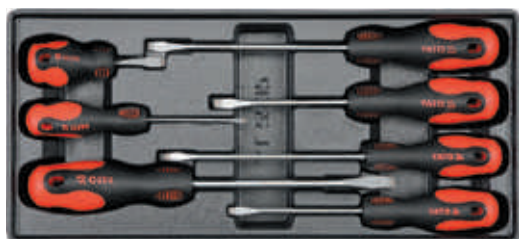

YATO  
 YT-5535 8

GB Drawer insert / Phillips screwdrivers  
 D Schubladeneinlage / Kreuzschlitzschrauber  
 PL Wkład do szuflady / Wkrętki krzyżakowe  
 RUS Вклад к выдвижному ящику / Крестовидные отвертки  
 CZ Vložka do zásuvky / Šroubováky křížové  
 H Fiókbetét / Kereszt csavarhúzó  
 RO Adaos la sertar / Șurubelnițe în cruce  
 F Module plastique pour servante avec trounevis  
 I Tenone per l'armadio / Set di cacciaviti a croce  
 E Accesorio de cajón / Desarmadores de cruz  
 CN 十字螺丝批托盘组套

PLASTIC TRAY & COLOR LABEL



7 PCS

CrMo

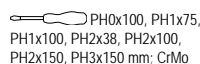

YATO  
 YT-5536 8

16

GB Drawer insert / Screwdriver set  
 D Schubladeneinlage / Schraubendrehersatz  
 PL Wkład do szuflady / Komplet wkrętków  
 RUS Вклад к выдвижному ящику / Набор отверток  
 CZ Vložka do zásuvky / Zámečnické šroubováky  
 H Fiókbetét / Lakatos csavarhúzó  
 RO Adaos la sertar / Șurubelnițe de lăcătușerie  
 F Module plastique pour servante avec trounevis  
 I Tenone per l'armadio / Set di cacciaviti  
 E Accesorio de cajón / Juego de destornilladores  
 CN 螺丝批托盘组套

PLASTIC TRAY & COLOR LABEL



13 PCS

S2

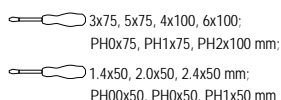

YATO  
 YT-55455 8

GB Drawer insert / Go-through screwdrivers  
 D Schubladeneinlage / Schlagschrauber  
 PL Wkład do szuflady / Wkrętki do pobijania  
 RUS Вклад к выдвижному ящику / Отвертка-било  
 CZ Vložka do zásuvky / Šroubovák s úderným koncem  
 H Fiókbetét / Beütő csavarhúzó  
 RO Adaos la sertar / Șurubelniță pt. fixare  
 F Module plastique pour servante / Allez - par tournevis  
 I Tenone per l'armadio / Set di cacciaviti  
 E Accesorio de cajón / Destornillador para dar golpes  
 CN 穿心螺丝批托盘组套

PLASTIC TRAY & COLOR LABEL



4 PCS

CrV



YATO  
 YT-55469 8



- GB** Drawer insert / Screwdriver set  
**D** Schubladeneinlage / Schraubendrehersatz  
**PL** Wkład do szuflady / Komplet wkrętek  
**RUS** Вклад к выдвижному ящику / Набор отвёрток  
**CZ** Vložka do zásuvky / Zámečnické šroubováky  
**H** Fiókbetét / Lakatos csavarhúzó  
**RO** Adaos la sertar / Şurubelnițe de lăcătuşerie  
**F** Module plastique pour servante avec trounevis  
**I** Tenone per l'armadio / Set di cacciaviti  
**E** Accesorio de cajón / Juego de destornilladores  
**CN** 绝缘螺丝批托盘组套

PLASTIC TRAY & COLOR LABEL



8  
PCS

S2



- 3x75, 4x100, 5.5x125, 6.5x150,  
PH1x80, PH2x100, PH3x150 mm; 1000V;  
4x190 mm; 250V

YATO

YT-55462



8

- GB** Drawer insert / Tool set  
**D** Schubladeneinlage / Sechskant-Steckschlüssel-Satz  
**PL** Wkład do szuflady / Zestaw narzędziowy  
**RUS** Вклад к выдвижному ящику / Набор инструмента  
**CZ** Vložka do zásuvky / Sada nástrčných kľúčů a ráčny  
**H** Fiókbetét / Dugókulcs készlet racsni hajtókarral  
**RO** Adaos la sertar / Rotrusa chei tubulare cu antrenor  
**F** Module plastique pour servante / Coffret d'outillage  
**I** Tenone per l'armadio / Set di utensili  
**E** Accesorio de cajón / Juego de herramientas  
**CN** 套筒扳手组套

PLASTIC TRAY & COLOR LABEL



4  
PCS

CrV



- 3/4" (19.0 mm); (200 mm); CrV 6140;  
3/4" (19.0 mm); CrV 50BV30;  
3/4" (19.0 mm); (500 mm); 72T; CrV 6140;  
3/4" (19.0 mm); (500 mm); CrV 50BV30

YATO

YT-55458



4

- GB** Drawer insert / Socket set  
**D** Schubladeneinlage / Steckschlüsselsatz  
**PL** Wkład do szuflady / Zestaw kluczy nasadowych  
**RUS** Вклад к выдвижному ящику / Торцовые ключи  
**CZ** Vložka do zásuvky / Kľíče nástrčné  
**H** Fiókbetét / Dugókulcsok  
**RO** Adaos la sertar / Duză cheie  
**F** Module plastique pour servante avec set d'outillages  
**I** Tenone per l'armadio chiave a bussola  
**E** Accesorio de cajón / Llaves de cubo  
**CN** 套筒托盘组套

PLASTIC TRAY & COLOR LABEL



22  
PCS

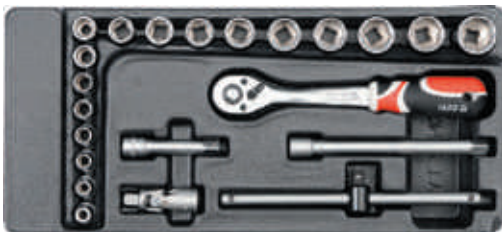

- 3/8" (9.5 mm): 6, 7, 8, 9, 10, 11, 12, 13, 14,  
15, 16, 17, 18, 19, 20, 21, 22 mm; CrV 50BV30;  
3/8" (9.5 mm); (76, 152.4 mm); CrV 50BV30;  
3/8" (9.5 mm); CrV 50BV30;  
3/8" (9.5 mm); (200 mm); 72T; CrV 6140;  
3/8" (9.5 mm); (198 mm); CrV 50BV30

YATO

YT-5542



8

- GB** Drawer insert / Socket set  
**D** Schubladeneinlage / Steckschlüsselsatz  
**PL** Wkład do szuflady / Zestaw kluczy nasadowych  
**RUS** Вклад к выдвижному ящику / Торцовые ключи  
**CZ** Vložka do zásuvky / Kľíče nástrčné  
**H** Fiókbetét / Dugókulcsok  
**RO** Adaos la sertar / Duză cheie  
**F** Module plastique pour servante avec set d'outillages  
**I** Tenone per l'armadio chiave a bussola  
**E** Accesorio de cajón / Llaves de cubo  
**CN** 套筒托盘组套

PLASTIC TRAY & COLOR LABEL



25  
PCS

- 1/4" (6.3 mm): 3.5, 4, 4.5, 5, 5.5, 6, 7, 8, 9, 10, 11, 12, 13, 14 mm; CrV 50BV30;  
1/4" (6.3 mm): 8, 10, 11, 12, 13 mm; CrV 50BV30;  
1/4" (6.3 mm); (50.8, 101.6 mm); CrV 6140;  
1/4" (6.3 mm); CrV 50BV30;  
1/4" (6.3 mm); (155 mm); 72T; CrV 6140;  
1/4" (6.3 mm); (152.4 mm); CrV 50BV30

YATO

YT-5541



8

- GB** Drawer insert / Socket set  
**D** Schubladeneinlage / Steckschlüsselsatz  
**PL** Wkład do szuflady / Zestaw kluczy nasadowych  
**RUS** Вклад к выдвижному ящику / Торцовые ключи  
**CZ** Vložka do zásuvky / Kľíče nástrčné  
**H** Fiókbetét / Dugókulcsok  
**RO** Adaos la sertar / Duză cheie  
**F** Module plastique pour servante avec set d'outillages  
**I** Tenone per l'armadio chiave a bussola  
**E** Accesorio de cajón / Llaves de cubo  
**CN** 套筒托盘组套

PLASTIC TRAY & COLOR LABEL



24  
PCS



- 1/2" (12.7 mm): 10, 11, 12, 13, 14, 15, 16,  
17, 18, 19, 20, 21, 22, 23, 24,  
27, 30, 32 mm; CrV 50BV30;  
1/2" (12.7 mm); (127 mm); CrV 50BV30;  
1/2" (12.7 mm); CrV 50BV30;  
1/2" (12.7 mm); (255 mm); 72T; CrV 6140;  
1/2" (12.7 mm); (255 mm); CrV 50BV30;  
1/2" (12.7 mm); 16; 21 mm; CrV 50BV30

YATO

YT-5537



4

- GB** Drawer insert / Screwdriver bits  
**D** Schubladeneinlage / Endstücke für Schraubenzieher  
**PL** Wkład do szuflady / Końcówki śrubokrętowe  
**RUS** Вклад к выдвижному ящику / Насадки для отвёрток  
**CZ** Vložka do zásuvky / Šroubovací nástavce  
**H** Fiókbetét / Csavarhúzó bitek  
**RO** Adaos la sertar / Terminații pt. şurubelnițe  
**F** Module plastique pour servante avec set d'embouts  
**I** Tenone per l'armadio chiave punti di avvitamento  
**E** Accesorio de cajón / Puntas para desarmadores  
**CN** 旋具头托盘组套

PLASTIC TRAY & COLOR LABEL



40  
PCS

- H4, H5, H6, H7, H8, H10, H12 (L=30 mm); H4, H5, H6, H7, H8, H10, H12 (L=75 mm); AISI S2; M5, M6, M7, M10, M12 (L=30 mm); M5, M6, M7, M10, M12 (L=75 mm); AISI S2; T20, T25, T30, T40, T45, T50, T55 (L=30 mm); T20, T25, T30, T40, T45, T50, T55 (L=75 mm); AISI S2; 1/2" (12.7 mm), 3/8" (9.5 mm)

YATO

YT-5538



8



- GB** Drawer insert / Socket set  
**D** Schubladeneinlage / Steckschlüsselsatz  
**PL** Wkład do szuflady / Zestaw kluczy nasadowych  
**RUS** Вклад к выдвижному ящику / Торцовые ключи  
**CZ** Vložka do zásuvky / Klíče nástrčné  
**H** Fiókbetét / Dugókulcsok  
**RO** Adaos la sertar / Duză cheie  
**F** Module plastique pour servante avec set d'outillages  
**I** Tenone per l'armadio chiave a bussola  
**E** Accesorio de cajón / Llaves de cubo  
**CN** 套筒托盘组套



14  
PCS

CrV  
50BV30



3/4" (19.0 mm): 19, 21, 22, 24, 27, 28, 30, 32, 34, 36, 41, 46, 50, 55 mm



- GB** Drawer insert / Deep sockets  
**D** Schubladeneinlage / Tiefe Steckschlüssel  
**PL** Wkład do szuflady / Klucze nasadowe długie  
**RUS** Вклад к выдвижному ящику / Торцовые глубокие ключи  
**CZ** Vložka do zásuvky / Klíče nástrčné hluboké  
**H** Fiókbetét / Mély dugókulcsok  
**RO** Adaos la sertar / Prize de curent adânci  
**F** Module plastique pour servante avec set de douilles  
**I** Tenone per l'armadio chiave a bussola lunghe  
**E** Accesorio de cajón / Llaves de cubo profundo  
**CN** 六角长套筒托盘组套



14  
PCS

CrV  
50BV30



1/2" (12.7 mm): 8, 9, 10, 11, 12, 13, 14, 15, 16, 17, 18, 19, 20, 21 mm (L=76 mm); CrV 50BV30

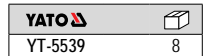

- GB** Drawer insert / Tool set  
**D** Schubladeneinlage / Sechskant-Steckschlüssel-Satz  
**PL** Wkład do szuflady / Zestaw narzędziowy  
**RUS** Вклад к выдвижному ящику / Набор инструмента  
**CZ** Vložka do zásuvky / Sada nástrčných klíčů a ráčny  
**H** Fiókbetét / Dugókulcs készlet racsni hajtókarral  
**RO** Adaos la sertar / Rotrusa chei tubulare cu antrenor  
**F** Module plastique pour servante / Coffret d'outillage  
**I** Tenone per l'armadio / Set di utensili  
**E** Accesorio de cajón / Juego de herramientas  
**CN** 套筒扳手组套



31  
PCS

CrV

S2



1/2" (12.7 mm): E10, E12, E14, E16, E18, E20 (L=38 mm); CrV 50BV30;  
 M5, M6, M7, M10, M12 (L=30 mm); AISI S2;  
 1/2" (12.7 mm): 10 mm; CrV 6150;  
 2, 2.5, 3, 4, 5, 6, 7, 8, 10, 12 mm; CrV 6150;  
 T10, T15, T20, T25, T27, T30, T40, T45, T50; CrV 6150



- GB** Drawer insert / Hammers and chisels  
**D** Schubladeneinlage / Hämmer und Meißel  
**PL** Wkład do szuflady / Młotki i przecinaki  
**RUS** Вклад к выдвижному ящику / Молотки и зубила  
**CZ** Vložka do zásuvky / Kladiva, dláta a sekáče  
**H** Fiókbetét / Kalapácsok és hidegvágók  
**RO** Adaos la sertar / Ciocane și dălți  
**F** Module plastique pour servante avec marteaux et burins  
**I** Tenone per l'armadio martelli e scalpelli  
**E** Accesorio de cajón / Martillos y cinceles  
**CN** 锤头凿子托盘组套



5  
PCS

CrV



300 g (L=300 mm);  
 40 mm (L=350 mm);  
 10x8x142 mm,  
 12x10x152 mm, 16x13x172 mm



16

- GB** Drawer insert / Measuring tools  
**D** Schubladeneinlage / Messwerkzeuge  
**PL** Wkład do szuflady / Narzędzia miernicze  
**RUS** Вклад к выдвижному ящику / Измерительные приборы  
**CZ** Vložka do zásuvky / Měřeni  
**H** Fiókbetét / Méréseszközök  
**RO** Adaos la sertar / Instrumente de măsură  
**F** Module plastique pour servante / Outils de mesurage  
**I** Tenone per l'armadio / Strumenti di misura  
**E** Accesorio de cajón / Instrumentos de medición  
**CN** 量具托盘组套



5  
PCS



300 mm; 0-150 mm;  
 2 m;  
 3m x 16 mm; 0.02-1.00 mm



- GB** Drawer insert / Steel file set  
**D** Schubladeneinlage / Werkstatt-feilen  
**PL** Wkład do szuflady / Pilniki do metalu  
**RUS** Вклад к выдвижному ящику / Набор напильников слесарных  
**CZ** Vložka do zásuvky / Zámeňnicke pilníky  
**H** Fiókbetét / Lakatos reszelő  
**RO** Adaos la sertar / Pile de lăcătuserie  
**F** Module plastique pour servante / Fichier steel ensemble  
**I** Tenone per l'armadio / File di metallo  
**E** Accesorio de cajón / Juego de limas para metal  
**CN** 锉刀托盘组套



5  
PCS

T12  
STEEL



#2 200 mm;  
 #2 200 mm;  
 #2 200 mm;  
 #2 200 mm;  
 #2 200 mm





- GB Drawer insert / Hand riveter with rivets  
D Schubladeneinlage / Blindnietzange  
PL Wkład do szuflady / Nitownica ręczna z głowicą obrotową  
RUS Вклад к выдвижному ящику / Запечочник  
CZ Vložka do zásuvky / Ruční nýtovačka  
H Fiókbetét / Kézi popszegecsűző  
RO Adaos la sertar / Pclește pt. popnituri  
F Module plastique pour servante / Riveteuse a main  
I Tenone per l'armadio / Rivettatrice manuale girevole  
E Accesorio de cajón / Remachadora de mano  
CN 手动铆钉枪及铆钉托盘组套

PLASTIC TRAY & COLOR LABEL



6  
PCS

CrMo



2.4, 3.2, 4.0, 4.8 mm;  
9.6x3.2, 9.6x4.0, 12.7x4.0, 9.6x4.8, 12.7x4.8 mm

**YATO**  
YT-55466 8

- GB Drawer insert / Tool set  
D Schubladeneinlage / Sechskant-Steckschlüssel-Satz  
PL Wkład do szuflady / Zestaw narzędziowy  
RUS Вклад к выдвижному ящику / Набор инструмента  
CZ Vložka do zásuvky / Sada nástrčných klíčů a ráčny  
H Fiókbetét / Dugókulcs készlet racsnis hajtókarral  
RO Adaos la sertar / Rotrusa chei tubulare cu antrenor  
F Module plastique pour servante / Coffret d'outillage  
I Tenone per l'armadio / Set di utensili  
E Accesorio de cajón / Juego de herramientas  
CN 套筒扳手组套

PLASTIC TRAY & COLOR LABEL



6  
PCS

CrMo

CrV



1" (25 mm), L=330 mm;  
250 mm;

2.4, 3.2, 4.0, 4.8 mm;  
9.6x3.2, 9.6x4.0, 12.7x4.8 mm

**YATO**  
YT-55478 8

- GB Drawer insert / Automotive workshop tools  
D Schubladeneinlage / Kfz-werkzeuge  
PL Wkład do szuflady / Zestaw narzędzi warsztatowych  
RUS Вклад к выдвижному ящику / Автомобильные инструменты  
CZ Vložka do zásuvky / Auto nářadí  
H Fiókbetét / Autóipari szerszámok  
RO Adaos la sertar / Scule auto  
F Module plastique pour servante / Outils de réparation automobile  
I Tenone per l'armadio / Set attrezzi officina  
E Accesorio de cajón / Herramientas de automoción  
CN 轮胎修理工具托盘组套

PLASTIC TRAY & COLOR LABEL



5  
PCS

CrV



200 mm; 135 mm;  
300, 400, 500 mm

**YATO**  
YT-55477 4

- GB Drawer insert / Automotive workshop tools  
D Schubladeneinlage / Kfz-werkzeuge  
PL Wkład do szuflady / Zestaw narzędzi warsztatowych  
RUS Вклад к выдвижному ящику / Автомобильные инструменты  
CZ Vložka do zásuvky / Auto nářadí  
H Fiókbetét / Autóipari szerszámok  
RO Adaos la sertar / Scule auto  
F Module plastique pour servante / Outils de réparation automobile  
I Tenone per l'armadio / Set attrezzi officina  
E Accesorio de cajón / Herramientas de automoción  
CN 轮胎修理工具托盘组套

PLASTIC TRAY & COLOR LABEL



10  
PCS

CrV



1/2" (12.7 mm) x 5/16" (7.9 mm);  
PH3 (L=35 mm); PH1, PH2, PH3 (L=75 mm);  
8 mm (L=35 mm); 8 mm (L=75 mm);  
12-38 mm; 3" (75 mm); 82 mm

**YATO**  
YT-55476 4

- GB Drawer insert / Tool set  
D Schubladeneinlage / Sechskant-Steckschlüssel-Satz  
PL Wkład do szuflady / Zestaw narzędziowy  
RUS Вклад к выдвижному ящику / Набор инструмента  
CZ Vložka do zásuvky / Sada nástrčných klíčů a ráčny  
H Fiókbetét / Dugókulcs készlet racsnis hajtókarral  
RO Adaos la sertar / Rotrusa chei tubulare cu antrenor  
F Module plastique pour servante / Coffret d'outillage  
I Tenone per l'armadio / Set di utensili  
E Accesorio de cajón / Juego de herramientas  
CN 套筒扳手组套

PLASTIC TRAY & COLOR LABEL



23  
PCS



140 mm; 200 mm;  
19 mm x 20 mm; 4x190 mm; 250 V;  
1.0, 1.5, 2.0, 2.5, 3.0, 3.5, 4.0, 4.5, 5.0, 5.5,  
6.0, 6.5, 7.0, 7.5, 8.0, 8.5, 9.0, 9.5, 10.0 mm

**YATO**  
YT-55471 8

- GB Drawer insert / Taps and die set  
D Schubladeneinlage / Gewindeschneidwerkzeug-satz  
PL Wkład do szuflady / Zestaw narzynek i gwintowników  
RUS Вклад к выдвижному ящику / Набор плашек и метчиков  
CZ Vložka do zásuvky / Souprava závitníků a kruhových závitových čelistí  
H Fiókbetét / Menetfűró és menetvágó készlet  
RO Adaos la sertar / Set de tarozi și filiere  
F Module plastique pour servante / Pince a riveter avec embouts  
I Tenone per l'armadio / Set di filiera a maschi  
E Accesorio de cajón / Juego de machos de roscar y cojinetes  
CN 丝锥板牙托盘组套

PLASTIC TRAY & COLOR LABEL



35  
PCS

HCS



3x: M3x0.5, M4x0.7, M5x0.8, M6x1.0, M7x1.0, M8x1.25,  
M10x1.5, M12x1.75; M3x0.5, M4x0.7, M5x0.8, M6x1.0, M7x1.0, M8x1.25,  
M10x1.5, M12x1.75; 0.5 - 1.75 mm; 27G; 28G;  
M7-M9; M3-M12



**YATO**  
YT-55465 8



- |                                     |   |
|-------------------------------------|---|
| <b>GB</b> Drawer insert             | <b>RO</b> Adaos la sertar               |
| <b>D</b> Schubladeneinlage          | <b>F</b> Module plastique pour servante |
| <b>PL</b> Wkład do szuflady         | <b>I</b> Tenone per l'armadio           |
| <b>RUS</b> Вклад к выдвижному ящику | <b>E</b> Accesorio de cajón             |
| <b>CZ</b> Vložka do zásuvky         | <b>CN</b> 吸塑盒                           |
| <b>H</b> Fiókbetét                  |   |



for / dla: YAT-5531

|   |   |
|---|---|
| <b>YATO</b>  |  |
| YT-55311  | 5/30  |



for / dla: YAT-5532

|   |   |
|---|---|
| <b>YATO</b>  |  |
| YT-55321  | 5/30  |



for / dla: YAT-5533

|   |  |
|---|--|
| <b>YATO</b>  |  |
| YT-55331  | 5/30   |

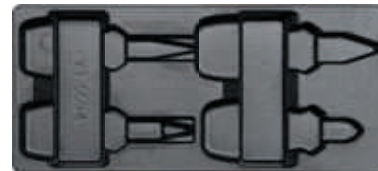

for / dla: YAT-5534

|   |   |
|---|---|
| <b>YATO</b>  |  |
| YT-55341  | 5/30  |

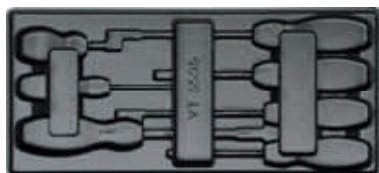

for / dla: YAT-5535

|   |   |
|---|---|
| <b>YATO</b>  |  |
| YT-55351  | 5/30  |

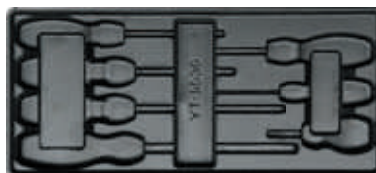

for / dla: YAT-5536

|   |  |
|---|--|
| <b>YATO</b>  |  |
| YT-55361  | 5/30   |



for / dla: YAT-5537

|   |   |
|---|---|
| <b>YATO</b>  |  |
| YT-55371  | 5/30  |

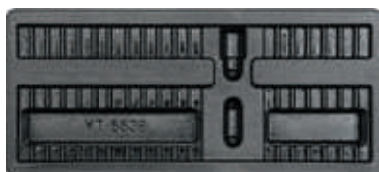

for / dla: YAT-5538

|   |   |
|---|---|
| <b>YATO</b>  |  |
| YT-55381  | 5/30  |



for / dla: YAT-5539

|   |  |
|---|--|
| <b>YATO</b>  |  |
| YT-55391  | 5/30   |



for / dla: YAT-5540

|   |   |
|---|---|
| <b>YATO</b>  |  |
| YT-55401  | 5/30  |

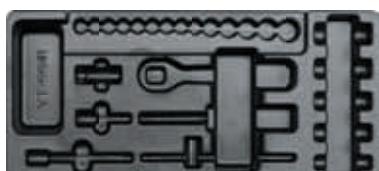

for / dla: YAT-5541

|   |   |
|---|---|
| <b>YATO</b>  |  |
| YT-55411  | 5/30  |



for / dla: YAT-5542

|   |  |
|---|--|
| <b>YATO</b>  |  |
| YT-55421  | 5/30   |



for / dla: YAT-55454

|   |   |
|---|---|
| <b>YATO</b>  |  |
| YT-55479  | 5/30  |

16

- |   |
|---|
| <b>GB</b> Legs for workbench, long                  |
| <b>D</b> Beine für Werkbank, lange                  |
| <b>PL</b> Nogi do stołu warsztatowego, długie       |
| <b>RUS</b> Ножи для верстака, длинные               |
| <b>CZ</b> Nohy k pracovnímu stolu, dlouhé           |
| <b>H</b> Labak munkapad, hosszú                     |
| <b>RO</b> Picioare pt. banc de lucru, lungi         |
| <b>F</b> Jambes pour table d'atelier                |
| <b>I</b> Gambe del tavolo piedi del banco da lavoro |
| <b>E</b> Patas para banco de trabajo, largas        |
| <b>CN</b> 工作台长桌腿                                    |





**2**  
PCS

**140**  
cm

WHITE  
CARTON BOX  
& COLOR LABEL

for / dla: YAT-08920

|   |                            |   |
|---|----------------------------|---|
| <b>YATO</b>  | <b>size / rozmiar (cm)</b> |  |
| YT-08921  | 140                        | 2   |

- |  |
|--|
| <b>GB</b> Holders for workshop box                                 |
| <b>D</b> Halterungen für die Montage eines Werkstattschranks       |
| <b>PL</b> Uchwyty do montażu szafki warsztatowej                   |
| <b>RUS</b> Крепеж для рабочего шкафа                               |
| <b>CZ</b> Montážní držáky dílenské skříňky                         |
| <b>H</b> Műhelyszekrény tartó                                      |
| <b>RO</b> Suporturi pt. montarea dulapului de atelier              |
| <b>F</b> Porte-placard d'atelier                                   |
| <b>I</b> Staffa di montaggio per armadio portautensili             |
| <b>E</b> Elementos de fijación para instalación de cajón de taller |
| <b>CN</b> 工具柜安装挂板  |





**2**  
PCS

**500x100**  
**x350 mm**

WHITE  
CARTON BOX  
& COLOR LABEL

for / dla: YAT-08920, YAT-09151, YAT-09152

|   |                            |   |
|---|----------------------------|---|
| <b>YATO</b>  | <b>size / rozmiar (mm)</b> |  |
| YT-08922  | 500x100x350                | 2   |



- GB Connection steel pipes set  
D Anschluss Stahlrohre Gesetzt  
PL Rury montażowe  
RUS Стальная труба монтаж  
CZ Ocelové trubky  
H Acélcövek  
RO Tevi din oțel  
F Tuyaux en acier  
I Set di montaggio per tabella utensili  
E Tubos de acero  
CN 工具柜连接杆



POLYBAG

2  
PCS

48.5  
x Ø2.8 cm

for / dla:  
YT-09151  
YT-09152  
YT-09155  
+  
YT-0902  
YT-0903  
YT-0904



| YATO     | size / rozmiar (cm) |    |
|----------|---------------------|----|
| YT-09071 | 48.5 x Ø 2.8        | 20 |

- GB Double project center backwall  
D Werkzeugwand  
PL Tablica narzędziowa  
RUS Доска инструмент  
CZ Držáky na nářadí  
H Szerszámtartó fal akasztókkal  
RO Suport perete scule  
F Mur d'outil  
I La tabella utensili  
E Panel de herramientas  
CN 工具车双挂板

POLYBAG

2  
PCS

65.2 x 61  
x 5.5 cm



for / dla:  
YT-0902 YT-55290  
YT-0903 YT-55292  
YT-09031 YT-55293  
YT-0904 YT-5530

| YATO     | size / rozmiar (cm) |   |
|----------|---------------------|---|
| YT-09072 | 65.2x61x5.5         | 2 |

- GB Compartmented shelf and paper roll holder  
D Werkstattwagenablage mit Papierrollehalter  
PL Półka z uchwytem na papier  
RUS Полка с держателем для бумаги  
CZ Police s úchytem na papír  
H Kiegészítő polc és papírolni tartó funkcióval  
RO Compartiment pt. dulap si suport hartie  
F Support rouleau papier  
I Mensola portarotoli carta  
E Estante con sujetapapel  
CN 托架



for / dla: YT-0902, YT-0903, YT-0904, YT-0905

| YATO    | size / rozmiar (mm) |   |
|---------|---------------------|---|
| YT-0907 | 305x305x145         | 4 |

- GB Dustbin  
D Abfalleimer  
PL Pojemnik na odpady  
RUS Мусорный ящик  
CZ Zásobník na odpad  
H Szemétkosár  
RO Lada de gunoi  
F Poubelle  
I Contenitore di rifiuti  
E Cubo de basura  
CN 废品箱



for / dla: YT-0902, YT-0903, YT-0904, YT-0905

| YATO    | size / rozmiar (mm) |   |
|---------|---------------------|---|
| YT-0908 | 300x300x190         | 4 |

- GB Separate board for drawer  
D Trennsteg für Werkstattwagen-Schublade  
PL Przegroda do szafki  
RUS Перегородки для ящика  
CZ Přehradka do police  
H Több rekeszes tálcá  
RO Sertar separat de masura mica  
F Cloison tiroir court  
I Separatore per armadio  
E Separador para armario  
CN 抽屉分隔板



for / dla: YT-0902, YT-0903, YT-0904, YT-0905

| YATO    | size / rozmiar (mm) |    |
|---------|---------------------|----|
| YT-0910 | 391x58x4            | 24 |
| YT-0911 | 391x128x4           | 12 |





GB Tool box  
D Werkzeugkasten  
PL Skrzynka narzędziowa  
RUS Инструментальный ящик  
CZ Skříňka na nářadí  
H Szerszámos láda

RO Cutie de scule  
F Boîte à outils  
I Cassetta degli attrezzi  
E Caja de herramientas  
CN 工具箱

WHITE  
CARTON BOX  
& COLOR LABEL

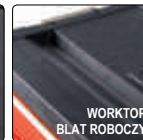
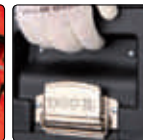

RUBBER CORNER  
GUMOWY NAROŻNIK

WORKTOP  
BLAT ROBOCZY



|             |                    |   |
|-------------|--------------------|---|
| <b>YATO</b> | drawers / szuflady |   |
| YT-09108    | 1                  | 2 |

|             |                    |   |
|-------------|--------------------|---|
| <b>YATO</b> | drawers / szuflady |   |
| YT-09107    | 2                  | 2 |

GB Tool trolley  
D Werkzeugkasten  
PL Wózek narzędziowy 3-częściowy  
RUS Тележка инструментальная  
CZ Vozík na nářadí  
H Szerszám kocsi  
RO Instrument cărucior  
F Servante d'atelier  
I Armadio per utensili  
E Herramienta carro  
CN 工具箱



WHITE  
CARTON BOX  
& COLOR LABEL

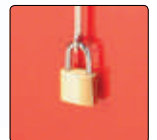

WORKTOP  
BLAT ROBOCZY

MODULES  
PROTECTION

ZABEZPIECZENIE  
MODUŁÓW

RUBBER CORNER  
GUMOWY NAROŻNIK



|             |   |
|-------------|---|
| <b>YATO</b> |   |
| YT-09102    | 1 |



|             |   |
|-------------|---|
| <b>YATO</b> |   |
| YT-09101    | 1 |





- GB Cantilever tool box
- D Werkzeugkoffer
- PL Skrzynka narzędziowa
- RUS Инструментальный ящик
- CZ Nástrojová skříňka
- H Szerszámosláda
- RO Cutie pt. scule
- F Boîte à outils
- I Cassetta degli attrezzi
- E Caja de herramientas
- CN 工具箱

WHITE  
CARTON  
BOX  
& COLOR  
LABEL







| YATO  | size / rozmiar (mm) |  |
|--|---------------------|---|
| YT-0882  | 360x150x115         | 4   |

| YATO  | size / rozmiar (mm) |  |
|--|---------------------|---|
| YT-0883  | 428x180x180         | 1   |





| YATO  | size / rozmiar (mm) |  |
|--|---------------------|---|
| YT-0884  | 460x200x180         | 1   |















| YATO  | size / rozmiar (mm) |  |
|--|---------------------|---|
| YT-0885  | 460x200x225         | 1   |

| YATO  | size / rozmiar (mm) |  |
|--|---------------------|---|
| YT-0886  | 510x220x240         | 1   |

- GB Tool box with tools
- D Werkzeugkoffer
- PL Skrzynka z narzędziami
- RUS Инструментальный ящик
- CZ Nástrojová skříňka
- H Szerszámosláda
- RO Cutie pt. scule
- F Boîte d'outils
- I Cassetta degli attrezzi
- E Caja de herramientas
- CN 工具组套



|           |                |   |   |             |
|-----------|----------------|---|---|-------------|
| 62<br>PCS | 1/2"<br>12.5mm | CrV<br>50BV30   | CrV<br>6150   | CrV<br>6140 |
| 72T       | AS-DRIVE       |  |  |             |



-  1/2" (12.7 mm): 10, 11, 12, 13, 14, 15, 16, 17, 18, 19, 20, 21, 22, 23, 24 mm (L=38 mm); 27, 30, 32 mm (L=42 mm); CrV 50BV30;
-  1/2" (12.7 mm): (76, 127, 254 mm); CrV 50BV30;
-  1/2" (12.7 mm): CrV 50BV30;
-  1/2" (12.7 mm): 21 mm; CrV 50BV30;
-  1/2" (12.7 mm): (255 mm); CrV 50BV30;
-  1/2" (12.7 mm): 72T; CrV 6140;
-  1/2" (12.7 mm): (450 mm); CrV 50BV30;
-  6, 7, 8, 9, 10, 11, 12, 13, 14, 15, 16, 17, 18, 19, 20, 21, 22, 24 mm; CrV;
-  6x100, 6x150, 8x200 mm; CrV 6150;
-  PH2x100, PH3x150, PH3x200 mm; CrV 6150;
-  180 mm; CrV;  160 mm; CrV;  160 mm; CrV;
-  1.5, 2, 2.5, 3, 4, 5, 6, 8, 10 mm; CrV 6150

WHITE  
CARTON  
BOX  
& COLOR  
LABEL



| YATO  | size / rozmiar (mm) |  |
|--|---------------------|---|
| YT-3895  | 475x230x365         | 1   |



GB Tool box with tools  
 D Werkzeugkoffer  
 PL Skrzynka z narzędziami  
 RUS Инструментальный ящик  
 CZ Nástrojová skříňka  
 H Szerszámoszláda  
 RO Cutie pt. scule  
 F Boîte d'outils  
 I Cassetta degli attrezzi  
 E Caja de herramientas  
 CN 工具组套



|           |                |               |             |             |
|-----------|----------------|---------------|-------------|-------------|
| 64<br>PCS | 1/2"<br>12.5mm | CrV<br>50BV30 | CrV<br>6150 | CrV<br>6140 |
| CrMo      | 72T            | AS-DRIVE      | ⊖           | ⊕           |

- 1/2" (12.7 mm): 10, 11, 12, 13, 14, 15, 16, 17, 18, 19, 20, 21, 22, 23, 24 mm (L=38 mm); 27, 30, 32 mm (L=42 mm); CrV 50BV30;
- 1/2" (12.7 mm): (76, 127, 254 mm); CrV 50BV30;
- 1/2" (12.7 mm): CrV 50BV30;
- 1/2" (12.7 mm): 21 mm; CrV 50BV30;
- 1/2" (12.7 mm): (255 mm); CrV 50BV30;
- 1/2" (12.7 mm): (255 mm); 72T; CrV 6140;
- 1/2" (12.7 mm): (457 mm); CrV 50BV30;
- 6, 7, 8, 9, 10, 11, 12, 13, 14, 15, 16, 17, 18, 19, 20, 21, 22, 24 mm; CrV;
- 5x100, 6x150, 8x200 mm; S2;
- PH1x100, PH2x150, PH3x200 mm; S2;
- 180 mm; CrV; 160 mm; CrV; 160 mm; CrV;
- 250 mm; CrV; 180 mm; CrMo;
- 1.5, 2, 2.5, 3, 4, 5, 6, 8, 10 mm; CrV 6150



|             |                     |   |
|-------------|---------------------|---|
| <b>YATO</b> | size / rozmiar (mm) |   |
| YT-38950    | 495x200x290         | 1 |



GB Tool box with tools  
 D Werkzeugkoffer  
 PL Skrzynka z narzędziami  
 RUS Инструментальный ящик  
 CZ Nástrojová skříňka  
 H Szerszámoszláda  
 RO Cutie pt. scule  
 F Boîte d'outils  
 I Cassetta degli attrezzi  
 E Caja de herramientas  
 CN 工具组套

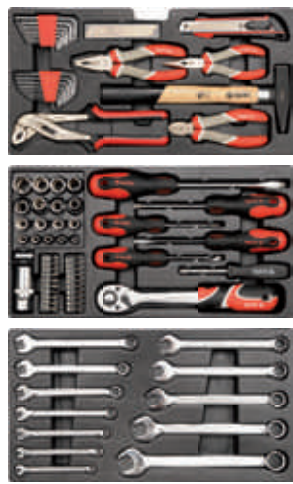

|           |                |               |               |             |
|-----------|----------------|---------------|---------------|-------------|
| 80<br>PCS | 1/2"<br>12.5mm | 1/4"<br>6.3mm | CrV<br>50BV30 | CrV<br>6140 |
| S2        | 72T            | AS-DRIVE      | ⊖             | ⊕           |



- 1/2" (12.7 mm): 10, 11, 12, 13, 14, 15, 17, 19 mm (L=38 mm);
- 1/4" (6.3 mm): 5, 6, 7, 8, 9, 10, 11, 12, 13 mm (L=25 mm); CrV 50BV30;
- 1/2" (12.7 mm): 21 mm; CrV 50BV30;
- 1/2" (12.7 mm): (255 mm); 72T; CrV 6140;
- 1/4" (6.3 mm): (150 mm); CrV 50BV30;
- 1/4" (6.3 mm) x 1/4" (6.3 mm); CrV 50BV30;
- 1/4" (6.3 mm): 3 (x2), 4 (x2), 5 (x2), 5.5 (x2), 6 (x2) mm (L=25 mm); AISI S2;
- 1/4" (6.3 mm): PH0, PH1 (x2), PH2 (x2), PH3 (L=25 mm); AISI S2;
- 1/4" (6.3 mm): PZ0, PZ1 (x2), PZ2 (L=25 mm); AISI S2;
- 6, 7, 8, 9, 10, 11, 12, 13, 14, 15, 17, 19 mm; CrV;
- 5x75 mm, 6x100 mm, 8x150 mm, PH1x75 mm, PH2x100 mm; S2;
- 180 mm; CrV; 160 mm; CrV; 160 mm; CrV;
- 250 mm; 300 g; 18 mm; SK2; 18x0.5 mm; SK2;
- 1.5, 2, 2.5, 3, 4, 5, 5.5, 6 mm; T10, T15, T20, T25, T27, T30, T40; CrV



|             |                     |   |
|-------------|---------------------|---|
| <b>YATO</b> | size / rozmiar (mm) |   |
| YT-38951    | 460x220x245         | 1 |



- GB Oil filter wrench
- D Ölfilterschlüssel
- PL Klucz do filtra oleju
- RUS Ключ к масляному фильтру
- CZ Klíč na olejový filtr
- H Olajszűrő kulcs
- RO Cheie pt. filtru de ulei
- F Clé au filtre d'huile
- I Chiave per filtro olio
- E Llave para el filtro de aceite
- CN 滤清器扳手

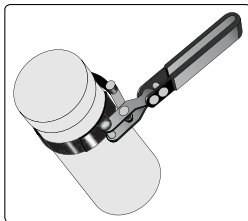
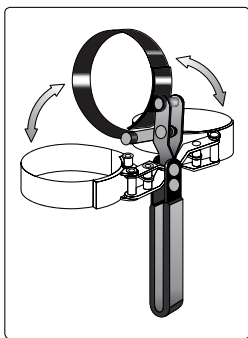
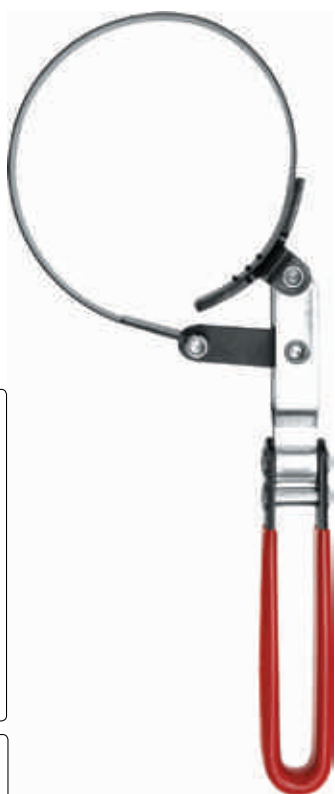

SLIDING CARD



| YATO    | Ø (mm) | Box   |
|---------|--------|-------|
| YT-0820 | 60-73  | 12/48 |
| YT-0821 | 73-85  | 12/48 |
| YT-0822 | 85-95  | 12/48 |
| YT-0823 | 95-111 | 12/48 |

- GB Belt oil wrench
- D Ölfilterschlüssel mit Riemen
- PL Klucz taśmowy do filtrów oleju
- RUS Ключ тросовый для масляных фильтров
- CZ Klíč na olejové filtry
- H Olajszűrő kulcs
- RO Cheie filtru cu banda
- F Clé au filtre d'huile
- I Chiave a nastro per filtro olio
- E Llave de cinta para filtros de aceite
- CN 皮帶鉗扳手



BLISTER CARD



| YATO    | Ø (mm)  | Box  |
|---------|---------|------|
| YT-0824 | 80-160  | 6/60 |
| YT-0825 | 100-200 | 5/20 |

- GB Oil filter wrench
- D Ölfilterschlüssel
- PL Klucz do filtra oleju
- RUS Съёмник масляных фильтров
- CZ Klíč na filtr oleju řetezový
- H Olajszűrő kulcs, láncos
- RO Cheie filtru ulei cu lanț
- F Clé au filtre d'huile
- I Chiave per filtro olio
- E Llave do filtro de cadenta
- CN 滤清器扳手



COLOR BOX



|                     |                 |                 |
|---------------------|-----------------|-----------------|
| 63-120 mm<br>2.5-4" | 3/8"<br>10.0 mm | 1/2"<br>12.5 mm |
| HRC 40-50           | CrV             |                 |

| YATO    | Box   |
|---------|-------|
| YT-0826 | 12/36 |

- GB Cap type oil filter wrench set
- D Steckschlüsselsatz für den Ölfilter
- PL Zestaw kluczy nasadowych do filtra oleju
- RUS Набор торцовых ключей к масляному фильтру
- CZ Sada miskovitých klíčů na olejové filtry
- H Dugókulcs készlet olajszűrőhöz
- RO Set de chei tubulare pt. filtru de ulei
- F Set d'embouts aux filtres d'huile
- I Set di chiavi filtro olio
- E Juego de llaves de tubo para el filtro de aceite
- CN 碗型滤清器扳手组套



15  
PCS

FIBRE  
REINFORCED  
POLYMER

3/8"  
10 mm

16

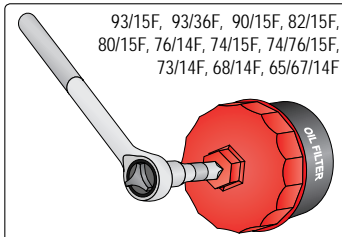

93/15F, 93/36F, 90/15F, 82/15F,  
80/15F, 76/14F, 74/15F, 74/76/15F,  
73/14F, 68/14F, 65/67/14F

BMC  
& COLOR  
SLEEVE



| YATO    | Ø             | Box |
|---------|---------------|-----|
| YT-0595 | 3/8" (9.5 mm) | 5   |



- GB Cap type oil filter wrench set
- D Steckschlüsselsatz für den Ölfilter
- PL Zestaw kluczy nasadowych do filtra oleju
- RUS Набор торцовых ключей к масляному фильтру
- CZ Sada miskovitých klíčů na olejové filtry
- H Dugókulcs készlet olajsűrőhöz

- RO Set de chei tubulare pt. filtru de ulei
- F Set d'embouts aux filtres d'huile
- I Set di chiavi filtro olio
- E Juego de llaves de tubo para el filtro de aceite
- CN 碗型滤清器扳手组套

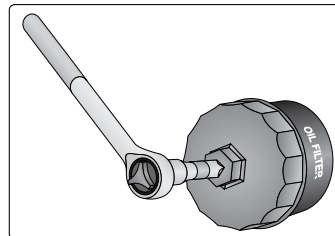

**13**  
PCS

**3/8"**  
10mm

**1/2"**  
12.5mm

**65-120**  
mm



BMC  
& COLOR  
SLEEVE



| YATO    | number | size    | layers  | grooves | faces        | car models                                      |
|---------|--------|---------|---------|---------|--------------|---|
|         | numer  | rozmiar | warstwy | bruzdy  | powierzchnie | modele samochodow                               |
| YT-0594 | 66/6   | SW66    | 1       | 6       |              | Fiat Punto 1.2, Renault Clio 1.2, Rapid, Twingo |
|         | 76/8   | SW76    | 1       | 8       |              | Fiat, Lancia                                    |
|         | 76/12  | SW76    | 1       |         | 12           | Fiat, Mercedes, Renault                         |
|         | 86/16  | SW86    | 1       |         | 16           | Volvo   |
|         | 86/18  | SW86    | 1       |         | 18           | VW Golf, Audi A6 TDI, Peugeot, Citroen          |
|         | 92/10  | SW92    | 1       |         | 10           | Fiat  |
|         | 93/45  | SW93    | 1       | 45      |              | VW, Audi TDI                                    |
|         | 96/18  | SW96    | 1       | 18      |              | Audi A4, A6 TDI, VQ Passat TDI, Renault Laguna  |
|         | 106/15 | SW106   | 1       |         | 15           | Fiat Ducato                                     |
|         | 108/15 | SW108   | 1       |         | 15           | Volvo   |
|         | 108/18 | SW108   | 1       | 18      |              | Renault Espace, Laguna, Safrane, Traffic        |

- GB Cap type oil filter wrench set
- D Steckschlüsselsatz für den Ölfilter
- PL Zestaw kluczy nasadowych do filtra oleju
- RUS Набор торцовых ключей к масляному фильтру
- CZ Sada miskovitých klíčů na olejové filtry
- H Dugókulcs készlet olajsűrőhöz

- RO Set de chei tubulare pt. filtru de ulei
- F Set d'embouts aux filtres d'huile
- I Set di chiavi filtro olio
- E Juego de llaves de tubo para el filtro de aceite
- CN 碗型滤清器扳手组套

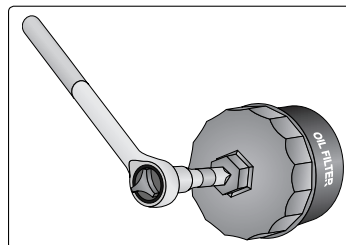

**30**  
PCS

**3/8"**  
10mm

BMC  
& COLOR  
SLEEVE



| YATO    | number | size    | layers  | grooves | faces                                    | car models                                      |
|---------|--------|---------|---------|---------|--|---|
|         | numer  | rozmiar | warstwy | bruzdy  | powierzchnie                             | modele samochodow                               |
| YT-0596 | 66/6   | SW66    | 1       | 6       |  | Fiat Punto 1.2, Renault Clio 1.2, Rapid, Twingo |
|         | 65/14  | SW65    | 1       |         | 14                                       | Daihatsu, Toyota, Nissan, Fiat                  |
|         | 65/67  | SW65-67 | 1       |         | 14                                       | Daihatsu, Toyota                                |
|         | 68/14  | SW68    | 1       |         | 14                                       | Mazda, Ford, Subaru                             |
|         | 73/14  | SW73    | 1       |         | 14                                       | Toyota, Lexus                                   |
|         | 74/15  | SW74    | 1       |         | 15                                       | Audi, Rover, Chrysler                           |
|         | 74/76  | SW74-76 | 2       |         | 15                                       | Ford, Opel, VW, Audi, Mercedes                  |
|         | 75/77  | SW75-77 | 2       |         | 15                                       | VW, Audi, Isuzu, Mercedes                       |
|         | 76/12  | SW76    | 1       |         | 12                                       | Fiat, Mercedes, Renault                         |
|         | 76/14  | SW76    | 1       |         | 14                                       | VW, Porsche, Mercedes, BMW, Audi, Opel          |
|         | 76/30  | SW76    | 1       | 30      |  | Ford  |
|         | 76/8   | SW76    | 1       | 8       |  | Fiat, Lancia                                    |
|         | 78/15  | SW78    | 1       |         | 15                                       | Nissan, Ford, Toyota                            |
|         | 80/15  | SW80    | 1       |         | 15                                       | Nissan, Honda, Opel, Mazda                      |
|         | 80/82  | SW80-82 | 2       |         | 15                                       | Subaru, Toyota, Honda, Nissan                   |
|         | 86/16  | SW86    | 1       |         | 16                                       | Volvo   |
|         | 86/18  | SW86    | 1       |         | 18                                       | VW Golf, Audi A6 TDI, Peugeot, Citroen          |
|         | 90/15  | SW90    | 1       |         | 15                                       | Honda, Mitsubishi, Isuzu                        |
|         | 92/10  | SW92    | 1       |         | 10                                       | Fiat  |
|         | 93/15  | SW93    | 1       |         | 15                                       | Mazda, Volvo, Mitsubishi, Nissan, Honda         |
|         | 93/36  | SW93    | 1       | 36      |  | Ford  |
|         | 93/45  | SW93    | 1       | 45      |  | VW, Audi TDI                                    |
|         | 95/15  | SW95    | 1       | 15      |  | Toyota, Alfa Romeo, Ford                        |
|         | 96/18  | SW96    | 1       | 18      |  | Audi A4, A6 TDI, VQ Passat TDI, Renault Laguna  |
|         | 100/15 | SW100   | 1       |         | 15                                       | Isuzu, Mitsubishi                               |
|         | 106/15 | SW106   | 1       |         | 15                                       | Fiat Ducato                                     |
|         | 108/15 | SW108   | 1       |         | 15                                       | Volvo   |
| 108/18  | SW108  | 1       | 18      |         | Renault Espace, Laguna, Safrane, Traffic |   |



- GB Oil filter sockets  
D Aufsätze für die Ölfilter  
PL Zestaw nasadek do filtrów oleju  
RUS Набор насадок к масляным фильтрам  
CZ Sada nástavců na olejové filtry  
H Olajszűrő leszedő készlet  
RO Set de cartușe pt. filtre de ulei  
F Set d'embouts aux filtres d'huile  
I Set di chiavi filtro olio  
E Juego de tapones para los filtros de aceite  
CN 滤油器套筒组套



|          |              |                   |
|----------|--------------|-------------------|
| 4<br>PCS | 3/8"<br>10mm | 27 32<br>36 38 mm |
| CrV      |              | AS-DRIVE          |



|             |               |    |
|-------------|---------------|----|
| <b>YATO</b> |               |    |
| YT-0598     | 3/8" (9.5 mm) | 20 |

- GB Oil drain plug set  
D Ölblessschrauben  
Schlüsselsatz  
PL Komplet kluczy  
do korków oleju  
RUS Комплект ключей  
для сливной пробки  
CZ Klíče nástrčné  
na zátky olejových van motorů  
H Olajleeresztő kulcs készlet  
RO Set bituri pt. bujon ulei  
F Ensemble de clés  
de bouchon de vidange d'huile  
I Set di chiavi a bussola  
E Juego de llaves  
para tapones de aceite  
CN 排油塞旋具组套

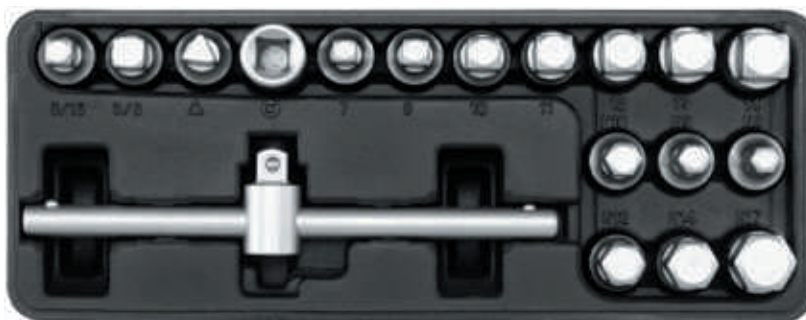

|            |              |                          |
|------------|--------------|--------------------------|
| 18<br>PCS  | 3/8"<br>10mm | 7 8 10 11 12<br>13 14 mm |
|            |              | 8 9 10 12<br>14 17 mm    |
|            |              | CrV                      |
| 8, 10 mm   | 10 mm        |                          |
| 5/16" 3/8" |              |                          |



|             |               |    |
|-------------|---------------|----|
| <b>YATO</b> |               |    |
| YT-0599     | 3/8" (9.5 mm) | 10 |

- 7, 8, 10, 11, 12, 13, 14 mm;   8, 9, 10, 12, 14, 17 mm;  
  5/16" (8 mm), 3/8" (10 mm);   10 mm;   10 mm;   160 mm

- GB Oil drain plug set  
D Ölblessschrauben Schlüsselsatz  
PL Komplet kluczy do korków oleju  
RUS Комплект ключей  
для сливной пробки  
CZ Klíče nástrčné na zátky  
olejových van motorů  
H Olajleeresztő kulcskészlet  
RO Set bituri pt. bujon ulei  
F Set de clés à vidange d'huile  
I Set di chiavi per tappi olio  
E Juego de llaves para tapones de aceite  
CN 排油塞旋具组套



|           |              |                            |
|-----------|--------------|----------------------------|
| 12<br>PCS | 3/8"<br>10mm | (mm)<br>8 11 13            |
|           |              | (mm)<br>8 9 10<br>12 14 17 |



|             |       |
|-------------|-------|
| <b>YATO</b> |       |
| YT-0600     | 10/20 |

- GB Oil pan thread repair set  
D Reparatursatz  
für Verschlussstopfen von Ölwannen  
PL Zestaw naprawczy korków  
do miski olejowej  
RUS Набор для ремонта масляных пробок  
CZ Souprava na opravu vupouštěcích  
šroubů olejových van  
H Olajteknő-csavar javító készlet  
RO Set pt. reparare dopuri baie de ulei  
F Kit réparation de bouchons  
de carter d'huile  
I Set per riparazione dei tappi  
della coppa del olio  
E Juego de reparación para  
los tapones del cárter de aceite  
CN 螺纹修复组套



|           |      |
|-----------|------|
| 64<br>PCS | CrMo |
|-----------|------|

- M13 M13 13 mm M17 M17 17 mm   
5 pcs 10 pcs 5 pcs 10 pcs   
M15 M15 15 mm M20 M20 20 mm   
5 pcs 10 pcs 5 pcs 10 pcs



|             |    |
|-------------|----|
| <b>YATO</b> |    |
| YT-1757     | 10 |

GB Lever action grease gun with rigid spout  
 D Handhebel-Fettpresse  
 PL Smarownica ręczna z końcówką sztywną  
 RUS Шприц для масляной смазки с твердым наконечником и гибким шлангом

CZ Páková maznice s pevnou koncovkou  
 H Karos zsírzó  
 RO Masina de gresat cu furturn rigid  
 F Pistolet de graissage manuel

I Lubrificatore manuale  
 E Pistola de engrase  
 CN 手动黄油枪

COLOR BOX



P max.  
70 MPa



P  
31 MPa

AI

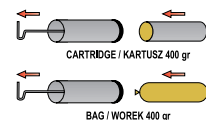

500 cm<sup>3</sup>



|   |   |
|---|---|
| <b>YATO</b>  |  |
| YT-0700   | 20  |



120 cm<sup>3</sup>

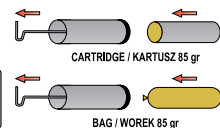

|   |   |
|---|---|
| <b>YATO</b>  |  |
| YT-0701   | 30  |



400 cm<sup>3</sup>

|   |   |
|---|---|
| <b>YATO</b>  |  |
| YT-0705   | 20  |

GB Grease gun  
 D Handhebel-Fettpresse  
 PL Smarownica ręczna  
 RUS Шприц для масляной смазки  
 CZ Páková maznice

H Karos zsírzó  
 RO Masina de gresat cu furturn rigid  
 F Pistolet de graissage manuel

I Lubrificatore manuale  
 E Pistola de engrase  
 CN 大容量黄油枪

COLOR BOX





P (MPa)  
27-41

AI



600 cm<sup>3</sup>

|   |   |
|---|---|
| <b>YATO</b>  |  |
| YT-07042  | 6/12  |



800 cm<sup>3</sup>

|   |   |
|---|---|
| <b>YATO</b>  |  |
| YT-07043  | 4/8   |



GB Two-way operation grease gun  
D Handhebel-Fettpresse  
PL Smarownica ręczna, wzmacniona  
RUS Шприц для масляной смазки  
CZ Páková maznice  
H Karos zsíröz

RO Masina de gresat cu furtun rigid  
F Pistolet de graissage manuel  
I Lubrificatore manuale  
E Pistola de engrase  
CN 大容量黄油枪

COLOR BOX



500 cm<sup>3</sup> P<sub>max.</sub> 70 MPa AI P 42 MPa

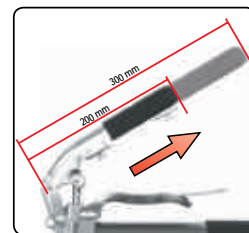

**YATO**  
YT-0704 12

HIGH PRESSURE  
69 MPa  
LOW VOLUME  
14 g / 40 STROKE

WYSOKIE CIŚNIENIE  
69 MPa  
NISKA WYDAJNOŚĆ  
14 g / 40 CYKLI

LOW PRESSURE  
6.9 MPa  
HIGH VOLUME  
100 g / 40 STROKE

NISKIE CIŚNIENIE  
6.9 MPa  
WYSOKA WYDAJNOŚĆ  
100 g / 40 CYKLI

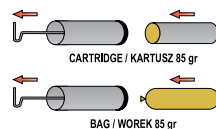

**YATO**  
YT-07041 10

GB Air grease gun  
D Druckluft-Fettpresse  
PL Smarownica pneumatyczna  
RUS Шприц для нагнетания  
густой смазки пневматический  
CZ Mazací lis pneumatický  
H Pneumatikus zsíröz  
RO Pistol pt. gresat pneumatic  
F Pistolet de graissage pneumatique  
I Pneumatica per ingrassaggio  
E Pistola engrasadora neumática  
CN 气动黄油枪

400 cm<sup>3</sup> 28 l/min 1/4" 6.3mm

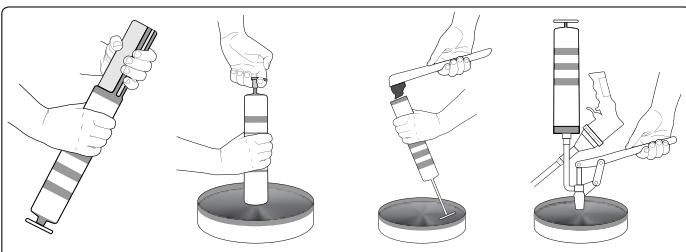

**YATO**  
YT-07055 10

- |                               |  |                                 |
|-------------------------------|--|---------------------------------|
| GB Oil transfer pump          | H Olajpumpa                              | E Bomba manual de trasvase dual |
| D Öl-Umfüllpumpe              | RO Pompa de ulei de mana                 | CN 输油泵                          |
| PL Pompa transferowa do oleju | F Pompe pour huile                       |                                 |
| RUS Шприц для перекачки масел | I Lubrificatore manuale per travaso olio |                                 |
| CZ Ruční olejová pumpa        |  |                                 |

COLOR BOX



**500**  
cm<sup>3</sup>

**P max.**  
**70** MPa

**P**  
**31** MPa



|             |    |
|-------------|----|
| <b>YATO</b> |    |
| YT-0707     | 20 |

- |  |  |
|--|--|
| GB Oil drainer                               | H Kézi olajszivattyú                         |
| D Öl-Absaugpumpe                             | RO Pompa de ulei                             |
| PL Odsysarka ręczna do oleju                 | F Seringue à huile                           |
| RUS Ручной шприц для откачки масла           | I Lubrificatore manuale per aspirazione olio |
| CZ Ruční odsávačka oleje                     | E Bomba manual de trasvase                   |
| H Kézi olajszivattyú                         | CN 输油泵                                       |
| RO Pompa de ulei                             |  |
| F Seringue à huile                           |  |
| I Lubrificatore manuale per aspirazione olio |  |
| E Bomba manual de trasvase                   |  |
| CN 输油泵                                       |  |

COLOR BOX



**500**  
cm<sup>3</sup>

**P max.**  
**70** MPa

**P**  
**31** MPa



|             |    |
|-------------|----|
| <b>YATO</b> |    |
| YT-0708     | 20 |

- |                       |                                |                            |
|-----------------------|--------------------------------|----------------------------|
| GB Grease pump        | RO Grăsime manual pompa        | E Grasa manual de la bomba |
| D Manuelle fettpumpen | F Pistolet de graissage manuel | CN 黄油泵                     |
| PL Smarownica ręczna  | I Pompa manuali per grasso     |                            |
| RUS Шприц для смазки  | E Grasa manual de la bomba     |                            |
| CZ Maznice ruční      | CN 黄油泵                         |                            |
| H Kézi zsírzó pumpa   |                                |                            |

GREY CARTON BOX & COLOR LABEL



**13.8**  
MPa  
(max)

**1.5m**  
HOSE  
WAZ



**4kg**

|             |                           |   |
|-------------|---------------------------|---|
| <b>YATO</b> | capacity / wydajność (kg) |   |
| YT-07061    | 4                         | 1 |



**8kg**

|             |                           |   |
|-------------|---------------------------|---|
| <b>YATO</b> | capacity / wydajność (kg) |   |
| YT-07063    | 8                         | 1 |

- |   |   |
|---|---|
| GB Flexible tube for grease gun         | H Tömlő a zsírzóhoz                     |
| D Schlauch für Fettpresse               | RO Furtun flexibil pt. pistol de grasat |
| PL Wąż do towotnicy                     | F Tuyau pour pistolet de graissage      |
| RUS Шприц для перекачки масел           | I Tubo flessibile per pompe grasso      |
| CZ Hadička na maznice na šmír           | E Manguera para engrasador              |
| H Tömlő a zsírzóhoz                     | CN 手用黄油枪软管                              |
| RO Furtun flexibil pt. pistol de grasat |   |
| F Tuyau pour pistolet de graissage      |   |
| I Tubo flessibile per pompe grasso      |   |
| E Manguera para engrasador              |   |
| CN 手用黄油枪软管                              |   |

SLIDING CARD



|             |        |        |
|-------------|--------|--------|
| <b>YATO</b> | L (mm) |        |
| YT-0709     | 300    | 12/144 |
| YT-0710     | 500    | 12/144 |



- GB Oiler with a flexible applicator  
D Ölkanne mit elastischem Applikator  
PL Oliwiarka z elastycznym aplikatorem  
RUS Масленка с гибким аппликатором  
CZ Olejníčka s ohebným aplikátorem  
H Hajlékony csőű olajozó  
RO Gresor cu aplicator flexibil  
F Burette à huile  
I Lubrificante con canna flessibile  
E Aceitera con aplicador flexible  
CN 油壶



IMPACT  
RESISTANT  
ODPORNE  
NA UDERZENIA



|             |                 |        |
|-------------|-----------------|--------|
| <b>YATO</b> | cm <sup>3</sup> |        |
| YT-0690     | 220             | 10/120 |
| YT-0691     | 270             | 10/120 |

|             |                 |        |
|-------------|-----------------|--------|
| <b>YATO</b> | cm <sup>3</sup> |        |
| YT-0690     | 220             | 10/120 |
| YT-0691     | 270             | 10/120 |



IMPACT  
RESISTANT  
ODPORNE  
NA UDERZENIA



|             |                 |        |
|-------------|-----------------|--------|
| <b>YATO</b> | cm <sup>3</sup> |        |
| YT-06913    | 300             | 10/120 |
| YT-06914    | 500             | 10/80  |

|             |                 |        |
|-------------|-----------------|--------|
| <b>YATO</b> | cm <sup>3</sup> |        |
| YT-06913    | 300             | 10/120 |
| YT-06914    | 500             | 10/80  |

- GB Oil pump  
D Öl-Umfüllpumpe  
PL Pompa tłokowa do oleju  
RUS Шприц ручной заливной  
CZ Ruční olejová pumpa  
H Olajpumpa  
RO Pompa de ulei de mana  
F Pompe pour huile  
I Pompa manuale  
E Bomba manual para aceite  
CN 手摇泵

|                        |                           |                                  |
|------------------------|---------------------------|----------------------------------|
| 16-18<br>l/min         | ▽h<br>45-90<br>cm         | 55<br>min <sup>-1</sup><br>(max) |
| 0.3 l<br>CYCLE<br>CYKL | FOR<br>OIL<br>DO<br>OLEJU | AI                               |

- GB Aluminium rotary oil pump  
D Aluminium-Kurbelpumpe  
PL Aluminiumowa pompa do oleju  
RUS Алюминиевый ручной  
бочковой насос  
CZ Hliník rotační čerpadlo  
H Alumínium rotációs szivattyú  
RO Aluminiu pompă rotativă  
F Pompe manuelle  
pour huile  
I Pompa a mano  
per olio  
E Aluminio bomba  
rotary  
CN 铝合金手摇油泵

|                  |                           |             |
|------------------|---------------------------|-------------|
| 21<br>l/min      | ▽h<br>500cm               | ▽h<br>300cm |
| 3xPIPE<br>3xRURA | FOR<br>OIL<br>DO<br>OLEJU | AI          |



COLOR BOX



|             |    |
|-------------|----|
| <b>YATO</b> |    |
| YT-0712     | 10 |

- GB High value rotary barrel pump  
D Kurbelpumpe für Benzinfässer  
PL Wysokowydajna pompa  
rotacyjna do paliwa  
RUS Насос топливный ротационный  
CZ Čerpadlo palivové rotační  
H Kézi pumpa hordóhoz (forgatható)  
RO Pompa rotativa pt. combustibil  
F Pompe rotative à combustible  
I Pompa rotativa travaso gasolio  
E Bomba de combustible rotatoria  
CN 手摇泵

FOR FUEL, DIESEL, OIL  
DO PALIW I OLEJU

|                        |              |
|------------------------|--------------|
| 1.0 l<br>CYCLE<br>CYKL | 100<br>l/min |
|------------------------|--------------|

ANTISTATIC HOSE  
2.4 m  
WAZ ANTYSTATYCZNY

BRASS FILTER  
180 µm  
MOSIĘZNY FILTR

▽h  
100cm

AI



WHITE  
CARTON BOX  
& COLOR LABEL



|             |   |
|-------------|---|
| <b>YATO</b> |   |
| YT-0715     | 4 |

GB Two arms jaw puller F Extracteur  
 D Abzieher-2-armig I Estrattore  
 PL Ściągacz dwuramienny E Extractor  
 RUS Съёмник для подшипников CN 两爪拉马  
 CZ Stahovák  
 H Csapaágylehűző  
 RO Extractor rulmenti



CrV

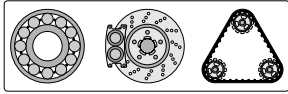

10 mm 4" 100 mm

10 mm 3" 75 mm

| YATO    | size / rozmiar | max. Ø (mm) | max. force / max. sila nacisku (t) | 6/60 |
|---------|----------------|-------------|------------------------------------|------|
| YT-2514 | 4" / 100 mm    | 60          | 1.2                                | 6/60 |

| YATO    | size / rozmiar | max. Ø (mm) | max. force / max. sila nacisku (t) | 6/60 |
|---------|----------------|-------------|------------------------------------|------|
| YT-2515 | 3" / 75 mm     | 75          | 1.1                                | 6/60 |

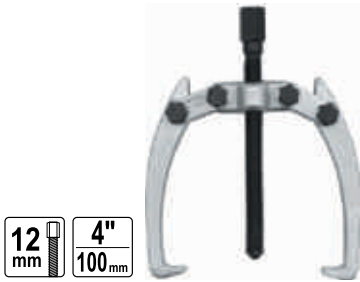

17 mm 6" 150 mm



22 mm 8" 200 mm



| YATO    | size / rozmiar | max. Ø (mm) | max. force / max. sila nacisku (t) | 12/48 |
|---------|----------------|-------------|------------------------------------|-------|
| YT-2516 | 4" / 100 mm    | 100         | 1.4                                | 12/48 |

| YATO    | size / rozmiar | max. Ø (mm) | max. force / max. sila nacisku (t) | 10/20 |
|---------|----------------|-------------|------------------------------------|-------|
| YT-2517 | 6" / 150 mm    | 120         | 6                                  | 10/20 |

| YATO    | size / rozmiar | max. Ø (mm) | max. force / max. sila nacisku (t) | 6 |
|---------|----------------|-------------|------------------------------------|---|
| YT-2518 | 8" / 200 mm    | 180         | 9                                  | 6 |

GB Three arms jaw puller F Extracteur  
 D Abzieher-3-armig I Estrattore  
 PL Ściągacz trójramienny E Extractor detres patas  
 RUS Съёмник для подшипников CN 三爪拉马  
 CZ Stahovák třiramenný  
 H Csapaágylehűző  
 RO Extractor rulmenti cu trei brate



CrV

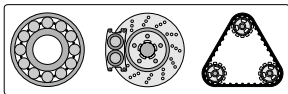

10 mm 3" 75 mm

12 mm 4" 100 mm

| YATO    | size / rozmiar | max. Ø (mm) | max. force / max. sila nacisku (t) | 6/60 |
|---------|----------------|-------------|------------------------------------|------|
| YT-2519 | 3" / 75 mm     | 80          | 1.5                                | 6/60 |

| YATO    | size / rozmiar | max. Ø (mm) | max. force / max. sila nacisku (t) | 6/36 |
|---------|----------------|-------------|------------------------------------|------|
| YT-2520 | 4" / 100 mm    | 100         | 2.5                                | 6/36 |

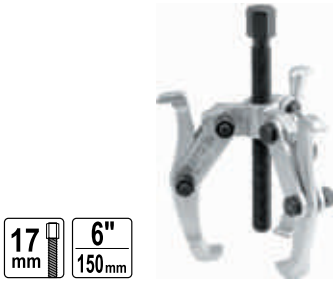

22 mm 8" 200 mm



22 mm 12" 300 mm



| YATO    | size / rozmiar | max. Ø (mm) | max. force / max. sila nacisku (t) | 12 |
|---------|----------------|-------------|------------------------------------|----|
| YT-2521 | 6" / 150 mm    | 130         | 5                                  | 12 |

| YATO    | size / rozmiar | max. Ø (mm) | max. force / max. sila nacisku (t) | 4 |
|---------|----------------|-------------|------------------------------------|---|
| YT-2522 | 8" / 200 mm    | 180         | 9                                  | 4 |

| YATO    | size / rozmiar | max. Ø (mm) | max. force / max. sila nacisku (t) | 2 |
|---------|----------------|-------------|------------------------------------|---|
| YT-2523 | 12" / 300 mm   | 180         | 11                                 | 2 |

GB Three arms jaw puller F Extracteur  
 D Abzieher-3-armig I Estrattore  
 PL Ściągacz trójramienny E Extractor detres patas  
 RUS Съёмник для подшипников CN 三爪拉马  
 CZ Stahovák třiramenný  
 H Csapaágylehűző  
 RO Extractor rulmenti cu trei brate



CrV

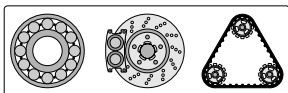

14 mm 3" 75 mm

| YATO    | size / rozmiar | Ø (mm) | 20 |
|---------|----------------|--------|----|
| YT-2511 | 3" / 75 mm     | 50-150 | 20 |

15 mm 4" 100 mm

| YATO    | size / rozmiar | Ø (mm) | 20 |
|---------|----------------|--------|----|
| YT-2512 | 4" / 100 mm    | 60-200 | 20 |

19 mm 6" 150 mm

| YATO    | size / rozmiar | Ø (mm) | 10 |
|---------|----------------|--------|----|
| YT-2513 | 6" / 150 mm    | 80-300 | 10 |



- GB Universal puller set  
D Abziehvorrichtung für Lager  
PL Ściągacz do łożysk w miejscach trudnodostępnych  
RUS Съёмник подшипников в труднодоступных местах  
CZ Sada na stahování ložisek na obličejně dostupných místech  
H Csapágyelhúzó nehezen hozzáférhető helyekhez  
RO Trăgător pt. rulmenți în locuri greu accesibile  
F Extracteur aux roulements  
I Set di estrattori universali  
E Extractor de rodamientos en lugares de difícil acceso  
CN 多功能拉拔器

3 x 250 mm;

3 x 200 mm;

3 x 100 mm;

160 mm;

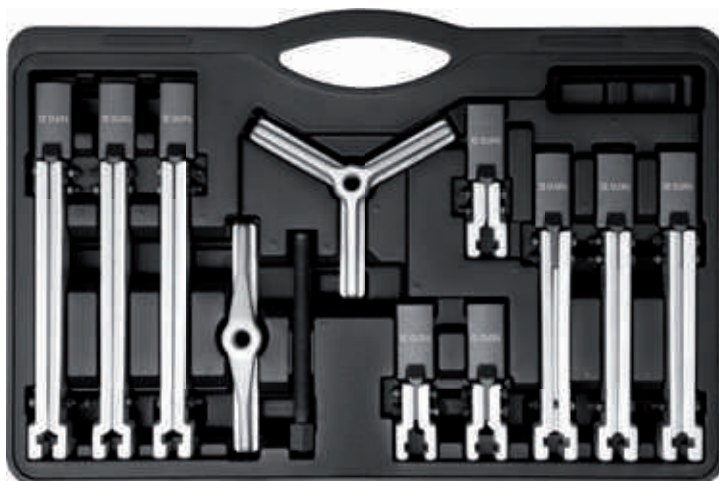
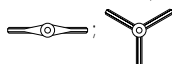

12  
PCS

DROP  
FORGED  
KUTE

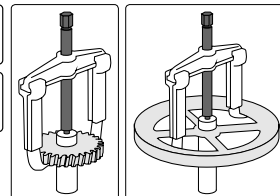

BMC  
& COLOR  
SLEEVE



|             |  |   |
|-------------|--|---|
| <b>YATO</b> |  |   |
| YT-25105    |  | 2 |

- GB Pilot bearing puller  
D Abzieher für Innenlager  
PL Ściągacz do łożysk wewnętrznych  
RUS Съёмник внутренних подшипников  
CZ Stahovák na ložiska vnitřní  
H Csapágyelhúzó, belső  
RO Clește interior pt. extras rulmenți  
F Extracteur intérieur aux roulements  
I Estrattore cuscinetti  
E Extractor de cojinetes inter.  
CN 轴承拉马

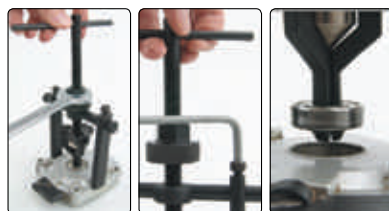

12-38  
mm

CrV  
6150



COLOR BOX



|             |        |    |
|-------------|--------|----|
| <b>YATO</b> | ∅ (mm) |    |
| YT-2510     | 12-38  | 20 |

- GB Universal wheel hub puller  
D Scheiben- und Trommelbremsen Abzieher  
PL Ściągacz uniwersalny do tarcz i bębnow  
RUS Универсальный съёмник ступицы и полуоси  
CZ Stahovák na brzdové bubny  
H Univerzális féktárcsa és fékdob lehúzó

- RO Trusa universala pt. transmisie cardanica  
F Extracteur universel pour les disques et les tambours  
I Estrattore a vite universale  
E Extractor universal de discos y tambores  
CN 万用轮毂拉马

CrV

90-140 mm

130-180 mm

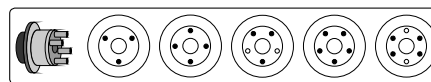

METAL CASE & COLOR BOX



|             |        |   |
|-------------|--------|---|
| <b>YATO</b> | L (mm) |   |
| YT-0602     | 200    | 6 |

- GB Separator and hydraulic cylinder turnbuckle  
D Separator und Abziehvorrichtung mit Hydraulikservomotor  
PL Separator i ściągacz z silownikiem hydraulicznym  
RUS Сепаратор и съёмник с сервомотором  
CZ Oddělovač a stahovák s hydraulickým válcem  
H Csapágyelhúzó és körmös csapágyelhúzó hidraulikus kézpumpával  
RO Separator și ancoră cu servomotor hidraulic  
F Séparateur avec actionneur hydraulique  
I Separatore frizione cilindro idraulico  
E Separador y tensor de tornillo con cilindro hidráulico  
CN 液压分离器组合

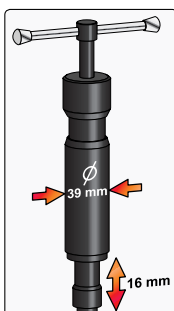

75-105 mm  
88-160 mm

50  
kN

HRC  
38-45

DROP  
FORGED  
KUTE

HYDRAULIC  
CYLINDER  
SIŁOWNIK  
HYDRAULICZNY

CrV

METAL CASE & COLOR BOX



|             |        |   |
|-------------|--------|---|
| <b>YATO</b> | F (kN) |   |
| YT-0609     | 50     | 2 |

- GB Twin leg puller with jaw hook
- D Doppel Abzieher mit Haken
- PL Ściągacz uniwersalny dwuramienny
- RUS Съёмник универсальный
- CZ Stahovák dvouramenný univerzální
- H Csapágyelhúzó készlet
- RO Carlig cu falci pt. extras cu picor dublu
- F Extracteur universel à deux bras
- I Estrattore universale a due bracci
- E Extractor de cuatro patas
- CN 单边两爪拉马

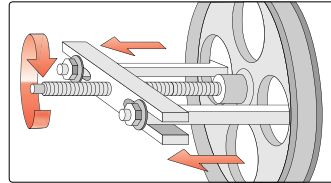
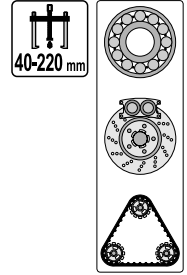

**YATO**  
YT-0640 10

- GB Gear puller set
- D Lagerabzieher, Trennmesser
- PL Ściągacz dwuramienny i separator
- RUS Съёмник универсальный с сепаратором
- CZ Stahovák dvouramenný
- H Csapágyelhúzó készlet
- RO Set angrenaj pt. extras
- F Extracteur 2 bras + separateur
- I Estrattore a due bracci a separatore
- E Kit de extractor
- CN 齿轮拉拔器

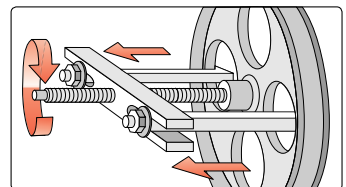
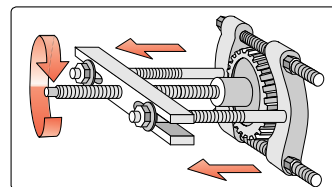
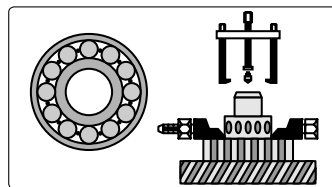
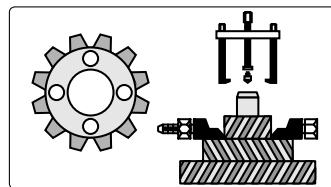
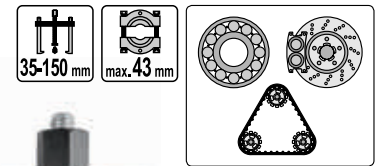

**YATO**  
YT-0641 4

16

- GB Steering wheel remover / lock plate compressor set
- D Abziehvorrichtung für das Lenkrad
- PL Ściągacz kola kierownicy / sprężarki
- RUS Съёмник рулевого колеса
- CZ Přípravek na stahování volantu
- H Kormánykerék-lehúzó
- RO Volar puller
- F Extracteur du volant et du compresseur
- I Set estrattore smontaggio volante
- E Desmontador para el volante
- CN 方向盘拆装器

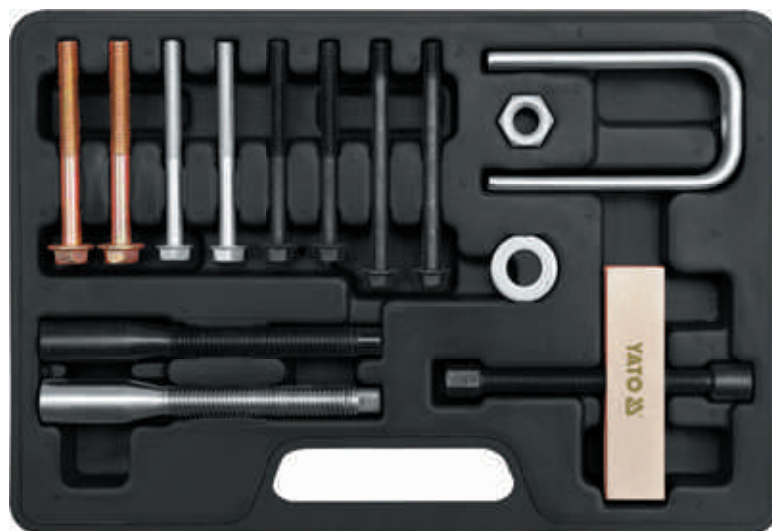

- 5/16" x 101 mm, 18 TPI;
- M8 x 89 mm;
- 3/8" x 89 mm, 16 TPI;
- 5/16" x 89 mm, 24 TPI;
- M14 x 1.5 mm;
- 9/16", 18 TPI;

14  
PCS

BMC  
& COLOR  
SLEEVE



**YATO**  
YT-2545 10



- GB Slide hammer gear / bearing puller set  
D Träge Abziehvorrichtung für Lager  
PL Ściągacz bezwładnościowy do łożysk  
RUS Инерционный съемник подшипников  
CZ Rázový stahovák s kluzným kladivem na ložiska  
H Csúszósúlyos csapágyelhúzó készlet

- RO Set ciocan culisant extractor de rulmenti  
F Extracteur de roulements à inertie  
I Set estrattori interni / esterni  
E Extractor de inercia para cojinetes  
CN 滑锤轴承拉拔器组套

5  
PCS

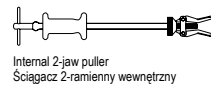
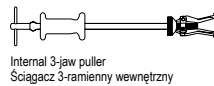
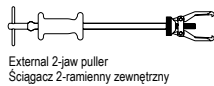
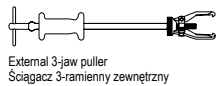
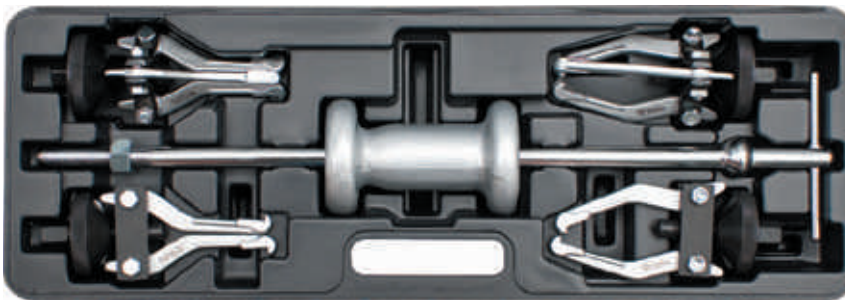
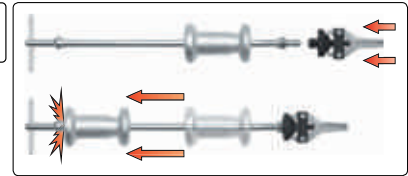

|             |   |
|-------------|---|
| <b>YATO</b> |   |
| YT-2540     | 2 |

- GB Slide hammer set  
D Träge Abziehvorrichtung für Naben und Lager  
PL Ściągacz bezwładnościowy do piast i łożysk  
RUS Инерционный съемник ступиц и подшипников  
CZ Rázový stahovák s kluzným kladivem na náboje a ložiska  
H Csúszósúlyos kerékagy - és csapágyelhúzó készlet

- RO Set ciocan culisant extractor de rulmenti și bucșe  
F Extracteur de roulements et moyeux à inertie  
I Set estrattori per cuscinetti interno  
E Extractor de inercia para cubos y cojinetes  
CN 滑锤轴承拉拔器组套

13  
PCS

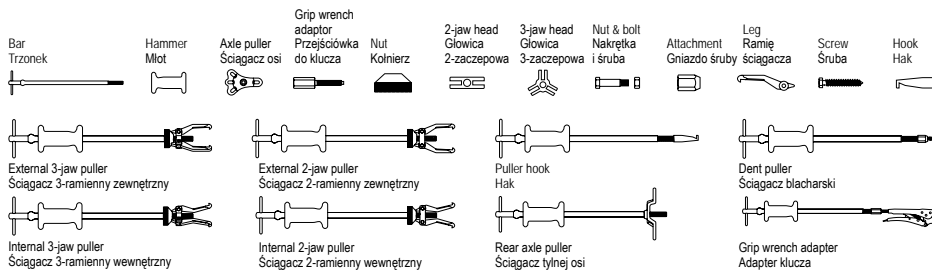
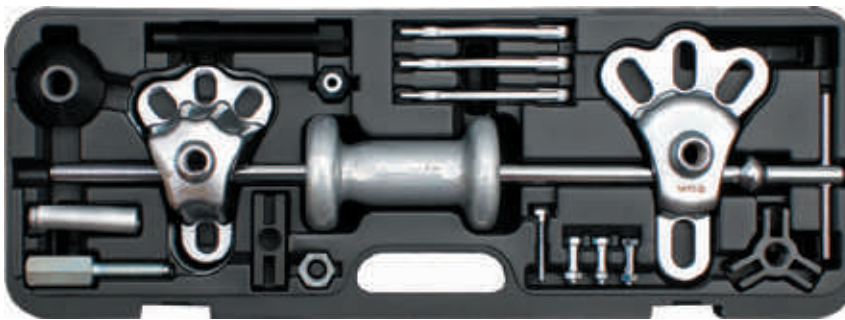
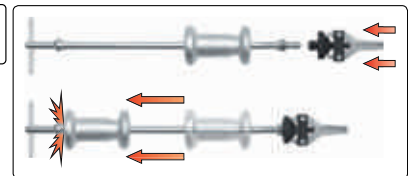

|             |   |
|-------------|---|
| <b>YATO</b> |   |
| YT-2539     | 2 |

- GB Front wheel bearing adapter set  
D Radlagerabzieher werkzeugsatz vorderachse  
PL Ściągacz łożysk piasty przedniej  
RUS Набор для снятия переднего подшипника переднеприводных автомобилей  
CZ Sada na demontáž ložisek přední nápravy  
H Csapágyelhúzó adapter készlet első futóműhöz  
RO Set schimbat rulment roata fata  
F Extracteur de moyeux  
I Set estrattori per cuscinetti ruota anteriore adattatore universale  
E Extractor de cojinetes para cubos de rueda delanteros  
CN 轴承拆装组套

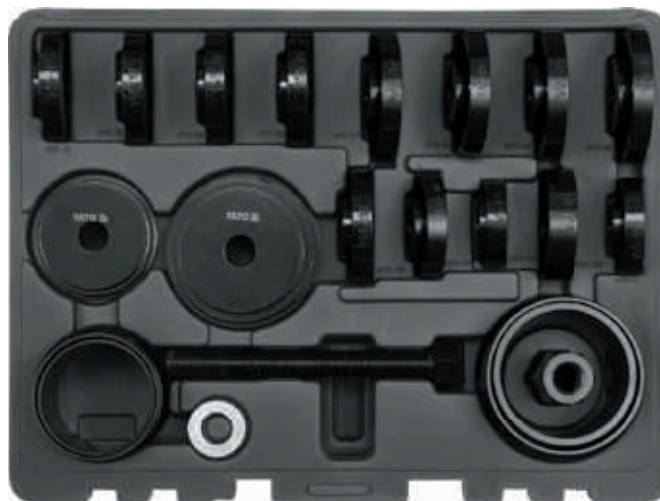
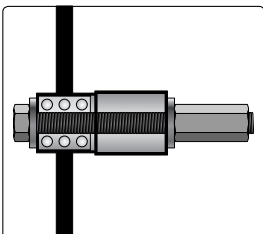

23  
PCS

FOR FRONT WHEEL BEARING DO ŁOŻYSK PIASTY PRZEDNIEJ



|             |   |
|-------------|---|
| <b>YATO</b> |   |
| YT-2541     | 2 |



GB Small mouth pull clamp  
 D Selbstklemmende Blechschele  
 PL Klamra blacharska samozaciskowa  
 RUS Скрепa самозажимная для жестяных работ  
 CZ Karosářská svěrka samosvorná k tahání

H Önszorító húzóató pofa, egyenes  
 RO Clemă pt. tablă cu strângere automată  
 F Boucle pour tôle auto-serrant

I Grappa  
 E Grapa de hojalatería autoprensora  
 CN 窄型张引夹

**5t** **125 mm** **42x20mm JAWS SZCZĘKI** **AUTO-TIGHTEN SAMO-ZACISKOWA**

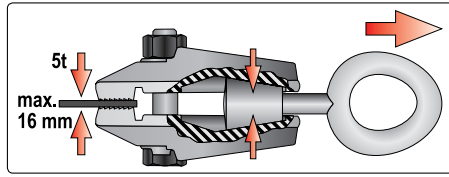

|             |        |    |
|-------------|--------|----|
| <b>YATO</b> | L (mm) |    |
| YT-2542     | 125    | 12 |

GB Box clamp  
 D Selbstklemmende Blechschele vom Typ „C“  
 PL Klamra blacharska samozaciskowa typu „C“  
 RUS Скрепa самозажимная для жестяных работ типа „C“  
 CZ Karosářská svěrka samosvorná k tahání typ „C“  
 H Önszorító húzóató pofa, öblös  
 RO Clemă pt. tablă cu strângere automată de tip „C“  
 F Boucle pour tôle auto-serrant

I Grappa tipo „C“  
 E Grapa de hojalatería autoprensora tipo „C“  
 CN 宽型张引夹

**3t** **142 mm** **35x15mm JAWS SZCZĘKI** **TYPE C** **AUTO-TIGHTEN SAMO-ZACISKOWA**

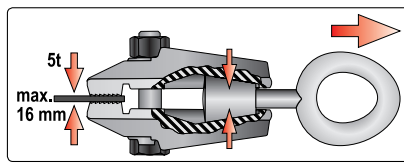

|             |        |    |
|-------------|--------|----|
| <b>YATO</b> | L (mm) |    |
| YT-2543     | 142    | 10 |

GB Twist socket set  
 D Schraubendrehersatz  
 PL Zestaw wykrętek do śrub  
 RUS Инструмент для удаления сломанных винтов  
 CZ Sada vyťahováku stržených šroubů  
 H Kicsavaró készlet csavarokhoz

RO Set de chei pt. șuruburi  
 F Set d'extracteurs aux vis  
 I Set estrattori per dadi  
 E Juego de destornilladores  
 CN 螺栓取出器组套

**10 PCS**  
**3/8"**  
**10mm**  
**CrMo**  
**HRC 52-55**

GB Screw extractor set & HSS drill bits  
 D Schraubenausdrehsatz & HSS Bohrer  
 PL Wykrętki do zerwanych śrub i wiertła do metalu HSS  
 RUS Экстракторы и сверла по металлу HSS  
 CZ Vrtáky do přetržených šroubů & vrtáky na kov HSS  
 H Törtcsavar kihajító & főrészár fémhez HSS  
 RO Capete pt. deșurubat șuruburi rupte & burghie pt. metal HSS  
 F Set d'extracteurs aux vis  
 I Estrattori di vite HSS  
 E Destornillador para tornillos arrancados & HSS brocas  
 CN 断丝取出器组套

**12 PCS** **HSS**  
**M3-M24**

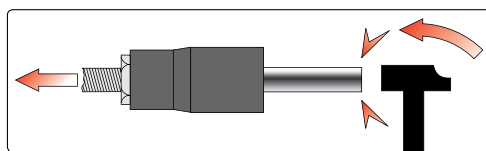

|             |  |      |
|-------------|--|------|
| <b>YATO</b> |  |      |
| YT-0603     |  | 8/32 |



| <b>YATO</b> | Ø (mm)   | M     | Ø [mm] |    |
|-------------|----------|-------|--------|----|
| YT-0591     | 1.4-3.6  | 3-6   | 1.8    | 40 |
|             | 2.1-4.9  | 6-8   | 2.6    |    |
|             | 3.1-6.5  | 8-11  | 3.7    |    |
|             | 4.8-8.8  | 11-14 | 5.5    |    |
|             | 6.2-11.0 | 14-18 | 7.0    |    |
|             | 9.4-15.0 | 18-24 | 10.3   |    |

GB Screw extractor set  
 D Schraubenausdrehsatz  
 PL Wykrętki do zerwanych śrub  
 RUS Набор для извлечения обломанных болтов  
 CZ Vrtáky do přetržených šroubů  
 H Törtcsavar kihajító  
 RO Capete pt. deșurubat șuruburi rupte  
 F Set d'extracteurs aux vis  
 I Estrattori di viti  
 E Destornillador para tornillos arrancados  
 CN 断丝取出器组套



**PLASTIC BOX & SLIDING CARD** **6 PCS**

| <b>YATO</b> | Ø (mm) | L (mm) |       |
|-------------|--------|--------|-------|
| YT-0590     | 3-6    | 52     | 12/48 |
|             | 6-8    | 58     |       |
|             | 8-11   | 66     |       |
|             | 11-14  | 75     |       |
|             | 14-18  | 80     |       |
|             | 18-25  | 88     |       |



- GB Bolt extractor set  
D Satz von Ausziehvorrichtungen für Stifte  
PL Zestaw wykrętek do szpilek  
RUS Набор экстракторов для шпилек  
CZ Souprava na demontáž závrtných šroubů  
H Csavarkihajító készlet  
RO Set de șurubelnițe pt. tije

- F Set d'extracteurs aux épingles  
I Set bussole estrattore per brugola  
E Juego de extractores de alfileres  
CN 断丝取出器组套

BMC & COLOR SLEEVE



STEEL  
8660

HRC  
49-52

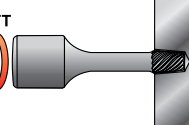

6  
PCS

3/8"  
10mm



5  
PCS

1/2"  
12.5mm

| YATO    | Ø (mm)            |    |
|---------|-------------------|----|
| YT-0623 | 2; 3; 4; 6; 8; 10 | 50 |

| YATO    | Ø (mm)            |    |
|---------|-------------------|----|
| YT-0624 | 8; 10; 12; 14; 16 | 20 |

- GB Heavy duty nut splitter  
D Meißelsatz für Schraubenmutter  
PL Zestaw przecinaków do nakrętek  
RUS Набор зубил для гаек  
CZ Souprava sekáčů na matice  
H Csavaranya-vágó  
RO Set retezatoare capace  
F Set de burins  
I Set estrattore dado  
E Juego de tajaderas para tuercas  
CN 螺母破拆组套



BMC & COLOR SLEEVE



4  
PCS

CrV

HRC  
40-45

5/16" - 1/2" (9 - 12 mm);  
1/2" - 5/8" (12 - 16 mm);  
5/8" - 7/8" (16 - 22 mm);  
7/8" - 1-1/16" (22 - 27 mm)

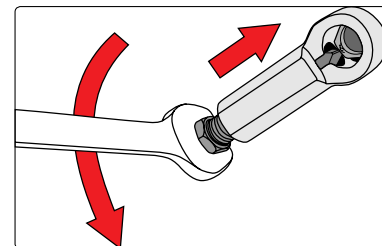

| YATO    |    |
|---------|----|
| YT-0585 | 10 |

- GB Roller stud extractor set  
D Slehbolzenlösersatz  
PL Komplet wykrętek do szpilek  
RUS Набор ключей для снятия штифтов  
CZ Sada stahovadel na špendlíky  
H Komplet tükkihúzó  
RO Set de dispozitive pt. demontaj șuruburi rupte  
F Set d'extracteurs de goupilles  
I Estrattori a rulli per viti prigioniere  
E Juego de extractores de agujas  
CN 断丝取出器组套



4  
PCS

CrV  
50BV30

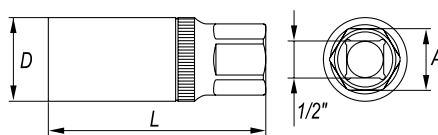
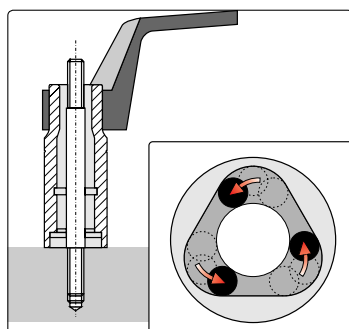

BMC & COLOR SLEEVE



| YATO    | ● (mm) | D (mm) | L (mm) | A (mm) |      |
|---------|--------|--------|--------|--------|------|
| YT-0620 | 6      | 24     | 60     | 21     | 6/24 |
|         | 8      |        |        |        |      |
|         | 10     | 28     | 70     |        |      |
|         | 12     |        |        |        |      |

GB Tie rod end lifter  
 D Universal-Kugelgelenk-Abzieher  
 PL Ściągacz do sworzni kulistych  
 RUS Съёмник шаровых опор  
 CZ Stahovák kulových čepů řízení  
 H Gömbfej kinyomó

RO Extractor pt. articulatii sferice  
 F Extracteur de rotue  
 I Estrattore per snodi sferici  
 E Extractor de pernos esféricos  
 CN 球头拉拔器

135 mm



| YATO    | (mm) | L (mm) | Ø (mm) |      |
|---------|------|--------|--------|------|
| YT-0612 | 19   | 135    | 17.5   | 9/18 |

GB Tie rod end lifter  
 D Universal-Kugelgelenk-Abzieher  
 PL Ściągacz do sworzni kulistych  
 RUS Съёмник шаровых опор  
 CZ Stahovák kulových čepů řízení  
 H Gömbfej kinyomó

RO Extractor pt. articulatii sferice  
 F Extracteur de rotue  
 I Estrattore per snodi sferici  
 E Extractor de pernos esféricos  
 CN 球头拉拔器

265 mm

275 mm



| YATO    | (mm) | L (mm) | Ø (mm) |    |
|---------|------|--------|--------|----|
| YT-0613 | 16   | 265    | 17     | 20 |
| YT-0614 | 16   | 275    | 20     | 20 |

GB Rod end remover  
 D Lenkstangeabzieher  
 PL Ściągacz do drążków kierowniczych  
 RUS Съёмник рулевых тяг  
 CZ Přípravek na demontáž kulových čepů řízení  
 H Gömbfej kiütő  
 RO Tija pt. indepártat  
 F Extracteur pour rotules de direction  
 I Estrattori perni e tiranti sterzo  
 E Extractor de barras de acoplamiento  
 CN 拉拔器



200 mm

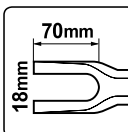

| YATO    | L (mm) |       |
|---------|--------|-------|
| YT-0615 | 200    | 18/36 |

GB Inner tie rod tool  
 D Spurstangengelenk Lösewerkzeug  
 PL Klucz do drążków kierowniczych  
 RUS Ключ для шарнира рулевой рейки  
 CZ Přípravek na axiální táhla  
 H Csukló szerelő  
 RO Cheia de la tija de cravată  
 F Clé pour rotules de direction  
 I Chiave per il tirante  
 E Extractor mecanismo de dirección  
 CN 大机舵扳手



Ø mm 35-42



| YATO    |  |    |
|---------|--|----|
| YT-0616 |  | 25 |

GB Track rod end remover & installer set  
 D Schlüsselsatz für Zahnstangenlenkung  
 PL Zestaw kluczy do drążków kierowniczych  
 RUS Набор ключей для рулевых тяг  
 CZ Sada klíčů pro hřeben řízení  
 H Kormányrúd telepítő készlet-eltávolító  
 RO Îndepărtare & instalare set baghetă de volan  
 F Clé pour rotules de direction  
 I Set di chiavi suggerimenti smontaggio tiranti sterzo  
 E Herramienta de llaves para barras de dirección  
 CN 件套轴接头工具组



4 PCS

Ø mm 30-45

BMC & COLOR SLEEVE



Ø 30-35mm, 35-40mm, 40-45mm

| YATO     |  |   |
|----------|--|---|
| YT-06155 |  | 2 |

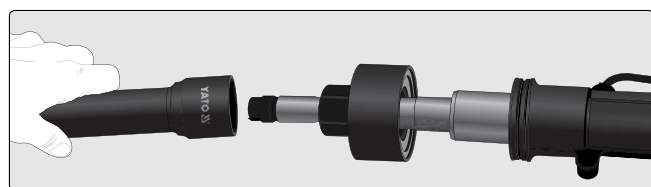



- GB Tie rod / ball joint tool kit
- D Werkzeugsatz für Bremssattel
- PL Ściągacze do drążków
- RUS Съёмник штанг
- CZ Stahováky táhel řízení
- H Rúdlehúzó
- RO Ancore pt. tije
- F Set d'extracteurs pour rotules de direction
- I Set tiranti per estrattore
- E Tensores para palancas
- CN 球头拉拔器组套

6  
PCS



BMC  
& COLOR  
SLEEVE



|   |   |
|---|---|
| <b>YATO</b>  |  |
| YT-06157  | 4   |

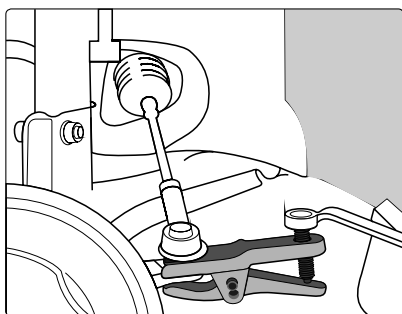

- GB Tie rod / ball joint tool kit
- D Werkzeugsatz für Bremssattel
- PL Ściągacze do drążków
- RUS Съёмник штанг
- CZ Stahováky táhel řízení
- H Rúdlehúzó
- RO Ancore pt. tije
- F Set de leviers à tête réglable
- I Set di estrattori perni e tiranti sterzo
- E Tensores para palancas
- CN 球头拉拔器组套

for / dla: YT-0990



5  
PCS

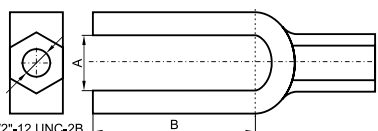
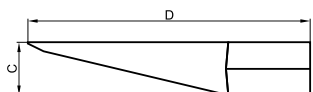
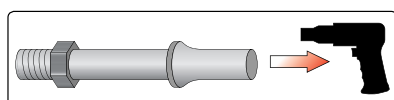
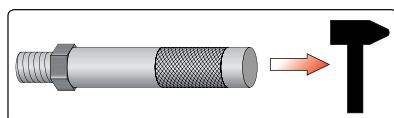

BMC  
& COLOR  
BOX



1/2"-12 UNC-2B

| <b>YATO</b>  |     | A (mm) | B (mm) | C (mm) | D (mm) |  |
|---|-----|--------|--------|--------|--------|---|
| YT-0616   | I   | 18.2   | 65.0   | 24.0   | 123.9  | 10  |
|   | II  | 25.2   | 67.8   |        |        |   |
|   | III | 30.2   | 56.3   |        |        |   |

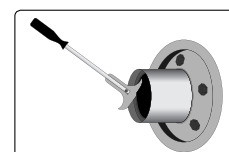

- GB Seal puller
- D Dichtungs-Abziehwerkzeug
- PL Ściągacz do uszczeltek
- RUS Съёмник прокладок
- CZ Škrabka na těsnění
- H Tömítéslehúzó
- RO Ancoră pt. garnituri
- F Outil pour extraire les joints
- I Estrattore per guarnizioni
- E Tensor para juntas
- CN 密封圈拉拔器



max. Ø  
85 mm



SLIDING  
CARD

|   |        |   |
|---|--------|---|
| <b>YATO</b>  | L (mm) |  |
| YT-0642   | 200    | 12/48   |

- GB Bearing race and seal driver set
- D Presssatz für sicherungsringe, lager, etc.
- PL Zestaw do osadzania łożysk i uszczelniaaczy
- RUS Втулка и набор сальниковых уплотнителей для автомобиля
- CZ Sada na montáž gufer
- H Csapágy, szimering, persely ki- és beütő készlet
- RO Set pt. inlocuit rulment, simering
- F Set de simerings
- I Set di tamponi per cuscinetti e guarnizioni
- E Jugeo de conductores del anillo y del sello de rodadura
- CN 斜型培令套安装器

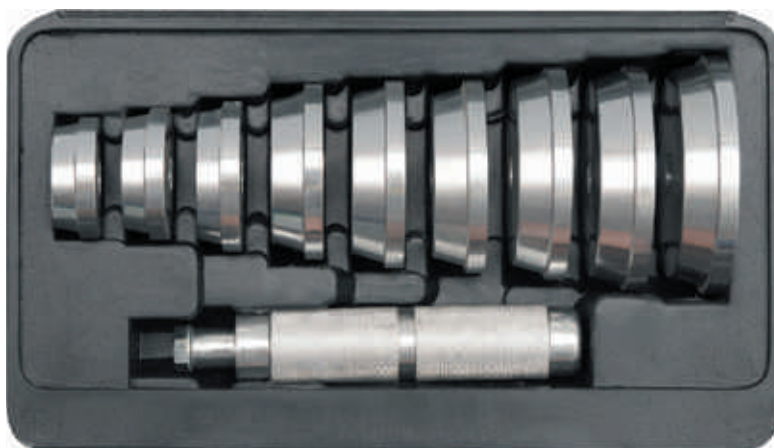

10  
PCS

AI

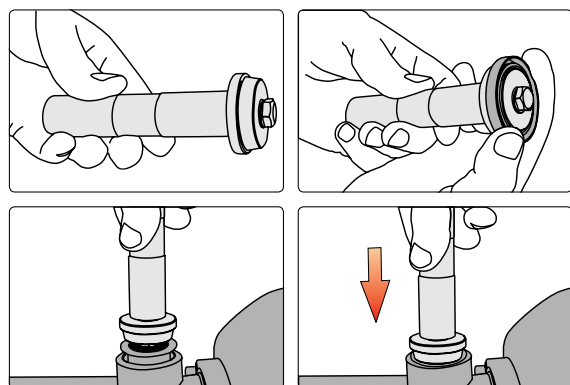

BMC  
& COLOR  
SLEEVE



| YATO    | No. | Ø (mm) |      |
|---------|-----|--------|------|
| YT-0638 | 01  | 40     | 5/10 |
|         | 02  | 44     |      |
|         | 03  | 50     |      |
|         | 04  | 59     |      |
|         | 05  | 63     |      |
|         | 06  | 65     |      |
|         | 07  | 72     |      |
|         | 08  | 76     |      |
|         | 09  | 81     |      |

- GB Car radio removal tool set
- D Autoradio Demontage Werkzeugsatz
- PL Zestaw do demontażu radioodbiorników samochodowych
- RUS Набор для разборки авто-ресиверов
- CZ Sada k demontáži autorádii
- H Autórádió kiserelő készlet
- RO Trusa de scule pt. indepartat radio
- F Set d'outils pour dépose autoradio
- I Set estrattori per autoradio
- E Jugeo para el desmontaje de autorradio
- CN 收音机拆卸组套

SLIDING  
CARD



36  
PCS

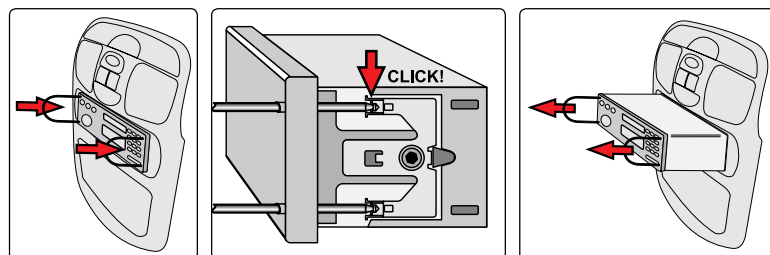
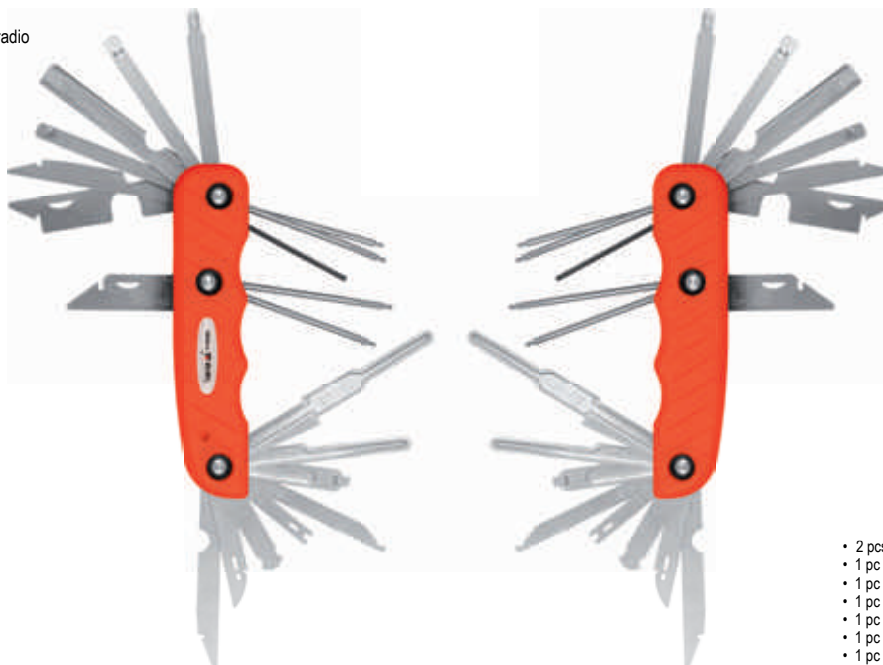

- 2 pcs P-01 Mercedes Benz, VW, Audi, Becker
- 1 pc P-02 Mercedes Benz, Porsche, Becker
- 1 pc P-03 VW
- 1 pc P-04 Skoda
- 1 pc P-05 Becker
- 1 pc P-07 Clarion
- 1 pc P-08 Kenwood
- 1 pc P-09 Sony
- 1 pc P-10 Kenwood
- 1 pc P-11-1 - Fiat Bravo, Fiat Brava
- 1 pc P-11-2 - Fiat Bravo, Fiat Brava
- 1 pc P-12 - Pioneer, JVC
- 1 pc P-13 - Panasonic
- 1 pc P-14 - Panasonic
- 1 pc P-15 - Sony
- 1 pc BMW
- 1 pc BMW, Opel
- 2 pcs Opel, Grundig, Blaupunkt
- 2 pcs VW, Audi, Ford

|          |       |
|----------|-------|
| YATO     |       |
| YT-08380 | 12/24 |



- GB Car radio removal tool set  
GB Car radio removal tool set  
D Autoradio Demontage Werkzeugsatz  
PL Zestaw do demontażu radiodbiorników samochodowych  
RUS Набор для разборки авто-ресиверов  
CZ Sada k demontáži autorádií  
H Autórádió kiserelő készlet  
RO Trusa de scule pt. indepartat radio  
F Set d'outils pour dépose autoradio  
I Set estrattori per autoradio  
E Juego para el desmontaje de autorradio  
CN 收音机拆卸组套

- 2 radio removal U-hook (Ford, VW, Audi, Grundig, Blaupunkt)
- 1 special pentagon wrench (BMW)
- 4 radio removal keys (VW, Audi, Becker, Mercedes)
- 2 radio removal keys (Mercedes, Porsche, Becker)
- 2 radio removal keys (VW)
- 1 allen hex wrench (BMW, Opel)
- 2 radio removal keys (new Becker)
- 2 radio removal keys (new Skoda)
- 2 radio removal keys U-hook (new Blaupunkt)
- 2 radio removal keys (Fiat Brava)
- 2 radio removal U-hook (Opel Doppel-Kugel-Inbus)
- 6 radio removal keys (Mercedes-Benz, BMW)
- 2 radio removal keys (Kenwood II 1998-2001)
- 2 radio removal keys (Sony II since 2002)
- 2 radio removal keys (Kenwood III since 2002)
- 2 radio removal keys (Pioneer, JVC)
- 2 radio removal keys (Sony I until 2001)
- 2 radio removal keys (Panasonic)
- 2 radio removal keys (Kenwood I until 1998)
- 2 radio removal keys (Kenwood mask)
- 2 radio removal keys (new Clarion)
- 2 radio removal keys (old Clarion)
- 2 radio removal keys (Panasonic 2006)
- 2 radio removal keys (Sony IDIC 2005)

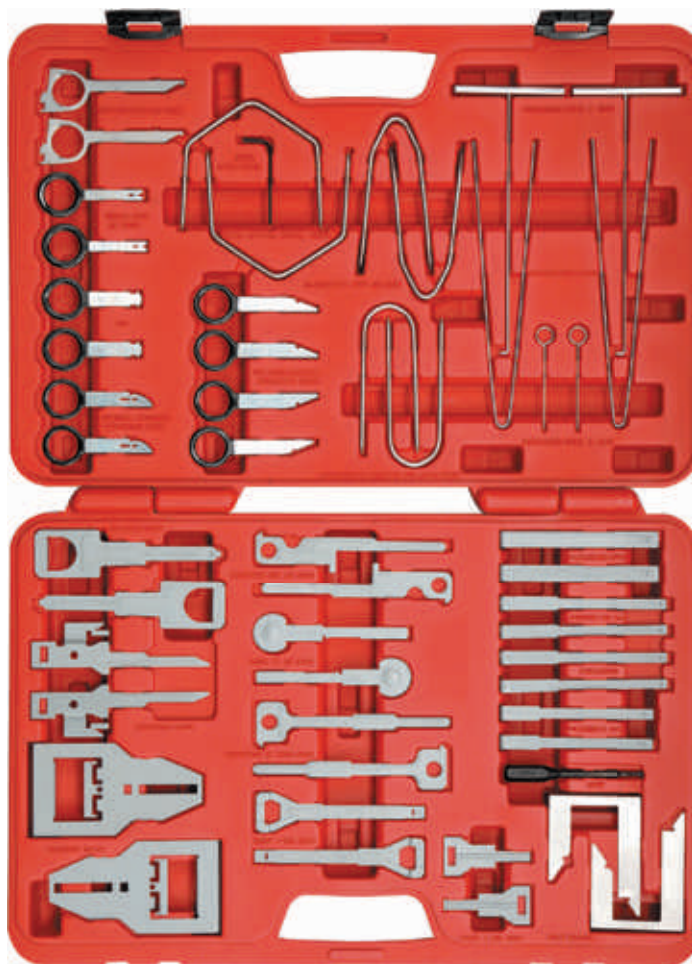

52  
PCS

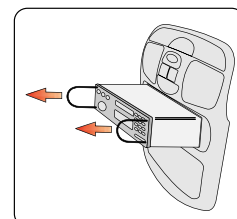
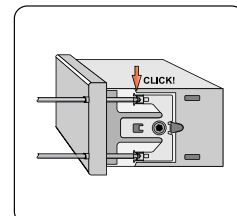
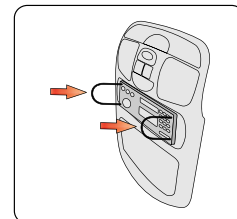

BMC  
& COLOR  
SLEEVE



|             |    |
|-------------|----|
| <b>YATO</b> |    |
| YT-0838     | 10 |

- GB Emergency automotive lock-out tool set  
D Werkzeugsatz zum Öffnen der Autotür im Notfall  
PL Zestaw do awaryjnego otwierania drzwi samochodowych  
RUS Набор для аварийного відкриття автомобільних дверей  
CZ Souprava k nouzovému otevření dveří automobilů  
H Személygépkocsi ajtó vésznyitó készlet  
RO Set pt. deschiderea de avanie a ușilor de mașină  
F Set ouverture de porte fermée  
I Set estrattori per apertura automotore  
E Juego de herramientas para abrir las puertas de coche en casos de urgencia  
CN 车门锁拆卸工具



9  
PCS

STAINLESS  
STEEL  
STAL  
NIERZEWA

PVC

16

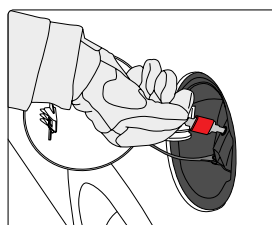
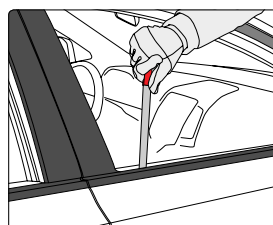
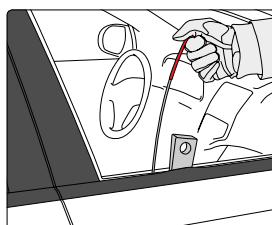
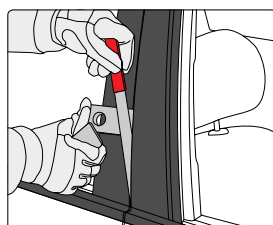

POUCH



|             |    |
|-------------|----|
| <b>YATO</b> |    |
| YT-08385    | 25 |



- GB Universal terminal release tool set
- D Werkzeugsatz für Konektorverbindungen
- PL Zestaw do złączy konektorowych
- RUS Комплект для коннекторных разъемов
- CZ Souprava na konektorové spojky
- H Szerszámkészlet konnektoros csatlakozásokhoz
- RO Set pt. cuplări conectoare
- F Set de pinces pour serrer les connecteurs
- I Set di connettori
- E Juego para conexiones de aflojamiento rápido
- CN 端子拆卸器组

12  
PCS

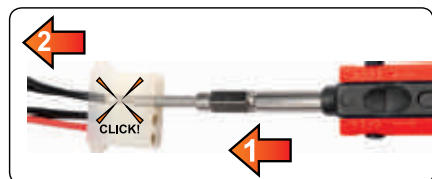

BMC  
& COLOR  
SLEEVE



| YATO     | No.      | description / opis  | application / zastosowanie   |    |
|----------|----------|---|--|----|
| YT-08430 | CE-01+11 | ejection tools for contact sizes Ø 1.5 mm w/dismantling sleeves for contact sizes<br>narzędzie do odłączania styków o rozmiarze Ø 1.5 mm wraz z tuleją do demontażu | BMW, Daimler Chrysler, Fiat, MAN, Opel, Porsche, Seat, Skoda, VW, Audi               | 10 |
|          | CE-02+12 | ejection tools for contact sizes Ø 3.5 mm w/dismantling sleeves for contact sizes<br>narzędzie do odłączania styków o rozmiarze Ø 3.5 mm wraz z tuleją do demontażu | BMW, Daimler Chrysler, Fiat, MAN, Opel, Porsche, Seat, Skoda, VW, Audi               |    |
|          | CE-05+15 | ejection tools for contact sizes Ø 2.3 mm w/dismantling sleeves for contact sizes<br>narzędzie do odłączania styków o rozmiarze Ø 2.3 mm wraz z tuleją do demontażu | Ford, Opel, PSA, Renault   |    |
|          | CE-53    | cable extractor tool for plugs with one release channel 2.8 and 5.8 mm<br>wykręтак do przewodów z pojedynczym złączem 2.8 i 5.8 mm                                  | BMW, Daimler Chrysler, Ford, MAN, Opel, Porsche, PSA, Renault, Seat, Skoda, VW, Audi |    |
|          | CE-56    | cable extractor tool for Microtimer II, III contacts Ø 1.6 mm<br>wykręтак do przewodów Microtimer II, III styki Ø 1.6 mm  | Daimler Chrysler, Opel, Porsche, PSA, Renault, Saab, Seat, Skoda, VW, Audi           |    |
|          | CE-59    | cable extractor tool for Maxipower Timer contacts 9.5 mm<br>wykręтак do styków Maxipower Timer 9.5 mm   | Daimler Chrysler, VW, Audi   |    |
|          | CE-62    | cable extractor tool for Pit-Pod contacts<br>wykręтак do styków Pit-Pod   | all vehicles<br>wszystkie pojazdy  |    |
|          | CE-74    | cable extractor tool for Microtimer I contacts and ABS plug-in housing Ø 1.6 mm<br>wykręтак do styków Microtimer I i osłony wtyku ABS Ø 1.6 mm                      | Fiat, Ford, Mazda, Opel, PSA, Renault, Saab, VW, Audi                                |    |
|          | CE-91    | cable extractor tool for plugs with two release channels 2.8 and 5.8 mm<br>wykręтак do przewodów z podwójnym złączem 2.8 i 5.8 mm                                   | BMW, Daimler Chrysler, Fiat, Ford, MAN, Opel, PSA, Renault, Saab, VW, Audi           |    |

- GB Airbag removal tool set
- D Schlüssel zur Demontage des Luftkissen
- PL Klucze do demontażu poduszki powietrznej
- RUS Набор ключей для демонтажа подушки безопасности
- CZ Klíče na demontáž airbagu
- H Kulcsok légszák leszereléséhez
- RO Chei pt. demontare airbag
- F Kit outils speciaux airbag
- I Set chiavi per smontaggio airbag
- E Llaves para desmantelamiento de bolsas de aire
- CN 安全气囊拆卸组套

16



12  
PCS

HRC  
45-50

CrV  
6150

BMC  
& COLOR  
SLEEVE



for / dla: BMW, Audi, Opel, Renault, Mercedes, VW Passat, VW Polo, VW Lupo, VW Golf 4, VW Beetle, VW Jetta, VW Bora, Seat, Skoda Fabia, Skoda Octavia



YATO  
YT-06291 10





- GB Door upholstery remover  
D Abziehvorrichtung für Polstererklammern  
PL Ściągacz do spinek tapicerki  
RUS Съёмник крепежа обивки  
CZ Uvolňovač čalounění dveří
- H Kárpitkiszedő  
RO Dispozitiv de scoas agrafe de tapiterie  
F Arrache agrafes  
I Estrattore per la rimozione di graffette tappezzeria
- E Extractor de grasas de vestidura  
CN 胶扣起子



SVCM





| YATO  | size / rozmiar (mm) |  |
|--|---------------------|---|
| YT-1370  | 6x100               | 12/120  |

| YATO  | size / rozmiar (mm) |  |
|--|---------------------|---|
| YT-1371  | 6.2x115             | 12/120  |





| YATO  | size / rozmiar (mm) |  |
|--|---------------------|---|
| YT-1372  | 10x115              | 12/120  |

| YATO  | size / rozmiar (mm) |  |
|--|---------------------|---|
| YT-1373  | 9.5x134             | 6/96  |

- GB Scratch awl  
D Einfache Spicknadel  
PL Szpikulec prosty
- RUS Прямое остриё  
CZ Šídlo rovné  
H Spékélotű, egyenes
- RO Dorn perforare drept  
F Brochette droite  
I Punteruolo piatto
- E Punzón recto  
CN 锥子

SVCM



| YATO  | L (mm) |  |
|--|--------|---|
| YT-1374  | 120    | 12/120  |



- GB Hook bodkin  
D Hakenspicknadel  
PL Szpikulec hakowy
- RUS Крюковое остриё  
CZ Šídlo háčkové  
H Spékélotű, horgos
- RO Dorn perforare indoit  
F Brochette coudée  
I Gancio punteruolo
- E Punzón encorvado  
CN 油封拉拔器



SVCM



45°

90°



| YATO  | L (mm) |  |
|--|--------|---|
| YT-1376  | 90     | 12/120  |

| YATO  | L (mm) |  |
|--|--------|---|
| YT-1375  | 125    | 12/120  |

- GB Battery cap tool  
D Abziehvorrichtung für Akkuklemmen  
PL Ściągacz do klemm akumulatora  
RUS Стяжка для клемм аккумулятора  
CZ Stahovák svorek akumulátoru  
H Akkumulátor saru lehzó  
RO Extractor pt. cleme accumulator
- F Tournevis plat pour bouchons de batterie  
I Batteria clem estrattore  
E Extractor para los bornes de la batería  
CN 扁铲

SVCM









| YATO  | size / rozmiar (mm) |  |
|--|---------------------|---|
| YT-1378  | 18.5x100            | 12/120  |



- GB Glass scraper  
D Scheibenkratzer  
PL Skrobak do szyb  
RUS Шабер для стекла
- CZ Škrabka na okna  
H Jégkaparó  
RO Răzuitor geamuri  
F Gratteur pour vitres
- I Raschietto per vetro  
E Rascador para los vidrios  
CN 刮刀

SVCM



| YATO  | size / rozmiar (mm) |  |
|--|---------------------|---|
| YT-1379  | 39x200              | 6/72  |

- GB Spare blades for glass scraper  
D Abbrechklängen  
PL Ostrze do skrobaka do szyb  
RUS Лезвия для универсальных ножей  
CZ Lomené ostří náhradní  
H Törhető tartalékpenge  
RO Lame de rezervă rupte  
F Lames pour gratteur pour vitres  
I Lame per raschietto  
E Filo partido de recambio  
CN 刮刀片
- COLOR BOX 
- 10 PCS  SK5 
- for / dla: YT-1379
- 

| YATO  | size / rozmiar (mm) |  |
|--|---------------------|---|
| YT-13790   | 19x39               | 50  |



- GB Flexible spinner handle  
D Elastischer Dreher  
PL Pokrętko elastyczne  
RUS Эластичный вороток
- CZ Šroubovák ohebný  
H Hajlékony csavarhúzó  
RO Măner flexibil  
F Barre élastique
- I Chiave flessibile  
E Llave flexible  
CN 套筒螺丝批

1/4"

6.3mm

SVCM



| YATO  | size / rozmiar         |  |
|--|------------------------|---|
| YT-1381  | 1/4" (6.3 mm) x 150 mm | 6/96  |

GB Flexible magnetic bit driver  
 D Elastischer Dreher für Bits  
 PL Pokrętko elastyczne do bitów  
 RUS Эластичный вороток для разряда битов

CZ Šroubovák ohebný na bity  
 H Hajlékony csavarhúzó bit  
 RO Mâner flexibil pt. vârf șurubelniță  
 F Barre élastique

I Chiave flessibile  
 E Mango flexible para desarmadores  
 CN 批头螺丝批

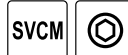

| YATO    | size / rozmiar         |      |
|---------|------------------------|------|
| YT-1382 | 1/4" (6.3 mm) x 380 mm | 6/72 |

GB Flexible magnetic pick up tool  
 D Elastische Magnethalterung  
 PL Elastyczny uchwyt magnetyczny  
 RUS Эластичный магнитный держатель

CZ Ohebný magnetický držák  
 H Hajlékony mágneses szár  
 RO Mâner magnetic flexibil  
 F Capteur magnétique

I Chiave flessibile  
 E Mango magnético flexible  
 CN 拾拾器



| YATO    | L (mm) |      |
|---------|--------|------|
| YT-1385 | 400    | 6/72 |

GB Flexible hose clip screwdriver  
 D Steckschlüssel, elastisch  
 PL Klucz nasadowy elastyczny  
 RUS Эластичный торцевой ключ

CZ Klíč nástrčný ohebný  
 H Hajlékony dugókulcs  
 RO Cheie tubulara flexibil  
 F Clé à tube élastique

I Chiave a tubo flessibile  
 E Llave de tubo flexible  
 CN 螺帽螺丝批



| YATO    | size / rozmiar (mm) |      |
|---------|---------------------|------|
| YT-1390 | 6x150               | 6/96 |



| YATO    | size / rozmiar (mm) |      |
|---------|---------------------|------|
| YT-1391 | 7x150               | 6/96 |



| YATO    | size / rozmiar (mm) |      |
|---------|---------------------|------|
| YT-1392 | 8x150               | 6/96 |

16

GB Hook screwdriver  
 D Winkelschraubendreher  
 PL Wkrętkak kątowy  
 RUS Отвёртка

CZ Šroubovák  
 H Csavarhúzó  
 RO Șurubelniță  
 F Tournevis coudé

I Cacciavite angolare  
 E Destornillador  
 CN 螺丝批钩子

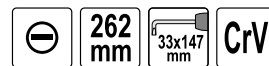

| YATO     | PCS packing |        |
|----------|-------------|--------|
| YT-28480 | 6 12        | 36/144 |

GB Door upholstery remover  
 D Abziehvorrichtung für Polstererklammern  
 PL Ściągacz do spinek tapicerki  
 RUS Съемник крепежа обивки

CZ Uvolňovač čalounění dveří  
 H Kárpitkiszedő  
 RO Dispozitiv de scos agrafe de tapiterie  
 F Spatule d'extraction de clips

I Estrattore per la rimozione di graffette tappezzeria  
 E Extractor de grapas de vestidura  
 CN 胶扣起子

SLIDING CARD



| YATO    | L (mm) |       |
|---------|--------|-------|
| YT-0841 | 230    | 16/64 |



| YATO    | L (mm) |        |
|---------|--------|--------|
| YT-0842 | 200    | 25/100 |



- GB Panel removal set  
D Abziehvorrichtung für Polsterung  
PL Ściągacze do tapicerki  
RUS Съёмник обивки  
CZ Sada k demontáži čalounění  
H Kárpitlehúzó  
RO Ancore pt. tapiterie  
F Set d'extracteurs à la tapisserie  
I Leve in plastica per la tappezzeria  
E Tensores para las vestiduras  
CN 面板拆卸组套

DOUBLE  
BLISTER



IMPACT  
RESISTANT  
NYLON  
ODPORNE  
NA UDARZENIA  
NO SCRATCH  
BEZ  
ZADRAPAN

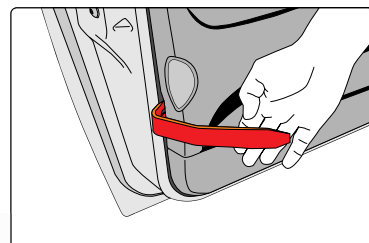

5  
PCS

6  
PCS



|             |      |
|-------------|------|
| <b>YATO</b> |      |
| YT-0836     | 6/24 |

|             |      |
|-------------|------|
| <b>YATO</b> |      |
| YT-0837     | 6/24 |

- GB Panel removal set  
D Abziehvorrichtung für Polsterung  
PL Ściągacze do tapicerki  
RUS Съёмник обивки  
CZ Sada k demontáži čalounění  
H Kárpitlehúzó  
RO Ancore pt. tapiterie  
F Set d'extracteurs à la tapisserie  
I Leve in plastica per la tappezzeria  
E Tensores para las vestiduras  
CN 面板拆卸组套

POUCH  
& COLOR  
BOX



11  
PCS

- GB Set of plastic scrapers  
D Satz von Kunststoffschabern  
PL Zestaw skrobaków plastikowych  
RUS Набор пластмассовых шпателей  
CZ Souprava plastových škrabek  
H Műanyag vakaró készlet

- RO Set de răzuitoare din plastic  
F Kit de grattoirs en plastique  
I Set di raschietto  
E Juego de rascadores de plástico  
CN 塑料刮刀

4  
PCS

265  
mm

IMPACT  
RESISTANT  
NYLON  
ODPORNE  
NA UDARZENIA  
NO SCRATCH  
BEZ  
ZADRAPAN



|             |      |
|-------------|------|
| <b>YATO</b> |      |
| YT-0844     | 5/10 |



SLIDING  
CARD



|             |        |      |
|-------------|--------|------|
| <b>YATO</b> | L (mm) |      |
| YT-0847     | 265    | 6/36 |

- GB Multiposition pry bar set  
D Steckschlüsselsatz mit regulierbaren Kopfstück  
PL Zestaw dźwigni z regulowaną główką  
RUS Комплект рычагов с регулируемой головкой

- CZ Sada páčidel s nastaviteľnou hlavou  
H Szabályozható fejű emelőkar készlet  
RO Set de leviere cu cap reglabil  
F Set de leviers à tête réglable

- I Set leva con testa orientabile  
E Juego de palancas con cabeza ajustable  
CN 多用途撬棒组套

3  
PCS

10"  
250mm

12"  
300mm

15"  
380mm

22mm

LOCK  
SYSTEM  
SYSTEM  
BLOKADY

CrV



BMC  
& COLOR  
SLEEVE



|             |    |
|-------------|----|
| <b>YATO</b> |    |
| YT-06161    | 10 |

- GB Quick release cut out tool
- D Schneidmesser für Scheiben
- PL Nóż do wycinania szyb
- RUS Нож для вырезания стекол
- CZ Nůž na vyřezávání skel
- H Szélvédőkívágó kés
- RO Cuțit tăietor de geam
- F Kit de découpe pare-brise
- I Tagliolo per il vetro
- E Cuchilla para cortar cristales
- CN 玻璃橡胶刮除器



**3x**  
BLADES  
OSTRZA

**Alu**  
HANDLE  
UCHWYT

**QUICK**  
RELEASE  
SZYBKO-  
ZŁACZE

**K5**

SLIDING  
CARD



- GB Spare blades for cut out tool
- D Abbrechklingenn
- PL Ostrza zapasowe do noża do wycinania szyb
- RUS Лезвия для ножей
- CZ Ostrí náhradní
- H Törhető tartalékpenge
- RO Rezerve cutter
- F Lames
- I Lama di ricambio per coltello specialistica per tagliare vetri del auto
- E Filo partido de recambio
- CN 玻璃橡胶刮除器刀片



**3x**  
BLADES  
OSTRZA

**K5**

for / dla: YT-0659

SLIDING  
CARD



3/4" (19 mm);  
1" (25 mm);  
1-1/2" (38 mm)

**YATO**  
YT-0659  20/40

**YATO**  
YT-06590  10/80

- GB Windshield removal set
- D Demontagesatz für Autoscheiben
- PL Zestaw do demontażu szyb samochodowych
- RUS Набор для демонтажа автостекла
- CZ Souprava na demontáž autoskel
- H Szélvédőcsereológ szett
- RO Set pt. demontarea geamurilor de mașină
- F Kit pour démontage de vitres de voiture
- I Set di strumenti di rimozione parabrezza
- E Juego para desmontaje de cristales de coches
- CN 风挡玻璃拆卸组套



**7**  
PCS

**HRC**  
38-42

COLOR BOX



**YATO**  
YT-0845  10

- GB Windscreen wiper arm removal tool
- D Abziehvorrichtung für die Scheibenwischerarme
- PL Ściągacz do ramion wycieraczek
- RUS Съемник поводков стеклоочистителя
- CZ Stahovák na ramínka stěračů
- H Ablaktörökár lehűző
- RO Siguranță pt. brațele ștergătoarelor
- F Bord aux bras d'essuie-glace
- I Estrattore di parabrezza tergicristallo braccio
- E Herramienta para desmontaje de las plumas de los limpiaparabrisas
- CN 雨刷臂拆卸工具

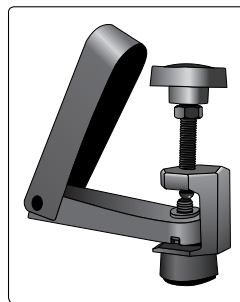

SLIDING  
CARD



**YATO**  
YT-0846  12/120

- GB Air condition repair set
- D Schlüsselsatz für die Klimatisierung
- PL Zestaw kluczy do klimatyzacji
- RUS Набор ключей для кондиционеров
- CZ Sada klíčů na klimatizace
- H Kulcskészlet légkondicionáléhoz
- RO Set de chei pt. aer conditionat
- F Set de clés pour climatisation
- I Set di chiavi per l'aria condizionata
- E Juego de llaves para los sistemas de aire acondicionado
- CN 空调维修工具组套







**12**  
PCS

**1/4"**  
6.3mm

FOR A/C  
DO KLIMA-  
TYZACJI

**CrV** **S2**

**8 POINTS**  
**8 PUNKTÓW**

-  1/4" (6.3 mm); 2.2 mm, 3.2 mm; CrV;
-  1/4" (6.3 mm); 12 mm, 15 mm; CrV;
-  1/4" (6.3 mm); CrV;
-  1/4" (6.3 mm); TS10, TS15, TS20, TS25, TS27, TS30, TS40 (L=25 mm); ALSI S2

BMC  
& COLOR  
SLEEVE



**YATO**  
YT-06271  10/40



- GB CV boot clamp pliers  
D Zange für Schellen der Gelenkabdeckung  
PL Szczypce do oprasek osłony przegubu  
RUS Щипцы для хомутов крепления кожуха шарнира  
CZ Kleště na spony manžety kloubu  
H Féltengely bilincs húzó fogó  
RO Clește pt. brățară de husă la articulație  
F Pince pour collier à recouvrement de joint  
I Pinza a morsetto per fascette pinzabili  
E Alicates para abrazadera de protección de la junta  
CN 夹紧钳

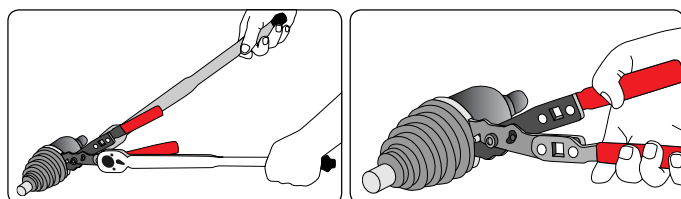

|             |        |      |
|-------------|--------|------|
| <b>YATO</b> | L (mm) |      |
| YT-0606     | 235    | 6/36 |

- GB Lock-ring pliers  
D Spreizzange für Schellen  
PL Szczypce rozporowe do pierścieni osadczyc  
RUS Щипцы распорные для стяжных хомутов  
CZ Kleště na hadicové spony  
H Seeger fogó  
RO Clește pt. desfacerea brățarelor de strângere  
F Pince tenaille pour les bagues de retenue  
I Pinza per rondelle elastice scanalata  
E Alicates para abrazaderas  
CN C 型扣钳

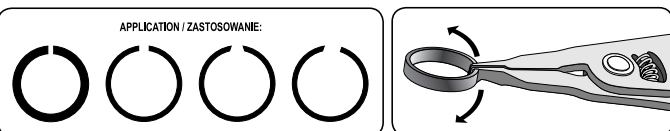

|             |        |       |
|-------------|--------|-------|
| <b>YATO</b> | L (mm) |       |
| YT-0607     | 225    | 12/72 |

- GB Transmission line disconnect tool set  
D Werkzeugsatz zum Trennen von Kraftstoffleitungen  
PL Zestaw do rozłączania przewodów  
RUS Набор для рассоединения топливopроводов  
CZ Sada na rozpojování palivového potrubí  
H Üzemanyagsó-lebontó készlet  
RO Set pt. deconectarea liniilor de combustibil  
F Set pour disjoindre des câbles  
I Set per scollegare i tubi di carburante  
E Juego para desconectar conductos de combustible  
CN 油管拆卸组套



8 PCS  
**FOR A/C**  
DO KLIMATYZACJI  
**FOR FUEL LINE**  
DO PRZEWODÓW PALIWA

BMC & COLOR SLEEVE



- GB Fuel feel pipe pliers  
D Zange für Tankverschlüsse  
PL Szczypce do złączek paliwowych  
RUS Щипцы для топливных соединений  
CZ Kleště na spojky palivového systému  
H Üzemanyagvezeték fogó  
RO Clește pt. conectoare de combustibil  
F Pince tenaille pour connecteurs de carburant  
I Pinza per tubo carburante  
E Alicates para enchufes de combustible  
CN 油管钳

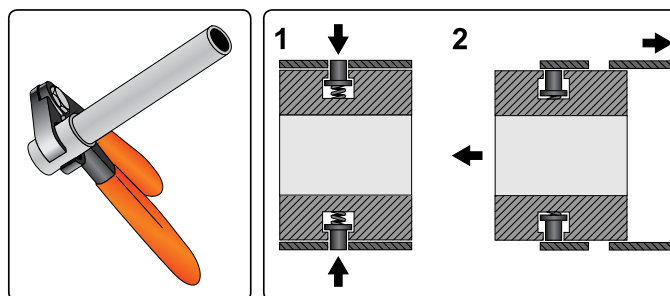

|             |        |       |
|-------------|--------|-------|
| <b>YATO</b> | L (mm) |       |
| YT-0608     | 235    | 10/40 |

- GB Hose removing pliers  
D Schlauch- und Kabellösezange  
PL Szczypce do zdejmowania przewodów  
RUS Клещи для снятия изляции  
CZ Kleště na demontáž hadic  
H Tömlőbilincs fogó  
RO Clește pt. indepartat furtune  
F Pince pour enlever les fils  
I Pinza spelacavi universale  
E Alicates de extracción de mangueras  
CN 油管分离钳



|             |        |      |
|-------------|--------|------|
| <b>YATO</b> | L (mm) |      |
| YT-0657     | 225    | 6/36 |

|             |        |    |
|-------------|--------|----|
| <b>YATO</b> | L (mm) |    |
| YT-0630     | 225    | 20 |



- GB Spark plug puller set VAG
- D Abzieher-Satz Zündspulen VAG
- PL Zestaw ściągaczy do świek zapłonowych VAG
- RUS Набор съёмников для катушек зажигания VAG
- CZ Sada stahováků zapalovací cívký
- H Gyújtótekercs lehúzó készlet
- RO Set bobina de aprindere tragator
- F Set d'extracteurs des bobines d'allumage
- I Set per la rimozione rapida bobine di accensione nelle auto VAG
- E Extractores bobinas de encendido grupo VAG
- CN 四件套火花塞维修工具

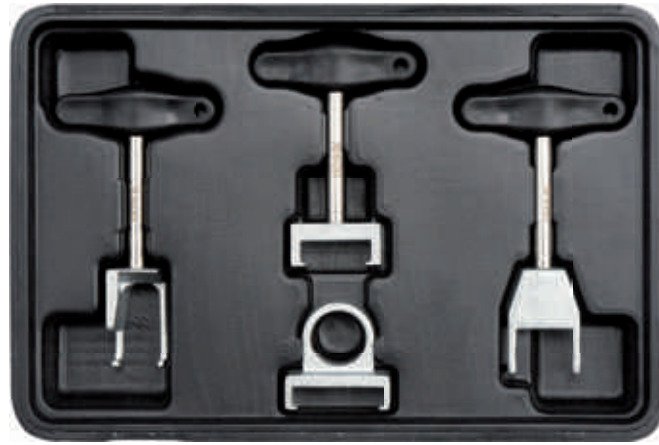

4  
PCS  
FOR / DLA  
VAG.

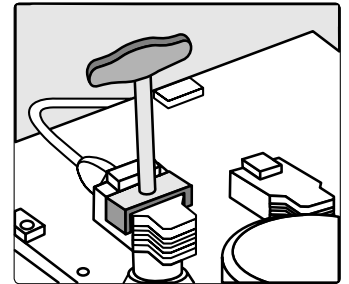

for / dla: VW, Audi, Skoda, Seat

| YATO     |          |  |  |    |
|----------|----------|--|--|----|
| YT-06205 | T type 1 |  | Volkswagen FSI Golf / Bora 1998, Polo 2002, Touran 2004, New Beetle 2003, Passat 1997, T4+Audi A2 2001   | 10 |
|          | T type 2 |  | Silniki/engines 6 cyl. 24V, 5 cyl, Golf / Bora 1998, Passat / Touareg 1997, Sharan 1996, Phaeton / Toureg 6 cyl. 2003, T5 z 6 cyl. silnikami 2004            |    |
|          | T type 3 |  | Volkswagen silnik / engines 2.0 z bezp. wtrysk / direct injection, Touran 2004, Passat 2006, Audi z bezp. wtrysk / direct injection A3 2.0 2004, A6 3.2 2005 |    |
|          | T type 4 |  | Volkswagen z bezp. wtrysk / direct injection 2.0, Golf / Touran 2004, Passat 2006, Audi z bezp. wtrysk / direct injection, A3 2.0 2004, A6 3.2 2005          |    |

- GB Spark plug terminal pliers
- D Zange für das Zündkerzenkabel
- PL Szczypce do przewodów świec zapłonowych
- RUS Щипцы к проводам свечей зажигания
- CZ Kleště na kabely zapalovacích svíček
- H Gyújtógyertya-kábel fogó
- RO Clește pt. conductele bujiilor de aprindere
- F Pince pour fils d'allumage
- I Pinze per candele
- E Pinzas para los cables de las bujías de ignición
- CN 火花塞高压线钳

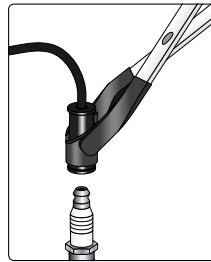

200  
mm  
255  
mm



| YATO    | L (mm) |       | YATO    | L (mm) |       |
|---------|--------|-------|---------|--------|-------|
| YT-0639 | 200    | 12/96 | YT-7320 | 255    | 10/60 |

16

- GB Multi-purpose hose & wire pliers
- D Zangensatz für Schellen und Leitungen
- PL Komplet szczypiec do opasek i przewodów
- RUS Набор щипцов к хомутам и проводам
- CZ Souprava kleští na spony a hadice
- H Fogókészlet bilincsekhez és vezetékhez
- RO Set clește pt. benzi și conducte
- F Pince pour collier de serrage
- I Set pinze per il morsetto
- E Juego de pinzas para abrazaderas y cables
- CN 多功能管夹钳

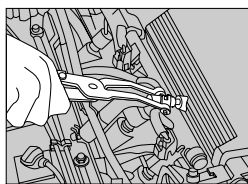

For engine air pipe  
Do przewodów powietrznych listwy wtryskowejj

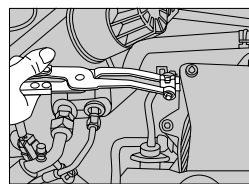

For engine intake air pipe  
Do przewodów gumowych układu zasilania

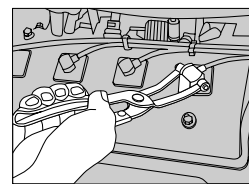

For spark plug lead  
Do przewodów zapłonowych

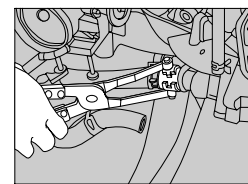

For cooling water pipe  
Do przewodów gumowych układu chłodzenia

2  
PCS  
1/4"-3/4"  
6.3-19.0  
mm



217  
mm  
254  
mm

SLIDING  
CARD



| YATO    | L (mm) |      |
|---------|--------|------|
| YT-0645 | 217    | 6/24 |
|         | 254    |      |



GB Hose clamp pliers  
D Zange zum Entspannen der Klemmschellen  
PL Szczypce do opasek zaciskowych rozprężnych  
RUS Щипцы к хомутам зажимным распорным  
CZ Kleště na samosvorné hadicové spony  
H Vízcsőbilincsfogó

RO Clește pt. benzile de strângere destindere  
F Pince pour collier de serrage  
I Set pinze per il morsetto  
E Pinzas para las abrazaderas de expansión  
CN 管夹钳

SLIDING  
CARD

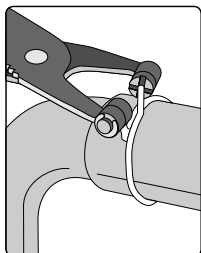
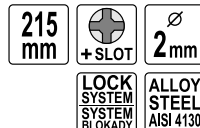

| YATO    | L (mm) |       |
|---------|--------|-------|
| YT-0646 | 215    | 12/72 |

GB Hose clamp pliers  
D Zange zum Entspannen der Klemmschellen  
PL Szczypce do opasek zaciskowych rozprężnych  
RUS Щипцы к хомутам зажимным распорным  
CZ Kleště na samosvorné hadicové spony  
H Vízcsőbilincsfogó

RO Clește pt. benzile de strângere destindere  
F Pince pour collier de serrage  
I Set pinze per il morsetto  
E Pinzas para las abrazaderas de expansión  
CN 管夹钳

SLIDING  
CARD

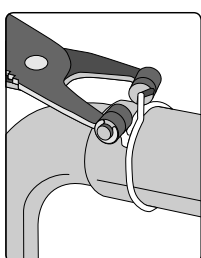
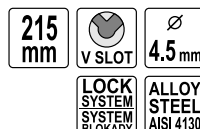

| YATO    | L (mm) |       |
|---------|--------|-------|
| YT-0647 | 215    | 12/72 |

GB Hose clamp pliers  
D Zange zum Entspannen der Klemmschellen  
PL Szczypce do opasek zaciskowych rozprężnych  
RUS Щипцы к хомутам зажимным распорным  
CZ Kleště na samosvorné hadicové spony  
H Vízcsőbilincsfogó

RO Clește pt. benzile de strângere destindere  
F Pince pour collier de serrage  
I Set pinze per il morsetto  
E Pinzas para las abrazaderas de expansión  
CN 管夹钳

SLIDING  
CARD

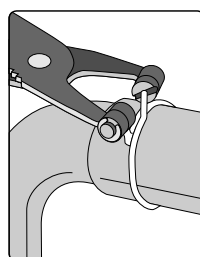
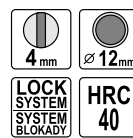

230  
mm

| YATO    | L (mm) |      |
|---------|--------|------|
| YT-0650 | 230    | 6/36 |



45°



215  
mm

| YATO    | L (mm) |      |
|---------|--------|------|
| YT-0651 | 215    | 6/36 |

GB Exhaust pipe clamp pliers  
D Auspuffschellen-Sicherungs zange  
PL Szczypce do opasek wydechu  
RUS Щипцы для пружинных зажимов  
CZ Kleště na spony výfuku  
H Kipufogóbilincsfogó

RO Clește pt. coliere teava de esapament  
F Pince pour collier d'échappement  
I Set pinze per il morsetto  
E Pinzas para bridas del tubo de escape  
CN 排气管夹钳

SLIDING  
CARD



300  
mm

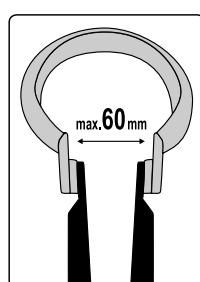

| YATO    | L (mm) |       |
|---------|--------|-------|
| YT-0652 | 300    | 10/40 |

for / dla: Peugeot, Citroën,  
Renault, Fiat, Ford

- GB Valve stem seal pliers
- D Lange Zange für Ventildichtringe
- PL Szczypce do uszczelniaczy zaworowych, długie
- RUS Щипцы для замены маслосъемных колпачков
- CZ Kleště na těsnění ventilů, dlouhé
- H Szelepszár szimering fogó hosszú

- RO Clește cu picior lung pt. sigilat supape
- F Pince pour joints de queues de soupapes
- I Pinza per tenuta anello stelo valvola
- E Pinzas para juntas de vástago válvula
- CN 气门油封钳

SLIDING CARD



**270 mm**

FOR VALVE STEM SEALS  
(DO USZCZELNIACZY ZAWOROWYCH)

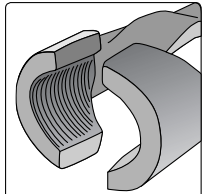

**NON-SLIP**



| YATO    | L (mm) |       |
|---------|--------|-------|
| YT-0648 | 270    | 12/60 |

- GB Pliers for band clips with a cord
- D Zange für Rohrschellen mit Seil
- PL Szczypce z linką do opasek zaciskowych
- RUS Щипцы к зажимным хомутам с тросиком
- CZ Kleště s lanekem na samosvorné hadicové spony
- H Flexibilis bowdenes vizcsőbilincs fogó
- RO Clește pt. cleme de prindere frânghie

- F Pince pour collier de serrage
- I Pinza per il montaggio e lo smontaggio delle clips elastiche
- E Pinzas para bandas de apretadura con cuerda
- CN 延长型弹性管夹钳

SLIDING CARD



**CrMo 4140**

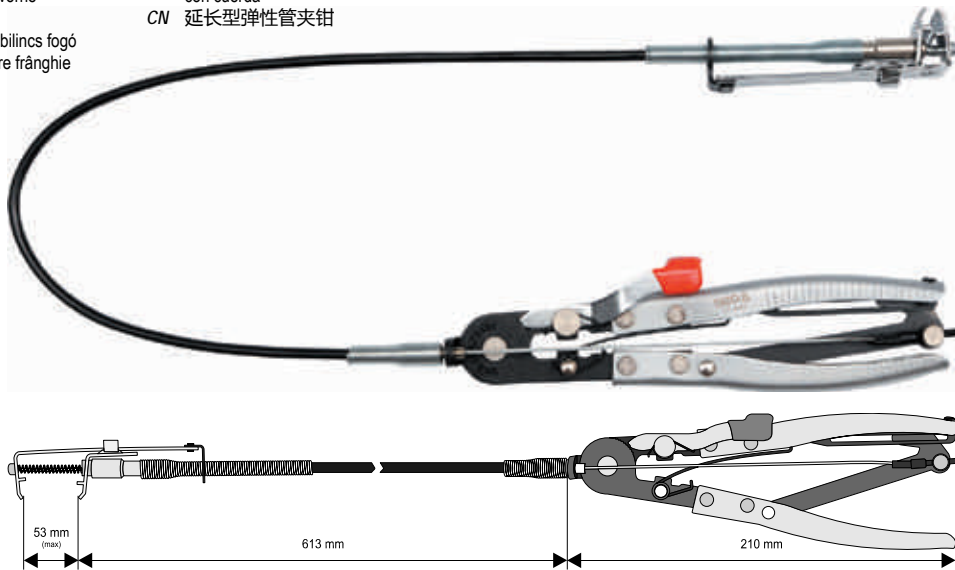

| YATO    |  |       |
|---------|--|-------|
| YT-0653 |  | 12/36 |

- GB Pliers for band clips with a cord
- D Zange für Rohrschellen mit Seil
- PL Szczypce z linką do opasek zaciskowych
- RUS Щипцы к зажимным хомутам с тросиком
- CZ Kleště s lanekem na samosvorné hadicové spony
- H Flexibilis bowdenes vizcsőbilincs fogó
- RO Clește pt. cleme de prindere frânghie

- F Pince pour collier de serrage
- I Pinza per il montaggio e lo smontaggio delle clips elastiche
- E Pinzas para bandas de apretadura con cuerda
- CN 延长型弹性管夹钳

SLIDING CARD



**CrMo 4140**

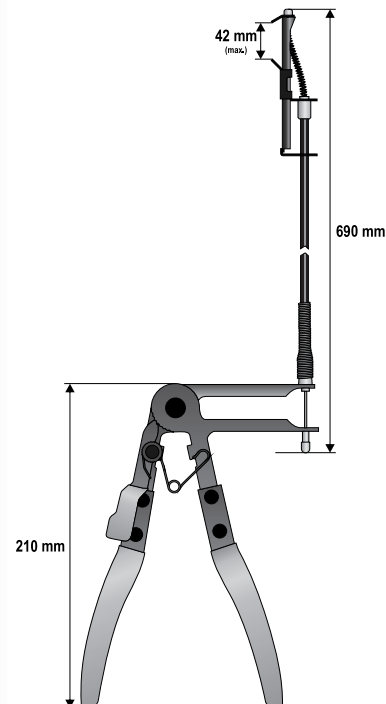

| YATO    |  |    |
|---------|--|----|
| YT-0677 |  | 25 |



- GB Hose clip pliers  
D Schlauchklemmzange  
PL Szczypce do opasek zaciskowych typu CLIC i CLIC-R  
RUS Плоскогубцы для зажима шлангов хомуты, CLIC-R  
CZ Kleště na hadicové spony  
H Tömélbilincs fogó  
RO Cleste furtun clip  
F Pince pour collier de serrage  
I Pinza per fascetta a CLIC e CLIC-R  
E Alicates abrazaderas  
CN 压线钳



SLIDING CARD



170 mm

CLIC CLIC-R

| YATO     | L (mm) |       |
|----------|--------|-------|
| YT-06475 | 170    | 15/60 |

- GB Water pump pulley locking wrench  
D Schlüssel für die Wasserpumpe  
PL Klucz do pompy wodnej  
RUS Ключ к водному насосу  
CZ Klíč na vodní čerpadlo  
H Vízpumpafogó
- RO Cheie pt. pompe de apă  
F Clé de blocage pour pompe à eau  
I Chiave per la pompa del acqua  
E Llave paral la bomba de agua  
CN 水泵皮带轮扳手

SLIDING CARD



245 mm

285 mm

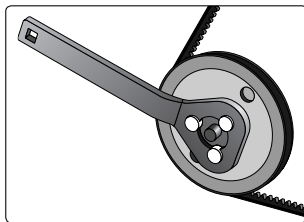

Volkswagen and Audi  
without air condition  
Volkswagen i Audi  
bez klimatyzacji



Volkswagen and Audi  
with air condition  
Volkswagen i Audi  
z klimatyzacją

| YATO    | L (mm) |      |
|---------|--------|------|
| YT-0539 | 245    | 6/36 |

| YATO    | L (mm) |      |
|---------|--------|------|
| YT-0540 | 285    | 6/36 |

- GB Tensioner pulley wrench  
D Zahnriemen Spannrollenschlüssel  
PL Klucz do rolki napinającej  
RUS Ключ для регулировки натяжного
- CZ Klíč na napínák  
H Bordás szij feszítő  
RO Cheie de pretensionare a centurilor  
F Clé pour rouleau de tension
- I Chiave per il rullo tenditore  
E Llave del tensor de la correa dentada  
CN 滑轮定时扳手

SLIDING CARD



32 mm



| YATO     |        |
|----------|--------|
| YT-06273 | 20/100 |

- GB Universal pulley holder & fan clutch set  
D Schlüssel zum Spannen  
der Riemenscheibe  
PL Klucz do napinania koła pasowego
- RUS Ключ для натягивания шкива  
CZ Klíč k napínání řemenice  
H Szijtárcsa feszítő kulcs  
RO Cheie pt. întindere roată de curea
- F Clé universelle pour poulie  
I Blocca puleggia  
E Llave tensora para polea  
CN 多带式皮带轮扳手



11 PCS

BMC & COLOR SLEEVE

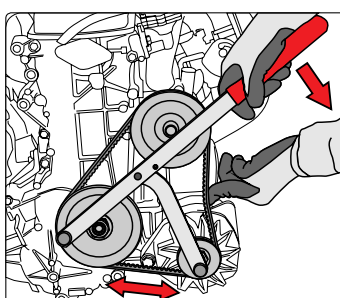

Ø 6-10 mm;  
Ø 8-11 mm;  
Ø 10-12 mm;  
Ø 11-16 mm

| YATO    |   |
|---------|---|
| YT-0627 | 8 |

GB Piston ring compressor  
 D Kolbenring-Spannband  
 PL Zaciskacz do pierścieni  
 RUS Оправка поршневых колец  
 CZ Svěrka na kroužky

H Gyűrűbepattintó  
 RO Clește pt. strâns inele  
 F Compresseur de segments de piston  
 I Morsetto per anelli

E Apretador de anillos  
 CN 活塞环压缩机

AISI #301

SK5

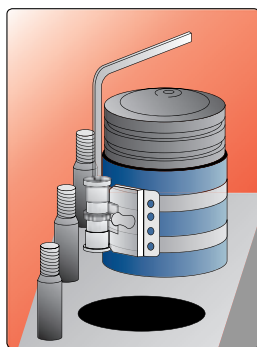

COLOR BOX

| YATO    | Ø (mm) | H (mm) | Box   |
|---------|--------|--------|-------|
| YT-0635 | 50-125 | 75     | 30/60 |
| YT-0636 | 90-175 | 100    | 30/60 |
| YT-0637 | 90-175 | 150    | 20/40 |

GB Belt gauge  
 D Werkzeug Spannungsprüfer  
 PL Przyrząd do kontroli naciągu paska rozrządu  
 RUS Прибор для проверки натяжения ремней  
 CZ Přípravek pro kontrolu napnutí rozvodového řemene  
 H Méter szíjteszességét  
 RO Tester întindere curea de distributie cu gradatie  
 F Controleur de tension de courroie  
 I Strumento per il controllo rapido della tensione cinghia distribuzione  
 E Medidor para determinar la tensión de la correa  
 CN 皮带张紧器

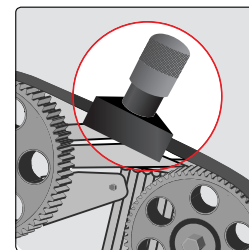

COLOR BOX

| YATO     | Box |
|----------|-----|
| YT-06019 | 20  |

GB Twin cam locking tool for petrol & diesel engines  
 D Universelle Blockade der Steuerwellen  
 PL Uniwersalna blokada wałków rozrządu  
 RUS Универсальный набор блокировки распревала  
 CZ Univerzální přípravek na zablokování rozvodných hřídelí  
 H Univerzális vezérműtengely rögzítő

RO Blocadă universală arbore de direcție  
 F Outil de blocage d'arbre à cames  
 I Universale strumento di bloccaggio a camme  
 E Bloqueo universal de eje de distribución  
 CN 双凸齿轮固定器

FOR PETROL & DIESEL ENGINES DO SILNIKÓW DIELSIA I BENZYNOWYCH

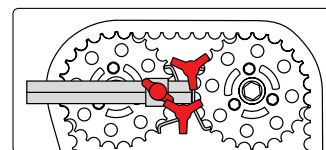

SLIDING CARD

| YATO     | Box   |
|----------|-------|
| YT-06011 | 10/20 |

16

GB Camshaft locking tool  
 D Nockenwellen-Arretierwerkzeug  
 PL Przyrząd do blokowania kół rozrządu  
 RUS Инструмент для блокирования распределительных механизмов  
 CZ Přípravek k montáži rozvodových kol  
 H Vezérlés rögzítő szerszám  
 RO Arbore cu came  
 F Outil de blocage d'arbre à cames  
 I Set di serrature di temporizzazione  
 E Aparato para bloquear el árbol de levas  
 CN 正時皮帶固定器

SLIDING CARD



48 mm

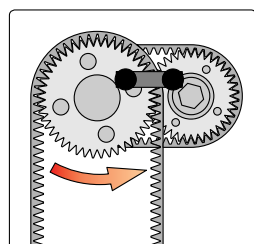

VW Lupo since 1999  
 VW Polo since 1995  
 VW Caddy since 1996  
 VW Polo Classic since 1996

VW Polo Variant since 1996  
 VW New Beetle 1.4 l  
 VW Golf 1.4 l, 1.6 l since 1998  
 VW Bora 1.4 l, 1.6 l since 1999

| YATO    | Box  |
|---------|------|
| YT-0601 | 6/36 |

GB Diesel engine locking setting kit  
 D Blockade für die Steuerräder  
 PL Blokada do kół rozrządu  
 RUS Блокировка к колесам распределительных механизмов  
 CZ Souprava na fixaci rozvodových kol  
 H Diesel motor rögzítő készlet

RO Blocadă roțiilor distribuție  
 F Outil de blocage d'arbre à cames  
 I Cinghia di distribuzione di bloccaggio  
 E Bloqueo para las poleas del mecanismo de distribución  
 CN 正时皮带更换工具

3 PCS

FOR VALVE TRAIN DO UKLADU ROZRZADU

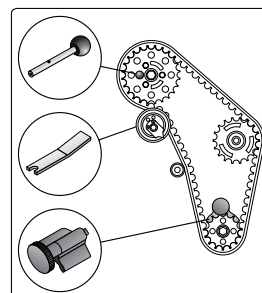

SEAT: Arosa, Ibiza, Cordoba, Leon, Toledo, Alhambra (1999-2005);  
 SKODA: Fabia, Octavia (2000-2006)  
 3 i 4 cyl 1.2, 1.4, 1.9 TDI PD  
 FORD: Galaxy (2000-2006);

SLIDING CARD



| YATO    | Box   |
|---------|-------|
| YT-0632 | 10/50 |



GB Timing locking set  
D Arretierwerkzeugsatz für Nockenwellen  
PL Zestaw blokad rozrządu  
RUS Набор блокировок к колесам  
распределительных механизмов  
CZ Blokovací sada pro opravy rozvodů  
H Vezérműrögztítő szerszámkészlet  
RO Set blocare distributie auto  
F Outil de blocage d'arbre à cames  
I Set di bloccaggio distribuzione auto  
E Juego de bloques de distribución  
CN 正时皮带固定器组套



3  
PCS

FOR VALVETRAIN  
DO UKŁADU  
ROZRZĄDU

FOR DIESEL  
ENGINES  
DO SILNIKÓW  
DIEŚLA

FOR GASOLINE  
ENGINES  
DO SILNIKÓW  
BENZYNOWYCH

**APPLICATION:**

**RENAULT:** Twingo, Clio, Kangoo, Megane, Scenic, Laguna, Espace 1.2, 1.4, 1.6, 1.8, 2.0 16v (98-06), 1.5dCi;  
**NISSAN:** Micra1.5dCi, Kubistar 1.6 16v (03-06); **OPEL:** Vivaro 2.0 16v (01-06)

**ZASTOSOWANIE:**

**RENAULT:** Twingo, Clio, Kangoo, Megane, Scenic, Laguna, Espace 1.2, 1.4, 1.6, 1.8, 2.0 16v (98-06), 1.5dCi;  
**NISSAN:** Micra1.5dCi, Kubistar 1.6 16v (03-06); **OPEL:** Vivaro 2.0 16v (01-06)



BMC  
& COLOR  
SLEEVE

**ENGINE CODES:**

**RENAULT:** D4F, K4J, K4M, F4P F4R, F4Rt, F5R740, K9K;  
**NISSAN:** K9K, K4M; **OPEL:** FR4 720

**SILNIKI O KODZIE:**

**RENAULT:** D4F, K4J, K4M, F4P F4R, F4Rt, F5R740, K9K;  
**NISSAN:** K9K, K4M; **OPEL:** FR4 720

|             |    |
|-------------|----|
| <b>YATO</b> |    |
| YT-06014    | 10 |

GB Timing locking set  
D Arretierwerkzeugsatz für Nockenwellen  
PL Zestaw blokad rozrządu  
RUS Набор блокировок к колесам  
распределительных механизмов  
CZ Blokovací sada pro opravy rozvodů

H Vezérműrögztítő szerszámkészlet  
RO Set blocare distributie auto  
F Outil de blocage d'arbre à cames  
I Set di bloccaggio distribuzione auto  
E Juego de bloques de distribución  
CN 正时皮带固定器组套

|          |   |   |                        |
|----------|---|---|------------------------|
| 4<br>PCS | FOR VALVETRAIN<br>DO UKŁADU<br>ROZRZĄDU | FOR GASOLINE<br>ENGINES<br>DO SILNIKÓW<br>BENZYNOWYCH | DROP<br>FORGED<br>KUTE |
|----------|---|---|------------------------|

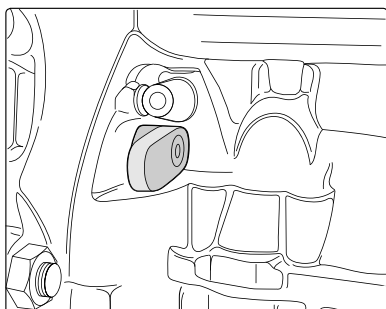
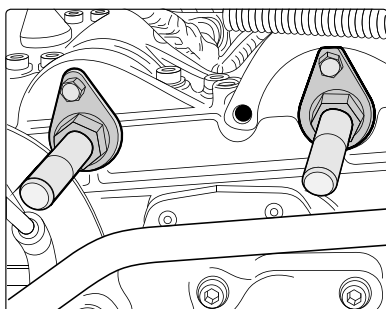

Timing locking set for engines 1.2 6V / 12V (chain)

Zestaw blokad rozrządu silników 1.2 6V / 12V (łańcuch)

**APPLICATION:**

**VW, SKODA, SEAT** 1.2 12V and 1.2 6V (HTP);  
**VW:** Polo;  
**SEAT:** Ibiza, Cordoba;  
**SKODA:** Fabia HTP;  
Engine codes AZQ, AWY, BMD, BME (02-07).

**ZASTOSOWANIE:**

**VW, SKODA, SEAT** 1.2 12V i 1.2 6V (HTP);  
**VW:** Polo;  
**SEAT:** Ibiza, Cordoba;  
**SKODA:** Fabia HTP;  
Silniki o kodzie AZQ, AWY, BMD, BME (02-07).

**SET INCLUDES:**

- camshaft locking pin 1 pc
- crankshaft locking pin 1 pc
- camshaft locking clamps 2 pcs

**ZESTAW ZAWIERA:**

- trzpień blokujący wałek rozrządu 1 szt.
- trzpień blokujący wał korbowy 1 szt.
- zacisk blokujący wałki rozrządu 2 szt.



BMC  
& COLOR  
SLEEVE

|             |    |
|-------------|----|
| <b>YATO</b> |    |
| YT-06012    | 20 |



- GB Timing locking set
- D Arretierwerkzeugsatz für Nockenwellen
- PL Zestaw blokad rozrządu
- RUS Набор блокировок к колесам распределительных механизмов
- CZ Blokovací sada pro opravy rozvodů
- H Vezérműrgőztítő szerszámkészlet
- RO Set blocare distributie auto
- F Outil de blocage d'arbre à cames
- I Set di bloccaggio distribuzione auto
- E Juego de bloques de distribución
- CN 正时皮带固定器组套

**APPLICATION:**

**FIAT:** 500, Panda, Grande Punto, Albea, Linea, Bravo, Brava, Palio, Idea, Weekend, Siena, Stilo, Marea (97-10); **LANCIA:** Ypsilon, Musa (96-10)

**ENGINE CODES:**

1.2 16V - 176B9.000, 182B2.000, 188A5.000, 1.4 16V - 843A1.000, 169A3.000, 192B2.000, 198A1.000, 198A4.000, 199A6.000

**ZASTOSOWANIE:**

**FIAT:** 500, Panda, Grande Punto, Albea, Linea, Bravo, Brava Palio, Idea, Weekend, Siena, Stilo, Marea (97-10); **LANCIA:** Ypsilon, Musa (96-10)

**SILNIKI O KODZIE:**

1.2 16V - 176B9.000, 182B2.000, 188A5.000, 1.4 16V - 843A1.000, 169A3.000, 192B2.000, 198A1.000, 198A4.000, 199A6.000



5  
PCS

FOR VALVE TRAIN  
DO UKŁADU  
ROZRZĄDU

FOR GASOLINE  
ENGINES  
DO SILNIKÓW  
BENZYNOWYCH

BMC  
& COLOR  
SLEEVE

|             |    |
|-------------|----|
| <b>YATO</b> |    |
| YT-06016    | 10 |

- GB Timing locking set
- D Arretierwerkzeugsatz für Nockenwellen
- PL Zestaw blokad rozrządu
- RUS Набор блокировок к колесам распределительных механизмов
- CZ Blokovací sada pro opravy rozvodů
- H Vezérműrgőztítő szerszámkészlet
- RO Set blocare distributie auto
- F Outil de blocage d'arbre à cames
- I Set di bloccaggio distribuzione auto
- E Juego de bloques de distribución
- CN 正时皮带固定器组套

**APPLICATION:**

**OPEL:** Astra, Vectra, Signum, Zafira, 1.9 CDTi (04 - 06);  
**FIAT:** 1.9, 2.4 JTD; 16v, 20v;

**ALFA ROMEO:** 147, 156, GT 1.9 JTD 16v, 2.4 JTD 20v

**ENGINE CODES:**

**OPEL:** Z19DTH, Z19DT;

**ALFA ROMEO:** 192 A5.000, 192 B1.000, 937 A4.000, 937 A5.000

**ZASTOSOWANIE:**

**OPEL:** Astra, Vectra, Signum, Zafira, 1.9 CDTi (04 - 06);

**FIAT:** 1.9, 2.4 JTD; 16v, 20v.; **ALFA ROMEO:** 147, 156, GT 1.9 JTD 16v, 2.4 JTD 20v

**SILNIKI O KODZIE:**

**OPEL:** Z19DTH, Z19DT; **ALFA ROMEO:** 192 A5.000, 192 B1.000, 937 A4.000, 937 A5.000



6  
PCS

FOR VALVE TRAIN  
DO UKŁADU  
ROZRZĄDU

FOR DIESEL  
ENGINES  
DO SILNIKÓW  
DIELSA

BMC  
& COLOR  
SLEEVE

|             |    |
|-------------|----|
| <b>YATO</b> |    |
| YT-06013    | 10 |

- GB Timing locking set
- D Arretierwerkzeugsatz für Nockenwellen
- PL Zestaw blokad rozrządu
- RUS Набор блокировок к колесам распределительных механизмов
- CZ Blokovací sada pro opravy rozvodů
- H Vezérműrgőztítő szerszámkészlet
- RO Set blocare distributie auto
- F Outil de blocage d'arbre à cames
- I Set di bloccaggio distribuzione auto
- E Juego de bloques de distribución
- CN 正时皮带固定器组套



8  
PCS

AI

BMC  
& COLOR  
SLEEVE

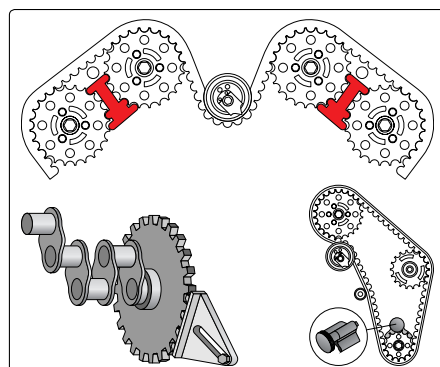

| <b>YATO</b> | No. | No.  |  |   |
|-------------|-----|--|--|---|
| YT-0633     |     | Vauxhall/Opel: ASTRA G 1.7 TD, ASTRA G 2.0 16V, VECTRA 1.8/2.0 16V > 1995  |  | Volkswagen: BORA 1.9TDI, GOLF 1.9TDI, LUPO 1.2/1.4/3.0 TDI, POLO 1.4TDI PASSAT 1.9TDI   |
|             |     | Vauxhall/Opel: ASTRA G 1.4/1.6/1.8 16V > 1994, VECTRA 1.6/1.8 16V, ZAFIRA 1.6/1.8 16V  |  | Citroen: BERLINGO 1.9D, DISPATCH 1.9D/TFD-FSO 1.9D, RELAY 1.9D/TD, SYNERGIE 1.9/2.0T, SANTIA 1.9/2.0 D/TD/HDI, XSARA 1.9/2.0 D/HDI, ZX 1.9D/TD, most diesels<br>Fiat: DUCATO 2.0D, ULYSSE 1.8/2.0 TURBO<br>Ford: most diesels<br>Peugeot: 205 1.6/1.8/1.9D, 305 1.6/1.8/1.9D, 306 1.8/1.9D/TD, 309 1.6/1.9D-4.5 1.6/1.9D, 406 1.9D, 605 2.0D/TD, 806 1.9TD,<br>Boxer 1.9/2.0 D/TD, EXPERT 1.9D, PARTNER 1.9D<br>Talbot: EXPRESS D, HORIZON D-J5 D, SOLARA D |
|             |     | right hand camshaft<br>Saab: 900-9000<br>Vauxhall/Opel: CALIBRA 2.5/2.5/2.6 V6, CAVALIER 2.5i V6, OMEGA B 2.5/2.6/3.0/3.2 V6, SINTRA 3.0 V6, VECTRA A 2.5/2.6 V6 |  |   |
|             |     | left hand camshaft<br>Saab: 900-9000<br>Vauxhall/Opel: CALIBRA 2.5/2.5/2.6 V6, CAVALIER 2.5i V6, OMEGA B 2.5/2.6/3.0/3.2 V6, SINTRA 3.0 V6, VECTRA A 2.5/2.6 V6  |  | Isuzu: 1.5/1.7 diesel engines<br>Vauxhall/Opel: 1.6/1.7 diesel engines, 1.2/1.4/1.6/1.8/2.0 OHC petrol engines  |
|             |     | Rover: 25 1.4/1.6/1.8/VVC, 45 1.4/1.6/1.8, 75 1.8, 200 VI, 214 16V, 216 16V/CABRIO/COUPE, 218 COUPE, 414 16V, 416 16V, BRM 1.8VVC                                |  |   |



- GB Timing locking set for V.A.G.  
D Einstellwerkzeug Zahnriemen nockenwellen  
Arretierwerkzeug steuerriemen für V.A.G.  
PL Zestaw blokad rozrządu dla V.A.G.  
RUS Набор блокировок газораспределения для V.A.G.  
CZ Sada aretacie rozvodov pro V.A.G.  
H Vezérműrögítő szerszámkészlet merít V.A.G.  
RO Set blocare distributie auto pt. V.A.G.  
F Outil de blocage d'arbre à cames  
I Set di bloccaggio distribuzione auto  
E Juego de bloques de distribución para V.A.G.  
CN 大众&奥迪正时工具

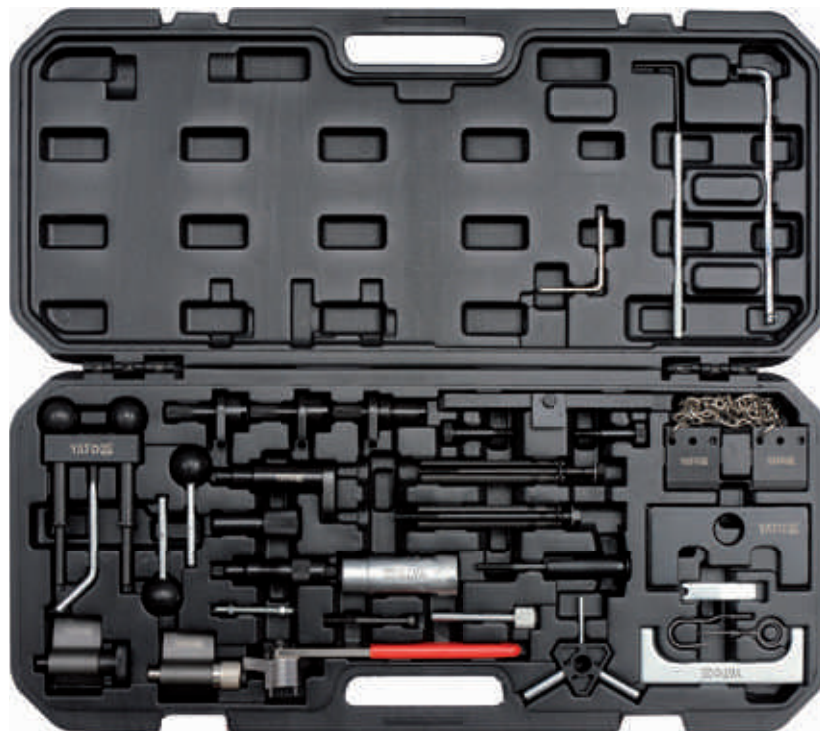

34  
PCS

FOR / DLA  
V.A.G.

BMC  
& COLOR  
SLEEVE



|             |   |
|-------------|---|
| <b>YATO</b> |   |
| YT-06015    | 4 |

- GB Diesel injector puller  
D Stoßabziehvorrichtung für Einspritzdüse  
PL Ściągacz bezwładnościowy do wtryskiwaczy  
RUS Ударный съемник форсунок  
CZ Rázový vytahovač vstřikovačů  
H Diesel porlasztó kieszdő  
RO Dispozitiv de scoas injectoare  
F Extracteur à choc d'injecteurs  
I Martello scorrevole per la rimozione degli iniettori  
E Tuerca tensora de impacto para inyectores  
CN 柴油喷油嘴拔取器



**BOSCH TYPE** **LUCAS TYPE** **M8 M12 M14**

BMC  
& COLOR  
SLEEVE

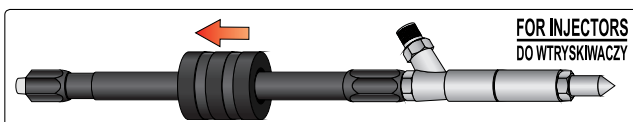

|             |    |
|-------------|----|
| <b>YATO</b> |    |
| YT-0617     | 20 |

- GB Overhead valve spring compressor  
D Vorrichtung zur Demontage von Motorventilen  
PL Przyrząd do demontażu zaworów silnikowych  
RUS Устройство для демонтажа клапанов двигателя  
CZ Přípravek na demontáž ventilů motoru  
H Szeleplehúzó készülék  
RO Dispozitiv pt. demontarea supapelor la motoare  
F Outil pour démonter les soupapes de moteur  
I Strumento per la rimozione di valvole motore  
E Instrumento para desmontaje de válvulas de motor  
CN 下压式凡尔钳



SLIDING  
CARD



16

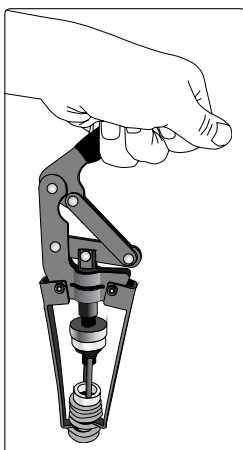

|             |      |
|-------------|------|
| <b>YATO</b> |      |
| YT-0618     | 5/25 |

- GB Lambda sensor thread chaser  
 D Lambdasonde gewinde reparatur-set  
 PL Zestaw do naprawy gwintów sondy lambda  
 RUS Набор для ремонта сорванной резьбы винтов  
 CZ Sada na opravu závitu Lambda sondy  
 H Menejavitó készlet Lambda szondához  
 RO Dispozitiv pt. curatat filet sonda lambda  
 F Set de réparation filetage de sonde lambda  
 I Chiavi a bussola per sonda lambda  
 E Cazador del hilo de rosca para sonda lambda  
 CN 火星塞丝攻组套

FOR OXYGEN SENSOR DO SONDY LAMBDA  
**HRC 50**  
**M12 x 1.25**  
**M18 x 1.5**



SLIDING CARD

|             |       |
|-------------|-------|
| <b>YATO</b> |       |
| YT-1756     | 12/96 |

- GB Oxygen sensor crowfoot wrench  
 D Schlüssel für die Lambdasonde  
 PL Klucz do sondy lambda  
 RUS Ключ для зонда lambda  
 CZ Klíč na sondu lambda
- H Lambda szonda kulcs  
 RO Cheie pt. sonda lambda  
 F Clé pour sonde lambda  
 I Chiave per sonda lambda  
 E Llave para la sonda lambda  
 CN 氧传感器套筒扳手

SLIDING CARD



**22 mm**  
 FOR OXYGEN SENSOR DO SONDY LAMBDA



**CrMo SCM-440**

|             |       |
|-------------|-------|
| <b>YATO</b> |       |
| YT-1753     | 30/60 |



**CrV 50BV30**

|             |      |
|-------------|------|
| <b>YATO</b> |      |
| YT-1754     | 6/36 |

- GB Socket and oxygen sensor set  
 D Steckschlüssel für die Lambda-Sonde  
 PL Klucze nasadowe do sondy lambda  
 RUS Торцевые ключи с внутренним многогранником для зонда lambda  
 CZ Nástrčné kľíče na sondy lambda  
 H Dugókulcs lambda szondához  
 RO Prize pt. sonda lambda  
 F Douille pour sonde lambda  
 I Set di riparazione per filetti di sonda lambda  
 E Llaves de cubo para la sonda lambda  
 CN 氧传感器套筒扳手套组

- 22 mm; L=50 mm; 6PT; CrMo SCM440;  
 22 mm; L=30 mm; 6PT; CrMo SCM440;  
 22 mm; L=80 mm; 6PT; CrV 50BV30



BMC & COLOR SLEEVE



|             |    |
|-------------|----|
| <b>YATO</b> |    |
| YT-1752     | 20 |

- GB Oxygen sensor and fuel injectors wrench set  
 D Steckschlüsselsatz für die Lambdasonde und die Einspritzdüsen  
 PL Zestaw nasadek do sondy lambda i wtryskiwaczy  
 RUS Набор насадок к лямбда-зондам и форсункам  
 CZ Sada nástavců na demontáž sondy lambda a vstříkovačů  
 H Dugókészlet lambda szondákhoz és injektorokhoz  
 RO Set inelare pt. sonda lambda și injectoare  
 F Douilles pour sonde lambda et injecteurs  
 I Set di riparazione per filetti di sonda lambda  
 E Juego de boquillas para la sonda lambda y para inyectores  
 CN 氧传感器套筒扳手套组

- 1/2" (12.7 mm) x 29 mm; L=90 mm; 6PT;  
 3/8" (9.5 mm) x 22 mm; L=90 mm; 6PT;  
 1/2" (12.7 mm) x 27 mm; L=78 mm; 12PT;  
 3/8" (9.5 mm) x 27 mm; L=74 mm; 6PT;  
 3/8" (9.5 mm) x 22 mm; L=80 mm; 6PT;  
 1/2" (12.7 mm) x 22 mm; L=50 mm; 6PT;  
 3/8" (9.5 mm) x 22 mm; L=30 mm; 6PT



FOR FUEL INJECTORS DO WTRYSKÓW PALIWA



BMC & COLOR SLEEVE

|             |                                 |   |
|-------------|---------------------------------|---|
| <b>YATO</b> | size / rozmiar                  |   |
| YT-1751     | 1/2" (12.7 mm)<br>3/8" (9.5 mm) | 5 |



- GB** Diesel injection socket set  
**D** Aufsätze für die Einspritzungen bei Dieselmotoren  
**PL** Zestaw nasadek do wtrysków w silnikach Diesla  
**RUS** Набор насадок к форсункам в дизельных двигателях  
**CZ** Sada nástavců na trysky dieselových motorů  
**H** Szerszámkészlet Dieselmotor befecskendezőkhöz  
**RO** Set de capete pt. injectoare în motoare Diesel  
**F** Set des douilles pour injecteurs (diesel)  
**I** Set di custodie per i motori diesel  
**E** Juego de tapones para las inyecciones en los motores de Diesel  
**CN** 柴油机油嘴套筒组套





|  |                       |          |     |
|--|-----------------------|----------|-----|
| <b>6</b><br>PCS                          | <b>1/2"</b><br>12.5mm | AS-DRIVE | CrV |
| FOR FUEL INJECTORS<br>DO WTRYSKÓW PALIWA |                       |          |     |



BMC & COLOR SLEEVE

21x90; 22x78; 22x110; 27x78; 28x78; 28x83 mm

| YATO  | size / rozmiar |  |
|--|----------------|---|
| YT-0622  | 1/2" (12.7 mm) | 10  |

- GB** Diesel injector and cutter set  
**D** Fräsersatz für die Buchsen der Einspritzdüsen  
**PL** Zestaw frezów do gniazd wtryskiwaczy common rail  
**RUS** Комплект фрез для гнезд сопел форсунки  
**CZ** Sada fréz na sedla trysek vstříkovačů  
**H** Marókészlet befecskendező fúvókájának fészkehez  
**RO** Set de freze pt. socluri de duze injectoare  
**F** Alimentation d'un injecteur de common rail  
**I** Set frese per sedi iniettori common rail  
**E** Juego de fresas para el asiento de toberas de inyectoros  
**CN** 7件套气门较刀



|                 |                |
|-----------------|----------------|
| <b>7</b><br>PCS | CrMoV<br>SKD11 |
|-----------------|----------------|

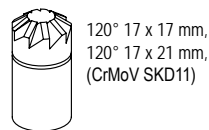
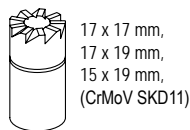
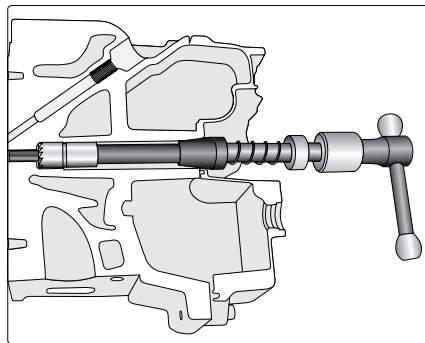

BMC & COLOR SLEEVE



| YATO  |  |
|--|---|
| YT-17625   | 10  |









- GB** Tooth socket for injection nozzle  
**D** Stiftschlüsselsatz für die Einspritzdüse in Lastkraftwagen  
**PL** Zestaw kluczy czopowych do wtryskiwaczy w samochodach ciężarowych  
**RUS** Набор шиповых ключей к форсункам грузовых автомобилей  
**CZ** Sada klíčů na vstříkovače pro nákladní automobily  
**H** Csaposkulcs készlet tehergépkocsi befecskendezőjéhez  
**RO** Set chei tubulare cu ungere pt. camioane  
**F** Set de douilles injecteurs  
**I** Set di chiavi per iniettori camion  
**E** Juego de llaves de muñón para los inyectoros en camiones  
**CN** 卡车喷油嘴套筒组套





|  |                       |     |
|--|-----------------------|-----|
| <b>4</b><br>PCS                          | <b>1/2"</b><br>12.5mm | HEX |
| CrMo                                     | S45C                  | CrV |
| FOR FUEL INJECTORS<br>DO WTRYSKÓW PALIWA |                       |     |

BMC & COLOR SLEEVE



-   1/2" (12.7 mm); L=72 mm; 4T; CrV;  
  32 mm; M14 x 1.5 mm; L=70 mm, 4T; S45C;  
  1/2" (12.7 mm); L=120 mm; 3T; CrMo;  
  32 mm; L=120 mm, 4T; S45C

| YATO  | size / rozmiar |  |
|--|----------------|---|
| YT-1762  | 1/2" (12.7 mm) | 16  |



- GB Fuel injection test kit
- D Diagnosesatz für die Prüfung der Kraftstoffeinspritzung
- PL Zestaw diagnostyczny do wtrysku paliwa
- RUS Пневматический набор к тормозным зажимам
- CZ Souprava k diagnostice vstřikování paliva
- H Diagnosztikai készlet üzemanyag - befecskendőzökhöz
- RO Ansamblu pt. diagnosticarea injectiei combustibilului
- F Kit de test de débit d'injecteur
- I Set diagnostico per iniettori la benzina
- E Juego de herramientas diagnosticas para la inyección de combustible
- CN 燃料注射测试组套

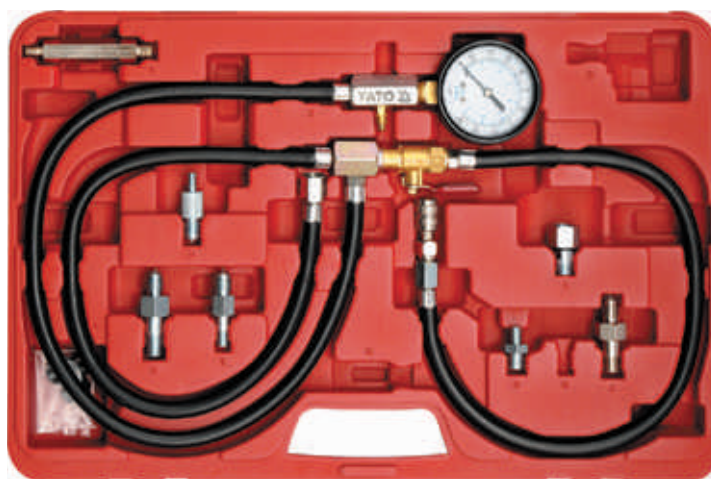

10  
PCS

P max.  
0.7 MPa

BMC  
& COLOR  
SLEEVE



|             |    |
|-------------|----|
| <b>YATO</b> |    |
| YT-0670     | 10 |

- GB Compression pressure gauge in a diesel engine
- D Kompressionsdruckmesser in Dieselmotoren
- PL Miernik ciśnienia sprężania w silnikach diesla
- RUS Измеритель давления компрессии в дизельных двигателях
- CZ Souprava k měření kompresních tlaků v dieselových motorech
- H Dieselmotorok kompresszióját mérő óra
- RO Manometrul presiunii aerului comprimat pt. motoarele diesel
- F Testeur de pression cylindrique diesel
- I Tester prova compressione motori diesel
- E Medidor de presión de la compresión en los motores diesel
- CN 柴油机压力测试组套



16  
PCS

70 bar  
max.

FOR DIESEL  
ENGINE  
DO SILNIKOW  
DIESLA

BMC  
& COLOR  
SLEEVE



- 70 bar, 500 mm;
- 160 mm;
- M20x1.5: 75 mm; M22x1.5: 73 mm; M24x1.5: 88 mm; M24x2: 63 mm;
- M10x1: 83, 91, 102, 113, 119 mm; M10x1.25: 64, 135 mm; M12x1.25: 47 mm; M22x1.5: 118 mm;

|             |   |
|-------------|---|
| <b>YATO</b> |   |
| YT-7307     | 5 |

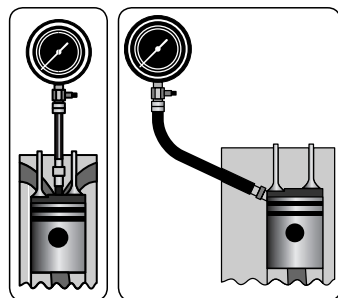

16

- GB Oil pressure tester
- D Öldruckanzeige
- PL Miernik ciśnienia oleju
- RUS Тестер давления масла с адаптерами
- CZ Tester tlaku oleje
- H Olajnyomásmérő készlet
- RO Tester presiune ulei
- F Set de testeurs de pression d'huile
- I Tester misurazione pressione dell'olio
- E Manómetro de aceite
- CN 自动波箱压力表



12  
PCS

185 cm  
HOSE  
WAZ

FOR ALL TYPES  
OF ENGINES  
DO WSZYCH TYPOW  
SILNIKOW

0-35 bar

0-500 PSI

BMC  
& COLOR  
SLEEVE



|             |    |
|-------------|----|
| <b>YATO</b> |    |
| YT-73030    | 10 |

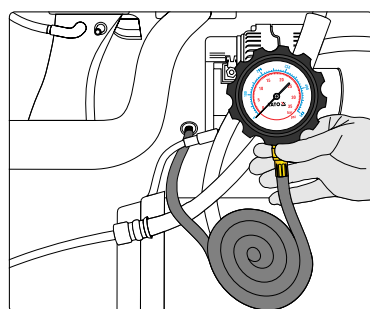



- GB Compression tester  
D Druckluftmessgerät  
PL Miernik ciśnienia sprężania  
RUS Тестер компрессии
- CZ Měřicí přístroj kompresního tlaku  
H Kompresszió mérő  
RO Aparat de măsurarea presiunii  
F Testeur de pression adaptateur cône
- I Monometro pressione  
E Medidor de compresión  
CN 气缸压力表

**FOR ALL TYPES**  
DO WSZYSTKICH TYPOW



**21 bar max.**

FOR SPARK IGNITION  
DO ZAPALNOI SKROWEGO

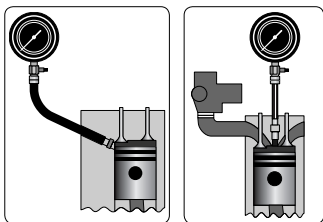

BMC & COLOR SLEEVE

RUBBER ADAPTOR ZŁĄCZE GUMOWE

COLOR BOX



THREADED ADAPTOR ZŁĄCZE GWINTOWANE

COLOR BOX



THREADED ADAPTOR ZŁĄCZE GWINTOWANE

RUBBER ADAPTOR ZŁĄCZE GUMOWE



|             |       |
|-------------|-------|
| <b>YATO</b> |       |
| YT-7300     | 24/48 |

|             |       |
|-------------|-------|
| <b>YATO</b> |       |
| YT-7301     | 12/24 |

|             |      |
|-------------|------|
| <b>YATO</b> |      |
| YT-7302     | 6/24 |

- GB Flow meter common rail adapter set  
D Überlauf-Diagnosesatz für die Einspritzdüse Common rail  
PL Przelewowy zestaw diagnostyczny do wtryskiwaczy common rail  
RUS Диагностический набор к форсункам common rail; переливной  
CZ Souprava na diagnostiku vstřikovačů common rail, průtoková  
H Diagnosztikai készlet common rail injektorokhoz, átfolyós  
RO Set diagnostic preaplin pt. injectoare common rail  
F Kit de test de débit d'injecteur common rail  
I Set controllo portata iniettori common rail  
E Juego diagnóstico de flujo para inyectores common rail  
CN 柴油燃油喷嘴检测工具

**31 PCS**

FOR 6 CYLINDERS DO 6 CYLINDRÓW

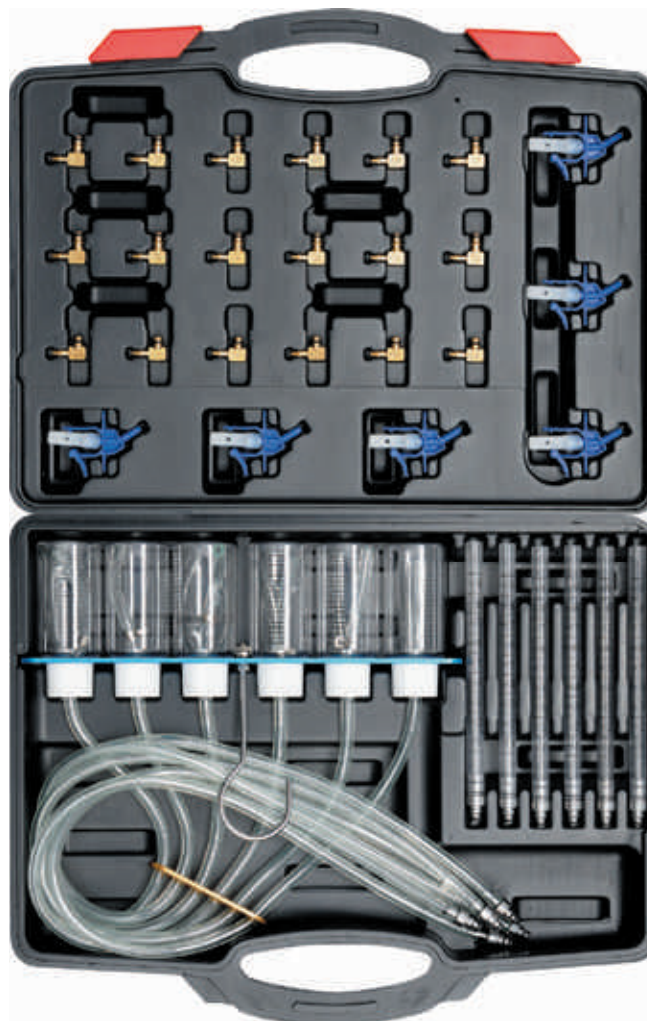

BMC & COLOR SLEEVE

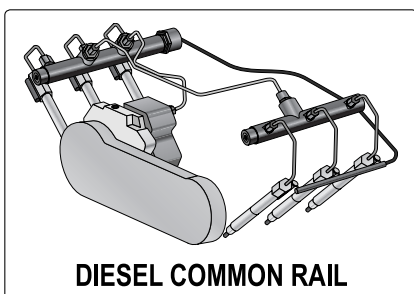

**DIESEL COMMON RAIL**

|             |   |
|-------------|---|
| <b>YATO</b> |   |
| YT-7306     | 5 |



GB Combined sockets for alternator  
 D Werkzeugsatz für Lichtmaschine  
 PL Zestaw do alternatorów ze sprzęgłem  
 RUS Набор для альтернатора  
 CZ Souprava na opravu alternátorů  
 H Generátor szerszámkészlet  
 RO Garnitură pt. alternator

F Set de clés à l'alternateur avec l'embrayage  
 I Set di chiavi per smontaggio puleggia e alternatore  
 E Enchufes combinados para alternador  
 CN 发动机拆卸组套

13 PCS 1/2" 12.5mm

HEX TORX SPLINE CrV

HRC 40-44 S45C HRC 38-42 STEEL 8660

HRC 53-57

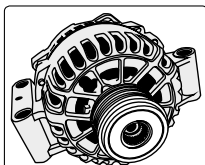

**FOR ALTERNATORS  
 DO ALTERNATORÓW**

- 1/2" (12.7 mm): M10, HBS, 33T, L=110 mm; CrV; HRC 40-44;
- 1/2" (12.7 mm): T50, HBS, 33T, L=110 mm; CrV; HRC 40-44;
- M8, M10, L=75 mm; 8660; HRC 53-57;
- T40, T50, L=75 mm; 8660; HRC 53-57;
- H8, H10, L=75 mm; 8660; HRC 53-57;

- H15, 33T, L=30 mm; CrV; HRC 40-44;
- H22, 33T, L=30 mm; CrV; HRC 40-44;
- H22, L=30 mm; S45C; HRC 38-42;
- Ø 35 x 30 mm; CrV; HRC 40-44;
- 1/2" (12.7 mm) x 10 mm; CrV; HRC 40-44



BMC & COLOR SLEEVE

|             |                |    |
|-------------|----------------|----|
| <b>YATO</b> | ○              |    |
| YT-0421     | 1/2" (12.7 mm) | 15 |

GB Combined sockets for alternator  
 D Werkzeugsatz für Lichtmaschine  
 PL Zestaw do alternatorów ze sprzęgłem  
 RUS Набор для альтернатора  
 CZ Souprava na opravu alternátorů  
 H Generátor szerszámkészlet  
 RO Garnitură pt. alternator

F Set de clés à l'alternateur avec l'embrayage  
 I Set di chiavi per smontaggio puleggia e alternatore  
 E Enchufes combinados para alternador  
 CN 发动机拆卸组套

22 PCS 1/2" 12.5mm

HEX TORX SPLINE CrV

HRC 40-44 S45C

HRC 38-42 STEEL 8660 HRC 53-57

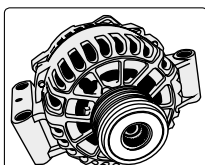

**FOR ALTERNATORS  
 DO ALTERNATORÓW**

- 1/2" (12.7 mm): M10, HBS, 33T, L=113 mm; CrV; HRC 40-44 / 8660; HRC 53-57;
- 1/2" (12.7 mm): T50, HBS, 33T, L=113 mm; CrV; HRC 40-44 / 8660; HRC 53-57;
- 3/8" (10 mm): M10, HBS, 33T, L=80 mm; CrV; HRC 40-44 / 8660; HRC 53-57;
- 1/2" (12.5 mm): M10; HBS, 33T, L=140 mm; CrV; HRC 40-44;
- M8, M10, L=75 mm; 8660; HRC 53-57;
- T40, T50, L=75 mm; 8660; HRC 53-57;

- H8, H10, L=75 mm; 8660; HRC 53-57;
- M8xH12, L=64 mm; 8660; HRC 53-57;
- H15, 33T, Ø 17 mm, L=30 mm, H15, 33T, Ø 19 mm, L=30 mm, H22, 33T, Ø 19 mm, L=30 mm; CrV; HRC 40-44;
- H17, H22, L=30 mm; S45C; HRC 38-42;
- Ø 35 x 30 mm; S45C; HRC 38-42;
- Ø 38 mm; S45C; HRC 38-42;
- H19x28, H21x28, H22x28; S45C; HRC 38-42;
- 1/2" (12.5 mm) (F) x 10 mm (F); CrV; HRC 40-44



BMC & COLOR SLEEVE

|             |                |               |   |
|-------------|----------------|---------------|---|
| <b>YATO</b> | ○              | ○             |   |
| YT-04211    | 1/2" (12.7 mm) | 3/8" (9.5 mm) | 5 |



- GB Stroboscopic tube
- D Stroboskoplampe
- PL Lampa stroboskopowa
- RUS Стробоскопная лампа
- CZ Stroboskopická lampa
- H Stroboszkóp lámpa
- RO Lampă stroboscopică
- F Lampe stroboscopique
- I Lampada stroboscopica
- E Tubo estroboscópico
- CN 点火正时灯

12 V

ENGINE SPEED  
max. 8000 min<sup>-1</sup>  
max.

XENON

DOUBLE  
BLISTER

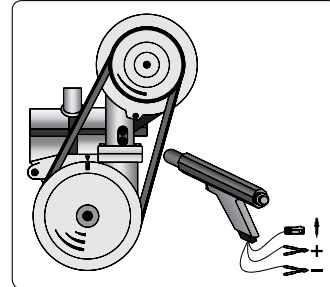

0-60°

**YATO**

YT-7310



6/12

**YATO**

YT-7311



6/12

**YATO**

YT-7312



6/12

- GB Universal radiator pressure kit
- D Diagnosekit für Kühler
- PL Zestaw diagnostyczny do chłodnicy
- RUS Диагностический набор к радиатору
- CZ Souprava k diagnostice chladiče
- H Diagnosztikai készlet hűtőkhöz

- RO Ansamblu pt. diagnosticarea radiatorului
- F Set diagnostique pour radiateur de voiture
- I Set universale tester pressione del radiatore para el radiador
- E Juego de herramientas diagnosticas para el radiador
- CN 万用水箱压力测试组套

14  
PCS

P max.  
0.25 MPa

200°C  
max.

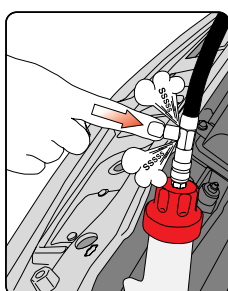
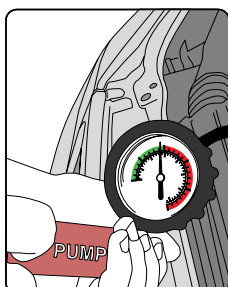
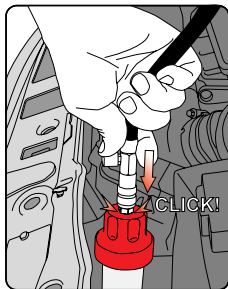

| <b>YATO</b> | No. |  |   |
|-------------|-----|--|---|
| YT-0672     | 2   |  | General Motors  |
|             | 3   |  | Mercedes, General Motors, Jeep  |
|             | 4   |  | Peugeot, Subaru, Chrysler, Acura, General Motors, Mitsubishi, Nissan, Mazda, Toyota, Infiniti, GEO, Suzuki, Isuzu, Ford |
|             | 5   |  | Honda, Toyota, Suzuki, Mitsubishi, Chrysler, Acura  |
|             | 6   |  | Audi, BMW, Volkswagen, Porsche  |
|             | 7   |  | Volvo, Saab, Citroen, Renault, Fiat, Alfa Romeo, Jeep   |
|             | 8   |  | Volkswagen  |
|             | 9   |  | Mercedes, General Motors, Jeep  |
|             | 10  |  | BMW   |
|             | 11  |  | Audi, Volkswagen  |
|             | 12  |  | Ford, Land Rover, Opel, Jaguar, Mercedes  |
|             | 13  |  | Mercedes  |



- GB Hand-held vacuum pump
- D Unterdruckpumpe mit Zubehör
- PL Pompka podciśnieniowa z akcesoriami
- RUS Насос вакуумметрического давления с принадлежностями
- CZ Podtlaková pumpa s příslušenstvím
- H Vákuum- és ac-pumpa mérő, tartozékokkal
- RO Pompa de vidare cu accesorii
- F Pompe à vide avec les accessoires
- I Pompa a pressione con accessori
- E Bomba de subpresión con accesorios
- CN 手持式真空泵



**16**  
PCS **-1÷0**  
bar

BMC  
& COLOR  
SLEEVE



**YATO**  
YT-0673 10

- GB Hand-held vacuum pump
- D Unterdruck-druckpumpe mit Zubehör
- PL Pompka ciśnieniowo-podciśnieniowa z akcesoriami
- RUS Насос вакуумметрического давления с принадлежностями
- CZ Podtlaková-tlaková pumpa s příslušenstvím
- H Vákuum- és ac-pumpa mérő, tartozékokkal
- RO Pompa de vidare cu accesorii
- F Pompe à vide avec les accessoires
- I Pompa a pressione con accessori
- E Bomba de subpresión-presión con accesorios
- CN 手持式真空泵



**22**  
PCS **-1÷3**  
bar

BMC  
& COLOR  
SLEEVE



**YATO**  
YT-0674 5

16

- GB Flexible line clamp
- D Schlauchklemmensatz
- PL Komplet zacisków do przewodów z cieczą
- RUS Набор зажимов с фиксатором
- CZ Sada hadicových svěrek
- H Flexibilis cső elszorító készlet
- RO Clema flexibila
- F Set de pices pour serrer les
- I Set pinze per chiudere momentaneamente i manicotti
- E Juego de alicates apretadores para conductos de líquidos
- CN 油管封口钳组套

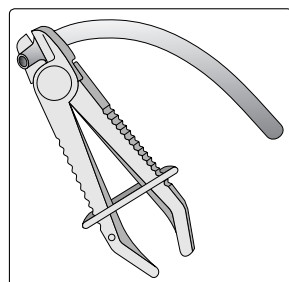

1/4" - 3/4"



1/2" - 5/4"



3/4" - 9/4"



1/4" - 3/4" for brake and fuel lines  
6.3 - 19.0 mm do przewodów hamulcowych i paliwowych

1/2" - 5/4" for flexible hose  
12.5 - 32.0 mm do przewodów elastycznych

3/4" - 9/4" for radiator hose clamp  
19.0 - 57.0 mm do przewodu chłodnicy

**3**  
PCS

WILL NOT  
CUT HOSES  
NIE NISZCZY  
PRZEWODÓW

NON-CONDUCTIVE  
NIEPRZEWODZĄCE



SLIDING  
CARD

**YATO**  
YT-0840 25/50



- GB Spark plug socket  
D Steckschlüssel mit Gummihalterung  
PL Nasadka do świec  
RUS Головка свечная  
CZ Nastavec pro svíčky  
H Gyújtógyertya toldalék  
RO Cheie de bujii  
F Douille à bougies  
I Chiavi a bussola  
E Boquilla de bujías  
CN 六角火花塞套筒

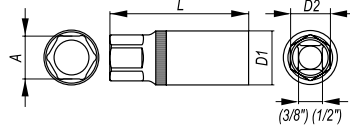

| YATO    | Ø              | A    | D1 (mm) | D2 (mm) | L (mm) | PCS packing: |        |
|---------|----------------|------|---------|---------|--------|--------------|--------|
| YT-3851 | 3/8" (9.5 mm)  | 16.0 | 22.0    | 19.0    | 64.0   | 10           | 50/100 |
| YT-1253 | 1/2" (12.7 mm) | 16.0 | 22.0    | 19.0    | 64.0   | 10           | 50/100 |
| YT-1254 | 1/2" (12.7 mm) | 21.0 | 27.8    | 24.0    | 64.0   | 10           | 50/100 |

- GB Spark plug socket  
D Kerzenschlüssel mit Verlängerungshebel  
PL Kluczek do świec z przedłużką  
RUS Ключ к свечам с удлинителем

- CZ Klič na svíčky s prodlužovacím nástavcem  
H Gyertyakulcs hosszabbítóval  
RO Cheie cu prelungitor, pt. bujii  
F Douille à bougies

- I Chiavi per candele a tubo  
E Llave para las bujías con extensión  
CN 火花塞套筒

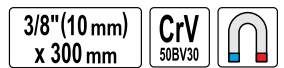

| YATO    | Ø (mm) |       |
|---------|--------|-------|
| YT-0817 | 16     | 10/40 |
| YT-0818 | 18     | 10/40 |
| YT-0819 | 21     | 10/40 |

- GB Bi-hexagonal spark plug socket  
D Zwölfkant-Kerzenschlüssel mit Verlängerungshebel  
PL Kluczek do świec dwunastokątny z przedłużką  
RUS Ключ к свечам с удлинителем

- CZ Klič dvanáctihranný na svíčky s prodlužovacím nástavcem  
H Gyertyakulcs hosszabbítóval, 12 lapú  
RO Cheie cu prelungitor, bihexagonală, pt. bujii

- F Douille à bougies  
I Chiavi per candele a tubo  
E Llave bihexagonal para las bujías con extensión  
CN 十二角火花塞套筒

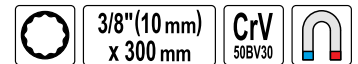

| YATO    | Ø (mm) |       |
|---------|--------|-------|
| YT-0812 | 14     | 10/40 |

- GB Joined glow plug socket set  
D Schlüsselsatz für Glühkerzen  
PL Zestaw kluczy do świec żarowych  
RUS Набор ключей к калильным свечам  
CZ Sada kličů na žhavicí svíčky  
H Gyertyakulcs készlet  
RO Set chei pt. bujii incandescente  
F Set de douilles à bougies  
I Set chiavi a bussola snodate per candele  
E Juego de llaves para bujías incandescentes  
CN 预热火花塞套筒组套

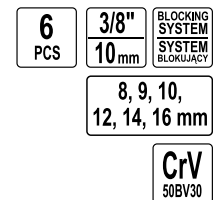

| YATO    | Ø             |    |
|---------|---------------|----|
| YT-0534 | 3/8" (9.5 mm) | 10 |



FOR GLOW PLUGS  
DO ŚWIEC ŻAROWYCH



- GB Torque angle gauge  
D Winkelmesser zum Anziehen von Schrauben  
PL Kątomierz do dokręcania śrub  
RUS Угломер для подвёртывания болтов  
CZ Úhloňer k utahování šroubů  
H Nyomaték szögmerő  
RO Raportor pt. inşurubat şuruburi  
F Rapporteur à serrer les vis  
I Goniometro per il serraggio controllo  
E Calibrador para apretar tornillos  
CN 扭力角度规



| YATO    |  |       |
|---------|--|-------|
| YT-0593 |  | 12/48 |

GB Metal conduit bender  
 D Biegevorrichtung für Metallleitungen  
 PL Giętarka do przewodów metalowych  
 RUS Гибочный станок для проводов из металла  
 CZ Ohýbačka kovových trubek  
 H Hajlító fémvezetékekhez

RO Maşina de indoit (curbat) pt. cabluri metalice  
 F Cintreuse au câble de frein  
 I Piegatrice per fili metalici  
 E Dobladora de tubos de metal  
 CN 弯管器

SLIDING CARD



AI



125 mm max. ∅ 6 mm



235 mm max. ∅ 12 mm



|             |        |       |
|-------------|--------|-------|
| <b>YATO</b> | L (mm) |       |
| YT-0813     | 125    | 24/96 |

|             |        |      |
|-------------|--------|------|
| <b>YATO</b> | L (mm) |      |
| YT-0814     | 235    | 6/48 |

GB Universal clutch adjustment set  
 D Universal-set, um die Kupplungsscheibe einstellen  
 PL Zestaw do centrowania tarczy sprzęgłowej  
 RUS Комплект для центровки дисков сцепления  
 CZ Univerzální sada pro nastavení spojky disk  
 H Kuplung központosító készlet  
 RO Trusa pt. centrare ambreiaje  
 F Centreur d'embrayage  
 I Set di centraggio frizione  
 E Herramienta alineación embrague  
 CN 燭磁動請每溟



9 PCS

∅ mm 11-25



BMC & COLOR SLEEVE

∅ 11, 15, 16.5, 17, 19, 20, 20.5, 25 mm

|             |  |    |
|-------------|--|----|
| <b>YATO</b> |  |    |
| YT-06311    |  | 20 |

GB Disc brake pad puller  
 D Träge Abziehvorrichtung für die Bremsklötze  
 PL Ściągacz bezwładnościowy do klocków hamulcowych  
 RUS Инерционный съёмник тормозных колодок  
 CZ Pomůcka k vytahování brzdových deštiček

H Fékbetét kisedő  
 RO Extractor de inerție pt. plăcuțele de frână  
 F Extracteur pour plaquettes de frein a inertie  
 I Estrattore per dischi freno  
 E Desmontador de inercia para las zapatas de freno  
 CN 刹车盘扳手

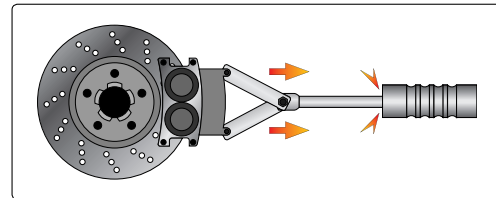

DROP FORGED KUTE

820g

28-128 mm



COLOR BOX

|             |  |    |
|-------------|--|----|
| <b>YATO</b> |  |    |
| YT-2538     |  | 20 |

GB Brake retainer spring tool  
 D Montagewerkzeug für Bremsfeder  
 PL Ściągacz sprężynek szcęk hamulcowych  
 RUS Съёмник для тормозных пружин  
 CZ Stahovač pružin brzdových čelistí  
 H Fékrugó szerelő szerszám  
 RO Dispozitiv pt. montat arc pe sabot

F Extracteur de ressorts freins  
 I Freno scarpa di fissaggio a molla compressori  
 E Herramienta para resorte retenedor de frenos  
 CN 刹车弹簧华司拆装器

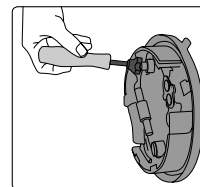

SLIDING CARD



FOR DRUM BRAKES DO HAMULCOW BĘBNOWYCH



|             |  |       |
|-------------|--|-------|
| <b>YATO</b> |  |       |
| YT-0685     |  | 12/96 |

|             |  |       |
|-------------|--|-------|
| <b>YATO</b> |  |       |
| YT-0686     |  | 12/72 |

GB Brake spring pliers kit  
 D Bremsbacken-montage set  
 PL Zestaw do montażu szcęk hamulcowych  
 RUS Набор инструментов для тормозных пружин  
 CZ Sada na montáž brzdových čelistí  
 H Fogókészlet fékrugóhoz

RO Dispozitiv pt. inlocuit garnituri cilindrii receptori  
 F Set pour le montage des mâchoires de freins  
 I Set per montaggio molle freni  
 E Juego para resortes de frenos  
 CN 刹车拆卸工具组套

3 PCS

FOR DRUM BRAKES DO HAMULCOW BĘBNOWYCH

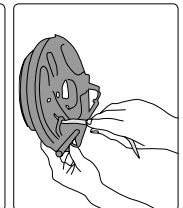
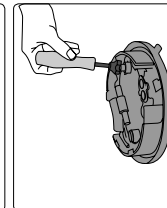
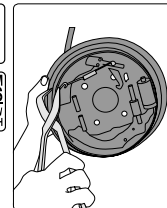

DOUBLE BLISTER



|             |  |      |
|-------------|--|------|
| <b>YATO</b> |  |      |
| YT-0684     |  | 6/24 |



- GB Professional brake tool set  
D Werkzeugsatz zum Wechseln der Bremsbacken  
PL Zestaw do wymiany szcęk hamulcowych  
RUS Набор для замены тормозных колодок  
CZ Sada na výměnu brzdových čelistí  
H Fékpofa-cserélő készlet  
RO Kit pt. înlocuirea sabotilor de frâna  
F Set pour mâchoires de freins  
I Set di regolazione del freno  
E Juego para el reemplazo de zapatas de freno  
CN 刹车拆卸工具组套

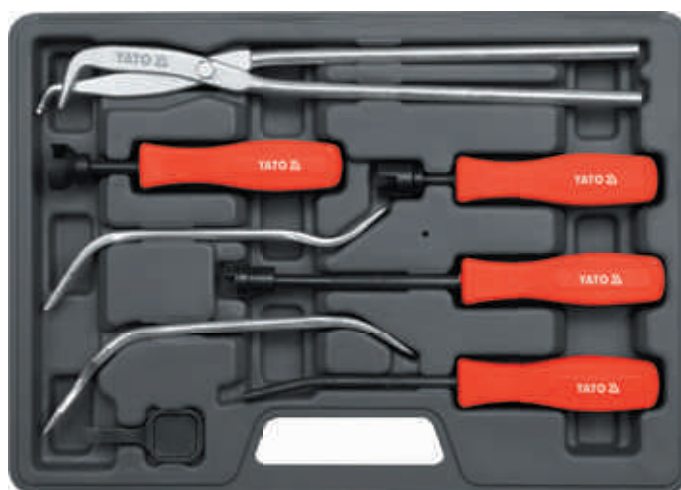

8  
PCS

FOR DRUM  
BRAKES  
DO HAMULCOWY  
BĘBNOWYCH

BMC  
& COLOR  
SLEEVE



**YATO**  
YT-0680

5

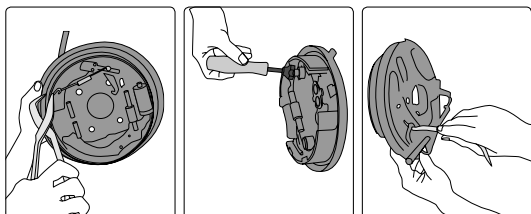

- GB Speedy brake pad compresses  
D Ausdrückvorrichtung für Bremskolben  
PL Wyciskacz do tłoczków hamulcowych  
RUS Приспособление для выдавливания тормозных поршней  
CZ Přípravek k zatlačování brzdových pístů  
H Fékdugattyú visszanyomó  
RO Presă pt. pistoane de frână  
F Repousse piston d'étrier de frein  
I Arretratore manuale per pistoncini freno  
E Expulsor para pistones de frenos  
CN 快速刹车片分离器



15-90  
mm

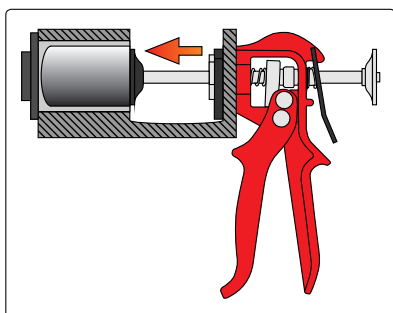

COLOR  
BOX



**YATO**  
YT-0604

16

- GB Disc brake spreader  
D Scheibenbremsen Abscheider  
PL Separator do hamulców tarczowych  
RUS Распорка тормозных дисков  
CZ Přípravek na montáž brzdových prasátek  
H Fékmunkahenger visszanyomó  
RO Separator disc ambreiaj  
F Séparateur des freins à disque  
I Separatore per pistoncini freno  
E Separador de frenos de discos  
CN 刹车片分离器

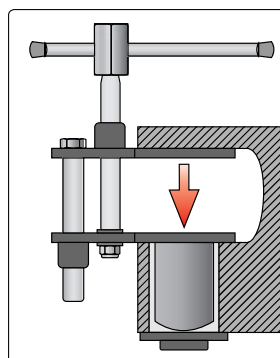

0-65  
mm

1/2" (12.5 mm)  
21 mm

COLOR BOX



**YATO**  
YT-0610

12/24

- GB Disc brake piston tool  
D Bremskolbenrücksteller universal  
PL Uniwersalny klucz do wkręcania zacisków hamulcowych  
RUS Ключ для тормозного поршня  
CZ Univerzální klíč k montáži brzdových třmenů  
H Féknyereg összenyomó

- RO Dispozitiv pt. impins etrier  
F Clé universelle pour pinces de frein  
I Attrezzo per l'arretamento della pinza dei freni  
E Llave para comprimir pistones del freno de disco  
CN 刹车分泵拆装器



for / dla: GM, FORD, Chrysler, VW, Fiat

3/8"  
10mm

CrV

SLIDING  
CARD



**YATO**  
YT-0683

12/96

- GB Disc brake pad & caliper service tool kit
- D Werkzeugsatz von manuellen Separatoren für die Bremsklemmen
- PL Zestaw ręcznych separatorów do zacisków hamulcowych
- RUS Набор ручных сепараторов для тормозных зажимов
- CZ Ruční sada na montáž kotoučových brzd
- H Fékmunkahenger prés készlet
- RO Set de separatoare manuale pt. etrier frâna
- F Set de repousse piston de frein
- I Kit universale regolazione manuale per pistoni freni
- E Juego de separadores manuales para abrazaderas de freno
- CN 刹车片分离器组套

11  
PCS

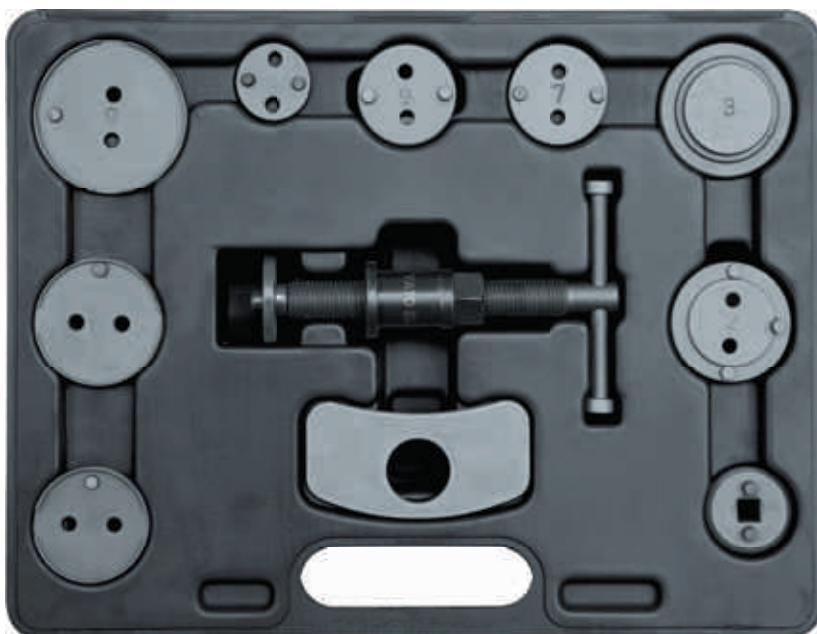

BMC & COLOR SLEEVE

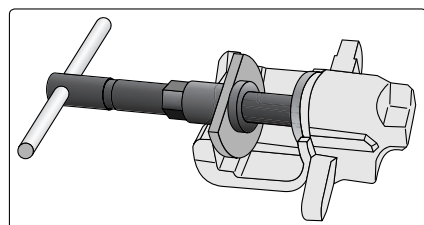

| YATO    | No.            | zacisk przedni (F)  | zacisk tylny (R)                                   |   |
|---------|----------------|---|--|---|
| YT-0681 | 1-1            | siłownik  |  | 5 |
|         | 1              | plytka oporowa  |  |   |
|         | 5              | adapter z gniazdem  |  |   |
|         | 2              | Citroen: XM, Xantia   |  |   |
|         | 3              | Alfa Romeo, Audi, Austin, BMW, Honda, Jaguar, MB, Mitsubishi, Nissan, Rover, Toyota, VW |  |   |
|         | 4              |   | Ford, Mazda, Subaru, Alfa Romeo, Saab              |   |
|         | 6              |   | Nissan   |   |
|         | 7              |   | Audi, Ford, Honda, Nissan, Rover, Saab, Subaru, VW |   |
|         | 8              | General Motors  |  |   |
| 9       | General Motors |   |  |   |

- GB Disc brake pad & caliper service tool kit
- D Werkzeugsatz von manuellen Separatoren für die Bremsklemmen
- PL Zestaw ręcznych separatorów do zacisków hamulcowych
- RUS Набор ручных сепараторов для тормозных зажимов
- CZ Ruční sada na montáž kotoučových brzd
- H Fékmunkahenger prés készlet
- RO Set de separatoare manuale pt. etrier frâna
- F Set de repousse piston de frein
- I Kit universale regolazione manuale per pistoni freni
- E Juego de separadores manuales para abrazaderas de freno
- CN 刹车片分离器组套

12  
PCS

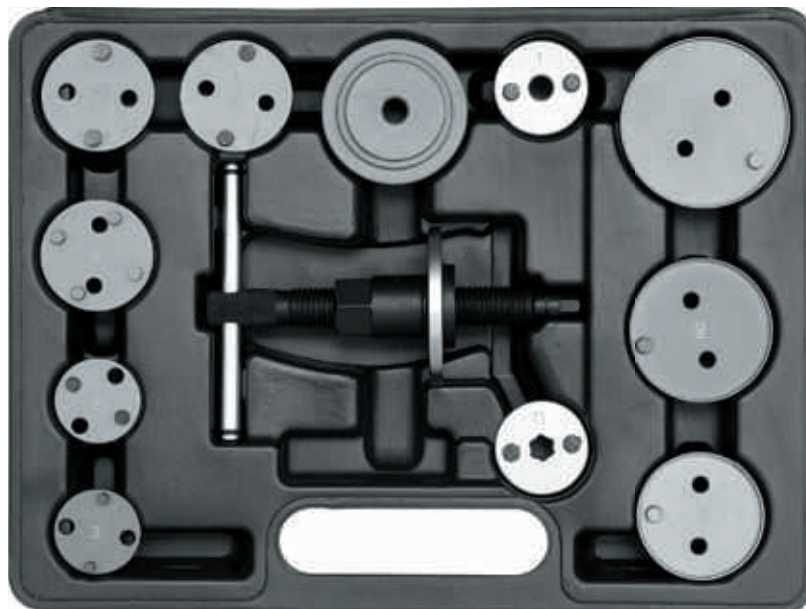

BMC & COLOR SLEEVE

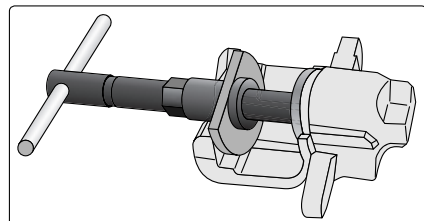

| YATO    | No. | zacisk przedni (F)   | zacisk tylny (R)   |    |
|---------|-----|--|--|----|
| YT-0611 | 0   | General Motors - zaciski 2 1/2" (63.5 mm)  |  | 10 |
|         | 1   | Adapter do przedniego zacisku  |  |    |
|         | 2   | Citroen XM, Xantia (F/R)   |  |    |
|         | 3   |  | Opel (R)   |    |
|         | 4   |  | Ford (R), Mazda (R), Saab (R), Alfa Romeo 164 2.0 (R), Honda (R), General Motors (R) |    |
|         | 5   | Nissan Maxima  |  |    |
|         | 6   |  | Nissan Primera, VW Golf IV   |    |
|         | 7   | Audi (F), Rover, Subaru (F), Ford (F), Nissan (F), Peugeot (F), Toyota (F), VW (F) |  |    |
|         | 8   | General Motors - zaciski 1 7/8" (47.6 mm)  |  |    |
|         | 9   | General Motors - zaciski 2 1/8" (54.0 mm)  |  |    |
|         | 11  |  | Adapter do tylnego zacisku   |    |



- GB Disk brake pad and caliper
- D Pneumatischer Werkzeugsatz für Bremssattelsysteme
- PL Pneumatyczny zestaw do zacisków hamulcowych
- RUS Пневматический набор к тормозным зажимам
- CZ Pneumatická souprava k montáži kotoučových brzd
- H Pneumatikus készlet fék-munkahengerekhez
- RO Ansamblu pneumatic pt. cilindre de frana
- F Set pneumatique aux séparateurs de pinces de frein
- I Kit universale regolazione pneumatico per pistoni freni
- E Juego de herramientas neumaticas para apretadores de frenos
- CN 盘式制动衬块和制动钳

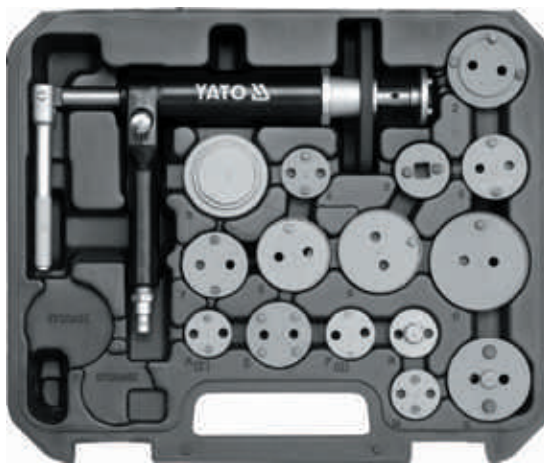
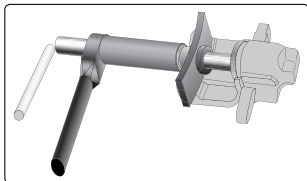

16  
PCS

0.75  
MPa

1/4"  
6.3mm

BMC  
& COLOR  
SLEEVE



| YATO    | No.               | zacisk przedni (F)   | zacisk tylny (R)   |
|---------|-------------------|--|--|
| YT-0671 | 0                 | General Motors - zaciski 2 1/2" (F) (63.5 mm)  |  |
|         | 2                 |  | Citroen XM, Xantia (F/R)   |
|         | 3                 | Audi (F), Alfa Romeo (F), Fiat (F), Ford Fiesta (F), Isuzu (F), Honda Concerto (F), Jaguar (F/R), BMW (F), Mercedes-Benz (F), Mitsubishi Colt (F), Nissan: Almera, Stanza, Sunny (F), Rover (F), Toyota Camry (F), Volvo (F), VW (F) |  |
|         | 4                 |  | Ford (R), Mazda (R), Saab (R), Alfa Romeo 164 2.0 (R), Honda (R), General Motors (R) |
|         | 5                 | Adapter z gniazdem 3/8"  |  |
|         | 6                 |  | Nissan Primera (R), VW Golf IV (R)   |
|         | 7                 |  | Audi (R), Rover, Subaru (R), Ford (R), Nissan (R), Peugeot (R), Toyota (R), VW (R)   |
|         | 8                 | General Motors - zaciski 1 7/8" (47.6 mm)  |  |
|         | 9                 | General Motors - zaciski 2 1/8" (54.0 mm)  |  |
|         | A                 |  | Renault (R)  |
|         | E                 | Nissan Maxima (F/R)  |  |
|         | F                 |  | Opel (R)   |
|         | K                 |  | Citroen (R)  |
|         | M                 |  | Ford (R), Cooper (R)   |
| N       | Saab, Honda (F/R) |  |  |

- GB Disc brake pad & caliper service tool kit
- D Werkzeugsatz von manuellen Separatoren für die Bremsklappen
- PL Zestaw ręcznych separatorów do zacisków hamulcowych
- RUS Набор ручных сепараторов для тормозных зажимов
- CZ Ruční sada na montáž kotoučových brzd
- H Fékmunkahenger prés készlet
- RO Set de separatoare manuale pt. etrier frâna
- F Set de repousse piston de frein
- I Kit universale regolazione manuale per pistoni freni
- E Juego de separadores manuales para abrazaderas de freno
- CN 刹车片分离器组套

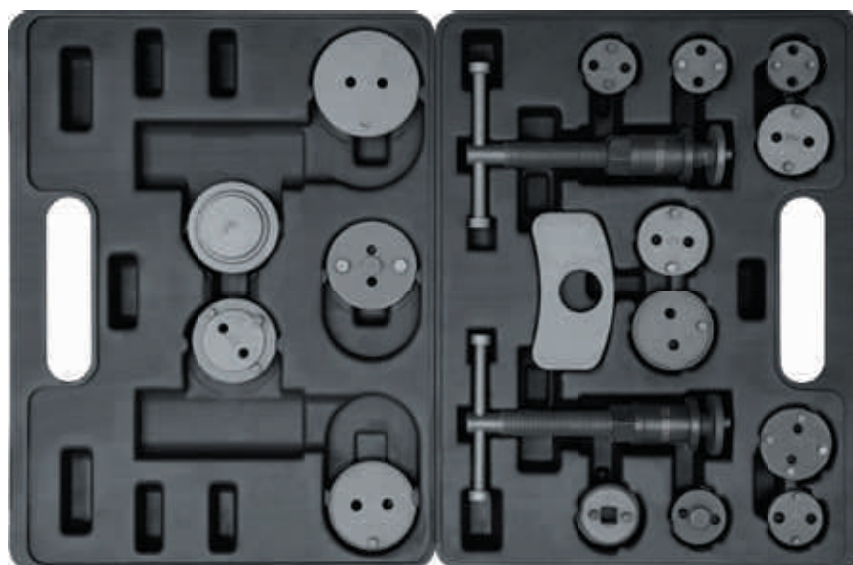
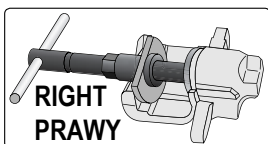
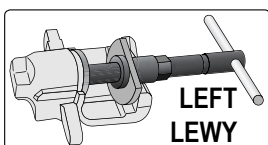

18  
PCS

BMC  
& COLOR  
SLEEVE



| YATO    | No.               | zacisk tylny (R)                   | zacisk tylny (R)   |  |
|---------|-------------------|------------------------------------|--|--|
| YT-0682 | 1-1               | silowniki z lewym i prawym gwintem |  |  |
|         | 1                 | plytka oporowa                     |  |  |
|         | 5                 | 3/8" (10.0 mm)                     | adapter z gniazdem   |  |
|         | 0                 | 2 1/2" (63.5 mm)                   | General Motors   |  |
|         | 2                 | 2 1/64" (51.0 mm)                  | Citroen XM, Xantia   |  |
|         | 3                 | 2 5/32" (55.0 mm)                  | Audi, Alfa Romeo, Fiat, Ford Fiesta, Honda, Jaguar, BMW, Mercedes, Mitsubishi Colt, Nissan, Rover, Auslin, Toyota Camry, Volvo, VW: Passat, Golf GTI | Jaguar   |
|         | 4                 | 1 1/4" (32.0 mm)                   |  | Ford, Mazda, Saab, Alfa Romeo 164, Honda, General Motors |
|         | 6                 | 1 21/32" (42.0 mm)                 |  | Nissan Primera, VW Golf IV                               |
|         | 7                 | 1 21/32" (42.0 mm)                 |  | Audi, Rover, Subaru, Ford, Nissan, Peugeot, Toyota, VW   |
|         | 8                 | 1 7/8" (48.0 mm)                   | General Motors   |  |
|         | 9                 | 2 1/8" (54.0 mm)                   | General Motors, Cadillac   |  |
|         | E                 | 1 21/32" (42.0 mm)                 |  | Nissan Maxima  |
|         | G                 | 1 1/4" (32.0 mm)                   |  | Opel   |
|         | K                 | 2 1/8" (54.0 mm)                   |  | Citroen  |
|         | M                 | 1 1/4" (32.0 mm)                   |  | Ford   |
|         | N                 | 1 1/4" (32.0 mm)                   | Saab, Honda  |  |
| Z       | 1 3/16" (30.0 mm) |                                    | Renault  |  |



- GB Disc brake pad & caliper service tool kit
- D Werkzeugsatz von manuellen Separatoren für die Bremmsklemmen
- PL Zestaw ręcznych separatorów do zacisków hamulcowych
- RUS Набор ручных сепараторов для тормозных зажимов
- CZ Ruční sada na montáž kotoučových brzd
- H Fékmunkahenger prés készlet
- RO Set de separatoare manuale pt. etrier frâna
- F Set de repousse piston de frein
- I Kit universale regolazione manuale per pistoni freni
- E Juego de separadores manuales para abrazaderas de freno
- CN 刹车片分离器组套

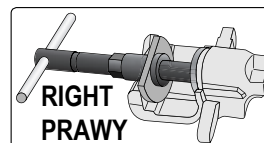
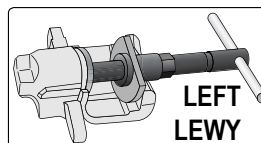

**35**  
PCS  
**3/8"**  
**10mm**

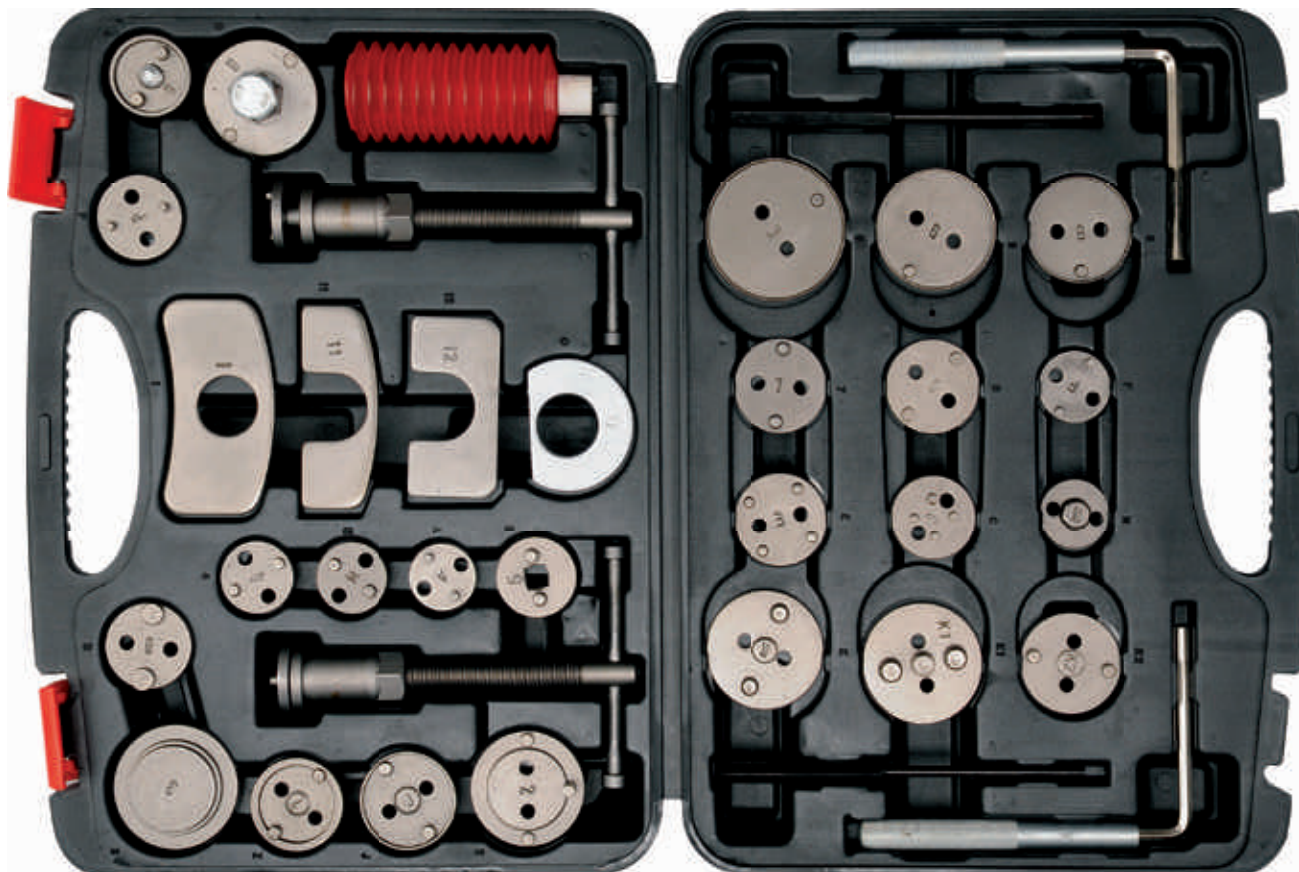

BMC & COLOR SLEEVE



16

| No.       | No.                | zacisk przedni (F)                                       | zacisk tylny (R)  |
|-----------|--------------------|--|---|
| YT-06822  | 2                  | 2 1/64" (51.0 mm)  | Citroen Xantia, Honda Prelude   |
|           | 3                  | 2 5/32" (55.0 mm)  | Fiat, Alfa Romeo, Isuzu, Mercedes Benz, BMW, Citroen, Ford, Honda, Jaguar, Nissan, Peugeot, Rover, Toyota, VAG, Volvo<br>Jaguar |
|           | 4                  | 1 1/4" (32.0 mm)   | Ford, Mazda, Saab, Fiat, Alfa Romeo, General Motors   |
|           | 5                  | 3/8" (10.0 mm)   | adapter z gniazdem  |
|           | 7                  | 1 21/32" (42.0 mm)                                       | Nissan, VAG, Jaguar S   |
|           | 6                  | 1 21/32" (42.0 mm)                                       | Audi, Rover, Subaru, Ford, Nissan, Peugeot, Toyota, VAG, Saab, Jaguar, GM   |
|           | 8                  | 1 7/8" (48.0 mm)   | General Motors  |
|           | 9                  | 2 1/8" (54.0 mm)   | General Motors, Cadillac  |
|           | 0                  | 2 1/2" (63.5 mm)   | General Motors  |
|           | A                  | 1 1/5" (30.5 mm)   | Renault, BMW, Mini  |
|           | B                  | 1 19/30" (41.5 mm)                                       | Ford, Lincoln, Subaru   |
|           | C                  | 1 19/30" (41.5 mm)                                       | Mini, Nissan, Opel, Toyota  |
|           | D                  | 2 1/64" (51.0 mm)  | Renault, Citroen  |
|           | E                  | 1 21/32" (42.0 mm)                                       | Nissan Maxima   |
|           | F                  | 1 1/4" (32.0 mm)   | Opel, Fiat  |
|           | G                  | 3/8" (10.0 mm)   | Peugeot, GM   |
|           | J                  | 1 22/33" (42.5 mm)                                       | Fiat, Alfa Romeo, Audi, Citroen, Renault, Peugeot, Ford, Nissan, Saab, VAG, Subaru, Volvo                                       |
|           | K                  | 2 1/8" (54.0 mm)   | Citroen, Opel   |
|           | K1                 | 2 1/8" (54.0 mm)   | Renault, Citroen  |
|           | K2                 | 1 22/23" (50.0 mm)                                       | Citroen, Renault, Audi  |
| P         | 1 19/30" (41.5 mm) | VAG, BMW, Ford, Lancia, Proton, Renault, Rover, Citroen  |   |
| M         | 1 1/4" (32.0 mm)   | Ford, Mini, Nissan                                       |   |
| N         | 1 1/4" (32.0 mm)   | Saab, Honda, Alfa Romeo, Ford Mondeo, Lancia, Volkswagen |   |
| Z         | 1 3/16" (30.0 mm)  | Ford, Mazda, Mitsubishi, Toyota Corolla                  |   |
| 1, 11, 12 |                    | plytka oporowa   |   |



- GB Coil spring clamp  
D Federspanner  
PL Ściągacz do sprężyn  
RUS Съёмник пружин  
CZ Stahovák pružin  
tlumičů automobilů  
H Rugóösszehúzó
- RO Presa pt. arcuiri  
F Compresseurs de ressort  
I Estrattore per smonta molle  
E Extractor de muelles  
CN 弹簧夹



2 PCS  
1/2" (12.5 mm)  
21 mm

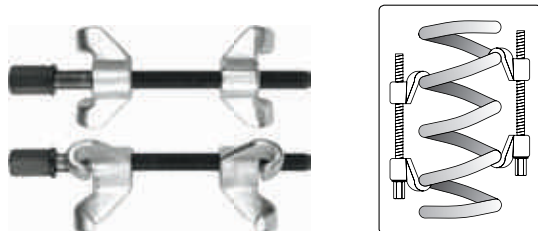

| YATO    | Ø (mm) | L (mm) |      |
|---------|--------|--------|------|
| YT-0605 | 90     | 200    | 5/10 |



CrV

| YATO    | Ø (mm) | L (mm) |   |
|---------|--------|--------|---|
| YT-2544 | 82     | 370    | 8 |

COLD FORGED KUTE NA ZIMNO

| YATO    | Ø (mm) | L (mm) |   |
|---------|--------|--------|---|
| YT-2546 | 82     | 280    | 8 |
| YT-2547 | 82     | 355    | 8 |

- GB Macpherson spring dumper extractor  
D Abziehvorrichtung für Federn von MacPherson  
PL Ściągacz do sprężyn MacPhersona  
RUS Съёмник пружин подвески Макферсона  
CZ Stahovák pružin McPherson  
H MacPerson rugó összehúzó  
RO Extractor de arcuiri MacPherson  
F Compresseurs de ressort MacPherson  
I Estrattore per molle MacPherson  
E Desmontador para los resortes de MacPherson  
CN 弹簧压缩器

CrMo SCM-415

3 POINTS OF FIXING PUNKTY MOCOWANIA

max. 2900 kg

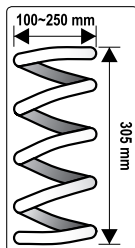

WHITE CARTON BOX & COLOR LABEL

| YATO    |   |
|---------|---|
| YT-2535 | 2 |

- GB Vice for shock absorber  
D Halterung, Schraubstock für die Säule von MacPherson  
PL Uchwyt, imadło do kolumny MacPhersona  
RUS Тиски к подвеске Макферсона  
CZ Upínací přípravek, svěrák na nápravy McPherson  
H Fogantyú, satu MacPerson oszlophoz  
RO Mâner, menghină pt. coloana MacPherson  
F Poignée et étau pour la colonne MacPherson  
I Manico e vice colonna MacPherson  
E Mandril, torno para la columna de MacPherson  
CN 弹簧减震器固定器

35~70 mm



WHITE CARTON BOX & COLOR LABEL

| YATO    |   |
|---------|---|
| YT-2537 | 5 |

- GB Interchangeable fork spring compressor and removal tool  
D Abziehvorrichtung für MacPherson-Federn mit austauschbaren Halterungen  
PL Ściągacz do sprężyn MacPhersona z wymiennymi uchwytami  
RUS Стяжка для снятия пружин Макферсона со сменными полукольцами  
CZ Stahovák pružin McPherson s vyměnitelnými čelistmi  
H MacPerson rugó összehúzó cserélhető pófakkal  
RO Ancoră suspensie MacPherson cu mâner interschimbabile  
F Compresseurs de ressort MacPherson  
I Smonta ammortizzatori per sospensioni MacPherson  
E Extractor de resortes MacPherson con mangos intercambiables  
CN 免拆式减震弹簧压缩器

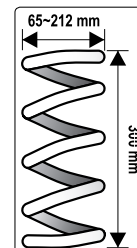

7 PCS

65-125 mm

88-160 mm

max. 1500kg

126-212 mm



BMC & COLOR SLEEVE

| YATO    |   |
|---------|---|
| YT-2536 | 1 |

- GB Drive nut set
- D Stossdämpfer Nutmutter Einsätze
- PL Zestaw nasadek do amortyzatorów
- RUS Набор головок для амортизаторов
- CZ Sada hlavic na uložení tlumiče
- H Lengéscsillapító kiegészítő szet
- RO Set prezoane
- F Set des embouts aux amortisseurs
- I Set di chiavi per aria condizionata
- E Juego de boquillas de amortiguadores
- CN 拆装减震器套件组套

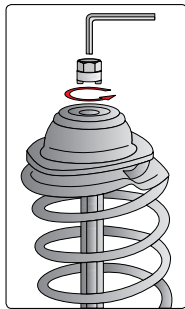

5  
PCS

- No. 1 10.5 mm VW Golf rear
- No. 2 12.5 mm VW Golf front
- No. 3 14.5 mm VW Polo, Golf, Passat, Audi 80
- No. 4 14.5 mm Austin Maestro
- No. 5 14.0 mm Mercedes Benz C-Class (W203)



| YATO    | size / rozmiar (mm)          |       |
|---------|------------------------------|-------|
| YT-0621 | 10.5; 12.5; 14.5; 14.5; 14.0 | 12/48 |

- GB Turnbuckle for shock absorber's top lid
- D Schlüsselsatz zum Befestigen der Stoßdämpfer
- PL Zestaw kluczy do mocowania amortyzatorów
- RUS Набор ключей для крепления амортизаторов
- CZ Sada klíčů k montáži tlumičů
- H Kulcskészlet lengéscsillapítók rögzítéséhez
- RO Set chei pt. fixare amortizoare
- F Set de clés pour amortisseurs
- I Set chiavi per montare ammortizzatori
- E Juego de llaves para la instalación de amortiguadores
- CN 避震器拆卸器

**39** PCS  
**CrMo** SCM415  
**CrV** 6140  
**CrV** 50BV30  
**STEEL** 8660

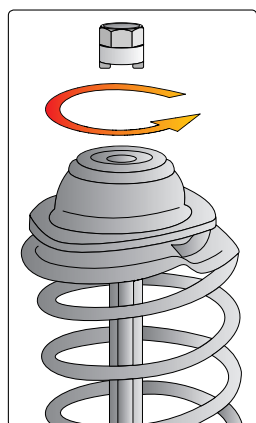

BMC  
& COLOR  
SLEEVE



| YATO    | size / rozmiar (mm) | type of car / model samochodu  | size / rozmiar (mm)   | type of car / model samochodu |
|---------|---------------------|--|---|-------------------------------|
| YT-0628 | 10.5 x 3.5          | VW Golf Rear Axle  | CrV 6140  | D5 Nissan                     |
|         | 12.5 x 3.5          | VW Golf Front Axle   |   | D10 Nissan, Ford              |
|         | 14.5 x 5            | VW Polo, Golf, Passat, Audi 80   |   | 8 Mercedes-Benz               |
|         | 14.5 x 3            | Austin Maestro   |   | 9 Opel/Vauxhall, Chrysler     |
|         | 14 x 2.5            | Mercedenz Benz W203 (C-class), W209 (CLK)                                |   | 10 Chrysler, Ford             |
|         | 14                  | Honda, Nissan  | 11 Japanese Cars  |                               |
|         | 16                  | VW, Audi, Seat, Fiat   | 5 Honda   |                               |
|         | 17                  | Ford, VW, Audi, Seat, Fiat   | 6 Seat, Fiat, Citroen, Peugeot, Ford, Opel, Renault, Japanese Cars, BMW |                               |
|         | 18                  | Ford, VW, Audi, Seat, Rover, Fiat, Opel, Peugeot, Renault, Japanese Cars | 7 VW, Audi, Seat, Citroen, Peugeot, Mercedes-Benz (W203), Renault       |                               |
|         | 19                  | VW, Audi, Seat, Citroen, Fiat, Opel, Peugeot, Toyota                     | 8 Mercedes-Benz   |                               |
|         | 21                  | Mercedenz-Benz W203, Chrysler, VW, Audi, Ford, Japanese Cars             | 3 Mercedes-Benz, Opel, Renault  |                               |
|         | 22                  | VW, Audi, Seat, Citroen, Fiat, Opel, Peugeot, Renault, BMW               | 3.5 Chrysler, Ford, Citroen, Peugeot                                    |                               |
|         | 24                  | Volvo  | 4 Citroen, Peugeot  |                               |
|         | 27                  | VW, Audi, Citroen, Peugeot   |   |                               |
|         | 4                   | Nissan   |   |                               |
|         | 5.2                 | VW, Audi, Nissan   |   |                               |
|         | 6                   | VW, Audi, Renault  |   |                               |
|         | 6.3                 | Nissan   |   |                               |
|         | 7                   | VW, Audi, Seat, Fiat   |   |                               |
|         | 8                   | Seat, Fiat   |   |                               |
| 9       | Japanese Cars       |  |   |                               |
| 10      | Seat, Fiat, Volvo   |  |   |                               |
| 12      | Seat, Fiat          |  |   |                               |

- GB Tire valve stem inserter
- D Abziehvorrichtung für die Gummiventile
- PL Przeciagacz do zaworków gumowych
- RUS Протяжка к резиновым клапанам
- CZ Páka k provlékání bezdušových ventilů
- H Gumiszelep-metsző
- RO Broșă pt. papapele cauciucate
- F Levier tire-valve
- I Brocca valvola di gomma
- E Brocha de tracción para las válvulas de goma
- CN 气门插入工具

SLIDING  
CARD



290  
mm

RUBBER  
VALVES  
ZAWORKY  
GUMOWE



| YATO    | L (mm) |       |
|---------|--------|-------|
| YT-0619 | 290    | 12/72 |



GB Wheel balance pliers  
D Auswuchtgewicht-Zange  
PL Szczypce do wyważania kół  
RUS Клещи для балансировки колес  
CZ Kleště pro vyvažování kol  
H Centírsúly szerelő szerszám  
RO Cleste pt. cauciuc

F Pincas pour le contrepois à agrafe de roue de voiture  
I Pinze per equilibrio ruota  
E Tenazas de equilibrar ruedas  
CN 平衡钳

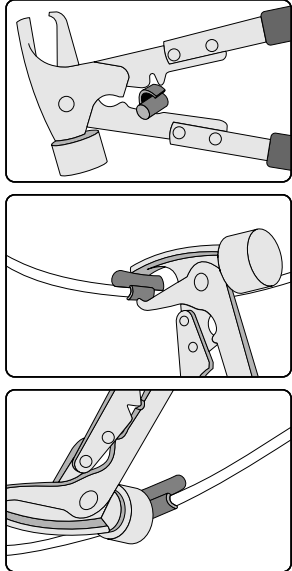

**YATO**  
YT-0643 12/48

GB Wheel balance pliers with cover  
D Auswuchtgewicht-Zange mit Schutzkappe  
PL Szczypce do wyważania kół z osłoną  
RUS Клещи с защитой для балансировки колес  
CZ Kleště pro vyvažování kol s ochranou  
H Centírsúly szerelő szerszám védőkupakkal  
RO Cleste pt. cauciuc cu protectie  
F Pincas pour le contrepois à agrafe de roue de voiture  
I Pinze per equilibrio ruota con protezione  
E Tenazas de equilibrar ruedas, con protector  
CN 平衡钳

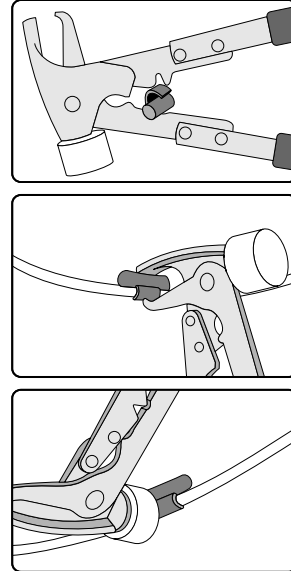

**YATO**  
YT-0644 6/48

GB Deep thin wall impact sockets  
D Schon-Kraftschraubereinsatz für Alufelgen  
PL Zestaw nasadek udarowych do felg aluminiowych  
RUS Набор головок для алюминиевых дисков  
CZ Sada nástrčných klíčů na alu ráfky  
H Hosszított dugókulcs készlet, könnyűfém felnikhez  
RO Dibli de impact cu mufare in interior  
F Set de douilles profondes à choc  
I Set di chiavi a bussola per dadi ruota di alluminio  
E Juego de boquillas de percusión para llantas de aluminio  
CN 风动薄壁长套筒

- for service station and tire workshops
- for maximum impact loads
- drive locks
- ultra thin walls and nylon cover for working with alu rims
- anodised colour finish for fast identification of size
- dla serwisów i warsztatów oponiarskich
- do największych obciążeń udarowych i tętniących
- zamki blokujące
- ultra cienkie ścianki i nylonowe pokrycie do pracy z felgami aluminiowymi
- anodowane kolorowe wykończenie dla szybkiej identyfikacji rozmiaru



3 PCS  
1/2" 12.5mm  
17 19 21 mm  
CrMo SCM-440  
26 29 31 mm  
AS-DRIVE



**YATO**  
YT-1056 1/2" (12.7 mm) 12/24

GB Rubber valve core torque tool  
D Drehmomentwerkzeug für gummi Dichtende Reifventileinsätze  
PL Klucz dynamometryczny do zaworków gumowych  
RUS Ключ динамометрический для резиновых клапанов  
CZ Klíč momentový k montáži gumových ventilů  
H Szeleptűkiszserelő kulcs gumitömítésű szelephez  
RO Surubelnita din plastic pt. supapa  
F Clé dynamométrique pour soupapes  
I Giravite dinamometrica per valvole  
E Llave dinamométrica de válvulas de goma  
CN 定扭橡胶气门芯拆卸工具

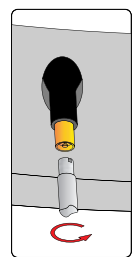

**YATO**  
YT-0795 50/200

GB Metal valve core torque tool  
D Drehmomentwerkzeug für metallisch Dichtende Reifventileinsätze  
PL Klucz dynamometryczny do zaworków metalowych  
RUS Ключ динамометрический для металлических клапанов  
CZ Klíč momentový k montáži kovových ventilů  
H Szeleptűkiszserelő kulcs fémtömítésű szelephez  
RO Surubelnita metalica pt. supapa  
F Clé dynamométrique pour soupapes  
I Giravite dinamometrica per valvole  
E Llave dinamométrica de válvulas de metal  
CN 定扭橡胶气门芯拆卸工具

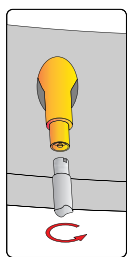

**YATO**  
YT-0796 50/200

- GB Cross rim wrench
- D Kreuzschlüssel
- PL Krzyżakowy klucz do kół
- RUS Ключ-крест балонный
- CZ Klič na kola křížový
- H Kereszt kerékkulcs
- RO Cheie în cruce pt. roți
- F Clé en croix aux roues
- I Chiavi a croce per auto ruota
- E Llave cruz para ruedas
- CN 十字套筒扳手



CrV



PLASTIC HANGER

| YATO    | size / rozmiar                |    |
|---------|-------------------------------|----|
| YT-0800 | 17 x 19 x 21 x 22 mm          | 10 |
| YT-0801 | 17 x 19 x 21 x 1/2" (12.7 mm) | 10 |
| YT-0802 | 24 x 27 x 32 x 3/4" (19.0 mm) | 3  |

- GB T-type sleeved ratchet wrench
- D Radmutter Schlüssel für Autos
- PL Klucz do kół samochodowych
- RUS Ключ к автомобильным колесам
- CZ Klič na kola automobilů
- H Kerékkulcs
- RO Cheie pt. roți de automobile
- F Clé cliquet aux roues
- I Chiavi per ruota auto
- E Llave para las ruedas de automóviles
- CN T型棘轮扳手组套

4 PCS 1/2" 12.5mm

44T CrV 50BV30

AS-DRIVE



PLASTIC HANGER

1/2" (12.7 mm): 17, 19, 21, 23 mm

| YATO    | size / rozmiar |      |
|---------|----------------|------|
| YT-0803 |                | 5/10 |

- GB Wrecking bar
- D Reifenmontierhebel
- PL Łyżka do opon
- RUS Прибор для шиномонтажа
- CZ Montážní páka na pneumatiky
- H Gumiabroncs kar
- RO Levier pt. roti
- F Cuillère à pneus
- I Leva per pneumatici
- E Desmontable para las llantas
- CN 轮胎起子

300 mm 400 mm 500 mm 600 mm CrV

| YATO    | size / rozmiar (mm) |      |
|---------|---------------------|------|
| YT-0807 | 300                 | 20   |
| YT-0808 | 400                 | 20   |
| YT-0809 | 500                 | 5/20 |
| YT-0810 | 600                 | 5/20 |



- GB Tire lever
- D Reifenmontierhebel
- PL Łyżka do opon
- RUS Прибор для шиномонтажа
- CZ Montážní páka na pneumatiky
- H Gumiabroncs kar
- RO Levier pt. roti
- F Cuillère à pneus
- I Leva per pneumatici
- E Desmontable para las llantas
- CN 撬棒

SLIDING CARD

380 mm CrMo



| YATO    | size / rozmiar (mm) |       |
|---------|---------------------|-------|
| YT-0811 | 380                 | 10/50 |

- GB Extra long flexi shaft ratchet
- D Ratsche auf biegsamer Welle
- PL Elastyczny walek z grzechotką
- RUS Вороток к головке с трещоткой
- CZ Ráčna s flexibilní rukojetí
- H Racsnis szár flexibilis hajtással
- RO Prelungitor flexibil pt. bormasina cu clichet
- F Cliquet élastique
- I Albero flessibile con cricchetto
- E Árbol flexible con carraca
- CN 加长定扭棘轮扳手

HALF DOUBLE BLISTER

3/8" 10mm 400 mm 31 Nm

1/4" (6.3 mm) 41T



| YATO    | size / rozmiar |       |
|---------|----------------|-------|
| YT-0726 |                | 10/40 |



- GB Rectangular telescopic inspection mirror  
D Teleskop Inspektionsspiegel  
PL Lusterko inspekcyjne
- RUS Зеркало инспекционное телескопическое  
CZ Zrcátko kontrolní teleskopické  
H Vizsgáló tükör, teleszkópos nyéllel
- RO Oglinda telescopică pt. inspectie  
F Miroir d'inspection  
I Telescopio ispezione specchietto
- E Espejo rectangular telescópico de inspección  
CN 可伸缩矩形检测镜

50x90 mm  
TELESCOPIC HANDLE 285x770 mm



**YATO**  
YT-0660 12/144

- GB LED lighted telescopic inspection mirror  
D Prüfspiegel mit Beleuchtung  
PL Lusterko inspekcyjne z lampką
- RUS Зеркало досмотровое с подсветкой  
CZ Inspekční zrcadélko s lampou  
H Vizsgáló tükör, lámpával
- RO Oglindă pt. inspectie cu lampă  
F Miroir d'inspection avec lampe  
I Specchio di ispezione con lampada
- E Espejo de control con lámpara  
CN 带灯检测镜

265 - 920 mm; Ø54 mm  
TELESCOPIC HANDLE TELESKOPOWY UCHWYT  
**LED**  
STAINLESS STEEL STAL NIERDZEWNA



**YATO**  
YT-0663 10/100

- GB Inspection camera  
D Inspektionskamera  
PL Kamera inspekcyjna  
RUS Контрольная камера  
CZ Inspekční kamera  
H Felügyelő kamera  
RO Cameră de inspectie  
F Camera d'inspection  
I Camera di ispezione  
E Cámara de inspección  
CN 手持式电子可视检查仪



BMC & COLOR SLEEVE  
900 mm  
60°  
12.2 mm  
LED CAMERA LIGHTING OSWIETLACIE KAMERA LED

9V (6LRB1) BATTERY BATERIA  
LCD COLOR SCREEN  
320 x 240 QVGA  
KOLOROWY EKRAŃ LCD

**YATO**  
YT-7291 LCD TFT 2.4" (61 mm) 4



9V (6LRB1) BATTERY BATERIA  
LCD COLOR SCREEN  
320 x 240 QVGA  
KOLOROWY EKRAŃ LCD

**YATO**  
YT-7290 LCD TFT 3.5" (89 mm) 4



LCD COLOR SCREEN  
320 x 240 QVGA  
KOLOROWY EKRAŃ LCD  
Wi-Fi  
3.7V LITHIUM BATTERY AKUMULATOR Li-Polimer

**YATO**  
YT-7292 LCD TFT 3.5" (89 mm) 4

GB Telescopic magnetic pick up tool  
D Teleskop magnet Heber  
PL Chwytyk teleskopowy z magnesem  
RUS Захват магнитный телескопический

CZ Patka teleskopická magnetická  
H Felszedő mágnes, teleszkópos nyéllal  
RO Telescop magnetic  
F Capteur magnétique

I Telescopio magnete  
E Herramienta levantadora magnética, telescópica  
CN 可伸缩磁性拾器



GB Telescopic magnetic pick up tool  
D Teleskop magnet Heber  
PL Chwytyk teleskopowy z magnesem  
RUS Захват магнитный телескопический

CZ Patka teleskopická magnetická  
H Felszedő mágnes, teleszkópos nyéllal  
RO Telescop magnetic  
F Capteur magnétique avec une diode

I Telescopio magnete  
E Herramienta levantadora magnética, telescópica  
CN 可伸缩磁性拾器

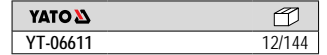

GB Telescopic magnetic pick up tool  
D Teleskop magnet Heber  
PL Chwytyk teleskopowy z magnesem  
RUS Захват магнитный телескопический  
CZ Patka teleskopická magnetická  
H Felszedő mágnes, teleszkópos nyéllal  
RO Telescop magnetic  
F Capteur magnétique telescopique  
I Telescopio a specchio  
E Herramienta levantadora magnética, telescópica  
CN 可伸缩磁性拾器

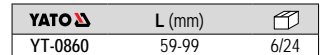

GB Telescopic pick up and mirror set  
D Inspektionssatz: Spiegel + Greifer  
PL Zestaw inspekcyjny: lusterko + chwytyk  
RUS Проверочный набор + держатель и зеркальце  
CZ Inspekční souprava: zrcadlo + držák  
H Teleszkópos ellenőrző készlet: tükör + felvevő  
RO Garnitură de control: oglindă + benă  
F Kit miroir + grappin  
I Set per ispezione: specchio + supporto  
E Juego de inspección: espejo + cuchara de mordazas  
CN 检测镜拾器组套

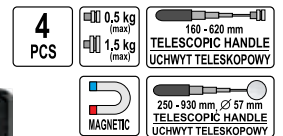

GB Magnetic parts tray  
D Magnetschale  
PL Miska magnetyczna  
RUS Магнитный поднос  
CZ Miska magnetická

H Mágneses tálcá  
RO Tava magnetică  
F Bol magnétique  
I Ciotola magnetica

E Bandeja de accesorios magnética  
CN 磁盘



Ø mm  
110



Ø mm  
150





- GB Magnetic parts tray  
D Magnetschale  
PL Miska magnetyczna  
RUS Магнитный поднос  
CZ Miska magnetická  
H Mágneses tálca  
RO Tava magnetica  
F Bol magnétique  
I Ciotola magnetica  
E Bandeja de accesorios magnética  
CN 磁盘



0,10-0,12  
T  
(TESLA)

Ø mm  
**150**



COLOR  
BOX



|             |    |
|-------------|----|
| <b>YATO</b> |    |
| YT-08305    | 20 |

- GB Magnetic parts tray  
D Magnetschale  
PL Miska magnetyczna  
RUS Магнитный поднос  
CZ Miska magnetická  
H Mágneses tálca  
RO Tava magnetica  
F Bol magnétique  
I Ciotola magnetica  
E Bandeja de accesorios magnética  
CN 磁盘



COLOR BOX



350x150  
mm



|             |      |
|-------------|------|
| <b>YATO</b> |      |
| YT-0831     | 6/12 |

- GB Magnetic tool holder  
D Magnet Werkzeughalter  
PL Listwa magnetyczna  
RUS Магнитная рейка  
CZ Magnetický držák nářadí
- H Mágneses tartó  
RO Suport magnetic  
F Barre et porte  
outil magnétique  
I Striscia magnetica
- E Bandeja de accesorios magnética  
CN 磁性工具架



SLIDING  
CARD

|             |      |
|-------------|------|
| <b>YATO</b> |      |
| YT-0835     | 4/16 |

- GB Tweezer  
D Pinzette  
PL Pęseta  
RUS Пинцет
- CZ Pinzeta  
H Csipesz  
RO Pensetă  
F Pince
- I Pinza  
E Pinzas  
CN 镊子



**140**  
mm

**HRC**  
30

SLIDING  
CARD



**302**  
STAINLESS  
STEEL  
STAL  
NIERDZEWNIA

**ANTI**  
MAGNETIC  
ANTYMAG-  
NETYCZNA

**ANTIACID**  
KWASO-  
ODPORNA

|             |        |        |
|-------------|--------|--------|
| <b>YATO</b> | L (mm) |        |
| YT-6903     | 140    | 20/480 |



**115**  
mm

**HRC**  
30

|             |        |        |
|-------------|--------|--------|
| <b>YATO</b> | L (mm) |        |
| YT-6907     | 115    | 20/480 |



**140**  
mm

**HRC**  
40

|             |        |        |
|-------------|--------|--------|
| <b>YATO</b> | L (mm) |        |
| YT-6916     | 140    | 20/480 |

- GB Workshop creeper  
D Werkstatl-Liege  
PL Leżanka warsztatowa  
RUS Лежак ремонтный  
CZ Lehátko  
H Fekpad gurulos  
RO Targa  
F Chariot de visite  
I Lettino sdraio sotto vettura  
E Camilla de taller  
CN 汽修躺板



**100**  
cm



WHITE  
CARTON BOX  
& COLOR LABEL



|             |   |
|-------------|---|
| <b>YATO</b> |   |
| YT-0880     | 1 |

GB Workshop LED battery lamp  
 D LED Akku-handleuchte  
 PL Diodowa lampa warsztatowa akumulatorowa  
 RUS Аккумуляторный светодиодный светильник для мастерской  
 CZ Ruční svítidla LED  
 H Ledes szerelőlámpa címkeű cikke  
 RO Lampa portabila cu acumulator leduri  
 F Lampe baladeuse  
 I Lampada per officina spaccata  
 E Linterna LED recargable  
 CN 可充式LED手电筒

**1+1 LED**  
**180 lm**  
**3.7V 3600mAh Li-Ion!**  
**230V~50Hz BATTERY CHARGER LADOWARKA**  
 CHARGING TIME: 4 h  
 WORK TIME: 3 h / 2 LED  
**HOOK HAK**  
**MAGNETIC**  
**LED**



**YATO**  
 YT-08502 12



GB Workshop LED battery lamp  
 D LED Akku-handleuchte  
 PL Diodowa lampa warsztatowa akumulatorowa  
 RUS Аккумуляторный светодиодный светильник для мастерской  
 CZ Ruční svítidla LED  
 H Ledes szerelőlámpa címkeű cikke  
 RO Lampa portabila cu acumulator leduri  
 F Lampe néon  
 I Lampada neon  
 E Linterna LED recargable  
 CN 可充式LED手电筒

**3+1 LED**  
**250 lm**  
**2** LIGHTING OPTIONS / Opcje świecenia  
**IP64**  
**3.7V 3600mAh Li-Ion!**  
**230V~50Hz BATTERY CHARGER LADOWARKA**  
 CHARGING TIME: 4.5 h  
 WORK TIME: 3 h / 3 LED  
**HOOK HAK**  
**MAGNETIC**  
**LED**



**YATO**  
 YT-08561 20



GB Workshop LED battery lamp  
 D LED Akku-handleuchte  
 PL Diodowa lampa warsztatowa akumulatorowa  
 RUS Аккумуляторный светодиодный светильник для мастерской  
 CZ Ruční svítidla LED  
 H Ledes szerelőlámpa címkeű cikke  
 RO Lampa portabila cu acumulator leduri  
 F Lampe d'inspection  
 I Torcia ispezione  
 E Linterna LED recargable  
 CN 可充式LED手电筒

**8 LED**  
**80 lm**  
**1.5V 3x AAA!**  
**20 h**  
**LED**



**YATO**  
 YT-08514 12/12



GB Workshop LED battery lamp  
 D LED Akku-handleuchte  
 PL Diodowa lampa warsztatowa akumulatorowa  
 RUS Аккумуляторный светодиодный светильник для мастерской  
 CZ Ruční svítidla LED  
 H Ledes szerelőlámpa címkeű cikke  
 RO Lampa portabila cu acumulator leduri  
 F Lampe baladeuse  
 I Lampada per officina spaccata  
 E Linterna LED recargable  
 CN 可充式LED手电筒

**8+1 LED**  
**280 lm**  
**3** LIGHTING OPTIONS / Opcje świecenia  
**1.5V 3x AA!**  
**4 h**  
**LED**



**YATO**  
 YT-08513 50





GB Workshop LED battery lamp  
D LED Akku-handleuchte  
PL Diodowa lampa warsztatowa akumulatorowa  
RUS Аккумуляторный светодиодный светильник для мастерской  
CZ Ruční svítidla LED  
H Ledes szerelőlámpa címkéjű cikkek  
RO Lampa portabila cu acumulator leduri  
F Lampe baladeuse  
I Lampada led per autofficina  
E Linterna LED recargable  
CN 可充長款針腳



|  |                                      |   |
|--|--------------------------------------|---|
| <b>27</b><br>LED                             | <b>13000</b><br>MCD                  | <b>3.6V</b><br>1200mAh<br>Ni-MH               |
| 230V~50Hz<br>BATTERY<br>CHARGER<br>LADOWARKA | WATER<br>PROOF<br>ODPORNA<br>NA WODĘ | CHARGING TIME<br>CZAS LADOWANIA<br><b>4 h</b> |
|  |                                      |   |
|  |                                      |   |
| <b>LED</b>                                   |                                      |   |



**YATO**  
YT-08523 10



GB Workshop LED battery lamp  
D LED Akku-handleuchte  
PL Diodowa lampa warsztatowa akumulatorowa  
RUS Аккумуляторный светодиодный светильник для мастерской  
CZ Ruční svítidla LED  
H Ledes szerelőlámpa címkéjű cikkek  
RO Lampa portabila cu acumulator leduri  
F Lampe baladeuse  
I Lampada per officina spaccata  
E Linterna LED recargable  
CN 可充長款針腳



|  |   |                                      |
|--|---|--------------------------------------|
| <b>30/7</b><br>LED                           | <b>13000</b><br>MCD                             | <b>3.6V</b><br>1200mAh<br>Ni-MH      |
| 230V~50Hz<br>BATTERY<br>CHARGER<br>LADOWARKA | CHARGING TIME<br>CZAS LADOWANIA<br><b>4-5 h</b> | WATER<br>PROOF<br>ODPORNA<br>NA WODĘ |
|  |   |                                      |
|  |   |                                      |
| <b>LED</b>                                   |   |                                      |



**YATO**  
YT-08505 10



GB Rechargeable work lamp  
D Led Werkstattlampe  
PL Diodowa lampa warsztatowa  
RUS Светодиодная беспроводная лампа  
CZ Montážní lampa diodová bezpřívodová  
H Ledlámpa  
RO Lampa cu led fara cablu  
F Lampe baladeuse  
I Lampada led per autofficina  
E Lámpara inalámbrica de diodos  
CN 可充电工作灯



|                           |                  |             |
|---------------------------|------------------|-------------|
| <b>4</b><br>LED           | <b>400</b><br>lm | <b>IP65</b> |
| WIRE<br>PREZEWÓD<br>4.9 m | HOOK<br>HAK      |             |
| <b>LED</b>                |                  |             |



**YATO**  
YT-08531 10

GB Rechargeable work lamp  
D Led Werkstattlampe  
PL Diodowa lampa warsztatowa  
RUS Светодиодная беспроводная лампа  
CZ Montážní lampa diodová bezpřívodová  
H Ledlámpa  
RO Lampa cu led fara cablu  
F Lampe baladeuse  
I Lampada led per autofficina  
E Lámpara inalámbrica de diodos  
CN 可充电工作灯



|  |                                      |                                |
|--|--------------------------------------|--------------------------------|
| <b>60+1</b><br>LED                           | <b>13000</b><br>MCD                  | <b>7.2V</b><br>800mAh<br>Ni-MH |
| 230V~50Hz<br>BATTERY<br>CHARGER<br>LADOWARKA | WATER<br>PROOF<br>ODPORNA<br>NA WODĘ |                                |
|  |                                      |                                |
|  |                                      |                                |
| <b>LED</b>                                   |                                      |                                |



**YATO**  
YT-0852 5/20

GB Under bonnet work led lamp  
 D Led Werkstattlampe  
 PL Diodowa lampa warsztatowa do oświetlenia komory silnika  
 RUS Светодиодная беспроводная лампа  
 CZ Montážní lampa diodová bezpřívodová

H Ledlámpa  
 RO Lampa cu led fara cablu  
 F Rampe d'éclairage  
 I Lampada led trasportabile per illuminazione di vani motore  
 E Lámpara inalámbrica de diodos  
 CN 引擎盖检修灯

|                                     |                                    |                                  |
|-------------------------------------|------------------------------------|----------------------------------|
| 100 LED                             | 600 lm                             | 7.4V 2000mAh Li-Ion              |
| 230V~50Hz BATTERY CHARGER LADOVARKA | CHARGING TIME CZAS ŁADOWANIA 3-4 h | WORK TIME CZAS PRACY 4 h 100 LED |
| HOOK HAK                            |                                    | MAGNETIC                         |

LED

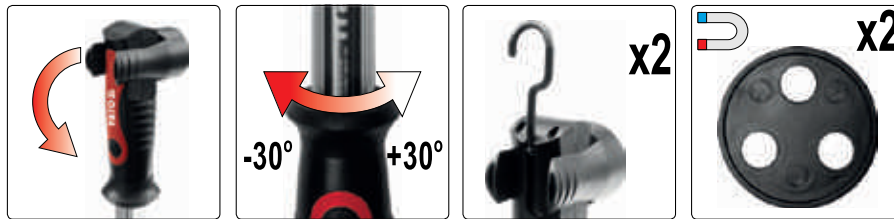

COLOR BOX

**YATO**

YT-08503 9

GB Under bonnet work led lamp  
 D Led Werkstattlampe  
 PL Diodowa lampa warsztatowa do oświetlenia komory silnika  
 RUS Светодиодная беспроводная лампа  
 CZ Montážní lampa diodová bezpřívodová

H Ledlámpa  
 RO Lampa cu led fara cablu  
 F Rampe d'éclairage  
 I Lampada led trasportabile per illuminazione di vani motore  
 E Lámpara inalámbrica de diodos  
 CN 引擎盖检修灯



|                                    |                                     |                                 |               |
|------------------------------------|-------------------------------------|---------------------------------|---------------|
| 120 LED                            | 13000 MCD                           | 60 LED                          | 120 LED       |
| 7.2V 1800mAh Ni-MH                 | 230V~50Hz BATTERY CHARGER LADOVARKA | WORK TIME CZAS PRACY 8 h 60 LED | 4 h (120 LED) |
| CHARGING TIME CZAS ŁADOWANIA 4-5 h |                                     | HOOK HAK                        | MAGNETIC      |

LED

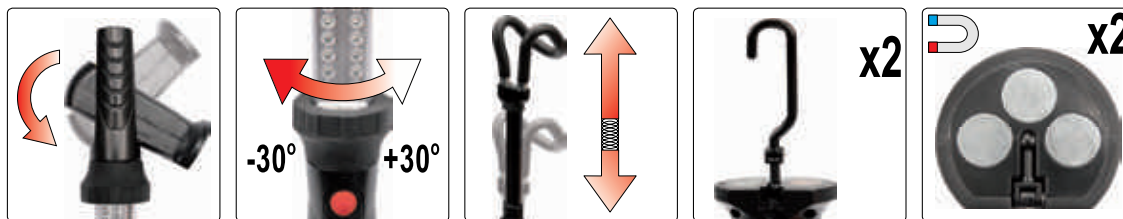

COLOR BOX

**YATO**

YT-08530 4

GB Disposable breathalyzer  
 D Alkoholtester  
 PL Alkomat jednorazowy  
 RUS Алкотестер  
 CZ Alkohol tester  
 H Alkoholszonda  
 RO Alcoolmetru  
 F Alcotest  
 I Etilometro monouso  
 E Alcoholímetro  
 CN 酒精测试仪



PLASTIC BAG 30 PCS

DISPLAY COLOR BOX

**YATO**

YT-73310 900

- results in 2 min
  - accuracy 99%
  - meets NF and TÜV standards
  - user-friendly
  - not includes carcinogenic potassium dichromate
  - with two plastic mouthpieces
- test w 2 min
  - dokładność 99%
  - spełnia normy NF i TÜV
  - prosty w obsłudze
  - nie zawiera rakotwórczego dichromianu potasu
  - z dwoma plastikowymi ustnikami

**YATO**

YT-73310 900



- GB Automotive circuit tester  
D KFZ Prüflampe  
PL Wskaźnik elektryczny samochodowy  
RUS Пробник напряжения автомобильный  
CZ Zkoušečka napětí autoelektrikářská  
H Próbálampa

- RO Tester pt. circuite auto  
F Testeur de tension de voiture  
I Tester elettrico per auto  
E Indicador eléctrico de coche  
CN 汽车测电笔

SLIDING  
CARD



CABLE  
KABEL  
90 cm



6-24 V

|             |        |  |
|-------------|--------|--|
| <b>YATO</b> |        |  |
| YT-2865     | 10/250 |  |



6-12 V

|             |        |  |
|-------------|--------|--|
| <b>YATO</b> |        |  |
| YT-2866     | 10/100 |  |

- GB Number stamp  
D Nummernstempel  
PL Znaczniki cyfrowe  
RUS Клейма цифровые  
CZ Razidla číselná  
H Számbeütők  
RO Poansoane cu cifre  
F Chiffres à frapper  
I Punzoni marcatori  
E Marcadores de números  
CN 数字冲模

9 PCS  
NUMBERS  
NUMERY  
0 - 9  
1045  
CARBON  
STEEL  
HRC  
50-55



PLASTIC BOX  
& COLOR SLEEVE

| <b>YATO</b> | No (mm) | PCS<br>packing: |    |
|-------------|---------|-----------------|----|
| YT-6854     | 6       | 9               | 20 |
| YT-6855     | 8       | 9               | 18 |

- GB Letter stamp  
D Buchstabenstempel  
PL Znaczniki literowe  
RUS Клейма буквенные  
CZ Razidla písmenová  
H Betűbetűtők  
RO Poansoane cu litere  
F Lettres à frapper  
I Punzoni marcatori  
E Marcadores de letras  
CN 字母冲模

27 PCS  
LETTERS  
LITERY  
A - Z &  
1045  
CARBON  
STEEL  
HRC  
50-55



PLASTIC BOX  
& COLOR SLEEVE

| <b>YATO</b> | No (mm) | PCS<br>packing: |    |
|-------------|---------|-----------------|----|
| YT-6862     | 6       | 27              | 12 |
| YT-6863     | 8       | 27              | 8  |

- GB Thread repair set  
D Reparatursatz für Gewinde  
PL Zestaw do naprawy gwintów  
RUS Набор для ремонта резьбы  
CZ Souprava na opravu závitů  
H Menetjavító készlet  
RO Set pt. reparare filete  
F Set d'helicoils  
I Kit di riparazione per filettature  
E Juego para reparar roscas  
CN 螺纹修复组套



METAL BOX  
& COLOR BOX

HSS  
4341  
STAINLESS  
STEEL  
MERCELEWNA

88  
PCS

| <b>YATO</b> | size / rozmiar      |      |
|-------------|---------------------|------|
| YT-1769     | M6 x 1.0 x 10.8 mm  | 5/10 |
|             | M8 x 1.25 x 10.8 mm |      |
|             | M10 x 1.5 x 13.5 mm |      |



131  
PCS

| <b>YATO</b> | size / rozmiar       |      |
|-------------|----------------------|------|
| YT-1763     | M5 x 0.8 x 6.7 mm    | 5/10 |
|             | M6 x 1.0 x 10.8 mm   |      |
|             | M8 x 1.25 x 10.8 mm  |      |
|             | M10 x 1.5 x 13.5 mm  |      |
|             | M12 x 1.75 x 16.3 mm |      |

- GB Wire threads  
D Spiraleinlagen für Gewindereparatur  
PL Wkłady spiralne do naprawy gwintów  
RUS Метчики и сверла для ремонта резьбы  
CZ Spirálové vložky na opravu závitů  
H Menetjavító betétek

- RO Insertii spirală pt. reparare filete  
F Helicoil  
I Inserti a spirale per riparazione  
E Elementos espirales para reparar roscas  
CN 不锈钢螺纹套

POLYBAG  
WITH  
HEADER



for / dla: YT-1763, YT-1769

STAINLESS  
STEEL  
MERCELEWNA



| <b>YATO</b> | size / rozmiar       | PCS<br>packing: |        |
|-------------|----------------------|-----------------|--------|
| YT-1764     | M5 x 0.8 x 6.7 mm    | 20              | 50/250 |
| YT-1765     | M6 x 1.0 x 10.8 mm   | 20              | 50/250 |
| YT-1766     | M8 x 1.25 x 10.8 mm  | 20              | 50/200 |
| YT-1767     | M10 x 1.5 x 13.5 mm  | 15              | 25/100 |
| YT-1768     | M12 x 1.75 x 16.3 mm | 10              | 25/100 |

- GB Dual foot tire gauge
- D Reifendruckprüfer
- PL Ciężniomierz do aut ciężarowych
- RUS Манометр для грузовых автомобилей
- CZ Tlakomer na nákladní auta
- H Nyomásmérő tehergépkocsikhoz
- RO Indicator de presiune pt. camioane
- F Manometre pneu pour camions
- I Manometro per automezzi
- E Manómetro de caomones
- CN 胎压表



SLIDING CARD



|             |        |
|-------------|--------|
| <b>YATO</b> |        |
| YT-24301    | 25/100 |

- GB Foot pump with gauge
- D Fusspumpe
- PL Pompka nożna z manometrem
- RUS Насос ножный с манометром
- CZ Nožní pumpa z manometrem
- H Lábpumpa nyomásmérővel
- RO Pompă de picior cu manometru
- F Pompe à pied avec manomètre
- I Pompa a pedale con manometro
- E Bomba de pierna con manometro
- CN 打气筒



- GB Hand pump with manometer
- D Hand-Luftpumpe mit Manometer
- PL Pompka słupkowa z manometrem
- RUS Насос ручной с манометром
- CZ Pumpa z manometrem
- H Kézi pumpa manométerrel
- RO Pompa de mana cu manometru
- F Pompe manuelle avec manomètre
- I Pompa verticale con manometro
- E Bomba de barrote con manometro
- CN 带压力表打气筒



COLOR BOX



|             |    |
|-------------|----|
| <b>YATO</b> |    |
| YT-7349     | 10 |

- GB Foot pump with gauge
- D Fusspumpe
- PL Pompka nożna z manometrem
- RUS Насос ножный с манометром
- CZ Nožní pumpa z manometrem
- H Lábpumpa nyomásmérővel
- RO Pompă de picior cu manometru
- F Pompe à pied avec manomètre
- I Pompa a pedale con manometro
- E Bomba de pierna con manometro
- CN 打气筒



TWIN PISTON  
PODWÓJNY TŁOK



COLOR BOX



|             |    |
|-------------|----|
| <b>YATO</b> |    |
| YT-7350     | 10 |



PLASTIC HANGER & TAG CARD





|             |   |
|-------------|---|
| <b>YATO</b> |   |
| YT-7352     | 6 |



GB Funnel  
D Trichter  
PL Lejek  
RUS Воронка гибкая  
CZ Nálevka  
H Kétrészes tölcser  
RO Pálnie  
F Entonnoir  
I Imbuto  
E Embudo  
CN 漏斗



∅  
**135mm**  
PP

| YATO  | ∅ (mm) |  |
|--|--------|---|
| YT-0694  | 135    | 192   |

GB Long funnel  
D Trichter  
PL Lejek dlugi  
RUS Воронка гибкая  
CZ Nálevka  
H Kétrészes tölcser  
RO Pálnie  
F Entonnoir  
I Imbuto  
E Embudo  
CN 漏斗





∅  
**120mm**  
PP

| YATO  | L (mm) | ∅ (mm) |  |
|--|--------|--------|---|
| YT-0693  | 455    | 120    | 48  |

GB Operating fluids funnel  
D Trichter  
PL Lejek do płynów eksploatacyjnych  
RUS Воронка гибкая  
CZ Nálevka  
H Kétrészes tölcser  
RO Pálnie  
F Entonnoir  
I Imbuto  
E Embudo  
CN 漏斗





∅  
**100mm**  
PP

| YATO  | ∅ (mm) |  |
|--|--------|---|
| YT-0695  | 100    | 180   |

GB Operating fluids funnel  
D Trichter  
PL Lejek do płynów eksploatacyjnych  
RUS Воронка гибкая  
CZ Nálevka  
H Kétrészes tölcser  
RO Pálnie  
F Entonnoir  
I Imbuto  
E Embudo  
CN 漏斗





∅  
**240mm**  
PP

| YATO  | ∅ (mm) |  |
|--|--------|---|
| YT-0696  | 240    | 48  |

GB Fuel and oil funnel  
D Trichter  
PL Lejek do paliwa i oleju eksploatacyjnych  
RUS Воронка гибкая  
CZ Nálevka  
H Kétrészes tölcser  
RO Pálnie  
F Entonnoir pour essence et huile  
I Imbuto  
E Embudo  
CN 漏斗





∅  
**150mm**  
PP

| YATO  | ∅ (mm) |  |
|--|--------|---|
| YT-0692  | 150    | 30  |

GB Oil funnel  
D Trichter  
PL Lejek do oleju  
RUS Воронка гибкая  
CZ Nálevka  
H Kétrészes tölcser  
RO Pálnie  
F Entonnoir  
I Imbuto  
E Embudo  
CN 漏斗





∅  
**280mm**  
PP

| YATO  | ∅ (mm) |  |
|--|--------|---|
| YT-0697  | 280    | 48  |

GB Oil drain pan  
D Ölwanne  
PL Miska do oleju  
RUS Миска для масла  
CZ Miska na olej  
H Fáradtolaj felfogó edény  
RO Recipient pt. ulei  
F Bol à l'huile  
I Vaschetta per cambio olio  
E Escudilla para aceite  
CN 接油盆





PP

| YATO  | l | ∅ (cm) |  |
|--|---|--------|---|
| YT-0699  | 8 | 37     | 48  |



PE

| YATO  | l  | ∅ (cm) |  |
|--|----|--------|---|
| YT-0716  | 10 | 37     | 6   |
| YT-0717  | 15 | 42     | 4   |

GB Oil drainer  
D Öleinfüllanlage  
PL Zlewarka do oleju  
RUS Устройство для слива масла  
CZ Olejová nádrž s odsáváním  
H Fáradtolaj leszívó  
RO Dispozitiv pt. schimbat ulei  
F Récupérateur d'huile  
I Scolapiatti dell'olio  
E Decantador para aceite  
CN 泄油器



75-155 cm  
PE

WHITE CARTON BOX & COLOR LABEL



| YATO  | l  | ∅ (cm) |  |
|--|----|--------|---|
| YT-0718  | 20 | 42     | 1   |

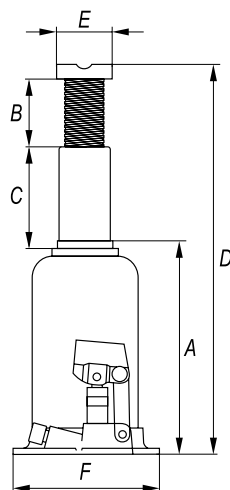

- GB Hydraulic bottle jack
- D Hydraulischer Stempelwagenheber
- PL Podnośnik hydrauliczny słupkowy
- RUS Домкрат гидравлический
- CZ Pístový zvedák hydraulický
- H Hidraulikus emelő
- RO Cric hidraulic
- F Elévateur
- I Cric idraulico a bottiglia
- E Gato de embolo hidr.
- CN 立式液压千斤顶



ELECTROLESS  
NICKEL  
PLATING

COLOR BOX



| YATO  | T  | A (mm) | B (mm) | C (mm) | D (mm) | E (mm) | F (mm)    |  |
|--|----|--------|--------|--------|--------|--------|-----------|---|
| YT-1702  | 5  | 212    | 110    | 146    | 468    | 40     | 110x112   | 5   |
| YT-1704  | 10 | 220    | 115    | 148    | 483    | 48     | 124x127.5 | 3   |
| YT-1706  | 15 | 231    | 113    | 154    | 498    | 56     | 140x142   | 2   |
| YT-1707  | 20 | 241    | 115    | 165    | 521    | 60     | 165x161   | 2   |
| YT-1709  | 30 | 244    | 108    | 140    | 492    | 65     | 186x174   | 1   |

- GB Two-piston hydraulic bottle jack
- D Hydraulischer Stempelwagenheber
- PL Podnośnik hydrauliczny słupkowy dwutłokowy
- RUS Домкрат гидравлический
- CZ Pístový zvedák hydraulický
- H Hidraulikus emelő
- RO Cric hidraulic
- F Elévateur deux niveaux
- I Cric idraulico a bottiglia
- E Gato de embolo hidr.
- CN 液压双级千斤顶





**5t**  
500  
↑  
220 mm

| YATO  | T |  |
|--|---|---|
| YT-1711  | 5 | 2   |



**10t**  
225  
↑  
125 mm

| YATO  | T  |  |
|--|----|---|
| YT-1713  | 10 | 2   |



COLOR BOX



ELECTROLESS  
NICKEL  
PLATING





**10t**  
523  
↑  
208 mm

| YATO  | T  |  |
|--|----|---|
| YT-1714  | 10 | 1   |



**12t**  
593  
↑  
230 mm

| YATO  | T  |  |
|--|----|---|
| YT-1715  | 12 | 1   |



- GB Hydraulic floor jack
- D Hydraulischer Rangierwagenheber
- PL Podnośnik hydrauliczny
- RUS Домкрат гидравлический
- CZ Pístový zvedák hydraulický
- H Hidraulikus emelő
- RO Cric tip crocodil
- F Elévateur hydraulique
- I Sollevatore idraulico
- E Gato de embolo hidr.
- CN 卧式液压千斤顶



LOW PROFILE

1.25t

375 mm  
80 mm

AI

COLOR BOX



|             |      |   |
|-------------|------|---|
| <b>YATO</b> | T    |   |
| YT-1719     | 1.25 | 1 |



2t

359 mm  
89 mm

BMC & COLOR SLEEVE



|             |   |   |
|-------------|---|---|
| <b>YATO</b> | T |   |
| YT-1720     | 2 | 1 |



2.5t

457 mm  
89 mm

COLOR BOX



|             |     |   |
|-------------|-----|---|
| <b>YATO</b> | T   |   |
| YT-1721     | 2.5 | 1 |

- GB Work bench
- D Lackierständer, verstellbar
- PL Stojak lakierniczy rozstawny
- RUS Раздвижная лакировочная стойка
- CZ Stojan lakýrnický rozkládací
- H Kinyitható lakkozó állvány

- RO Suport extensibil pt. lacuit
- F Support à peindre
- I Supporto pieghevole
- E Montante plegable para barnizar
- CN 工作台

10 kg max  
50 cm  
85 cm

150 kg max  
100 cm  
45 cm



COLOR BOX

|             |   |
|-------------|---|
| <b>YATO</b> |   |
| YT-5555     | 1 |

- GB Refractometer
- D Refraktometer
- PL Refraktometr
- RUS Рефрактометр
- CZ Refraktometer
- H Refraktometria

- RO Refractometrul
- F Réfractomètre
- I Rifrattometro
- E Refractometro
- CN 冰点仪



PLASTIC BOX & COLOR SLEEVE

|             |    |
|-------------|----|
| <b>YATO</b> |    |
| YT-06722    | 20 |

- GB Electronic battery charger
- D Elektronisches Ladegerät
- PL Prostownik elektroniczny
- RUS Электронное зарядное устройство
- CZ Elektronická nabíječka
- H Elektronikus akkumulátortöltő
- RO Redresor electric
- F Chargeur de batterie voiture
- I Avviatore elettronico
- E Rectificador electrónico
- CN 蓄电池充电器



COLOR BOX



|                               |                  |
|-------------------------------|------------------|
| 6 V                           | 1 A              |
| 12 V                          | 4 A              |
| 200 Ah max                    | 230V~50Hz        |
| WET GEL AGM                   | MOKRY ŽELOWY AGM |
| MICROPROCESSOR MICROPROCESSOR |                  |

|             |   |
|-------------|---|
| <b>YATO</b> |   |
| YT-8300     | 8 |



|                               |                  |
|-------------------------------|------------------|
| 230V~50Hz                     | 5-160 Ah         |
| 2 A                           | 12 V             |
| 8 A                           |                  |
| WET GEL AGM                   | MOKRY ŽELOWY AGM |
| MICROPROCESSOR MICROPROCESSOR |                  |



|                               |                  |
|-------------------------------|------------------|
| 6 V                           | 8 A              |
| 12 V                          |                  |
| 5-200 Ah                      | 230V~50Hz        |
| WET GEL AGM                   | MOKRY ŽELOWY AGM |
| MICROPROCESSOR MICROPROCESSOR |                  |

|             |    |
|-------------|----|
| <b>YATO</b> |    |
| YT-83016    | 12 |

|             |   |
|-------------|---|
| <b>YATO</b> |   |
| YT-8301     | 8 |

- GB Electronic battery charger
  - D Elektronisches Ladegerät
  - PL Prostownik elektroniczny
  - RUS Электронное зарядное устройство
  - CZ Elektronická nabíječka
- H Elektronikus akkumulátortöltő
  - RO Redresor electric
  - F Chargeur de batterie voiture
  - I Avviatore elettronico
  - E Rectificador electrónico
  - CN 蓄电池充电器

COLOR BOX



|                               |           |
|-------------------------------|-----------|
| 12 V                          | 12 A      |
| 6-200 Ah                      | 230V~50Hz |
| MICROPROCESSOR MICROPROCESSOR |           |
| WET MOKRY                     |           |

|             |   |
|-------------|---|
| <b>YATO</b> |   |
| YT-8302     | 8 |



|                               |             |
|-------------------------------|-------------|
| 12 V                          |             |
| 15 A                          | 6-200 Ah    |
| 230V~50Hz                     | WET GEL AGM |
| MICROPROCESSOR MICROPROCESSOR |             |
| MOKRY ŽELOWY AGM              |             |

|             |   |
|-------------|---|
| <b>YATO</b> |   |
| YT-8303     | 8 |



GB Battery charger with a starter F Chargeur de batterie  
D Ladegerät mit starterfunktion voiture support demarrage  
PL Prostownik z rozruchem I Caricabatteria con avviamento  
RUS Выпрямитель с функцией запуска E Rectificador con arranque  
CZ Nabíječka s funkcí startování motoru CN 蓄电池充电器  
H Akkumulátortöltő - indító  
RO Redresor cu pomire

COLOR BOX



230V~ 50Hz 12V 24V



16 A 120-240 Ah WET MOKRY

25 A 170-350 Ah WET MOKRY



**YATO**   YT-8304 2



**YATO**   YT-8305 2



15 A 10-300 Ah WET MOKRY AGM BOOST ROZRUCH 12V 75 A 

30 A  50-600 Ah WET MOKRY AGM BOOST ROZRUCH 12V 145 A

**YATO**   YT-83051 2

**YATO**   YT-83052 2

GB Battery charger with a starter RO Redresor cu pomire  
D Ladegerät mit starterfunktion F Chargeur de batterie  
PL Prostownik z rozruchem voiture support demarrage  
RUS Выпрямитель с функцией запуска I Caricabatteria con avviamento  
CZ Nabíječka s funkcí startování motoru E Rectificador con arranque  
H Akkumulátortöltő - indító CN 蓄电池充电器

GREY CARTON BOX & COLOR LABEL



230V~ 50Hz WET MOKRY



12V 27 A START ROZRUCH 300 A

24V 25 A START ROZRUCH 240 A

20-600 Ah

12V 32 A START ROZRUCH 390 A

24V 31 A START ROZRUCH 360 A

20-700 Ah

12V 38 A START ROZRUCH 540 A

24V 35 A START ROZRUCH 450 A

20-800 Ah

**YATO**   YT-83060 1

**YATO**   YT-83061 1

**YATO**   YT-83062 1



- GB Jumpstart wires  
 D Starterkabel  
 PL Przewody rozruchowe  
 RUS Пусковые провода  
 CZ Startovací kabely  
 H Indító kábelek
- RO Cabluri demarare  
 F Câbles de démarrage  
 I Cavi carica batteria  
 E Cables de arranque  
 CN 输出线

WINDOW BAG  
WITH ZIPPER



2.5m



| YATO     | rated load / obciążenie nominalne (A) |    |
|----------|---------------------------------------|----|
| YT-83150 | 120                                   | 20 |
| YT-83151 | 200                                   | 12 |

| YATO     | rated load / obciążenie nominalne (A) |    |
|----------|---------------------------------------|----|
| YT-83152 | 400                                   | 12 |

| YATO     | rated load / obciążenie nominalne (A) |    |
|----------|---------------------------------------|----|
| YT-83153 | 600                                   | 12 |

- GB Analogue battery tester  
 D Analoges Batterieprüfgerät  
 PL Tester akumulatorów analogowy  
 RUS Аналоговый тестер аккумуляторов  
 CZ Analogový tester akumulátorů  
 H Analóg akkuteszter  
 RO Tester acumulatori analog  
 F Testeur de charge batterie  
 I Tester analogico per batteria  
 E Tester analógico para acumuladores  
 CN 电池测试器

6V

12V

CCA  
200-  
1000 A

- GB Digital battery tester  
 D Digitales Batterieprüfgerät  
 PL Tester akumulatorów cyfrowy  
 RUS Цифровой тестер аккумуляторов  
 CZ Digitální tester akumulátorů  
 H Digitális akkuteszter  
 RO Tester acumulatori digital  
 F Testeur digital de charge batterie  
 I Tester digitale per batteria  
 E Tester digital para acumuladores  
 CN 电池测试器

12V

LED  
DISPLAY

CCA  
150-  
1400 A

- GB Battery tester  
 D Batterieprüfgerät  
 PL Tester akumulatorów  
 RUS Тестер аккумуляторов  
 CZ Tester akumulátorů  
 H Akkuteszter  
 RO Tester acumulatori  
 F Testeur électronique de charge  
batterie et alternateur  
 I Tester per batteria  
 E Tester para acumuladores  
 CN 电池测试器

12V

BATTERY  
TEST  
TEST  
AKUMULATORA

ALTERNATOR  
TEST  
TEST  
ALTERNATORA



COLOR BOX



| YATO    |    |
|---------|----|
| YT-8310 | 10 |



COLOR BOX



| YATO    |    |
|---------|----|
| YT-8311 | 10 |



DOUBLE BLISTER



| YATO     |       |
|----------|-------|
| YT-83101 | 12/72 |



- GB Chain block  
D Kettenzug Flaschenzug  
PL Wyciągarka łańcuchowa  
RUS Таль цепная  
CZ Zvedák řetězový  
H Lánco csigaszor emelő  
RO Scripete cu lant  
F Treuil à chaîne  
I Paranco a catena  
E Cabría de cadena  
CN 手拉葫芦

COLOR BOX



3m



|             |   |         |             |   |         |
|-------------|---|---------|-------------|---|---------|
| <b>YATO</b> |   |         | <b>YATO</b> |   |         |
| YT-5890     | 1 | 500 kg  | YT-5893     | 1 | 2000 kg |
| <b>YATO</b> |   |         | <b>YATO</b> |   |         |
| YT-5892     | 1 | 1000 kg | YT-5894     | 1 | 3000 kg |

- GB Electric hoist  
D Elektro-Seilwinde  
PL Elektryczny wciągnik linowy  
RUS Электрическая канатная лебёдка  
CZ Elektrický naviják kladkostroj  
H Elektromos csőrőlő  
RO Troliu electric cu cablu  
F Treuil électrique à corde  
I Verricello elettrico  
E Cabría eléctrica de cuerdas  
CN 电动葫芦

COLOR BOX



~230V  
50Hz



|             |   |        |        |             |   |        |        |
|-------------|---|--------|--------|-------------|---|--------|--------|
| <b>YATO</b> |   |        |        | <b>YATO</b> |   |        |        |
| YT-5901     | 2 | 125 kg | 250 kg | YT-5904     | 2 | 250 kg | 500 kg |
| <b>YATO</b> |   |        |        | <b>YATO</b> |   |        |        |
| YT-5902     | 2 | 150 kg | 300 kg | YT-5905     | 2 | 300 kg | 600 kg |

- GB Rope winch  
D Handseilwinde  
PL Wyciągarka linowa  
RUS Канатная лебёдка
- CZ Lanové vyťahovací zařízení  
H Drótköteles csőrőlő  
RO Troliu cu cablu orizontal  
F Treuil à corde
- I Paranco a corda  
E Cabría de cuerdas  
CN 绳索拉紧器

COLOR BOX



1000 daN

|             |      |       |        |   |
|-------------|------|-------|--------|---|
| <b>YATO</b> | daN  | L (m) | Ø (mm) |   |
| YT-5911     | 1000 | 3     | 5      | 6 |



1300 daN

|             |      |       |        |   |
|-------------|------|-------|--------|---|
| <b>YATO</b> | daN  | L (m) | Ø (mm) |   |
| YT-5913     | 1300 | 3     | 5      | 6 |



1500 daN

|             |      |       |        |   |
|-------------|------|-------|--------|---|
| <b>YATO</b> | daN  | L (m) | Ø (mm) |   |
| YT-5914     | 1500 | 3     | 6      | 3 |

GB Shop crane  
 D Werkstattkran  
 PL Żuraw warsztatowy  
 RUS Кран подкатной гидравлический  
 CZ Hydraulický jeřáb

H Motorkiemelő zsráf  
 RO Girafa pt. scos motor  
 F Grue d'atelier  
 I Gru idraulica

E Grúa hidráulica para motores  
 CN 吊机

GREY CARTON BOX  
 & COLOR LABEL

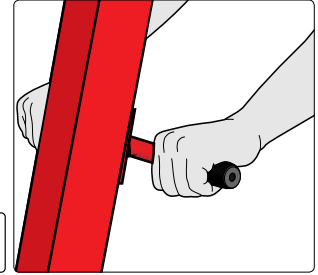

**600**  
kg



**YATO**    
 YT-55560 1

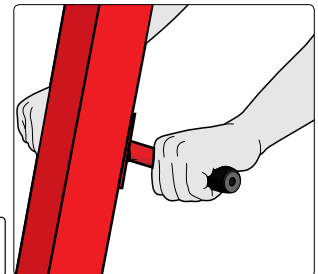

**1000**  
kg



**YATO**    
 YT-55561 1

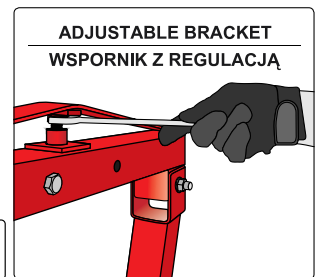

ADJUSTABLE BRACKET  
 WSPORNIK Z REGULACJĄ

**2000**  
kg



**YATO**    
 YT-55562 1



GB Shop press  
D Hydraulische Werkstattpresse  
PL Prasa hydrauliczna  
RUS Гидравлический пресс

CZ Hydraulický lis  
H Hidraulikus prés  
RO Presa hidraulică  
F Presse hydraulique

I Pressa idraulica  
E Prensa de hidráulica  
CN 压力机



**12t**

0-695 mm

400 mm

**20t**

0-695 mm

490 mm

**30t**

0-795 mm

520 mm



**YATO**    
YT-55580 1

**YATO**    
YT-55581 1

**YATO**    
YT-55582 1

GB Crane crossbeam  
D Traverse zum Kran  
PL Trawers do żurawia  
RUS Траверса для крана  
CZ Jefábová traverza  
H Traverz a zsiráf emelőhöz

RO Traversă pt. macara  
F Balancier pour grue d'atelier  
I Traverse per gru  
E Viga transversal para ruas  
CN 平衡器

**680 kg**   
**315 mm** 

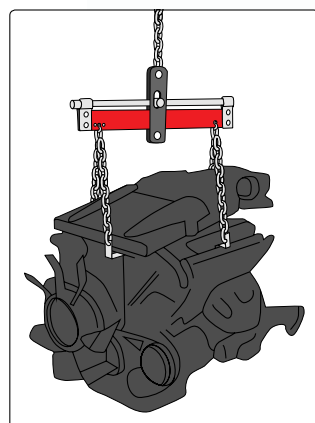

WHITE CARTON BOX  
& COLOR LABEL





**YATO**    
YT-55565 1

GB Engine suspension beam  
D Aufnahmeverrichtung des Motors  
PL Belka do podwieszenia silnika  
RUS Балка для вывешивания двигателя

CZ Nosník k zavěšení motoru  
H Motorfelfüggesztő gerenda  
RO Grindă pt. suspendarea motorului  
F Poutre de suspension de moteur  
I Fascio sospensione del motore

E La viga para suspender el motor  
CN 发动机平衡架

**500kg max.**   
**150 cm** 

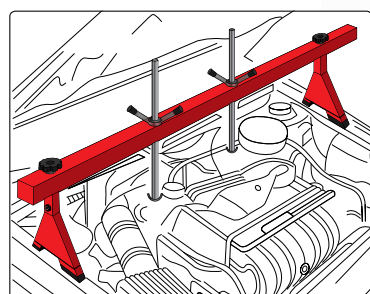

WHITE CARTON BOX  
& COLOR LABEL



**YATO**    
YT-55568 1

GB Grease nipple set  
D Schmiernippel  
PL Zestaw smarowniczek  
RUS Набор масленок

CZ Sady mazacích hlavíc  
H Zsírzórgomb (zsírzófeje) készlet  
RO Set gresoare metalice  
F Set de graisseurs métriques

I Set grasso capezzoli  
E Engrasador  
CN 件套黄油嘴组套

PLASTIC HANGING BOX



110 PCS

METRIC METRYCZNE



|                    |                       |                       |                        |                        |                     |
|--------------------|-----------------------|-----------------------|------------------------|------------------------|---------------------|
| M6X1<br><br>60 pcs | M6X1 45°<br><br>5 pcs | M8X1<br><br>10 pcs    | M8X1 90°<br><br>5 pcs  | M10X1 90°<br><br>5 pcs | M10X1<br><br>10 pcs |
|                    | M6X1 90°<br><br>5 pcs | M8X1 45°<br><br>5 pcs | M10X1 45°<br><br>5 pcs |                        |                     |

**YATO**  
YT-06888 5/20

GB Copper washer set  
D Kupfer-dichtring-sortiment  
PL Zestaw podkładek miedzianych  
RUS Набор медных шайб

CZ Podložky měděné těsnící  
H Réz alátét készlet  
RO Saibe din cupru  
F Patins en cuivre

I Set di spessori  
E Arandelas de cobre  
CN 件套紫铜垫片

PLASTIC HANGING BOX



150 PCS

Cu



|                         |                              |                            |                              |                          |                            |
|-------------------------|------------------------------|----------------------------|------------------------------|--------------------------|----------------------------|
| 5x10x1 mm<br><br>10 pcs | 8x11x1 mm<br><br>10 pcs      | 11x17x1.5 mm<br><br>10 pcs | 12.5x20x1.5 mm<br><br>10 pcs | 15x20x2 mm<br><br>10 pcs | 16.5x24x2 mm<br><br>10 pcs |
| 6x10x1 mm<br><br>10 pcs | 10x16x1 mm<br><br>10 pcs     | 14x18x1 mm<br><br>10 pcs   | 14x20x1.5 mm<br><br>10 pcs   | 16x22x2 mm<br><br>10 pcs | 17.5x24x2 mm<br><br>10 pcs |
| 7x10x1 mm<br><br>10 pcs | 10.5x17x1.5 mm<br><br>10 pcs | 12x20x1.5 mm<br><br>10 pcs |                              |                          |                            |

**YATO**  
YT-06871 20

GB O-ring assortment  
D O-ring Sortiment  
PL Zestaw oringów gumowych  
RUS Набор резиновых прокладок

CZ Gumové „o“ kroužky sada  
H O gyűrű készlet  
RO Garnituri din cauciuc  
F Set d'o-rings en caoutchouc

I Set guarnizioni O-ring  
E Kit de junta tórica  
CN 件套O型圈组套

PLASTIC HANGING BOX



225 PCS

HEAT RESISTANT  
TEMPERATURÓDOPORNÉ

OIL, PETROL, CHEMICAL RESISTANT  
ODPORNE NA OLEJ, BENZYNĘ, CHEMIKALIA



|                      |                        |                        |                      |                      |                        |
|----------------------|------------------------|------------------------|----------------------|----------------------|------------------------|
| 3x1 mm<br><br>20 pcs | 4x1 mm<br><br>20 pcs   | 4.5x2 mm<br><br>20 pcs | 5x2 mm<br><br>20 pcs | 6x2 mm<br><br>20 pcs | 6x2.5 mm<br><br>20 pcs |
| 13x3 mm<br><br>5 pcs | 14x2.5 mm<br><br>5 pcs | 17x2.5 mm<br><br>5 pcs | 18x4 mm<br><br>5 pcs | 20x2 mm<br><br>5 pcs | 22x2 mm<br><br>5 pcs   |
| 6x3 mm<br><br>20 pcs | 7x2 mm<br><br>20 pcs   | 8x2 mm<br><br>20 pcs   | 9x2 mm<br><br>5 pcs  | 10x2 mm<br><br>5 pcs | 12x3 mm<br><br>5 pcs   |

**YATO**  
YT-06877 5/20



GB External circlip assortment  
D Aussen-seegerring-sortiment  
PL Zestaw pierścieni segera zewnętrznych  
RUS Кольца стопорные внешние  
CZ Sada pojistné kroužky  
H Külső seeger-gyűrű készlet

RO Set agrafe  
F Set de circlips ext.  
I Set all'esterno degli anelli Segera  
E Anillos seeger para agujeros exteriores  
CN 件套外挡圈组套



PLASTIC  
HANGING BOX



**300**  
PCS

EXTERNAL  
ZEWNETRZNE



| YATO  | No.  | inner diameter / średnica wewnętrzna (mm) | pcs. / szt. | No.  | inner diameter / średnica wewnętrzna (mm) | pcs. / szt. |  |
|--|------|---|-------------|------|---|-------------|---|
| YT-06880   | R-01 | 3   | 20          | R-11 | 14  | 15          | 5/20  |
|  | R-02 | 4   | 10          | R-12 | 15  | 20          |   |
|  | R-03 | 5   | 15          | R-13 | 19  | 25          |   |
|  | R-04 | 6   | 25          | R-14 | 20  | 15          |   |
|  | R-05 | 8   | 15          | R-15 | 22  | 20          |   |
|  | R-06 | 9   | 20          | R-16 | 25  | 15          |   |
|  | R-07 | 11  | 15          | R-17 | 26  | 15          |   |
|  | R-08 | 12  | 15          | R-18 | 28  | 10          |   |
|  | R-09 | 13  | 25          | R-19 | 32  | 5           |   |

GB Internal circlip assortment  
D Innen-seegerring-sortiment  
PL Zestaw pierścieni segera wewnętrznych  
RUS Кольца стопорные внутренние  
CZ Sada pojistné kroužky  
H Belső seeger-gyűrű készlet

RO Set agrafe  
F Set de circlips int.  
I Set all'interno degli anelli Segera  
E Anillos seeger para agujeros interiores  
CN 件套内挡圈组套



PLASTIC  
HANGING BOX



**300**  
PCS

INTERNAL  
WEWNETRZNE



| YATO  | No.  | inner diameter / średnica wewnętrzna (mm) | pcs. / szt. | No.  | inner diameter / średnica wewnętrzna (mm) | pcs. / szt. |  |
|--|------|---|-------------|------|---|-------------|---|
| YT-06881   | R-01 | 3   | 20          | R-11 | 14  | 15          | 5/20  |
|  | R-02 | 4   | 10          | R-12 | 15  | 20          |   |
|  | R-03 | 5   | 15          | R-13 | 19  | 25          |   |
|  | R-04 | 6   | 25          | R-14 | 20  | 15          |   |
|  | R-05 | 8   | 15          | R-15 | 22  | 20          |   |
|  | R-06 | 9   | 20          | R-16 | 25  | 15          |   |
|  | R-07 | 11  | 15          | R-17 | 26  | 15          |   |
|  | R-08 | 12  | 15          | R-18 | 28  | 10          |   |
|  | R-09 | 13  | 25          | R-19 | 32  | 5           |   |

# 17

## Welding equipment & accessories Narzędzia spawalnicze i akcesoria





**Welding helmets**  
Przyłbice spawalnicze



380

**Profile connection & forming pliers**  
Szcypce do łączenia i kształtowania profili



384

**Ball peen hammers & sets**  
Młotki blacharskie i zestawy



381

**Magnetic holders**  
Wsporniki magnetyczne



385

**Dead blow hammers**  
Młotki bezodrzutowe



382

**Tin snips**  
Nożyce do blachy



386-389

**Lock grip pliers**  
Szcypce zaciskowe



383-384

**Self-locking multi grip pliers**  
Szcypce blacharskie..... 383

**Welding locking pliers**  
Szcypce zaciskowe, spawalnicze..... 383

**Flat locking pliers**  
Szcypce zaciskowe o szerokich szczękach..... 383

**C-type welding locking pliers**  
Szcypce zaciskowe, klamrowe typu „C”..... 384

**Chain locking pliers**  
Szcypce zaciskowe z łańcuchem..... 384

GB Auto-darkening welding helmet  
 D Schweißmaske, selbstverdunkelnd  
 PL Przyłbica spawalnicza samościemniająca  
 RUS Маска для сварки, самостоятельно затемняющаяся  
 CZ Svářečská kukla samostmívací

H Önmagától sötétedő hegesztőpajzs  
 RO Mască de sudură auto-întunecare  
 F Masque de soudage  
 I Oscuramento casco di saldatura  
 E Casco auto-oscurecedor para soldadura  
 CN 工具车双挂板

COLOR BOX

|   |  |   |   |
|---|--|---|---|
| <b>DARK STATE</b><br>STAN CIEMNY<br><b>9-13</b> | <b>LIGHT STATE</b><br>STAN JASNY<br><b>4</b>         | <b>REACTION TIME</b><br>CZAS REAKCJI<br>1/25000 s                     | <b>BRIGHTENING TIME</b><br>CZAS ROZJAŚNIANIA<br>0.1-1.0 s       |
| <b>FILTER TEST</b><br>TEST FILTRA               | <b>LOW BATTERY ALARM</b><br>WSKAZNIK POZIOMY BATERII | <b>2x3V CR2045</b><br>BATTERIES NOT INCLUDED<br>BATERIE NIE DOŁĄCZONE | <b>WORKING TEMPERATURE</b><br>TEMPERATURA PRACY<br>-5°C ÷ +55°C |

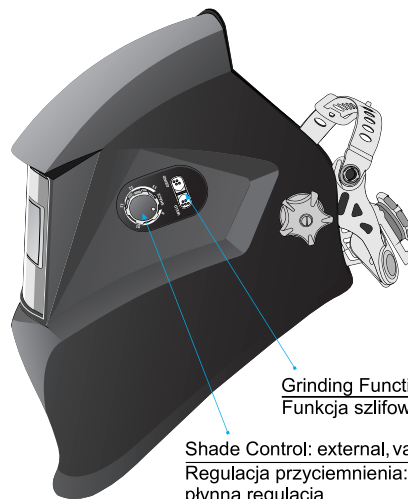

**Grinding Function: YES**  
 Funkcja szlifowania: TAK

**Shade Control: external, variable**  
 Regulacja przyciemnienia: zewnętrzna, płynna regulacja

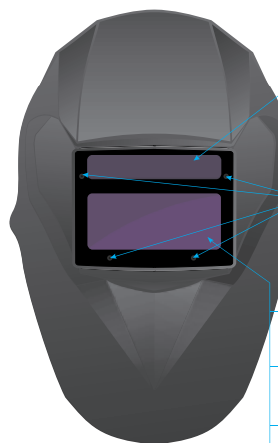

**Solar cell filter power supply during welding**  
 Ogniwo słoneczne zasilanie filtra podczas spawania

**Arc Sensor: 4**  
 Liczba czujników łuku: 4

**Viewing Area: 98x43mm**  
 Obszar pola widzenia: 98x43 mm

**UV/IR Protection**  
 Ochrona przed promieniowaniem UV/IR

**Automatic power on / off**  
 Automatyczne włączenie / wyłączenie

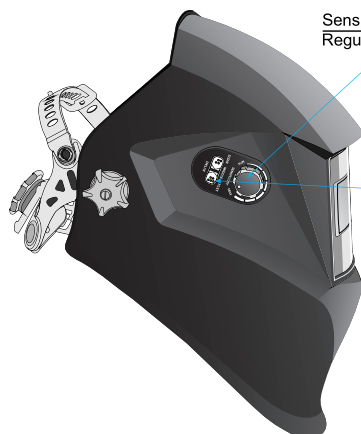

**Sensitivity Control**  
 Regulacja czułości

**The rate of dimming**  
 Szybkość ściemniania  
 0.3 - 1.0 ms

17

**4 POINT HEADGEAR**  
**WIĘŻBA 4 PUNKTOWA**

2-point crown strap adjustment to rise or lower the helmet  
 2 punktowa regulacja wysokości

Lock into a detent when lifted  
 Blokada w pozycji podniesionej

3 position slider to adjust the distance from eyes to lens  
 3 pozycje regulacji odległości od filtra

Regulation at the occipital area  
 Regulacja pozycji potylicznej

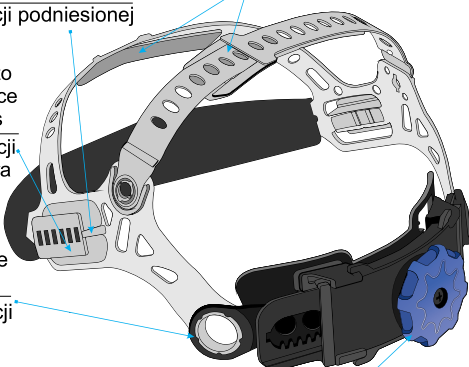

Ratchet with soft rubber grip to adjust size without removing the helmet  
 Regulacji obwodu za pomocą systemu grzechotkowego

- EN 379
- optical properties: 1 / 2 / 1 / 3
- właściwości optyczne: 1 / 2 / 1 / 3



- GB Auto body fender set  
D Karosserie-Ausbeulsatz  
PL Komplet młotków blacharskich  
RUS Молотки рихтовочные  
CZ Souprava klempířských kladívek  
H Bádogos kalapács készlet
- RO Set de ciocane de tablă  
F Set pour carrossier  
I Martello per lamiera  
E Juego de mazos de hojalatero  
CN 钣金工具组套

7  
PCS



DROP  
FORGED  
KUTE

GENUINE  
HICKORY





BMC  
& COLOR  
SLEEVE



| YATO  | m (g) |  |
|--|-------|---|
| YT-4590  | 4900  | 4   |

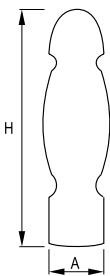

- GB Ball pein hammer  
D Ausbeulhammer  
PL Młotek blacharski  
RUS Молоток рихтовочный  
CZ Klempířské kladívko  
H Bádogos kalapács
- RO Ciocan pt. tabla  
F Marteau à panne ronde  
I Martello per lamiera  
E Martillo de hojalatero  
CN 圆头锤

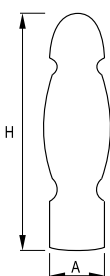

| YATO  | m (g) | L (mm) | A (mm) | H (mm) |  |
|--|-------|--------|--------|--------|---|
| YT-4515  | 225   | 280    | 26     | 80     | 6/36  |
| YT-4516  | 450   | 315    | 34     | 100    | 6/24  |
| YT-4518  | 900   | 380    | 40     | 125    | 6/12  |

- GB Ball pein hammer  
D Ausbeulhammer  
PL Młotek blacharski  
RUS Молоток рихтовочный  
CZ Klempířské kladívko  
H Bádogos kalapács
- RO Ciocan pt. tabla  
F Marteau à panne ronde  
I Martello per lamiera  
E Martillo de hojalatero  
CN 圆头锤



| YATO  | m (g) | L (mm) | A (mm) | H (mm) |  |
|--|-------|--------|--------|--------|---|
| YT-4519  | 225   | 295    | 26     | 80     | 6/36  |
| YT-4520  | 450   | 335    | 35     | 100    | 6/24  |
| YT-4521  | 680   | 360    | 36     | 115    | 6/12  |
| YT-4522  | 900   | 380    | 40     | 125    | 6/12  |

- GB Dead blow mallet
- D Rückschlagsfreier Schonhammer
- PL Młotek bezodrzutowy
- RUS Молоток безинерционный
- CZ Palička nárazová plněná celogumová
- H Visszarúgás mentes gumikalapács
- RO Ciocan cu absorbție
- F Maillet sans recul
- I Martello morto colpo
- E Martillo sin reacción
- CN 防震无回弹橡胶锤

**PU**



| YATO    | m (g) | L (mm) | Ø (mm) | H (mm) |       |
|---------|-------|--------|--------|--------|-------|
| YT-4624 | 265   | 318    | 30.0   | 94     | 10/40 |
| YT-4625 | 430   | 350    | 40.0   | 100    | 6/36  |
| YT-4626 | 490   | 348    | 45.0   | 110    | 6/36  |

- GB Dead blow mallet
- D Rückschlagsfreier Schonhammer
- PL Młotek bezodrzutowy
- RUS Молоток безинерционный
- CZ Palička nárazová plněná celogumová
- H Visszarúgás mentes gumikalapács
- RO Ciocan cu absorbție
- F Maillet sans recul
- I Martello morto colpo
- E Martillo sin reacción
- CN 防震无回弹橡胶锤

**PU**

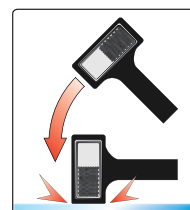

| YATO    | m (g) | L (mm) | Ø (mm) | H (mm) |      |
|---------|-------|--------|--------|--------|------|
| YT-4620 | 740   | 300    | 44.5   | 100.0  | 4/24 |
| YT-4622 | 900   | 336    | 53.5   | 100.0  | 4/24 |
| YT-4623 | 1300  | 350    | 59.0   | 118.5  | 3/12 |

- GB PU & nylon heads mallet
- D Schonhammer mit PU & Nylon-Schlagkopf
- PL Młotek blacharski
- RUS Молоток рихтовочный
- CZ Palička klempířská
- H Vaskalapács
- RO Ciocan tinichigerie cap PU / nylon
- F Marteau spécial en PU/nylon
- I Martello per lamiera
- E Martillo chapista
- CN 木柄安装锤

**PU** **NYLON**



| YATO    | m (g) | L (mm) | Ø (mm) | H (mm) |      |
|---------|-------|--------|--------|--------|------|
| YT-4630 | 150   | 250    | 22     | 75     | 6/48 |
| YT-4631 | 250   | 280    | 28     | 85     | 6/36 |
| YT-4632 | 340   | 315    | 35     | 95     | 6/36 |
| YT-4633 | 660   | 350    | 45     | 105    | 6/24 |
| YT-4634 | 1340  | 380    | 60     | 132    | 4/16 |

17

- GB PU head for mallet
- D Polyurethan Schlagkopf
- PL Końcówka PU do młotka
- RUS Наконечник молотка из полиуретана
- CZ Náhradní koncovka k paličce PU
- H PU kalapácsfej cserélhető
- RO Cap PU pt. ciocan tinichigerie
- F Tête PU pour marteau
- I Bocca PU di ricambio
- E Cabeza PU para martillo chapista
- CN PU软头

**PU**

**SOFT**  
**MIĘKKA**



| YATO    | Ø (mm) | for / dla |      |
|---------|--------|-----------|------|
| YT-4635 | 22     | YT-4630   | 6/60 |
| YT-4636 | 28     | YT-4631   | 6/60 |
| YT-4637 | 35     | YT-4632   | 6/60 |
| YT-4638 | 45     | YT-4633   | 6/60 |
| YT-4639 | 60     | YT-4634   | 6/60 |

- GB Nylon head for mallet
- D Nylon Schlagkopf
- PL Końcówka nylonowa do młotka
- RUS Наконечник молотка из твердого нейлона
- CZ Náhradní koncovka k paličce nylon
- H Műanyag kalapácsfej cserélhető
- RO Cap nylon pt. ciocan tinichigerie
- F Tête nylon pour marteau
- I Bocca di ricambio, nylon
- E Cabeza de nylon para martillo chapista
- CN 尼龙硬头

**NYLON**

**HARD**  
**TWARDA**





| YATO    | Ø (mm) | for / dla |      |
|---------|--------|-----------|------|
| YT-4640 | 22     | YT-4630   | 6/60 |
| YT-4641 | 28     | YT-4631   | 6/60 |
| YT-4642 | 35     | YT-4632   | 6/60 |
| YT-4643 | 45     | YT-4633   | 6/60 |
| YT-4644 | 60     | YT-4634   | 6/60 |

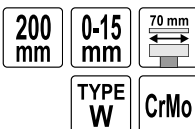

- GB Self-locking multi grip pliers  
D Grip-Festhaltezange  
PL Szczypce blacharskie  
RUS Зажим ручной сварочный для закрепления лент и профилей  
CZ Kleště klempířské samodržící  
H Őnzáró rögzítőfogó  
RO Cleste autoblocant pt. tinichigerie  
F Pince pour tôle  
I Pinze per lamiera  
E Pinzas de chapa  
CN 多功能大力钳

SLIDING CARD





| YATO  | L (mm) |  |
|--|--------|---|
| YT-2160  | 200    | 12/24   |

- GB Self-locking multi grip pliers  
D Grip-Festhaltezange  
PL Szczypce blacharskie  
RUS Зажим ручной сварочный для закрепления лент и профилей  
CZ Kleště klempířské samodržící  
H Őnzáró rögzítőfogó  
RO Cleste autoblocant pt. tinichigerie  
F Pince pour tôle  
I Pinze per lamiera  
E Pinzas de chapa  
CN 多功能大力钳

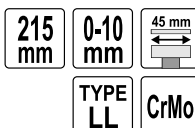
SLIDING CARD





| YATO  | L (mm) |  |
|--|--------|---|
| YT-2162  | 215    | 12/36   |

- GB Welding locking pliers  
D Klemmzange zum Schweißen  
PL Szczypce zaciskowe spawalnicze  
RUS Клещи давяльные сварочные  
CZ Kleště samosvorné svářečské  
H Hegesztő fogó  
RO Clește de strângere pt. sudură  
F Pincés de serrage pour soudeur  
I Pinze di bloccaggio per saldatura  
E Pinzas de tornillo (de apriete) para soldar  
CN 焊接用大力钳

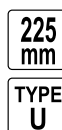
HALF DOUBLE BLISTER





| YATO  | L (mm) |  |
|--|--------|---|
| YT-2461  | 225    | 6/24  |

- GB Self-locking multi grip pliers  
D Grip-Festhaltezange  
PL Szczypce blacharskie  
RUS Зажим ручной сварочный для закрепления лент и профилей  
CZ Kleště klempířské samodržící  
H Őnzáró rögzítőfogó  
RO Cleste autoblocant pt. tinichigerie  
F Pince pour tôle  
I Pinze per lamiera  
E Pinzas de chapa  
CN 多功能大力钳

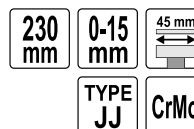
SLIDING CARD





| YATO  | L (mm) |  |
|--|--------|---|
| YT-2161  | 230    | 12/24   |

- GB Self-locking multi grip pliers  
D Grip-Festhaltezange  
PL Szczypce blacharskie  
RUS Зажим ручной сварочный для закрепления лент и профилей  
CZ Kleště klempířské samodržící  
H Őnzáró rögzítőfogó  
RO Cleste autoblocant pt. tinichigerie  
F Pince pour tôle  
I Pinze per lamiera  
E Pinzas de chapa  
CN 多功能大力钳

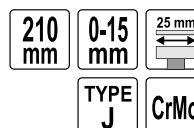
SLIDING CARD





| YATO  | L (mm) |  |
|--|--------|---|
| YT-2163  | 210    | 12/36   |

- GB Flat locking pliers  
D Klemmzange mit breiten Backen  
PL Szczypce zaciskowe o szerokich szczękach  
RUS Клещи давяльные с широкими губками  
CZ Kleště samosvorné se širokými čelistmi  
H Lapos fogó  
RO Clește de strângere plat / patent  
F Pincés de serrage large  
I Pinze con ganasce piane e paletta  
E Pinzas de tornillo (de apriete) con mordazas anchas  
CN 铁皮大力钳

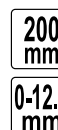
HALF DOUBLE BLISTER



| YATO  | L (mm) |  |
|--|--------|---|
| YT-2463  | 200    | 6/24  |

GB C-type welding locking pliers  
 D Klemm- und Klammerzange vom Typ „C“  
 PL Szczypce zaciskowe klamrowe typu „C“  
 RUS Клеши давяльные типа „С“  
 CZ Kleště samosvorné upínací typu „C“  
 H „C“ fogó

RO Clește de strângere cu clemă tip „C“  
 F Pince de serrage type „C“  
 I Pinze di bloccaggio tipo „C“  
 E Pinzas de tornillo (de apriete) de grapa tipo „C“  
 CN C型大力钳

HALF  
DOUBLE  
BLISTER



**280 mm**  
**0-100 mm**  
**TYPE C**



|             |        |      |
|-------------|--------|------|
| <b>YATO</b> | L (mm) |      |
| YT-2466     | 280    | 6/24 |

|             |        |      |
|-------------|--------|------|
| <b>YATO</b> | L (mm) |      |
| YT-2468     | 280    | 6/24 |

GB Chain locking pliers  
 D Klemmzange mit Kette  
 PL Szczypce zaciskowe z łańcuchem  
 RUS Клеши давяльные с цепью  
 CZ Kleště samosvorné s řetězem  
 H Láncos csőfogó  
 RO Clește de strângere cu lanț  
 F Pince de serrage avec une chaîne  
 I Pinze di bloccaggio con la catena  
 E Pinzas de tornillo (de apriete) con cadena  
 CN 链条大力钳



HALF  
DOUBLE  
BLISTER



**500 mm**  
**40 Mn**

|             |      |
|-------------|------|
| <b>YATO</b> |      |
| YT-2469     | 6/24 |

GB Profile connection pliers  
 D Zange zum Verbinden der Profile  
 PL Szczypce do łączenia profili  
 RUS Щипцы для соединения профилей  
 CZ Kleště ke spojování profilů  
 H Profilegyesítő fogó  
 RO Cleste pt. îmbinarea profilelor  
 F Pince pour sertir les profiles  
 I Pinze per la unione profili  
 E Pinzas para conectar perfiles  
 CN 龙骨钳

SLIDING  
CARD



SECTION  
THICKNESS  
GRUBOSC  
PROFILU  
0,6-0,8 mm



**275 mm**  
**A380**  
**Al-Ti**  
 BEARING  
 ALLOY  
 (HEAD)  
**GR15**  
 BEARING  
 STEEL  
 (PUNCH)

|             |        |      |
|-------------|--------|------|
| <b>YATO</b> | L (mm) |      |
| YT-5130     | 275    | 6/24 |



**345 mm**  
**65 Mn**  
 MATERIAL  
 OF PUNCH  
 PUNKTAK

|             |        |      |
|-------------|--------|------|
| <b>YATO</b> | L (mm) |      |
| YT-5131     | 345    | 6/24 |

GB Profile forming pliers  
 D Zange zur Formgebung der Profile  
 PL Szczypce do kształtowania profili  
 RUS Щипцы для формовки профилей  
 CZ Kleště k tvarování profilů  
 H Profilformázó fogó  
 RO Cleste pt. modelarea profilelor  
 F Pince pour former les profiles  
 I Pinze per la formazione di profili  
 E Pinzas para formar perfiles  
 CN 龙骨钳

SLIDING  
CARD



**210 mm**

80x35 mm  
 JAWS  
 SZCZĘKI

|             |        |      |
|-------------|--------|------|
| <b>YATO</b> | L (mm) |      |
| YT-5140     | 210    | 2/12 |

80x35 mm  
 JAWS  
 SZCZĘKI

|             |        |      |
|-------------|--------|------|
| <b>YATO</b> | L (mm) |      |
| YT-5141     | 210    | 2/12 |

150x35 mm  
 JAWS  
 SZCZĘKI

|             |        |      |
|-------------|--------|------|
| <b>YATO</b> | L (mm) |      |
| YT-5142     | 210    | 2/12 |





- GB Adjustable angle welding magnet  
D Verstellbarer Magnet-Werkstückhalter  
PL Wspornik magnetyczny spawalniczy regulowany  
RUS Регулируемый магнит заварки угла  
CZ Polohovací magnetický držák ke svařování  
H Állítható, mágneses, hegesztő támasz  
RO Dispozitiv magnetic reglabil pt. sudura  
F Support magnétique de soudure  
I Supporto della saldatura magnetico  
E Soporte magnético de soldadura, ajustable  
CN 焊接磁铁



DOUBLE  
BLISTER



| YATO  |  (kg) | mm       |  |
|--|---|----------|---|
| YT-0862  | 2x22.5  | 85x65x22 | 6   |



- GB Magnetic welding holder  
D Magnet-Werkstückhalter  
PL Kątownik magnetyczny spawalniczy  
RUS Магнитная струбцина заварки

- CZ Magnetický uhelník ke svařování  
H Mágneses, hegesztő szögvas  
RO Dispozitiv magnetic fixare pt. sudura  
F Support magnétique de soudure



- I Angolo magnetico da saldatura  
E Escuadra magnética de soldadura  
CN 焊接磁铁

DOUBLE  
BLISTER



| YATO  |  (kg) | mm        |  |
|---|---|-----------|--|
| YT-0863   | 11.5  | 82x120x13 | 6/48   |



| YATO  |  (kg) | ∅ (mm) | mm         |  |
|---|---|--------|------------|--|
| YT-0864   | 22.5  | 18     | 102x155x17 | 6/30   |
| YT-0865   | 34.0  | 46     | 122x190x25 | 6/18   |



- GB Magnetic welding holder  
D Magnet-Werkstückhalter  
PL Kątownik magnetyczny spawalniczy z wyłącznikiem  
RUS Магнитная струбцина заварки

- CZ Magnetický uhelník ke svařování s vypínačem  
H Mágneses, hegesztő szögvas, kapcsolóval  
RO Dispozitiv magnetic fixare pt. sudura cu intreruptor  
F Support magnétique de soudure

- I Triangolo magnetico da saldatura con interruttore  
E Escuadra magnética de soldadura, con interruptor  
CN 焊接磁铁

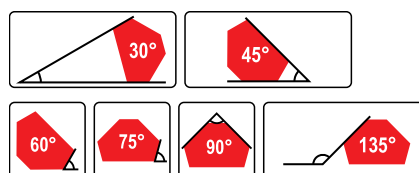
DOUBLE  
BLISTER



| YATO  |  (kg) | mm         |  |
|--|---|------------|---|
| YT-0866  | 11.5  | 64x95x14   | 6/24  |
| YT-0867  | 34.0  | 111x136x24 | 6/18  |



- GB Magnetic welding holder with switch  
D Magnet-Werkstückhalter mit Schalter  
PL Kątownik magnetyczny spawalniczy z wyłącznikiem  
RUS Магнитный держатель заварки с выключателем

- CZ Magnetický uhelník ke svařování s vypínačem  
H Mágneses, hegesztő szögvas, kapcsolóval  
RO Dispozitiv magnetic fixare pt. sudura cu intreruptor  
F Support magnétique de soudure

- I Triangolo magnetico da saldatura con interruttore  
E Escuadra magnética de soldadura, con interruptor  
CN 焊接磁铁

DOUBLE  
BLISTER



| YATO  |  (kg) | mm         |  |
|--|---|------------|---|
| YT-0870  | 13.5  | 107x160x26 | 6/24  |

GB Tin snips  
D Blechscherer  
PL Nożyce do cięcia blachy

RUS Ножницы по металлу  
CZ Nůžky na plech  
H Lemezvágó olló

RO Foarfece pt. tablă  
F Cisaille à tôle  
I Cesioie per lamiere

E Tijeras para chapas  
CN 铁皮剪

SLIDING  
CARD



LEFT  
CUT  
CIECIE  
LEWE

CrMo

INCREASED  
CUTTING  
POWER  
ZWIĘKSZONA  
SIŁA CIĘCIA

HRC  
60-62

DIN  
6438



HRC  
60-62

DIN  
6438



| YATO    | L (mm) | cutting length (mm) | cutting capacities (mm) |                   |                  |                     | 6/36 |
|---------|--------|---------------------|-------------------------|-------------------|------------------|---------------------|------|
|         |        |                     | copper                  | cold-rolled steel | hard steel HRC35 | stainless steel 304 |      |
| YT-1910 | 260    | 35                  | 1.80                    | 1.50              | 1.00             | 0.90                | 6/36 |

| YATO    | L (mm) | cutting length (mm) | cutting capacities (mm) |                   |                  |                     | 6/36 |
|---------|--------|---------------------|-------------------------|-------------------|------------------|---------------------|------|
|         |        |                     | copper                  | cold-rolled steel | hard steel HRC35 | stainless steel 304 |      |
| YT-1915 | 235    | 30                  | 1.50                    | 1.20              | 1.00             | 0.70                | 6/36 |

HRC  
60-62

DIN  
6438



HRC  
56-62

SERRATED  
EDGES  
ZABKOWANA  
KRAWĘDZ  
OSTRY

HIGH  
FREQUENCY  
HARDENING  
HARTOWANIE  
IMPULSOWE



| YATO    | L (mm) | cutting length (mm) | cutting capacities (mm) |                   |                  |                     | 6/36 |
|---------|--------|---------------------|-------------------------|-------------------|------------------|---------------------|------|
|         |        |                     | copper                  | cold-rolled steel | hard steel HRC35 | stainless steel 304 |      |
| YT-1918 | 260    | 32                  | 1.80                    | 1.50              | 1.00             | 0.90                | 6/36 |

| YATO    | L (mm) | cutting length (mm) | cutting capacities (mm) |                   |                  |                     | 6/36 |
|---------|--------|---------------------|-------------------------|-------------------|------------------|---------------------|------|
|         |        |                     | copper                  | cold-rolled steel | hard steel HRC35 | stainless steel 304 |      |
| YT-1960 | 250    | 40                  | 2.00                    | 1.50              | 1.00             | 0.80                | 6/36 |

GB Tin snips  
D Blechscherer  
PL Nożyce do cięcia blachy  
RUS Ножницы по металлу  
CZ Nůžky na plech  
H Lemezvágó olló  
RO Foarfece pt. tablă  
F Cisaille à tôle  
I Cesioie per lamiere  
E Tijeras para chapas  
CN 铁皮剪



LEFT  
CUT  
CIECIE  
LEWE

HRC  
60-62

90°

CrMo

SERRATED  
EDGES  
ZABKOWANA  
KRAWĘDZ  
OSTRY



SLIDING  
CARD



| YATO    | L (mm) | cutting length (mm) | cutting capacities (mm) |                   |                  |                     | 6/36 |
|---------|--------|---------------------|-------------------------|-------------------|------------------|---------------------|------|
|         |        |                     | copper                  | cold-rolled steel | hard steel HRC35 | stainless steel 304 |      |
| YT-1913 | 225    | 30                  | 0.78                    | 0.53              | 0.46             | 0.36                | 6/36 |

GB Tin snips  
D Blechscherer  
PL Nożyce do cięcia blachy

RUS Ножницы по металлу  
CZ Nůžky na plech  
H Lemezvágó olló

RO Foarfece pt. tablă  
F Cisaille à tôle  
I Cesioie per lamiere

E Tijeras para chapas  
CN 铁皮剪

SLIDING  
CARD



STRAIGHT  
CUT  
CIECIE  
PROSTE

CrMo

INCREASED  
CUTTING  
POWER  
ZWIĘKSZONA  
SIŁA CIĘCIA

HRC  
60-62

DIN  
6438



HRC  
60-62

DIN  
6438



HRC  
60-62

DIN  
6438



HRC  
56-62

SERRATED  
EDGES  
ZABKOWANA  
KRAWĘDZ  
OSTRY

HIGH  
FREQUENCY  
HARDENING  
HARTOWANIE  
IMPULSOWE



| YATO    | L (mm) | cutting length (mm) | cutting capacities (mm) |                   |                  |                     | 6/36 |
|---------|--------|---------------------|-------------------------|-------------------|------------------|---------------------|------|
|         |        |                     | copper                  | cold-rolled steel | hard steel HRC35 | stainless steel 304 |      |
| YT-1923 | 230    | 25                  | 2.00                    | 1.60              | 1.20             | 1.20                | 6/36 |

| YATO    | L (mm) | cutting length (mm) | cutting capacities (mm) |                   |                  |                     | 6/36 |
|---------|--------|---------------------|-------------------------|-------------------|------------------|---------------------|------|
|         |        |                     | copper                  | cold-rolled steel | hard steel HRC35 | stainless steel 304 |      |
| YT-1962 | 250    | 45                  | 2.00                    | 1.50              | 1.00             | 0.80                | 6/36 |



GB Tin snips  
D Blechscherer  
PL Nożyce do cięcia blachy

RUS Ножницы по металлу  
CZ Nůžky na plech  
H Lemezvágó olló

RO Foarfece pt. tablă  
F Cisaille à tôle  
I Cesioie per lamiere

E Tijeras para chapas  
CN 铁皮剪

SLIDING CARD



RIGHT CUT  
CIECIE PRAWIE

CrMo

INCREASED CUTTING POWER  
ZWIĘKSZONA SIŁA CIĘCIA

HRC 60-62

DIN 6438



HRC 60-62

DIN 6438



| YATO    | L (mm) | cutting length (mm) | cutting capacities (mm) |                   |                  |                     | 6/36 |
|---------|--------|---------------------|-------------------------|-------------------|------------------|---------------------|------|
|         |        |                     | copper                  | cold-rolled steel | hard steel HRC35 | stainless steel 304 |      |
| YT-1911 | 260    | 35                  | 1.80                    | 1.50              | 1.00             | 0.90                | 6/36 |

| YATO    | L (mm) | cutting length (mm) | cutting capacities (mm) |                   |                  |                     | 6/36 |
|---------|--------|---------------------|-------------------------|-------------------|------------------|---------------------|------|
|         |        |                     | copper                  | cold-rolled steel | hard steel HRC35 | stainless steel 304 |      |
| YT-1916 | 235    | 30                  | 1.50                    | 1.20              | 1.00             | 0.70                | 6/36 |

HRC 60-62

DIN 6438



HRC 56-62

SERRATED EDGES  
ZĄBKOWANA KRAWĘDZ OSTRZY

HIGH FREQUENCY HARDENING  
HARTOWANIE IMPULSOWE



| YATO    | L (mm) | cutting length (mm) | cutting capacities (mm) |                   |                  |                     | 6/36 |
|---------|--------|---------------------|-------------------------|-------------------|------------------|---------------------|------|
|         |        |                     | copper                  | cold-rolled steel | hard steel HRC35 | stainless steel 304 |      |
| YT-1919 | 260    | 32                  | 1.80                    | 1.50              | 1.00             | 0.90                | 6/36 |

| YATO    | L (mm) | cutting length (mm) | cutting capacities (mm) |                   |                  |                     | 6/36 |
|---------|--------|---------------------|-------------------------|-------------------|------------------|---------------------|------|
|         |        |                     | copper                  | cold-rolled steel | hard steel HRC35 | stainless steel 304 |      |
| YT-1961 | 250    | 40                  | 2.00                    | 1.50              | 1.00             | 0.80                | 6/36 |

GB Tin snips  
D Blechscherer  
PL Nożyce do cięcia blachy  
RUS Ножницы по металлу  
CZ Nůžky na plech  
H Lemezvágó olló  
RO Foarfece pt. tablă  
F Cisaille à tôle  
I Cesioie per lamiere  
E Tijeras para chapas  
CN 铁皮剪



RIGHT CUT  
CIECIE PRAWIE

HRC 60-62

CrMo

90°

SERRATED EDGES  
ZĄBKOWANA KRAWĘDZ OSTRZY

SLIDING CARD



| YATO    | L (mm) | cutting length (mm) | cutting capacities (mm) |                   |                  |                     | 6/36 |
|---------|--------|---------------------|-------------------------|-------------------|------------------|---------------------|------|
|         |        |                     | copper                  | cold-rolled steel | hard steel HRC35 | stainless steel 304 |      |
| YT-1914 | 225    | 30                  | 0.78                    | 0.53              | 0.46             | 0.36                | 6/36 |

GB Tin snips  
D Blechscherer  
PL Nożyce do cięcia blachy  
RUS Ножницы по металлу  
CZ Nůžky na plech  
H Lemezvágó olló  
RO Foarfece pt. tablă  
F Cisaille à tôle  
I Cesioie per lamiere  
E Tijeras para chapas  
CN 铁皮剪



LEFT CUT  
CIECIE LEWIE

DROP FORGED  
KUTE

HRC 58-61

SLIDING CARD



| YATO    | L (mm) | cutting length (mm) | cutting capacities (mm) |                   |                  |                     | 6/24 |
|---------|--------|---------------------|-------------------------|-------------------|------------------|---------------------|------|
|         |        |                     | copper                  | cold-rolled steel | hard steel HRC35 | stainless steel 304 |      |
| YT-1900 | 260    | 30                  | 0.94                    | 0.78              | 0.60             | 0.45                | 6/24 |

GB Tin snips  
D Blechscherer  
PL Nożyce do cięcia blachy  
RUS Ножницы по металлу  
CZ Nůžky na plech  
H Lemezvágó olló

RO Foarfece pt. tablă  
F Cisaille à tôle  
I Cesioie per lamiere  
E Tijeras para chapas  
CN 铁皮剪

SLIDING CARD



RIGHT CUT  
CIECIE PRAWIE

DROP FORGED  
KUTE

HRC 58-61



| YATO    | L (mm) | cutting length (mm) | cutting capacities (mm) |                   |                  |                     | 6/24 |
|---------|--------|---------------------|-------------------------|-------------------|------------------|---------------------|------|
|         |        |                     | copper                  | cold-rolled steel | hard steel HRC35 | stainless steel 304 |      |
| YT-1901 | 260    | 30                  | 0.94                    | 0.78              | 0.60             | 0.45                | 6/24 |

| YATO    | L (mm) | cutting length (mm) | cutting capacities (mm) |                   |                  |                     | 6/24 |
|---------|--------|---------------------|-------------------------|-------------------|------------------|---------------------|------|
|         |        |                     | copper                  | cold-rolled steel | hard steel HRC35 | stainless steel 304 |      |
| YT-1902 | 300    | 50                  | 0.94                    | 0.78              | 0.60             | 0.45                | 6/24 |

GB Tin snips  
D Blechscherer  
PL Nożyce do cięcia blachy  
RUS Ножницы по металлу

CZ Nůžky na plech  
H Lemezvágo olló  
RO Foarfece pt. tablă  
F Cisaille à tôle

I Cesioie per lamiere  
E Tijeras para chapas  
CN 铁皮剪

SLIDING CARD



For cutting straight and tight curves left or right



HRC 58-61

| YATO    | L (mm) | cutting length (mm) | cutting capacities (mm) |                   |                  |                     | 6/36 |
|---------|--------|---------------------|-------------------------|-------------------|------------------|---------------------|------|
|         |        |                     | copper                  | cold-rolled steel | hard steel HRC35 | stainless steel 304 |      |
| YT-1924 | 254    | 52                  | 0.94                    | 0.78              | 0.60             | 0.45                | 6/36 |



STRAIGHT CUT  
CIĘCIE PROSTE  
HRC 58-61  
DROP FORGED  
KUTE

| YATO    | L (mm) | cutting length (mm) | cutting capacities (mm) |                   |                  |                     | 6/36 |
|---------|--------|---------------------|-------------------------|-------------------|------------------|---------------------|------|
|         |        |                     | copper                  | cold-rolled steel | hard steel HRC35 | stainless steel 304 |      |
| YT-1925 | 225    | 52                  | 0.94                    | 0.78              | 0.60             | 0.45                | 6/36 |



HRC 58-60

| YATO    | L (mm) | cutting length (mm) | cutting capacities (mm) |                   |                  |                     | 6/36 |
|---------|--------|---------------------|-------------------------|-------------------|------------------|---------------------|------|
|         |        |                     | copper                  | cold-rolled steel | hard steel HRC35 | stainless steel 304 |      |
| YT-1920 | 260    | 42                  | 1.20                    | 1.00              | 0.60             | 0.50                | 6/36 |

GB Tin snips  
D Blechscherer  
PL Nożyce do cięcia blachy  
RUS Ножницы по металлу  
CZ Nůžky na plech  
H Lemezvágo olló  
RO Foarfece pt. tablă  
F Cisaille à tôle  
I Cesioie per lamiere  
E Tijeras para chapas  
CN 铁皮剪

SLIDING CARD



S55C  
DROP FORGED STEEL  
STAL KUTA NA ZIMNO  
HRC 55-60  
HIGH FREQUENCY HARDENING  
HARTOWANIE IMPULSOWE

GB Tin snips  
D Blechscherer  
PL Nożyce do cięcia blachy  
RUS Ножницы по металлу  
CZ Nůžky na plech  
H Lemezvágo olló  
RO Foarfece pt. tablă  
F Cisaille à tôle  
I Cesioie per lamiere  
E Tijeras para chapas  
CN 铁皮剪

SLIDING CARD



S55C  
DROP FORGED STEEL  
STAL KUTA NA ZIMNO  
HRC 55-60  
HIGH FREQUENCY HARDENING  
HARTOWANIE IMPULSOWE



| YATO    | L (mm) | cutting length (mm) | cutting capacities (mm) |                   |                  |                     | 6/36 |
|---------|--------|---------------------|-------------------------|-------------------|------------------|---------------------|------|
|         |        |                     | copper                  | cold-rolled steel | hard steel HRC35 | stainless steel 304 |      |
| YT-1963 | 200    | 40                  | 1.5                     | 1.0               | 0.6              | 0.6                 | 6/36 |
| YT-1964 | 250    | 60                  | 1.8                     | 1.2               | 0.8              | 0.8                 | 6/24 |
| YT-1965 | 300    | 75                  | 2.0                     | 1.4               | 0.8              | 0.8                 | 6/12 |



| YATO    | L (mm) | cutting length (mm) | cutting capacities (mm) |                   |                  |                     | 6/36 |
|---------|--------|---------------------|-------------------------|-------------------|------------------|---------------------|------|
|         |        |                     | copper                  | cold-rolled steel | hard steel HRC35 | stainless steel 304 |      |
| YT-1970 | 260    | 42                  | 2.0                     | 1.4               | 1.0              | 1.0                 | 6/36 |



- GB Steel strap cutter  
D Stahlgurtblechscherer  
PL Nożyce do cięcia taśmy stalowej  
RUS Ножницы для резки стальной ленты  
CZ Nůžky na plech  
H Lemezvágó olló  
RO Foarfece pt. tablă  
F Cisaille à bande acier  
I Cesioia per taglio reggetta in acciaio  
E Tijeras para bandejas de acero  
CN 钢带剪

HRC  
58-61

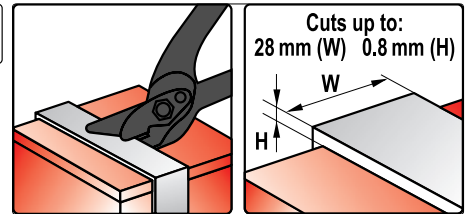

| YATO    | L (mm) | cutting length (mm) | cutting capacities (mm) |                   |                  |                     | 6/24 |
|---------|--------|---------------------|-------------------------|-------------------|------------------|---------------------|------|
|         |        |                     | copper                  | cold-rolled steel | hard steel HRC35 | stainless steel 304 |      |
| YT-1930 | 305    | 28                  | -                       | 1.00              | 0.80             | 0.60                |      |

- GB Portable notchers  
D Schere zum Ausschneiden von Ecken  
PL Nożyce do wycinania naroży  
RUS Ножницы для наружных углов  
CZ Nůžky na vystřihování rohů  
H Sarokkivágó olló
- RO Foarfece pt. taierea colturilor  
F Ciseaux pour le coupage des coins  
I Cesioie per taglio reggetta in angoli  
E Tijera para esquinas  
CN 截角器

300 mm 90°

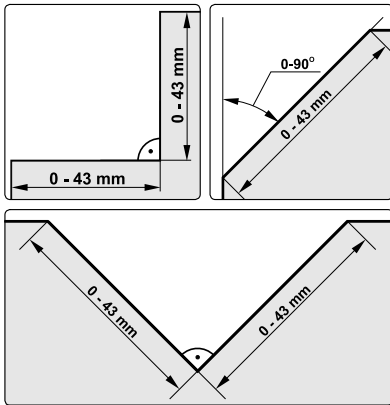

| YATO    | L (mm) | 15 |
|---------|--------|----|
| YT-1939 | 300    |    |

- GB Straight pliers  
D Zange zum Blechbiegen  
PL Kleszcze do gięcia blach  
RUS Клещи с тупым ножом для жести  
CZ Kleště na ohýbání plechu  
H Falcfogó  
RO Cleste pt. indoirea tablei
- F Pince à fléchir la tôle  
I Taglie per la lamiera  
E Tenazas para doblar hojalata  
CN 钣金钳



45° 55 mm

90° 55 mm

180° 60 mm















| YATO    | L (mm) | 10/20 | YATO    | L (mm) | 10/20 | YATO    | L (mm) | 10/20 |
|---------|--------|-------|---------|--------|-------|---------|--------|-------|
| YT-5416 | 280    |       | YT-5417 | 260    |       | YT-5415 | 280    |       |

# 18

**Power & gasoline tools**  
**Elektronarzędzia**  
**i narzędzia spalinowe**





|   |   |         |   |   |         |
|---|---|---------|---|---|---------|
| Angle grinders<br>Szlifierki kątowe           |    | 392     | Multi-purpose oscillating tools<br>Wielofunkcyjne narzędzia oscylacyjne |    | 399     |
| Drilling machines<br>Wiertarki                |    | 393-394 | Hot air guns<br>Opalarki  |    | 400     |
| Drywall screwdrivers<br>Wkrętarki do regipsów |    | 394     | Knives<br>Noże  |    | 401     |
| Rotary hammers<br>Młotowiertarki              |    | 395     | Pipe welders<br>Zgrzewarki do rur                                       |    | 401     |
| Jig saws<br>Wyrzynarki                        |    | 396     | Generators<br>Generatory  |    | 402-403 |
| Circular saws<br>Pilarki tarczowe             |    | 397     | Pumps<br>Pompy  |    | 404     |
| Planers<br>Strugi                             |  | 397     | Electric hoists<br>Elektryczne wciągarki linowe                         |  | 405     |
| Miter saws<br>Ukośnice                        |  | 398     | Burners & soldering tools<br>Palniki i lutownice                        |  | 406-408 |
| Sabre saws<br>Piły szablaste                  |  | 398     | Glue guns<br>Pistolety do klejenia                                      |  | 409     |

- GB Angle grinder
- D Winkelschleifmaschine
- PL Szlifierka kątowa
- RUS Угловой шлифовальный станок
- CZ Úhlová bruska
- H Sarokcsiszológ
- RO Polizor unghiular
- F Meuleuse d'angle
- I Smelgiatrice angolare
- E Lijadera de angulo
- CN 角向磨光机



|                            |           |
|----------------------------|-----------|
| 230V~<br>50Hz              | 710<br>W  |
| 11000<br>min <sup>-1</sup> | 115<br>mm |
| M14                        |           |

COLOR  
BOX

| YATO     | W   |   |
|----------|-----|---|
| YT-82090 | 710 | 6 |

- GB Angle grinder
- D Winkelschleifmaschine
- PL Szlifierka kątowa
- RUS Угловой шлифовальный станок
- CZ Úhlová bruska
- H Sarokcsiszológ
- RO Polizor unghiular
- F Meuleuse d'angle
- I Smelgiatrice angolare
- E Lijadera de angulo
- CN 角向磨光机



|                            |           |
|----------------------------|-----------|
| 230V~<br>50Hz              | 950<br>W  |
| 11000<br>min <sup>-1</sup> | 125<br>mm |
| M14                        |           |

COLOR  
BOX

| YATO     | W   |   |
|----------|-----|---|
| YT-82095 | 950 | 6 |

- GB Angle grinder
- D Winkelschleifmaschine
- PL Szlifierka kątowa
- RUS Угловой шлифовальный станок
- CZ Úhlová bruska
- H Sarokcsiszológ
- RO Polizor unghiular
- F Meuleuse d'angle
- I Smelgiatrice angolare
- E Lijadera de angulo
- CN 角向磨光机



|                           |           |
|---------------------------|-----------|
| 230V~<br>50Hz             | 2200<br>W |
| 6000<br>min <sup>-1</sup> | 230<br>mm |
| M14                       |           |

COLOR  
BOX



| YATO     | W    |   |
|----------|------|---|
| YT-82102 | 2200 | 2 |



- GB Impact drill
- D Schlagbohrmaschine
- PL Wiertarka udarowa
- RUS Ударная дрель
- CZ Nárazová vrtačka
- H Kezelési utasítás
- RO Masina de gaurit
- F Perceuse à percussion
- I Trapano a percussione
- E Taladradora de percusión
- CN 冲击钻





COLOR  
BOX

| YATO  | W   |  |
|--|-----|---|
| YT-82030   | 550 | 5   |

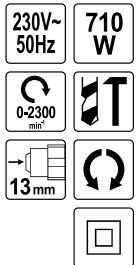
- GB Impact drill
- D Schlagbohrmaschine
- PL Wiertarka udarowa
- RUS Ударная дрель
- CZ Nárazová vrtačka
- H Kezelési utasítás
- RO Masina de gaurit
- F Perceuse à percussion
- I Trapano a percussione
- E Taladradora de percusión
- CN 冲击钻





COLOR  
BOX

| YATO  | W   |  |
|--|-----|---|
| YT-82035   | 710 | 5   |

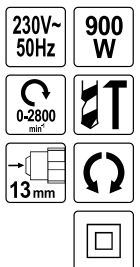
- GB Impact drill
- D Schlagbohrmaschine
- PL Wiertarka udarowa
- RUS Ударная дрель
- CZ Nárazová vrtačka
- H Kezelési utasítás
- RO Masina de gaurit
- F Perceuse à percussion
- I Trapano a percussione
- E Taladradora de percusión
- CN 冲击钻









COLOR  
BOX



| YATO  | W   |  |
|--|-----|---|
| YT-82040   | 900 | 5   |

- GB Electric drill
- D Elektrobohrmaschine
- PL Wiertarka elektryczna
- RUS Электрическая дрель
- CZ Elektrická vrtačka
- H Elektromos fúrógép
- RO Mașină de găurit electrică
- F Perceuse à métal
- I Trapano
- E Taladro eléctrico
- CN 电钻









|   |   |   |
|---|---|---|
| 230V~<br>50Hz   | 550<br>W  | 0-2700<br>min <sup>1</sup>  |
| 10 mm   |        |  |
|  20 mm |  10 mm |  |
|        |   |   |

COLOR  
BOX



| YATO  | W   |  |
|--|-----|---|
| YT-82050   | 550 | 5   |

- GB Electric drill
- D Elektrobohrmaschine
- PL Wiertarka elektryczna
- RUS Электрическая дрель
- CZ Elektrická vrtačka
- H Elektromos fúrógép
- RO Mașină de găurit electrică
- F Perceuse à métal
- I Trapano
- E Taladro eléctrico
- CN 电钻



|  |  |  |
|--|--|--|
| 230V~<br>50Hz  | 580<br>W   | 0-1300<br>min <sup>1</sup>   |
| 10 mm  |         |   |
|  25 mm |  10 mm |  |
|       |  |  |

COLOR  
BOX



| YATO  | W   |  |
|--|-----|---|
| YT-82051   | 580 | 5   |

- GB Drywall screwdriver
- D Trockenbauschrauber
- PL Wkrętarka elektryczna
- RUS Сетевой шуруповёрт
- CZ Sádrokartonářský šroubovák
- H Gipszkarton csavarzó
- RO Șurubelniță pt. gips-carton
- F Perceuse aux plaques de plâtre
- I Trapano
- E Atornilladores para construcción en seco
- CN 墙板螺丝刀



|  |  |   |
|--|--|---|
| 230V~<br>50Hz  | 500<br>W   | 0-1600<br>min <sup>1</sup>  |
|         |  1/4" |  |
|  6.3 mm |       |   |
|         |  |   |

COLOR  
BOX

| YATO  | W   |  |
|--|-----|---|
| YT-82070   | 500 | 5   |



GB Rotary hammer  
D Bohrhammer  
PL Młotowiertarka SDS-plus  
RUS Перфоратор  
CZ Vrtací kladivo  
H Fűrőkalapács  
RO Ciocan rotopercutor  
F Marteau perforateur  
I Martello rotativo  
E Martillo perforador  
CN 电锤

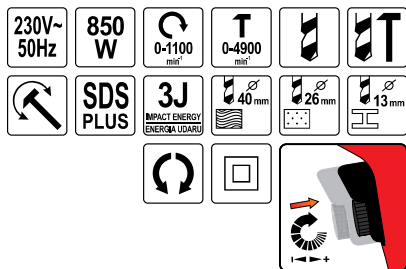

BMC  
& COLOR  
SLEEVE

|             |     |   |
|-------------|-----|---|
| <b>YATO</b> | W   |   |
| YT-82120    | 850 | 2 |

GB Rotary hammer  
D Bohrhammer  
PL Młotowiertarka SDS-plus  
RUS Перфоратор  
CZ Vrtací kladivo  
H Fűrőkalapács  
RO Ciocan rotopercutor  
F Marteau perforateur  
I Martello rotativo  
E Martillo perforador  
CN 电锤

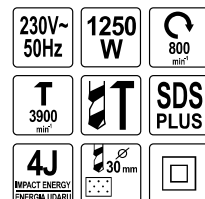

BMC  
& COLOR  
SLEEVE

|             |      |   |
|-------------|------|---|
| <b>YATO</b> | W    |   |
| YT-82125    | 1250 | 2 |

GB Rotary hammer  
D Bohrhammer  
PL Młotowiertarka SDS-plus  
RUS Перфоратор  
CZ Vrtací kladivo  
H Fűrőkalapács  
RO Ciocan rotopercutor  
F Marteau perforateur  
I Martello rotativo  
E Martillo perforador  
CN 电锤

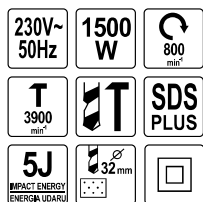

BMC  
& COLOR  
SLEEVE

|             |      |   |
|-------------|------|---|
| <b>YATO</b> | W    |   |
| YT-82127    | 1500 | 2 |

GB Rotary hammer  
D Bohrhammer  
PL Młotowiertarka SDS-max  
RUS Перфоратор  
CZ Vrtací kladivo  
H Fűrőkalapács  
RO Ciocan rotopercutor  
F Marteau perforateur  
I Martello rotativo  
E Martillo perforador  
CN 电锤

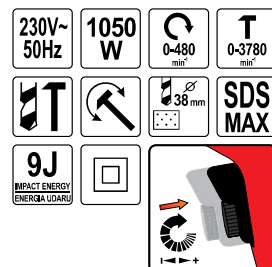

BMC  
& COLOR  
SLEEVE



|             |      |   |
|-------------|------|---|
| <b>YATO</b> | W    |   |
| YT-82130    | 1050 | 2 |

- GB Jig saw
- D Stichsäge
- PL Wyrzynarka
- RUS Электрический лобзик
- CZ Přímočará pila
- H Szűrőfűrész
- RO Ferăstrău pt. traforaj
- F Scie sauteuse
- I Seghetto alternativo
- E Sierra de calar
- CN 曲线锯



|                             |   |
|-----------------------------|---|
| 230V~<br>50Hz               | 550<br>W  |
| 800-2600<br>mm <sup>2</sup> | 65<br>mm  |
| 6 mm                        |  |

COLOR  
BOX



| YATO  | W   |  |
|--|-----|---|
| YT-82270   | 550 | 5   |

- GB Jig saw
- D Stichsäge
- PL Wyrzynarka
- RUS Электрический лобзик
- CZ Přímočará pila
- H Szűrőfűrész
- RO Ferăstrău pt. traforaj
- F Scie sauteuse
- I Seghetto alternativo
- E Sierra de calar
- CN 曲线锯



|                             |   |
|-----------------------------|---|
| 230V~<br>50Hz               | 750<br>W  |
| 800-3000<br>mm <sup>2</sup> | 80<br>mm  |
| 6 mm                        |  |

COLOR  
BOX



| YATO  | W   |  |
|--|-----|---|
| YT-82271   | 750 | 5   |

- GB Jig saw
- D Stichsäge
- PL Wyrzynarka
- RUS Электрический лобзик
- CZ Přímočará pila
- H Szűrőfűrész
- RO Ferăstrău pt. traforaj
- F Scie sauteuse
- I Seghetto alternativo
- E Sierra de calar
- CN 曲线锯



|                             |   |
|-----------------------------|---|
| 230V~<br>50Hz               | 750<br>W  |
| 800-3000<br>mm <sup>2</sup> | 110<br>mm   |
| 10 mm                       |  |

COLOR  
BOX

| YATO  | W   |  |
|--|-----|---|
| YT-82272   | 750 | 5   |





- GB Circular saw
- D Handkreissäge
- PL Piłarka
- RUS Дисковая пила
- CZ Ručna kružna pila
- H Kézi körfűrész
- RO Ferăstrău circular de mana
- F Tronçonneuse
- I Sega circolare
- E Sierra circular
- CN 电圆锯



|   |           |
|---|-----------|
| 230V~<br>50Hz   | 1300<br>W |
| 5000<br>min <sup>-1</sup>   | ∅190 mm   |
|  |           |

COLOR  
BOX



| YATO  | W    |  |
|--|------|---|
| YT-82150   | 1300 | 2   |

- GB Circular saw
- D Handkreissäge
- PL Piłarka
- RUS Дисковая пила
- CZ Ručna kružna pila
- H Kézi körfűrész
- RO Ferăstrău circular de mana
- F Tronçonneuse
- I Sega circolare
- E Sierra circular
- CN 电圆锯



|   |           |
|---|-----------|
| 230V~<br>50Hz   | 2000<br>W |
| 4500<br>min <sup>-1</sup>   | ∅235 mm   |
|  |           |

COLOR  
BOX



| YATO  | W    |  |
|--|------|--|
| YT-82153   | 2000 | 2  |

- GB Electric planer
- D Elektrohobel
- PL Strug elektryczny
- RUS Электрорубанок
- CZ Elektrický hoblík
- H Elektromos gyalu
- RO Rindea electrica
- F Rabot
- I Piatta elettrica
- E Garlopa electrica
- CN 电刨



|                              |   |
|------------------------------|---|
| 230V~<br>50Hz                | 1050<br>W   |
| 0-16000<br>min <sup>-1</sup> | 0-3<br>mm   |
| 82 mm                        |  |

COLOR  
BOX

| YATO  | W    |  |
|--|------|---|
| YT-82140   | 1050 | 4   |

- GB Mitre saw
- D Paneelsäge
- PL Ukośnica
- RUS Панельная пила
- CZ Pokosová pila se základem
- H Sínes gérvágó
- RO Ferăstrău circular staționar
- F Scie à onglet radiale
- I Segha angolare taglio leghe
- E Ingletadora telescópica
- CN 斜切锯

|   |           |
|---|-----------|
| 230V~<br>50Hz   | 1800<br>W |
| 4800<br>min <sup>-1</sup>   | ∅255mm    |
|  |           |

- GB Mitre saw
- D Paneelsäge
- PL Ukośnica
- RUS Панельная пила
- CZ Pokosová pila se základem
- H Sínes gérvágó
- RO Ferăstrău circular staționar
- F Scie à onglet radiale
- I Segha angolare taglio leghe
- E Ingletadora telescópica
- CN 斜切锯

|   |           |
|---|-----------|
| 230V~<br>50Hz   | 1800<br>W |
| 4800<br>min <sup>-1</sup>   | ∅255mm    |
|  |           |



COLOR  
BOX

|             |      |   |
|-------------|------|---|
| <b>YATO</b> | W    |  |
| YT-82170    | 1800 | 1   |



COLOR  
BOX

|             |      |   |
|-------------|------|---|
| <b>YATO</b> | W    |  |
| YT-82171    | 1800 | 1   |

- GB Reciprocating saw
- D Säbelsäge
- PL Pila szablasta
- RUS Сабельная пила
- CZ Pila ocaska
- H Szablyafűrész
- RO Ferăstrău tip sabie
- F Scie sabre
- I Segha elettrica alternativa
- E Serra de sabre
- CN 往复锯



|                               |   |
|-------------------------------|---|
| 230V~<br>50Hz                 | 1200<br>W   |
| 800-2800<br>min <sup>-1</sup> | 210<br>mm   |
| 10mm                          |  |



COLOR  
BOX

|             |      |   |
|-------------|------|---|
| <b>YATO</b> | W    |  |
| YT-82280    | 1200 | 4   |



- GB Multi-purpose oscillating tool
- D Multifunktionales Oszillationswerkzeug
- PL Wielofunkcyjne narzędzie oscylacyjne
- RUS Многофункциональный инструмент
- CZ Multifunkční oscilační nářadí
- H Multifunkciós rezgő szerszám
- RO Unealtă multifuncțională oscilantă
- F Outil multifonctions oscillant
- I Oscillante strumento multifunzione
- E Herramienta oscilatoria multiusos
- CN 多功能啊雄莓



230V~  
50Hz

300  
W

15000-22000  
mm<sup>2</sup>

BMC  
& COLOR  
SLEEVE

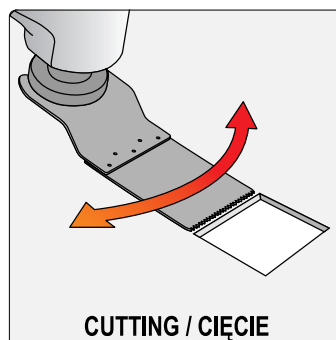
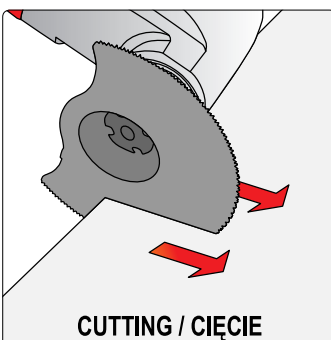
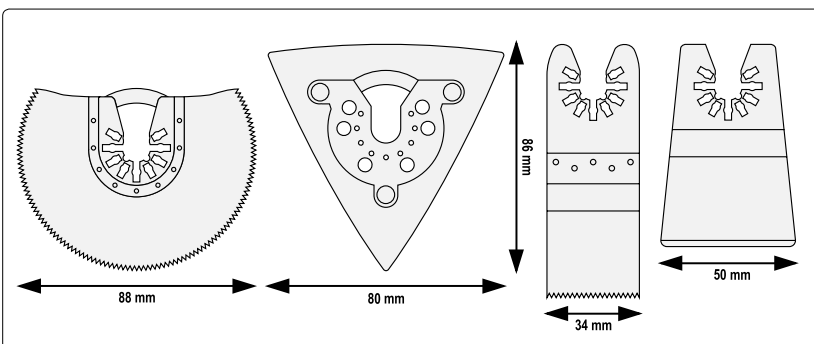
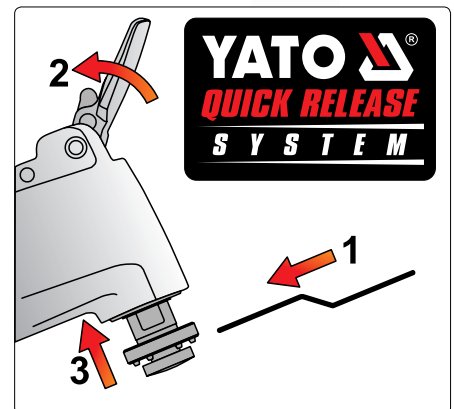

|   |     |   |
|---|-----|---|
| <b>YATO</b>  | W   |  |
| YT-82220  | 300 | 4   |

GB Hot air gun  
 D Heissluftpistole  
 PL Opalarka  
 RUS Фен для обжигания краски  
 CZ Opalovací stroj  
 H Hőlégfúvó  
 RO Fion pt. ars vopseaua  
 F Décapeur thermique  
 I Generatore aria calda  
 E Secadora  
 CN 热风枪

230V~50Hz 2000 W 550°C  
 500 l/min



COLOR BOX

|             |      |    |
|-------------|------|----|
| <b>YATO</b> | W    |    |
| YT-82288    | 2000 | 10 |

GB Hot air gun with accessories  
 D Heissluftpistole  
 PL Opalarka z akcesoriami  
 RUS Фен для обжигания краски в наборе  
 CZ Opalovací stroj s příslušenstvím  
 H Hőlégfúvó tartozékokkal  
 RO Fion cu accesorii pt. ars vopseaua  
 F Décapeur thermique  
 I Generatore aria calda con accessori  
 E Secadora con accesorios  
 CN 热风枪

230V~50Hz 2000 W 550°C  
 500 l/min



BMC & COLOR SLEEVE

|             |      |   |
|-------------|------|---|
| <b>YATO</b> | W    |   |
| YT-82291    | 2000 | 5 |

GB Hot air gun with accessories  
 D Heissluftpistole  
 PL Opalarka z akcesoriami  
 RUS Фен для обжигания краски в наборе  
 CZ Opalovací stroj s příslušenstvím  
 H Hőlégfúvó tartozékokkal  
 RO Fion cu accesorii pt. ars vopseaua  
 F Décapeur thermique  
 I Generatore aria calda con accessori  
 E Secadora con accesorios  
 CN 热风枪

230V~50Hz 2000 W 550°C  
 500 l/min  
 LED

TEMPERATURE ADJUSTMENT



REGULACJA TEMPERATURY

GB Hot air gun with accessories  
 D Heissluftpistole  
 PL Opalarka z akcesoriami  
 RUS Фен для обжигания краски в наборе  
 CZ Opalovací stroj s příslušenstvím  
 H Hőlégfúvó tartozékokkal  
 RO Fion cu accesorii pt. ars vopseaua  
 F Décapeur thermique  
 I Generatore aria calda con accessori  
 E Secadora con accesorios  
 CN 热风枪

230V~50Hz 2000 W 600°C  
 500 l/min  
 LCD DISPLAY

TEMPERATURE ADJUSTMENT



REGULACJA TEMPERATURY



BMC & COLOR SLEEVE

|             |      |   |
|-------------|------|---|
| <b>YATO</b> | W    |   |
| YT-82292    | 2000 | 5 |



BMC & COLOR SLEEVE

|             |      |   |
|-------------|------|---|
| <b>YATO</b> | W    |   |
| YT-82293    | 2000 | 5 |



GB Thermal knife for polystyrene foam  
D Thermomesser für Styropor  
PL Nóż termiczny do styropianu  
RUS Термонож для пенопласта

CZ Termický nůž na pěnový polystyrén  
H Polisztírol vágó hőkés  
RO Cuițit termic pt. stiropian  
F Couteau thermique à styrofoam

I Coltello termico per polistirolo  
E Cuchilla térmica para poliestireno  
CN 热切割刀

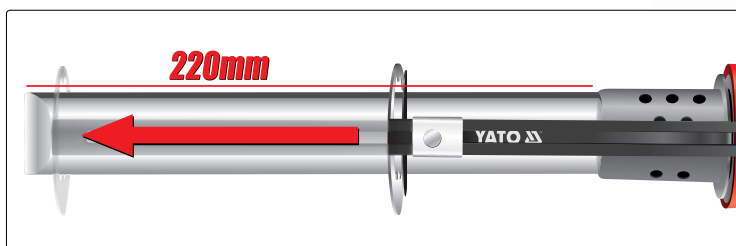
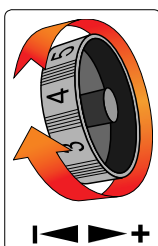
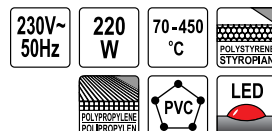

COLOR BOX



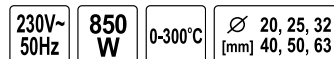

| YATO  | W   | L (mm) |  |
|--|-----|--------|---|
| YT-82190   | 220 | 220    | 10  |

GB PVC plastic pipe welder  
D Schweissgerät für thermoplastische Rohre  
PL Zgrzewarka do rur termoplastycznych  
RUS Сварочная машина для термопластиковых труба  
CZ Svářečka na termoplastické trubky  
H Hegesztő berendezés termoplasztikus csövekhez  
RO Masina de sudat tevi termoplastice  
F Soudeur en tuyauterie en PVC  
I Polifusore saldatore per tubi  
E Maquina de soldar las tubos termoplasticos  
CN 热熔器



METAL CASE & COLOR BOX



| YATO  | W   |  |
|--|-----|---|
| YT-82250   | 850 | 2   |

GB Gasoline generator  
 D Stromgenerator  
 PL Generator prądowórczy  
 RUS Генератор тока  
 CZ Generátor vytvářející proud  
 H Áramfejlesztő generátorhoz  
 RO Generator de curent  
 F Groupe électrogène  
 I Generatore di corrente  
 E Generator de corriente  
 CN 姆柏发电机



230V-50Hz  
 2x   
**2.5 kW**  
 196 cm<sup>3</sup>   
**15 l**   
**10.9 A**

GB Gasoline generator  
 D Stromgenerator  
 PL Generator prądowórczy  
 RUS Генератор тока  
 CZ Generátor vytvářející proud  
 H Áramfejlesztő generátorhoz  
 RO Generator de curent  
 F Groupe électrogène  
 I Generatore di corrente  
 E Generator de corriente  
 CN 姆柏发电机



230V-50Hz  
 2x   
**3.2 kW**  
 242 cm<sup>3</sup>   
**25 l**   
**13.9 A**



GREY  
 CARTON BOX  
 & COLOR  
 LABEL



GREY  
 CARTON BOX  
 & COLOR  
 LABEL



| YATO     | kW  |   |
|----------|-----|---|
| YT-85432 | 2.5 | 1 |

| YATO     | kW  |   |
|----------|-----|---|
| YT-85434 | 3.2 | 1 |

GB Gasoline generator  
 D Stromgenerator  
 PL Generator prądowórczy  
 RUS Генератор тока  
 CZ Generátor vytvářející proud  
 H Áramfejlesztő generátorhoz  
 RO Generator de curent  
 F Groupe électrogène  
 I Generatore di corrente  
 E Generator de corriente  
 CN 姆柏发电机



230V-50Hz  
 2x   
**4.0 kW**  
 389 cm<sup>3</sup>   
**25 l**   
**17.4 A**

GB Gasoline generator  
 D Stromgenerator  
 PL Generator prądowórczy  
 RUS Генератор тока  
 CZ Generátor vytvářející proud  
 H Áramfejlesztő generátorhoz  
 RO Generator de curent  
 F Groupe électrogène  
 I Generatore di corrente  
 E Generator de corriente  
 CN 姆柏发电机



230V-50Hz  
 2x   
**5.0 kW**  
 389 cm<sup>3</sup>   
**25 l**   
**21.7 A**



GREY  
 CARTON BOX  
 & COLOR  
 LABEL



GREY  
 CARTON BOX  
 & COLOR  
 LABEL



| YATO     | kW  |   |
|----------|-----|---|
| YT-85437 | 4.0 | 1 |

| YATO     | kW  |   |
|----------|-----|---|
| YT-85440 | 5.0 | 1 |



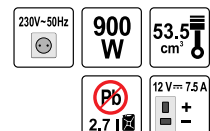

GB Gasoline generator  
D Stromgenerator  
PL Generator prądowórczy  
RUS Генератор тока  
CZ Generátor vytvářející proud  
H Áramfejlesztő generátorhoz  
RO Generator de curent  
F Groupe électrogène  
I Generatore di corrente  
E Generator de corriente  
CN 发电机



# YG 1000

COLOR BOX



| YATO  | W   |  |
|--|-----|---|
| YT-85421   | 900 | 1   |

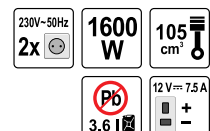

GB Gasoline generator  
D Stromgenerator  
PL Generator prądowórczy  
RUS Генератор тока  
CZ Generátor vytvářející proud  
H Áramfejlesztő generátorhoz  
RO Generator de curent  
F Groupe électrogène  
I Generatore di corrente  
E Generator de corriente  
CN 发电机



# YG 2000

COLOR BOX



| YATO  | W    |  |
|--|------|---|
| YT-85422   | 1600 | 1   |



- GB Gasoline water pump
- D Pumpe mit verbrennungsmotor
- PL Pompa spalinowa
- RUS Бензонасос
- CZ Čerpadlo  
se spalovacím motorem
- H Robbanómotoros szivattyú
- RO Pompa cu motor  
cu ardere internă
- F Pompe à eau
- I Motorpompa
- E Bomba de combustion
- CN 汽油抽水泵



|                                      |   |
|--------------------------------------|---|
| 4.1 kW                               |  |
| 163 cm <sup>3</sup>                  |  |
| Q <sub>MAX</sub> 36m <sup>3</sup> /h |  |
| 3.6 l                                |  |

COLOR BOX



|   |   |
|---|---|
| <b>YATO</b>  |  |
| YT-85401  | 1   |

- GB Gasoline water pump
- D Pumpe mit verbrennungsmotor
- PL Pompa spalinowa
- RUS Бензонасос
- CZ Čerpadlo  
se spalovacím motorem
- H Robbanómotoros szivattyú
- RO Pompa cu motor  
cu ardere internă
- F Pompe à eau
- I Motorpompa
- E Bomba de combustion
- CN 汽油抽水泵



|                                      |   |
|--------------------------------------|---|
| 4.1 kW                               |    |
| 163 cm <sup>3</sup>                  |    |
| Q <sub>MAX</sub> 60m <sup>3</sup> /h |   |
| 3.6 l                                |  |

COLOR BOX



|   |   |
|---|---|
| <b>YATO</b>  |  |
| YT-85402  | 1   |

- GB Gasoline water pump
- D Pumpe mit verbrennungsmotor
- PL Pompa spalinowa
- RUS Бензонасос
- CZ Čerpadlo  
se spalovacím motorem
- H Robbanómotoros szivattyú
- RO Pompa cu motor  
cu ardere internă
- F Pompe à eau
- I Motorpompa
- E Bomba de combustion
- CN 汽油抽水泵



|                                      |   |
|--------------------------------------|---|
| 4.1 kW                               |  |
| 242 cm <sup>3</sup>                  |  |
| Q <sub>MAX</sub> 96m <sup>3</sup> /h |  |
| 3.6 l                                |  |

COLOR BOX



|   |   |
|---|---|
| <b>YATO</b>  |  |
| YT-85403  | 1   |



- GB Electric hoist
- D Elektro-Seilwinde
- PL Elektryczny wciągnik linowy
- RUS Электрическая канатная лебёдка
- CZ Elektrický naviják kladkostroj
- H Elektromos csőrió
- RO Troliu electric cu cablu
- F Treuil électrique à corde
- I Verricello elettrico
- E Cabría eléctrica de cuerdas
- CN 电动葫芦



COLOR  
BOX



~230V  
50Hz





**500W**  

|   |     |   |
|---|-----|---|
| <b>YATO</b>  | W   |  |
| YT-5901   | 500 | 2   |

8 m/min  
max.  
11m  
125 kg

4 m/min  
max.  
5.5m  
250 kg



**550W**  

|   |     |   |
|---|-----|---|
| <b>YATO</b>  | W   |  |
| YT-5902   | 550 | 2   |

8 m/min  
max.  
11m  
150 kg

4 m/min  
max.  
5.5m  
300 kg



**900W**  

|   |     |   |
|---|-----|---|
| <b>YATO</b>  | W   |  |
| YT-5904   | 900 | 2   |

8 m/min  
max.  
11m  
250 kg

4 m/min  
max.  
5.5m  
500 kg

**1050W**  

|   |      |   |
|---|------|---|
| <b>YATO</b>  | W    |  |
| YT-5905   | 1050 | 2   |

8 m/min  
max.  
11m  
300 kg

4 m/min  
max.  
5.5m  
600 kg

GB Gas torch  
D Gasbrenner  
PL Palnik gazowy  
RUS Газовая паяльная лампа  
CZ Plynový hořák  
H Gázégő

RO Arzător de gaz  
F Bruleur à gaz  
I Saldatore bruciatore a gas  
E Soplete de gas  
CN 火焰枪

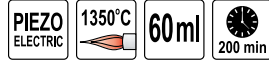

**YATO** YT-6700 6/24

GB Gas torch  
D Gasbrenner  
PL Palnik gazowy  
RUS Газовая паяльная лампа  
CZ Plynový hořák  
H Gázégő

RO Arzător de gaz  
F Bruleur à gaz  
I Saldatore bruciatore a gas  
E Soplete de gas  
CN 火焰枪

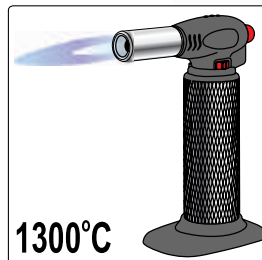

**YATO** YT-36700 10/20

GB Butane soldering tool  
D Gaslötkolben  
PL Lutownica gazowa  
RUS Паяльник газовый  
CZ Plynová pájka  
H Forrasztópisztoly ceruza bután gáz üzemű  
RO Surubelnita sudura cu gaz  
F Fer à souder à gaz  
I Saldatore a gas  
E Microsoldador de butano portátil  
CN 瓦斯焊接工具



**YATO** YT-6705 W 12/72

GB Soldering tool set  
D Gaslötkolben satz  
PL Lutownica gazowa z akcesoriami  
RUS Газовый паяльный набор  
CZ Plynova pajka souprava  
H Gaz forrasztópáka készletek

RO Set ciocan de lipit cu gaz  
F Fer à souder à gaz  
I Saldatore a gas  
E Soldador a gas con accesorios  
CN 自动点火多功能瓦斯组套

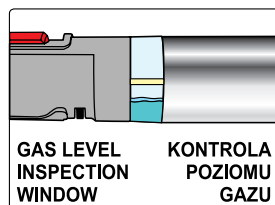
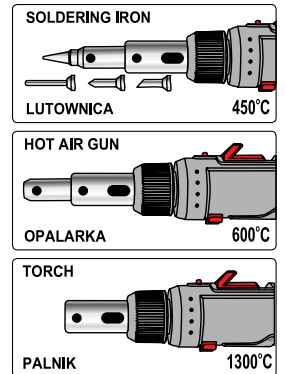
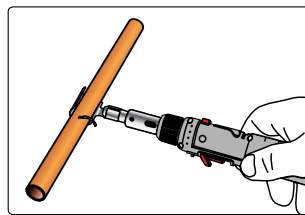

**YATO** YT-36706 W 6



- GB Butane soldering tool  
D Gaslötkolben  
PL Lutownica gazowa  
RUS Паяльник газовый  
CZ Plynová pájka  
H Forrasztópisztoly ceruza bután gáz üzemű
- RO Surubelnita sudura cu gaz  
F Fer à souder à gaz  
I Saldatore a gas  
E Microsoldador de butano portátil  
CN 瓦斯焊接工具

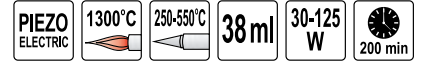

SLIDING CARD



|             |        |       |
|-------------|--------|-------|
| <b>YATO</b> | W      |       |
| YT-6706     | 30-125 | 12/48 |

- GB Soldering tool 3 in 1  
D Gaslötkolben 3 in 1  
PL Lutownica gazowa 3 w 1  
RUS Газовый паяльник 3-в-1  
CZ Plynova pájka 3 in 1  
H Gaz-forrasztópaka 3 in 1  
RO Ciocan de lipit cu gaz 3 in 1
- F Fer à souder à gaz  
I Saldatore a gas  
E Soldador de gas 3 in 1  
CN 瓦斯焊接工具

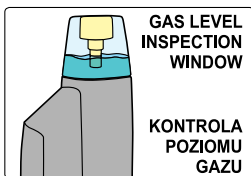
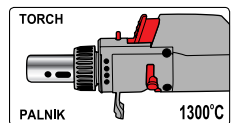
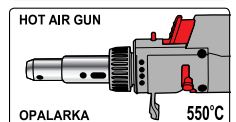
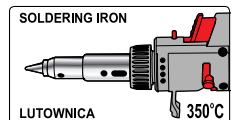

SLIDING CARD



|             |       |       |
|-------------|-------|-------|
| <b>YATO</b> | W     |       |
| YT-36704    | 30-70 | 12/72 |

- GB Gas blow torch  
D Lötbrenner  
PL Palnik gazowy  
RUS Газовая горелка  
CZ Plynový hořák  
H Gázégő
- RO Arzător de gaz  
F Bruleur à gaz  
I Saldatore bruciatore a gas  
E Soplete de gas  
CN 火焰枪

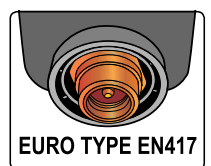
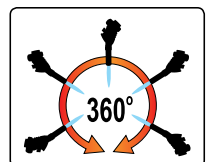
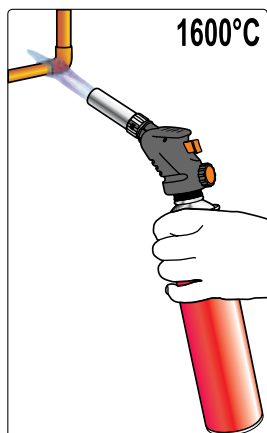

SLIDING CARD



|             |      |      |
|-------------|------|------|
| <b>YATO</b> | KW   |      |
| YT-36709    | 1.28 | 6/12 |

- GB Soldering iron
- D LötKolben
- PL Lutownica orowowa
- RUS Электропаяльник
- CZ Pájka odporová
- H Forrasztópáka
- RO Ciocan de lipit
- F Fer à souder
- I Saldatore a stagno
- E Soldador de resistencia
- CN 电烙铁



HANGING DISPLAY COLOR BOX



230V~50Hz

| YATO    | W  | working temp. of soldering tip (°C) | dimensions of soldering tip (mm) |    |
|---------|----|-------------------------------------|----------------------------------|----|
| YT-8271 | 30 | 400                                 | ø3.8 x 70                        | 16 |
| YT-8272 | 60 | 500                                 | ø6.0 x 78                        | 16 |
| YT-8273 | 80 | 520                                 | ø6.8 x 64                        | 16 |

- GB Transformer soldering gun
- D Lötpestole
- PL Lutownica transformatorowa
- RUS Паяльник электрический
- CZ Transformátorová páječka
- H Forrasztópáka
- RO Aparat de lipit letcon cu transformator
- F Fer à souder
- I Saldatore istantaneo
- E Soldador transformador
- CN 电烙铁



230V~50Hz

180 W

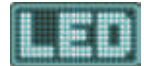

BMC & COLOR SLEEVE



| YATO    | W   |    |
|---------|-----|----|
| YT-8245 | 180 | 10 |

- GB Soldering station
- RO Stație de lipit
- D Lötstation
- F Station de soudage
- PL Stacja lutownicza
- I Stazione digitale di saldatura
- RUS Паяльная станция
- E Estación de soldadura
- CZ Letovací stanice
- CN 数显焊台
- H Forrasztópáka állomás

230V~50Hz

48W

150-450 °C

7.1 mm 65 mm

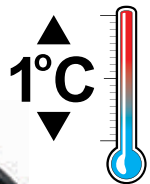

COLOR BOX



| YATO     | W  |   |
|----------|----|---|
| YT-82455 | 48 | 4 |





# 19

## Padlocks & lock cylinders Kłódki i wkładki do zamków





Brass padlocks  
Kłódki mosiężne

412



Lock cylinders  
Wkładki do zamków

413



Arbor padlocks  
Kłódki trzpieniowe

412



Brass lock cylinders

Wkładki mosiężne..... 413



Brass lock cylinders with knob

Wkładki mosiężne z gałką..... 413

- GB Brass padlock
- D Vorhängeschloss
- PL Klódka mosiężna
- RUS Стержневой навесной латунный
- CZ Zámek visací mosazný
- H Lakat sárgaréz
- RO Lacăt alama
- F Cadenas laiton nickelé
- I Lucchetto in ottone
- E Candado de latón
- CN 铜挂锁





DOUBLE BLISTER

| YATO  | L (mm) |  |
|--|--------|---|
| YT-6966  | 60     | 6/36  |

- GB Arbor brass padlock
- D Vorhängeschloss
- PL Klódka trzpieniowa
- RUS Стержневой навесной замок чугунный
- CZ Stavební visací zámek
- H Oriás lakat
- RO Lacăt
- F Cadenas laiton acier rectangulaire
- I Lucchetto rettangolare
- E Candado de mandril de hierro fundido cubierto
- CN 挂锁





DOUBLE BLISTER

| YATO  | L (mm) |  |
|--|--------|---|
| YT-6980  | 40     | 6/96  |
| YT-6981  | 50     | 6/72  |
| YT-6982  | 60     | 6/60  |
| YT-6983  | 70     | 6/36  |
| YT-6984  | 80     | 6/30  |
| YT-6985  | 90     | 6/24  |

- GB Arbor brass padlock
- D Vorhängeschloss
- PL Klódka trzpieniowa
- RUS Стержневой навесной замок чугунный
- CZ Stavební visací zámek
- H Oriás lakat
- RO Lacăt
- F Cadenas laiton rectangulaire nickelé
- I Lucchetto rettangolare
- E Candado de mandril de hierro fundido cubierto
- CN 挂锁



DOUBLE BLISTER

| YATO  | L (mm) |  |
|--|--------|---|
| YT-6986  | 40     | 6/48  |
| YT-6987  | 50     | 6/48  |
| YT-6989  | 70     | 6/24  |



GB Lock cylinder  
D Schliesszylinder  
PL Wkładka do zamka  
RUS Замок цилиндрический  
CZ Vložka na zámek  
H Zárbetét  
RO Yală pt. broască  
F Serrure à encastrer  
I Cilindro con pomolo  
E Inserción de latón  
CN 锁芯

BRASS  
MOSIADZ





Lock cylinder received „Test Certificate”  
issued by Instytut Techniki Budowlanej

Wkładka posiada „Świadectwo Badań”  
wystawione przez Instytut Techniki Budowlanej

COLOR BOX  
& MESH  
PLASTIC TRAY



| YATO  | L (mm) | mm    |  |
|--|--------|-------|---|
| YT-69900   | 62     | 31/31 | 12/60   |
| YT-69901   | 67     | 31/36 | 12/60   |
| YT-69902   | 72     | 31/41 | 12/60   |
| YT-69903   | 87     | 36/51 | 12/60   |

GB Lock cylinder  
D Schliesszylinder  
PL Wkładka do zamka  
RUS Замок цилиндрический  
CZ Vložka na zámek  
H Zárbetét  
RO Yală pt. broască  
F Serrure à encastrer  
I Cilindro con pomolo  
E Inserción de latón  
CN 锁芯

BRASS  
MOSIADZ

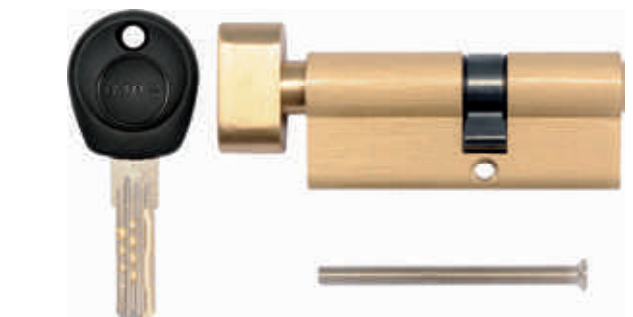



Lock cylinder received „Test Certificate”  
issued by Instytut Techniki Budowlanej

Wkładka posiada „Świadectwo Badań”  
wystawione przez Instytut Techniki Budowlanej

COLOR BOX  
& MESH  
PLASTIC TRAY



| YATO  | L (mm) | mm    |  |
|--|--------|-------|---|
| YT-69910   | 62     | 31/31 | 12/60   |
| YT-69911   | 67     | 31/36 | 12/60   |
| YT-69912   | 67     | 36/31 | 12/60   |
| YT-69913   | 72     | 31/41 | 12/60   |
| YT-69914   | 72     | 41/31 | 12/60   |

GB Lock cylinder  
D Schliesszylinder  
PL Wkładka do zamka  
RUS Замок цилиндрический  
CZ Vložka na zámek  
H Zárbetét  
RO Yală pt. broască  
F Serrure à encastrer  
I Cilindro con pomolo  
E Inserción de latón  
CN 锁芯

BRASS  
MOSIADZ

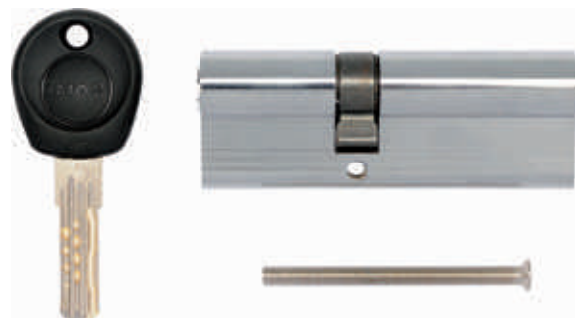



Lock cylinder received „Test Certificate”  
issued by Instytut Techniki Budowlanej

Wkładka posiada „Świadectwo Badań”  
wystawione przez Instytut Techniki Budowlanej

COLOR BOX  
& MESH  
PLASTIC TRAY



| YATO  | L (mm) | mm    |  |
|--|--------|-------|---|
| YT-69905   | 62     | 31/31 | 12/60   |
| YT-69906   | 67     | 31/36 | 12/60   |
| YT-69907   | 72     | 31/41 | 12/60   |
| YT-69908   | 87     | 36/51 | 12/60   |

GB Lock cylinder  
D Schliesszylinder  
PL Wkładka do zamka  
RUS Замок цилиндрический  
CZ Vložka na zámek  
H Zárbetét  
RO Yală pt. broască  
F Serrure à encastrer  
I Cilindro con pomolo  
E Inserción de latón  
CN 锁芯

BRASS  
MOSIADZ

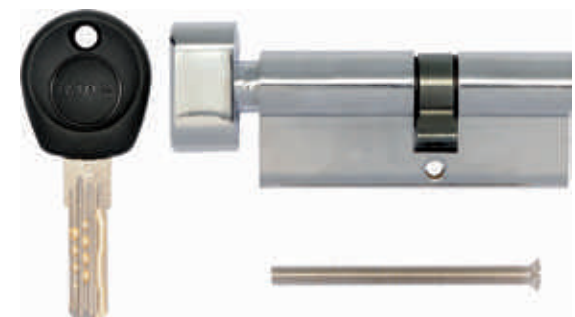



Lock cylinder received „Test Certificate”  
issued by Instytut Techniki Budowlanej

Wkładka posiada „Świadectwo Badań”  
wystawione przez Instytut Techniki Budowlanej

COLOR BOX  
& MESH  
PLASTIC TRAY



| YATO  | L (mm) | mm    |  |
|--|--------|-------|---|
| YT-69920   | 62     | 31/31 | 12/60   |
| YT-69921   | 67     | 31/36 | 12/60   |
| YT-69922   | 67     | 36/31 | 12/60   |
| YT-69923   | 72     | 31/41 | 12/60   |
| YT-69924   | 72     | 41/31 | 12/60   |

# 20

Accessories  
Akcesoria





Tool belts  
Pasy na narzędzia

416



Tool bags  
Torby narzędziowe

417



Tool pockets  
Kieszenie na narzędzia

416-417



- GB Heavy duty nail & tool pouch
- D Werkzeuggürtel mit Nagel- und Schraubentaschen
- PL Pas z kieszeniami na gwoździe i narzędzia
- RUS Ремень с сумками для гвоздей и инструментов
- CZ Pás na nářadí pětkapsový
- H Szeg és szerszámartató öv
- RO Centura port scule
- F Ceinture porte-outils clous
- I Cintura con le tasche per chiodi e utensili
- E Cinturón porta herramientas y accesorios varios
- CN 重型工具袋



**21**  
POCKETS  
KIESZENI

**120**  
cm

HEAVY  
DUTY  
NYLON

COLOR BOX



**COWHIDE BELT**



|             |    |
|-------------|----|
| <b>YATO</b> |    |
| YT-7400     | 10 |

- GB Pouch belt
- D Gürtel für Werkzeugtaschen
- PL Pas na kieszenie na narzędzia
- RUS Пояс для карманов для инструмента
- CZ Opasek na monterské kapsáře
- H Öv erszényhez
- RO Cureau cu buzunar
- F Ceinture porte-outils
- I Cintura con le tasche porta utensili
- E Cinturón para bolsas de herramientas
- CN 工具腰带



HEADER  
CARD



**90-120**  
cm

HEAVY  
DUTY  
NYLON

|             |        |
|-------------|--------|
| <b>YATO</b> |        |
| YT-7409     | 50/100 |

- GB 8-pocket tool bag
- D Gürtelwerkzeugtasche mit 8 Fächern
- PL 8. kieszeniowa torba na narzędzia
- RUS Сумка - 8 карманов для инструмента
- CZ Kapsář na nářadí 8-kapsový
- H Szerszámartató erszény, 8 zsebbel
- RO Geanta pt. scule 8 buzunare
- F Pochette à outils
- I Borsa porta attrezzi con 8 tasche
- E Bolso para herramientas de 8 bolsillos
- CN 工具包

HEADER  
CARD



**8**  
POCKETS  
KIESZENI

HEAVY  
DUTY  
NYLON

- GB Universal cordless drill holder
- D Gürteltasche für Akkuschauber
- PL Kieszeń na wiertarkę akumulatorową
- RUS Карман для аккумуляторной дрели
- CZ Kapsář za opasek na akuvrtáčku
- H Univerzális tartóerszény akkus csavabehajtóhoz

- RO Suport universal pt. bormasina
- F Pochette à perceuse sans fil
- I Fondina per trapano a batteria
- E Bolsa porta taladradora de acumulador
- CN 电钻通用挂袋

HEADER  
CARD



HEAVY  
DUTY  
NYLON



|             |       |
|-------------|-------|
| <b>YATO</b> |       |
| YT-7410     | 20/40 |

|             |       |
|-------------|-------|
| <b>YATO</b> |       |
| YT-7413     | 20/40 |

|             |       |
|-------------|-------|
| <b>YATO</b> |       |
| YT-7414     | 48/96 |

- GB Nail / tool pouch
- D Gürtelwerkzeugtasche
- PL Kieszeń na gwoździe i narzędzia
- RUS Карман для гвоздей и инструментов
- CZ Kapsář na nářadí
- H Szeg és szerszámartató erszény
- RO Buzunar pt. scule / cuie
- F Pochette à outils et clous
- I Tasche per chiodi e utensili
- E Bolsa porta herramientas y accesorios varios
- CN 钉子袋

HEADER  
CARD



HEAVY  
DUTY  
NYLON



|             |       |
|-------------|-------|
| <b>YATO</b> |       |
| YT-7416     | 20/40 |

|             |        |
|-------------|--------|
| <b>YATO</b> |        |
| YT-7417     | 39/156 |





- GB Nail pocket + hammer loop  
D Hammer und Nägel-Gürteltasche  
PL Kieszzeń z uchwytem na młotek  
RUS Карман-держатель для молотка  
CZ Kapsář za opasek na kladivo  
H Szeg tartó erszény kalapástartóval  
RO Suport pt. ciocan  
F Pochette à outils + porte-marteau  
I Tasca porta martello  
E Bolsa con el soporte para martillo  
CN 锤头钉子袋



HEAVY  
DUTY  
NYLON

HEADER  
CARD



**YATO**    
YT-7419 40/80



- GB Mobile phone pouch  
D Handy-Gürteltasche  
PL Kieszzeń na telefon komórkowy  
RUS Карман для мобильного телефона  
CZ Pouzdro za opasek na mobilni telefon  
H Mobil telefon tartó  
RO Suport pt. telefon  
F Pochette à téléphone portable  
I Tasca porta cellulare  
E Bolsa de teléfono móvil  
CN 手机袋



HEAVY  
DUTY  
NYLON

HEADER  
CARD



**YATO**    
YT-7420 27/54

- GB Tool bag  
D Werkzeugtasche  
PL Torba na narzędzia  
RUS Сумка для инструмента
- CZ Taška montérská  
H Szerszámos táská  
RO Geanta pt. scule  
F Sac à outils
- I Borsa per attrezzi  
E Bolso de herramientas  
CN 工具包



HEAVY  
DUTY  
NYLON



**16**  
POCKETS  
KIESZENI



**YATO**    
YT-7430 12

**YATO**    
YT-7433 12

- GB Steel tube tool carrier  
D Werkzeugkoffer  
PL Walizka narzędziowa  
RUS Семодан для инструмента  
CZ Taška na nářadí  
H Szerszámtartó csövázás  
RO Geanta de otel pt. portbagaj  
F Sac à outils  
I Valigetta per attrezzi  
E Maletín de herramientas  
CN 钢管柄工具包

**31**  
POCKETS  
KIESZENI

HEAVY  
DUTY  
NYLON



**YATO**    
YT-7435 4

- GB Foldable chair with bag  
D Werkzeugtasche mit Klappstuhl  
PL Torba narzędziowa z krzeselkiem  
RUS Стул складной с сумкой для инструмента  
CZ Taška na nářadí se stojánkem  
H Összecsukható szék tartózsebbel  
RO Scaun rabatabil cu geanta  
F Sac à outils + tabouret  
I Sedia pieghevole per borsa attrezzi  
E Bolso de herramientas con silla plegable  
CN 带包折叠椅

**22**  
POCKETS  
KIESZENI

HEAVY  
DUTY  
NYLON



**YATO**    
YT-7446 10

# 21

**Health & safety articles**  
**Artykuły BHP**





Safety glasses  
Okulary ochronne

420



Hearing protectors  
Nauszniki przeciwhałasowe

425



Safety goggles  
Gogle ochronne

421



Working shoes  
Buty robocze

426-427



Working gloves  
Rękawice robocze

421-422



Safety sandals

Sandały robocze..... 426

Low-cut safety shoes

Półbuty robocze..... 426

Middle-cut safety shoes

Trzewiki robocze..... 427

Knee pads  
Nakolanniki

422



Working clothes

Odzież robocza

428-429



Breathalyzers  
Alkomaty

422



Vests

Kamizelki..... 428

Working jackets

Bluzy i kurtki robocze..... 428

Working trousers

Spodnie robocze..... 429

Working overalls

Spodnie robocze ogrodniczki..... 429

Disposable dust masks  
Półmaski filtrujące

423-424



Ear plugs  
Zatyczki do uszu

424-425



GB Safety glasses  
D Schutzbrille  
PL Okulary ochronne

RUS Очки защитные открытые  
CZ Ochranné brýle  
H Védőszemüveg

RO Ochelari pt. protectie  
F Lunettes de protection  
I Occhiali protettivi

E Gafas protectoras  
CN 劳保眼镜



TYPE 90960 EN 166:2001 F

|   |   |
|---|---|
|  |  |
| YT-7360   | 12/240  |



TYPE 9844 EN 166:2001 F

|   |  |
|---|--|
|  |  |
| YT-7361   | 12/240   |



TYPE 91977 EN 166:2001 F

|   |   |
|---|---|
|  |  |
| YT-7363   | 12/240  |





TYPE 91659 EN 166:2001 F

|   |   |
|---|---|
|  |  |
| YT-7365   | 12/240  |



TYPE 91708 EN 166:2001 F

|   |  |
|---|--|
|  |  |
| YT-7367   | 12/240   |





TYPE 91797 EN 166:2001 F

|   |   |
|---|---|
|  |  |
| YT-7369   | 12/240  |





TYPE 91692 EN 166:2001 F

|   |   |
|---|---|
|  |  |
| YT-7371   | 12/240  |





TYPE B524 EN 166:2001 F

|   |  |
|---|--|
|  |  |
| YT-73631  | 12/300   |



TYPE B532 EN 166:2001 F

|   |   |
|---|---|
|  |  |
| YT-73761  | 12/300  |



TYPE 9844 EN 166:2001 F

|   |   |
|---|---|
|  |  |
| YT-7362   | 12/240  |



TYPE 91977 EN 166:2001 F

|   |  |
|---|--|
|  |  |
| YT-7364   | 12/240   |





TYPE 91659 EN 166:2001 F

|   |   |
|---|---|
|  |  |
| YT-7366   | 12/240  |





TYPE 91708 EN 166:2001 F

|   |   |
|---|---|
|  |  |
| YT-7368   | 12/240  |





TYPE 91293 EN 166:2001 F

|   |  |
|---|--|
|  |  |
| YT-7374   | 12/240   |



TYPE 91380 EN 166:2001 F

|   |   |
|---|---|
|  |  |
| YT-7376   | 12/240  |



TYPE B517 EN 166:2001 F

|   |   |
|---|---|
|  |  |
| YT-73641  | 12/300  |



TYPE B510 EN 166:2001 EN 169:2002

|   |  |
|---|--|
|  |  |
| YT-73744  | 12/300   |



TYPE B532 EN 166:2001 F

|   |   |
|---|---|
|  |  |
| YT-73760  | 12/300  |



GB Safety goggles  
D Schutzbrille  
PL Gogle ochronne  
RUS Очки защитные  
CZ Ochranné brýle

H Védőszemüveg  
RO Ochelari pt. protectie  
F Lunettes masque de protection

I Occhiali protettivi a mascherina  
E Gafas protectoras  
CN 劳保眼镜

PAPER HANGING CARD



TYPE 2876 EN 166:2001 F

|   |   |
|---|---|
|  |  |
| YT-7377   | 12/120  |



TYPE #2769 EN 166:2001 F

|   |   |
|---|---|
|  |  |
| YT-7380   | 20/200  |





TYPE SG90B EN 166:2001 F

|   |   |
|---|---|
|  |  |
| YT-7381   | 20/200  |



TYPE SG-60 EN 166:2001 B

|   |   |
|---|---|
|  |  |
| YT-7382   | 10/100  |





TYPE TW2015 EN 166:2001 B

|   |   |
|---|---|
|  |  |
| YT-7383   | 10/100  |



TYPE B608 EN 166:2001 B

|   |   |
|---|---|
|  |  |
| YT-73801  | 10/100  |





TYPE B421 EN 166:2001 B

|   |   |
|---|---|
|  |  |
| YT-73830  | 10/100  |

GB Working gloves  
D Arbeitshandschuh  
PL Rękawice robocze  
RUS Рабочие перчатки  
CZ Pracovní rukavice  
H Védőkesztyű  
RO Mănuși de lucru  
F Gants de travail  
I Guanti da lavoro  
E Guantes de piel  
CN 劳保手套





|   |                |   |
|---|----------------|---|
|  | size / rozmiar |  |
| YT-7470   | 10             | 50/100  |





PAPER HEADER





|   |                |   |
|---|----------------|---|
|  | size / rozmiar |  |
| YT-7472   | 10             | 50/100  |



|   |                |   |
|---|----------------|---|
|  | size / rozmiar |  |
| YT-7473   | 10             | 50/100  |



|   |                |   |
|---|----------------|---|
|  | size / rozmiar |  |
| YT-7474   | 10             | 50/100  |



GB Working gloves  
 D Arbeitshandschuh  
 PL Rękawice robocze  
 RUS Рабочие перчатки  
 CZ Pracovní rukavice  
 H Védőkesztyű  
 RO Mănuși de lucru  
 F Gants de travail  
 I Guanti da lavoro  
 E Guantes de piel  
 CN 劳保手套

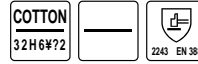

| YATO    | size / rozmiar |        |
|---------|----------------|--------|
| YT-7480 | 9              | 12/120 |
| YT-7481 | 10             | 12/120 |

| YATO    | size / rozmiar |        |
|---------|----------------|--------|
| YT-7471 | 10             | 12/120 |

GB Working gloves  
 D Arbeitshandschuh  
 PL Rękawice robocze

RUS Рабочие перчатки  
 CZ Pracovní rukavice  
 H Védőkesztyű

RO Mănuși de lucru  
 F Gants de travail  
 I Guanti da lavoro

E Guantes de piel  
 CN 劳保手套

PAPER HEADER



| YATO    | size / rozmiar |       |
|---------|----------------|-------|
| YT-7464 | 7 / L          | 12/48 |
| YT-7465 | 9 / XXL        | 12/48 |

| YATO    | size / rozmiar |       |
|---------|----------------|-------|
| YT-7467 | 9 / XXL        | 12/72 |

| YATO    | size / rozmiar |       |
|---------|----------------|-------|
| YT-7469 | 9 / XXL        | 12/48 |

GB Gel knee pads  
 D Gel Knieschoner  
 PL Nakolanniki żelowe  
 RUS Гелевые наколенники  
 CZ Nákolenníky gelové  
 H Térdvédő zselés  
 RO Genunchiere cu protectie de silicon

F Genouillères à coussinets de gel  
 I Protettore per ginocchio  
 E Protectores de gel para rodillas  
 CN 护膝



DISPLAY COLOR BOX



GEL SUPPORT



| YATO    |    |
|---------|----|
| YT-7460 | 12 |

| YATO    |    |
|---------|----|
| YT-7461 | 12 |

GB Disposable breathalyzer F Alcotest  
 D Alkoholtester I Etímetro  
 PL Alkomat jednorazowy monouso  
 RUS Алкотестер E Alcoholímetro  
 CZ Alkohol tester CN 酒精测试仪  
 H Alkoholszonda  
 RO Alcoolmetru



PLASTIC BAG

DISPLAY COLOR BOX

30 PCS



- results in 2 min
- accuracy 99%
- meets NF and TÜV standards
- user-friendly
- not includes carcinogenic potassium dichromate
- with two plastic mouthpieces

- test w 2 min
- dokładność 99%
- spełnia normy NF i TÜV
- prosty w obsłudze
- nie zawiera rakotwórczego dichromianu potasu
- z dwoma plastikowymi ustnikami

| YATO     |     |
|----------|-----|
| YT-73310 | 900 |



GB Disposable dust masks  
D Atemschutzmaske  
PL Półmiski filtrujące jednorazowe  
RUS Респиратор противопылевой  
одноразовый  
CZ Protiprašná maska  
H Eldobható porvédőmaszk  
RO Masca prař cu valva  
F Demi-masques de filtration  
I Maschera filtra polvere  
E Mascarilla desechable  
para protecci3n contra polvo  
CN 防尘面罩



**3**  
PCS

FFP1 NR



POLYBAG  
WITH HEADER



**YATO**    
YT-7485 25/100

GB Disposable dust masks with valve  
D Atemschutzmaske mit Ventil  
PL Półmiski filtrujące jednorazowe  
z zaworem  
RUS Респиратор противопылевой  
одноразовый с клапаном  
CZ Protiprašná maska s ventilem  
H Eldobható porvédőmaszk, szelepes  
RO Masca prař cu valva  
F Demi-masques de filtration  
I Maschera respiratoria con valvola  
di espirazione  
E Mascarilla desechable para  
protecci3n contra polvo  
CN 带阀防尘面罩



**3**  
PCS

FFP1 NR



POLYBAG  
WITH HEADER



**YATO**    
YT-7486 25/100

GB Disposable dust masks with valve  
D Atemschutzmaske mit Ventil  
PL Półmiski filtrujące jednorazowe  
z zaworem  
RUS Респиратор противопылевой  
одноразовый с клапаном  
CZ Protiprašná maska s ventilem  
H Eldobható porvédőmaszk, szelepes  
RO Masca prař cu valva  
F Demi-masques de filtration  
I Maschera respiratoria con valvola  
di espirazione  
E Mascarilla desechable para  
protecci3n contra polvo  
CN 带阀防尘面罩

**3**  
PCS

FFP1 NR



POLYBAG  
WITH HEADER



**YATO**    
YT-7488 25/100

GB Disposable dust masks with valve  
D Atemschutzmaske mit Ventil  
PL Półmiski filtrujące jednorazowe  
z zaworem  
RUS Респиратор противопылевой  
одноразовый с клапаном  
CZ Protiprašná maska s ventilem  
H Eldobható porvédőmaszk, szelepes  
RO Masca prař cu valva  
F Demi-masques de filtration  
I Maschera respiratoria con valvola  
di espirazione  
E Mascarilla desechable para  
protecci3n contra polvo  
CN 带阀防尘面罩

**500**  
PCS

FFP1 NR



POLYBAG  **500 PCS** WHITE CARTON BOX  
& COLOR LABEL

**YATO**    
YT-74947 1

GB Disposable dust masks with valve  
D Atemschutzmaske mit Ventil  
PL Półmiski filtrujące jednorazowe  
z zaworem  
RUS Респиратор противопылевой  
одноразовый с клапаном  
CZ Protiprašná maska s ventilem  
H Eldobható porvédőmaszk, szelepes  
RO Masca prař cu valva  
F Demi-masques de filtration  
I Maschera respiratoria con valvola  
di espirazione  
E Mascarilla desechable para  
protecci3n contra polvo  
CN 带阀防尘面罩

**500**  
PCS

FFP1 NR



POLYBAG  **500 PCS** WHITE CARTON BOX  
& COLOR LABEL

**YATO**    
YT-74951 1

GB Disposable dust masks with valve  
D Atemschutzmaske mit Ventil  
PL Półmiski filtrujące jednorazowe  
z zaworem  
RUS Респиратор противопылевой  
одноразовый с клапаном  
CZ Protiprašná maska s ventilem  
H Eldobható porvédőmaszk, szelepes  
RO Masca prař cu valva  
F Demi-masques de filtration  
I Maschera respiratoria con valvola  
di espirazione  
E Mascarilla desechable para  
protecci3n contra polvo  
CN 带阀防尘面罩

**3**  
PCS

FFP2 NR



POLYBAG  
WITH HEADER



**YATO**    
YT-7492 15/60

GB Disposable dust masks with valve  
 D Atemschutzmaske mit Ventil  
 PL Półmiski filtrujące jednorazowe z zaworem  
 RUS Респиратор противопылевой одноразовый с клапаном  
 CZ Protiprašná maska s ventilem  
 H Eldobható porvédőmaszk, szelepes  
 RO Mască praful cu valvă  
 F Demi-masques de filtration  
 I Maschera respiratoria con valvola di espirazione  
 E Mascarilla desechable para protección contra polvo  
 CN 带阀防尘面罩

**500**  
PCS

FFP2 NR



POLYBAG → **500 PCS** WHITE CARTON BOX & COLOR LABEL

|             |   |
|-------------|---|
| <b>YATO</b> |   |
| YT-74954    | 1 |

GB Disposable dust masks with valve  
 D Atemschutzmaske mit Ventil  
 PL Półmiski filtrujące jednorazowe z zaworem  
 RUS Респиратор противопылевой одноразовый с клапаном  
 CZ Protiprašná maska s ventilem  
 H Eldobható porvédőmaszk, szelepes  
 RO Mască praful cu valvă  
 F Demi-masques de filtration  
 I Maschera respiratoria con valvola di espirazione  
 E Mascarilla desechable para protección contra polvo  
 CN 带阀防尘面罩

**500**  
PCS

FFP2 NR



POLYBAG → **500 PCS** WHITE CARTON BOX & COLOR LABEL

|             |   |
|-------------|---|
| <b>YATO</b> |   |
| YT-74956    | 1 |

GB Disposable dust masks with valve  
 D Atemschutzmaske mit Ventil  
 PL Półmiski filtrujące jednorazowe z zaworem  
 RUS Респиратор противопылевой одноразовый с клапаном  
 CZ Protiprašná maska s ventilem  
 H Eldobható porvédőmaszk, szelepes  
 RO Mască praful cu valvă  
 F Demi-masques de filtration  
 I Maschera respiratoria con valvola di espirazione  
 E Mascarilla desechable para protección contra polvo  
 CN 带阀防尘面罩

**500**  
PCS

FFP3 NR



POLYBAG → **500 PCS** WHITE CARTON BOX & COLOR LABEL

|             |   |
|-------------|---|
| <b>YATO</b> |   |
| YT-74959    | 1 |

GB Ear plugs  
 D Gehörschutz  
 PL Zatycki do uszu

RUS Средства защиты слуха  
 CZ Chránice sluchu  
 H Fülvédőt

RO Antifoane  
 F Bouchons anti-bruit  
 I Tappi per orecchie

E Protectores de la vista  
 CN 耳塞



**SNR 34 dB**  
**5** PAIRS PAR

POLYBAG WITH HEADER

|             |                     |              |        |
|-------------|---------------------|--------------|--------|
| <b>YATO</b> | size / rozmiar (mm) | pairs / pary |        |
| YT-7451     | 7-12                | 5            | 25/500 |



**SNR 28 dB**  
**5** PAIRS PAR

POLYBAG WITH HEADER

|             |                     |              |        |
|-------------|---------------------|--------------|--------|
| <b>YATO</b> | size / rozmiar (mm) | pairs / pary |        |
| YT-7453     | 8-13                | 5            | 25/500 |



**SNR 22 dB**  
**5** PAIRS PAR

POLYBAG WITH HEADER

|             |                     |              |        |
|-------------|---------------------|--------------|--------|
| <b>YATO</b> | size / rozmiar (mm) | pairs / pary |        |
| YT-7455     | 8-12                | 5            | 25/500 |



POLYBAG WHITE CARTON BOX & COLOR LABEL

**SNR 33 dB**  
**100** PAIRS PAR



100 PCS



|             |                     |              |    |
|-------------|---------------------|--------------|----|
| <b>YATO</b> | size / rozmiar (mm) | pairs / pary |    |
| YT-7450     | 7-12                | 100          | 20 |



POLYBAG

WHITE CARTON BOX & COLOR LABEL

**SNR 28 dB**  
**100** PAIRS PAR



100 PCS



|             |                     |              |    |
|-------------|---------------------|--------------|----|
| <b>YATO</b> | size / rozmiar (mm) | pairs / pary |    |
| YT-7452     | 8-13                | 100          | 20 |



POLYBAG

WHITE CARTON BOX & COLOR LABEL

**SNR 22 dB**  
**50** PAIRS PAR



50 PCS



|             |                     |              |    |
|-------------|---------------------|--------------|----|
| <b>YATO</b> | size / rozmiar (mm) | pairs / pary |    |
| YT-7454     | 8-12                | 50           | 20 |



POLYBAG

DISPLAY COLOR BOX

**SNR 34 dB**  
**200** PAIRS PAR



200 PCS



|             |                     |              |    |
|-------------|---------------------|--------------|----|
| <b>YATO</b> | size / rozmiar (mm) | pairs / pary |    |
| YT-74510    | 7-12                | 200          | 20 |

GB Ear plugs  
 D Gehörschutz  
 PL Zatycki do uszu na sznurku

RUS Средства защиты слуха  
 CZ Chránice sluchu  
 H Fülvédőt  
 RO Antifoane

F Bouchons anti-bruit  
 I Tappi per orecchie  
 E Protectores de la vista  
 CN 耳塞

**SNR 28 dB**



POLYBAG

WHITE CARTON BOX & COLOR LABEL

**SNR 28 dB**  
**50** PAIRS PAR



50 PCS



|             |                     |              |    |
|-------------|---------------------|--------------|----|
| <b>YATO</b> | size / rozmiar (mm) | pairs / pary |    |
| YT-7456     | 8-10                | 50           | 20 |



- GB Ear plugs
- D Gehörschutz
- PL Zatyczki do uszu na pałąku
- RUS Средства защиты слуха
- CZ Chrániče sluchu
- H Fülvédőt
- RO Antifoane
- F Arceau antibruit avec bouchons
- I Tappi per orecchie auricolari
- E Protectores de la vista
- CN 耳塞



POLYBAG  
WITH  
HEADER





**SNR**  
21 dB



**SNR**  
26 dB

|   |   |
|---|---|
| <b>YATO</b>  |  |
| YT-7458   | 25/500  |

|   |   |
|---|---|
| <b>YATO</b>  |  |
| YT-7459   | 25/500  |

- GB Hearing protectors
- D Gehörschutz
- PL Nauszniki przeciwhałasowe
- RUS Средства защиты слуха
- CZ Chrániče sluchu
- H Fülvédőt
- RO Antifoane
- F Casque anti-bruit
- I Cuffie antirumore
- E Protectores de la vista
- CN 耳罩

POLYBAG  
WITH HEADER



**SNR**  
26 dB

|   |   |
|---|---|
| <b>YATO</b>  |  |
| YT-7462   | 40  |



**SNR**  
26 dB



**SNR**  
27 dB

|   |   |
|---|---|
| <b>YATO</b>  |  |
| YT-7463   | 20  |

|   |   |
|---|---|
| <b>YATO</b>  |  |
| YT-74621  | 60  |

GB Safety sandals  
D Arbeitshalschuhe  
PL Sandały robocze  
RUS Полуботинки рабочие

CZ Pracovní polobotky  
H Munkavédelmi félcipő  
RO Papuc de lucru  
F Sandale de sécurité

I Sandalo da lavoro  
E Zapato de trabajo  
CN 劳保鞋

RED CARTON BOX & COLOR LABEL



**SEGURA**

INSOLE & MESH COATED EVA  
WKŁADKA I WYŚCİÓŁKA Z MATERIAŁU EVA



COMPOSITE TOE CUP  
KOMPOZYTOWY NOSEK



SHOCK ABSORBER  
AMORTYZATOR DRGAŃ

PU OVERCUP  
PODESZWA Z POLIURETANU Z NOSKIEM

| YATO     | size / rozmiar |    |
|----------|----------------|----|
| YT-80460 | 36             | 10 |
| YT-80461 | 37             | 10 |
| YT-80462 | 38             | 10 |
| YT-80463 | 39             | 10 |
| YT-80464 | 40             | 10 |
| YT-80465 | 41             | 10 |
| YT-80466 | 42             | 10 |
| YT-80467 | 43             | 10 |
| YT-80468 | 44             | 10 |
| YT-80469 | 45             | 10 |
| YT-80470 | 46             | 10 |
| YT-80471 | 47             | 10 |

GB Low-cut safety shoes  
D Arbeitshalschuhe  
PL Półbuty robocze  
RUS Полуботинки рабочие

CZ Pracovní polobotky  
H Munkavédelmi félcipő  
RO Papuc de lucru  
F Chaussure de sécurité

I Scarpe da lavoro  
E Zapato de trabajo  
CN 劳保鞋

RED CARTON BOX & COLOR LABEL



**PUNO**

INSOLE & MESH COATED EVA  
WKŁADKA I WYŚCİÓŁKA Z MATERIAŁU EVA



STALOWY NOSEK  
STEEL TOE CAP  
PU SOLE  
PODESZWA Z POLIURETANU



SHOCK ABSORBER  
AMORTYZATOR DRGAŃ



INSOLE & MESH COATED EVA  
WKŁADKA I WYŚCİÓŁKA Z MATERIAŁU EVA



STALOWY NOSEK  
STEEL TOE CAP  
PU SOLE  
PODESZWA Z POLIURETANU



SHOCK ABSORBER  
AMORTYZATOR DRGAŃ



| YATO     | size / rozmiar |    |
|----------|----------------|----|
| YT-80521 | 39             | 10 |
| YT-80522 | 40             | 10 |
| YT-80523 | 41             | 10 |
| YT-80524 | 42             | 10 |
| YT-80525 | 43             | 10 |
| YT-80526 | 44             | 10 |
| YT-80527 | 45             | 10 |
| YT-80528 | 46             | 10 |
| YT-80529 | 47             | 10 |

| YATO     | size / rozmiar |    |
|----------|----------------|----|
| YT-80572 | 39             | 10 |
| YT-80573 | 40             | 10 |
| YT-80574 | 41             | 10 |
| YT-80575 | 42             | 10 |
| YT-80576 | 43             | 10 |
| YT-80577 | 44             | 10 |
| YT-80578 | 45             | 10 |
| YT-80579 | 46             | 10 |
| YT-80580 | 47             | 10 |

INSOLE & MESH COATED EVA  
WKŁADKA I WYŚCİÓŁKA Z MATERIAŁU EVA



STALOWY NOSEK  
STEEL TOE CAP  
PU SOLE  
PODESZWA Z POLIURETANU



SHOCK ABSORBER  
AMORTYZATOR DRGAŃ



INSOLE & MESH COATED EVA  
WKŁADKA I WYŚCİÓŁKA Z MATERIAŁU EVA



STALOWY NOSEK  
STEEL TOE CAP  
PU SOLE  
PODESZWA Z POLIURETANU



SHOCK ABSORBER  
AMORTYZATOR DRGAŃ



| YATO     | size / rozmiar |    |
|----------|----------------|----|
| YT-80552 | 39             | 10 |
| YT-80553 | 40             | 10 |
| YT-80554 | 41             | 10 |
| YT-80555 | 42             | 10 |
| YT-80556 | 43             | 10 |
| YT-80557 | 44             | 10 |
| YT-80558 | 45             | 10 |
| YT-80559 | 46             | 10 |
| YT-80560 | 47             | 10 |

| YATO     | size / rozmiar |    |
|----------|----------------|----|
| YT-80583 | 39             | 10 |
| YT-80584 | 40             | 10 |
| YT-80585 | 41             | 10 |
| YT-80586 | 42             | 10 |
| YT-80587 | 43             | 10 |
| YT-80588 | 44             | 10 |
| YT-80589 | 45             | 10 |
| YT-80590 | 46             | 10 |
| YT-80591 | 47             | 10 |



GB Middle-cut safety shoes  
D Arbeitsschnurschuhe  
PL Trzewiki robocze  
RUS Ботинки рабочие

CZ Pracovní boty šněrovací  
H Munkavédelmi bakancs  
RO Pantof de lucru  
F Chaussure de sécurité

I Scarpe da lavoro  
E Calzado de trabajo  
CN 劳保鞋

RED CARTON BOX  
& COLOR LABEL



INSOLE & MESH  
COATED EVA

WKŁADKA  
I WYSIÓŁKA  
Z MATERIAŁU  
EVA



SHOCK ABSORBER  
AMORTYZATOR  
DRGAŃ



## TRAT

STEEL TOE CAP  
STALOWY NOSEK

PU SOLE  
PODESZWA  
Z POLIURETANU



INSOLE & MESH  
COATED EVA

WKŁADKA  
I WYSIÓŁKA  
Z MATERIAŁU  
EVA



SHOCK ABSORBER  
AMORTYZATOR  
DRGAŃ



## TABAR

STEEL TOE CAP  
STALOWY NOSEK

PU SOLE  
PODESZWA  
Z POLIURETANU



| YATO     | size / rozmiar |    |
|----------|----------------|----|
| YT-80733 | 39             | 10 |
| YT-80734 | 40             | 10 |
| YT-80735 | 41             | 10 |
| YT-80736 | 42             | 10 |
| YT-80737 | 43             | 10 |
| YT-80738 | 44             | 10 |
| YT-80739 | 45             | 10 |
| YT-80740 | 46             | 10 |
| YT-80741 | 47             | 10 |

| YATO     | size / rozmiar |    |
|----------|----------------|----|
| YT-80761 | 39             | 10 |
| YT-80762 | 40             | 10 |
| YT-80763 | 41             | 10 |
| YT-80764 | 42             | 10 |
| YT-80765 | 43             | 10 |
| YT-80766 | 44             | 10 |
| YT-80767 | 45             | 10 |
| YT-80768 | 46             | 10 |
| YT-80769 | 47             | 10 |

INSOLE & MESH  
COATED EVA

WKŁADKA  
I WYSIÓŁKA  
Z MATERIAŁU  
EVA



SHOCK ABSORBER  
AMORTYZATOR  
DRGAŃ



## TENDA

STEEL TOE CAP  
STALOWY NOSEK

PU OVERCUP  
PODESZWA  
Z POLIURETANU  
Z NOSKIEM

PU SOLE  
PODESZWA  
Z POLIURETANU



INSOLE & MESH  
COATED EVA

WKŁADKA  
I WYSIÓŁKA  
Z MATERIAŁU  
EVA



SHOCK ABSORBER  
AMORTYZATOR  
DRGAŃ



## TEZU

STEEL TOE CAP  
STALOWY NOSEK

PU SOLE  
PODESZWA  
Z POLIURETANU



| YATO     | size / rozmiar |    |
|----------|----------------|----|
| YT-80852 | 39             | 10 |
| YT-80853 | 40             | 10 |
| YT-80854 | 41             | 10 |
| YT-80855 | 42             | 10 |
| YT-80856 | 43             | 10 |
| YT-80857 | 44             | 10 |
| YT-80858 | 45             | 10 |
| YT-80859 | 46             | 10 |
| YT-80860 | 47             | 10 |

| YATO     | size / rozmiar |    |
|----------|----------------|----|
| YT-80841 | 39             | 10 |
| YT-80842 | 40             | 10 |
| YT-80843 | 41             | 10 |
| YT-80844 | 42             | 10 |
| YT-80845 | 43             | 10 |
| YT-80846 | 44             | 10 |
| YT-80847 | 45             | 10 |
| YT-80848 | 46             | 10 |
| YT-80849 | 47             | 10 |

INSOLE & MESH  
COATED EVA

WKŁADKA  
I WYSIÓŁKA  
Z MATERIAŁU  
EVA



SHOCK ABSORBER  
AMORTYZATOR  
DRGAŃ



## TOLU

STEEL TOE CAP  
STALOWY NOSEK

PU SOLE  
PODESZWA  
Z POLIURETANU



INSOLE & MESH  
COATED EVA

WKŁADKA  
I WYSIÓŁKA  
Z MATERIAŁU  
EVA



SHOCK ABSORBER  
AMORTYZATOR  
DRGAŃ



## TWER

STEEL TOE CAP  
STALOWY NOSEK

PU SOLE  
PODESZWA  
Z POLIURETANU



| YATO     | size / rozmiar |    |
|----------|----------------|----|
| YT-80794 | 39             | 10 |
| YT-80795 | 40             | 10 |
| YT-80796 | 41             | 10 |
| YT-80797 | 42             | 10 |
| YT-80798 | 43             | 10 |
| YT-80799 | 44             | 10 |
| YT-80800 | 45             | 10 |
| YT-80801 | 46             | 10 |
| YT-80802 | 47             | 10 |

| YATO     | size / rozmiar |    |
|----------|----------------|----|
| YT-80783 | 39             | 10 |
| YT-80784 | 40             | 10 |
| YT-80785 | 41             | 10 |
| YT-80786 | 42             | 10 |
| YT-80787 | 43             | 10 |
| YT-80788 | 44             | 10 |
| YT-80789 | 45             | 10 |
| YT-80790 | 46             | 10 |
| YT-80791 | 47             | 10 |

- GB Insulated vest
- D Gepolsterte Weste
- PL Bezrękawnik ocieplany
- RUS Утепленный жилет
- CZ Vesta
- H Bélelt mellény
- RO Vestă vătuită
- F Gilet matelassé
- I Gilet imbottito
- E Chaleco acolchado
- CN 绝缘背心



100% POLYESTER  
PVC COATED  
100% POLYESTER  
POWLOKA PVC

POLYBAG



## DUGO

| YATO     | size / rozmiar |    |
|----------|----------------|----|
| YT-80355 | S              | 20 |
| YT-80356 | M              | 20 |
| YT-80357 | L              | 20 |
| YT-80358 | XL             | 20 |
| YT-80359 | XXL            | 20 |

- GB Fleece jacket
- D Fleece-Jacke
- PL Bluza polarowa
- RUS Флисовая кофта
- CZ Fleecová bunda
- H Fleece dzseki
- RO Bluză polar
- F Veste polaire
- I Giacca in pile
- E Chaqueta polar
- CN 摇粒绒夹克



POLAR  
350g/m<sup>2</sup>

POLYBAG



## DURANGO BLACK

| YATO     | size / rozmiar |   |
|----------|----------------|---|
| YT-80360 | S              | 8 |
| YT-80361 | M              | 8 |
| YT-80362 | L              | 8 |
| YT-80363 | XL             | 8 |
| YT-80364 | XXL            | 8 |

- GB Fleece jacket
- D Fleece-Jacke
- PL Bluza polarowa
- RUS Флисовая кофта
- CZ Fleecová bunda
- H Fleece dzseki
- RO Bluză polar
- F Veste polaire
- I Giacca in pile
- E Chaqueta polar
- CN 摇粒绒夹克



POLAR  
350g/m<sup>2</sup>

POLYBAG



## DURANGO GREY

| YATO     | size / rozmiar |   |
|----------|----------------|---|
| YT-80365 | S              | 8 |
| YT-80366 | M              | 8 |
| YT-80367 | L              | 8 |
| YT-80368 | XL             | 8 |
| YT-80369 | XXL            | 8 |

- GB Softshell jacket
- D Softshell-Jacke
- PL Kurtka softshell
- RUS Softshell куртка
- CZ Softshellová bunda
- H Softshell dzseki
- RO Jacheta softshell
- F Veste softshell
- I Giacca softshell
- E Chaqueta softshell
- CN 冲锋夹克



98% POLYESTER  
4% SPANDEX  
98% POLYESTER  
4% SPANDEX

POLYBAG



## DEZ

| YATO     | size / rozmiar |    |
|----------|----------------|----|
| YT-80390 | S              | 10 |
| YT-80391 | M              | 10 |
| YT-80392 | L              | 10 |
| YT-80393 | XL             | 10 |
| YT-80394 | XXL            | 10 |

- GB Jacket
- D Jacke
- PL Kurtka
- RUS Куртка
- CZ Bunda
- H Dzseki
- RO Jacheta
- F Veste
- I Giacca
- E Chaqueta
- CN 夹克

100% POLYESTER  
PVC COATED  
100% POLYESTER  
POWLOKA PVC

POLAR  
220g/m<sup>2</sup>  
**3in1**  
**3w1**

POLYBAG



## DORRA

| YATO     | size / rozmiar |    |
|----------|----------------|----|
| YT-80380 | S              | 10 |
| YT-80381 | M              | 10 |
| YT-80382 | L              | 10 |
| YT-80383 | XL             | 10 |
| YT-80384 | XXL            | 10 |

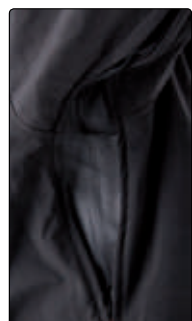



- GB Working jacket
- D Arbeitsjacke
- PL Bluzka robocza
- RUS Рабочая рубашка
- CZ Pracovní blůza
- H Munkaruha felső
- RO Bluză de lucru
- F Blouson de travail
- I Felpa da lavoro
- E Blusa de trabajo
- CN 工作服





65% POLYESTER  
35% COTTON  
65% POLYESTER  
35% BAWELNA

POLYBAG



## DUERO

| YATO  | size / rozmiar |  |
|--|----------------|---|
| YT-8020  | S              | 20  |
| YT-8021  | M              | 20  |
| YT-8022  | L              | 20  |
| YT-8023  | XL             | 20  |
| YT-8024  | XXL            | 20  |

- GB Working trousers
- D Arbeitshosen
- PL Spodnie robocze
- RUS Рабочие брюки
- CZ Pracovní kalhoty
- H Munkaruha nadrág
- RO Pantaloni de lucru
- F Pantalon de travail
- I Pantalone da lavoro
- E Pantalón de trabajo
- CN 工作服



65% POLYESTER  
35% COTTON  
65% POLYESTER  
35% BAWELNA

POLYBAG



## DUERO

| YATO  | size / rozmiar |  |
|--|----------------|---|
| YT-8025  | S              | 20  |
| YT-8026  | M              | 20  |
| YT-8027  | L              | 20  |
| YT-8028  | XL             | 20  |
| YT-8029  | XXL            | 20  |

- GB Working overalls
- D Arbeitshosen, Gärtnerin
- PL Spodnie robocze ogrodniczki
- RUS Рабочий полукombineзон
- CZ Pracovní kalhoty lačlové
- H Kertész nadrág
- RO Pantaloni de lucru grădină
- F Salopette de travail
- I Salopette da lavoro
- E Pantalón de trabajo tipo jardinero
- CN 工作服





65% POLYESTER  
35% COTTON  
65% POLYESTER  
35% BAWELNA

POLYBAG



## DUERO

| YATO  | size / rozmiar |  |
|--|----------------|---|
| YT-8030  | S              | 20  |
| YT-8031  | M              | 20  |
| YT-8032  | L              | 20  |
| YT-8033  | XL             | 20  |
| YT-8034  | XXL            | 20  |

# 22

## Electric products Artykuły elektryczne





LED bulbs  
Żarówki LED

432



LED workshop lightning  
Oświetlenie warsztatowe LED

435-437



LED lamps  
Reflektory LED

433-434



Extension cords  
Przedłużacze elektryczne

438-439



GB LED light bulb  
 D LED- Glühlampe  
 PL Żarówka LED  
 RUS Светодиодная лампочка  
 CZ LED žárovka  
 H LED égő  
 RO Bec LED  
 F Ampoule LED  
 I Lampadina LED  
 E Bombilla LED  
 CN LED灯泡

E27

**7W** **10W** **12W**

**590 lm** **720 lm** **950 W**

REPLACEMENT / ODPowiednik

40W 60W 75W

WHITE WARM BIAŁY CIEPŁY

**3000K CRI>80** **230V~ 50Hz**

**LED**



PVC COLOR BOX

| YATO     | W  | lm  | replacement / odpowiednik (W) |        |
|----------|----|-----|-------------------------------|--------|
| YT-81851 | 7  | 590 | 40                            | 50/100 |
| YT-81852 | 10 | 720 | 60                            | 50/100 |
| YT-81853 | 12 | 950 | 75                            | 50/100 |

GB LED light bulb  
 D LED- Glühlampe  
 PL Żarówka LED  
 RUS Светодиодная лампочка  
 CZ LED žárovka  
 H LED égő  
 RO Bec LED  
 F Ampoule LED  
 I Lampadina LED  
 E Bombilla LED  
 CN LED灯泡

GU10

**5W** **250 lm**

REPLACEMENT / ODPowiednik

25W 3000K CRI>80

WHITE WARM BIAŁY CIEPŁY

**230V~ 50Hz**

**LED**



PVC COLOR BOX

| YATO     | W | lm  | replacement / odpowiednik (W) |        |
|----------|---|-----|-------------------------------|--------|
| YT-81861 | 5 | 250 | 25                            | 50/200 |

GB LED light bulb  
 D LED- Glühlampe  
 PL Żarówka LED  
 RUS Светодиодная лампочка  
 CZ LED žárovka  
 H LED égő  
 RO Bec LED  
 F Ampoule LED  
 I Lampadina LED  
 E Bombilla LED  
 CN LED灯泡

MR16UV

**5W** **265 lm**

REPLACEMENT / ODPowiednik

25W 3000K CRI>80

WHITE WARM BIAŁY CIEPŁY

**12V AC/DC**

**LED**



PVC COLOR BOX

| YATO     | W | lm  | replacement / odpowiednik (W) |        |
|----------|---|-----|-------------------------------|--------|
| YT-81862 | 5 | 265 | 25                            | 50/200 |

GB LED light bulb  
 D LED- Glühlampe  
 PL Żarówka LED  
 RUS Светодиодная лампочка  
 CZ LED žárovka  
 H LED égő  
 RO Bec LED  
 F Ampoule LED  
 I Lampadina LED  
 E Bombilla LED  
 CN LED灯泡

E14

**3W** **160 lm**

REPLACEMENT / ODPowiednik

20W 3000K CRI>80

WHITE WARM BIAŁY CIEPŁY

**230V~ 50Hz**

**LED**



PVC COLOR BOX

| YATO     | W | lm  | replacement / odpowiednik (W) |        |
|----------|---|-----|-------------------------------|--------|
| YT-81871 | 3 | 160 | 20                            | 50/100 |



GB LED lamp  
D Diodescheinwerfer  
PL Reflektor diodowy  
RUS Светодиодный прожектор  
CZ LED reflektor  
H Diódás reflektor  
RO Reflector diodă  
F Projecteur LED  
I Faretto LED  
E Reflector de diodos  
CN 工作灯

10W 6000°K ~220-240V 50Hz  
700 lm 20000 h IP65

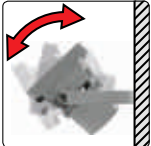
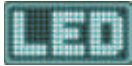

**YATO**  
YT-81800 18

GB LED lamp with motion detector  
D Diodescheinwerfer mit Bewegungsmelder  
PL Reflektor diodowy z czujnikiem ruchu  
RUS Светодиодный прожектор с датчиком движения  
CZ LED reflektor se snímačem pohybu  
H Diódás reflektor mozgásérzékelővel  
RO Reflector diodă cu senzor de mișcare  
F Projecteur LED avec détecteur de mouvement  
I Faretto LED con sensore movimento  
E Reflector de diodos con sensor de movimiento  
CN 工作灯

10W 6000°K ~220-240V 50Hz  
700 lm 20000 h IP44

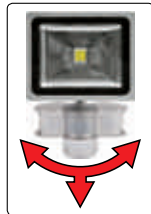

**YATO**  
YT-81801 18

GB Portable LED lamp  
D Diodescheinwerfer, mit Tragebügel  
PL Reflektor diodowy przenośny  
RUS Светодиодный прожектор переносной  
CZ LED reflektor přenosný  
H Hordozható, diódás reflektor  
RO Reflector diodă portabil  
F Projecteur LED  
I Faretto LED portatile  
E Reflector de diodos portátil  
CN 手提式工作灯

10W 6000°K ~220-240V 50Hz  
700 lm 20000 h IP65

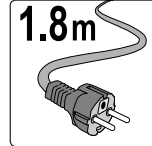
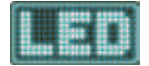

**YATO**  
YT-81802 12

GB LED lamp  
D Diodescheinwerfer  
PL Reflektor diodowy  
RUS Светодиодный прожектор  
CZ LED reflektor  
H Diódás reflektor  
RO Reflector diodă  
F Projecteur LED  
I Faretto LED  
E Reflector de diodos  
CN 工作灯

30W 6000°K ~220-240V 50Hz  
2100 lm 20000 h IP65

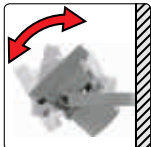
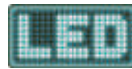

**YATO**  
YT-81803 6

GB LED lamp with motion detector  
D Diodescheinwerfer mit Bewegungsmelder  
PL Reflektor diodowy z czujnikiem ruchu  
RUS Светодиодный прожектор с датчиком движения  
CZ LED reflektor se snímačem pohybu  
H Diódás reflektor mozgásérzékelővel  
RO Reflector diodă cu senzor de mișcare  
F Projecteur LED avec détecteur de mouvement  
I Faretto LED con sensore movimento  
E Reflector de diodos con sensor de movimiento  
CN 工作灯

30W 6000°K ~220-240V 50Hz  
2100 lm 20000 h IP44

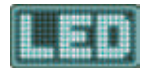

**YATO**  
YT-81804 6

GB Portable handle for LED floodlight  
D Tragbare Ständer für LED-Lampen  
PL Uchwyt do reflektora LED  
RUS Портативная подставка для светодиодных ламп  
CZ Přenosný stojan LED světlometů  
H Hordozható állvány LED fényszóró  
RO Suport portabil faruri cu LED-uri  
F Poignée pour projecteur LED  
I Supporto portatile per faretto LED  
E Soporte portátil linterna LED  
CN 灯手柄

for / dla: YT-81803



WHITE CARTON BOX & COLOR LABEL

**YATO**  
YT-81805 8

GB LED lamp  
D Diodescheinwerfer  
PL Reflektor diodowy  
RUS Светодиодный прожектор  
CZ LED reflektor  
H Diódás reflektor  
RO Reflector diodă  
F Projecteur LED  
I Faretto LED  
E Reflector de diodos  
CN 工作灯

50W 3500 lm 6000°K ~220-240V 50Hz  
20000 h IP65

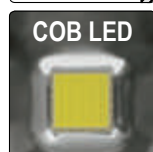
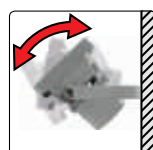
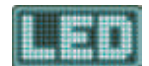

**YATO**  
YT-81806 3



- GB LED lamp
- D Diodenscheinwerfer
- PL Reflektor diodowy
- RUS Светодиодный прожектор
- CZ LED reflektor
- H Diódás reflektor
- RO Reflector diodă
- F Projecteur LED
- I Faretto LED
- E Reflector de diodos
- CN 工作灯

COLOR BOX



|                               |                     |
|-------------------------------|---------------------|
| <b>6W</b>                     | <b>6 LED</b>        |
| ~220-240V<br>50Hz             | <b>510<br/>lm</b>   |
| HIGH POWER LED                | 30 000-<br>50 000 h |
| <b>1W</b><br>DIODA DUŻEJ MOCY | <b>IP54</b>         |

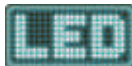

LOW ENERGY CONSUMPTION  
  
NISKIE ZUŻYCIE ENERGII

**YATO**   
YT-81790 24

- GB LED lamp with motion detector
- D Diodenscheinwerfer mit Bewegungsmelder
- PL Reflektor diodowy z czujnikiem ruchu
- RUS Светодиодный прожектор с датчиком движения
- CZ LED reflektor se snímačem pohybu
- H Diódás reflektor mozgásérzékelővel
- RO Reflector diodă cu senzor de mișcare
- F Projecteur LED avec détecteur de mouvement
- I Faretto LED con sensore movimento
- E Reflector de diodos con sensor de movimiento
- CN 工作灯

COLOR BOX



|                               |                     |
|-------------------------------|---------------------|
| <b>6W</b>                     | <b>6 LED</b>        |
| ~220-240V<br>50Hz             | <b>510<br/>lm</b>   |
| HIGH POWER LED                | 30 000-<br>50 000 h |
| <b>1W</b><br>DIODA DUŻEJ MOCY | <b>IP44</b>         |

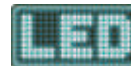

LOW ENERGY CONSUMPTION  
  
NISKIE ZUŻYCIE ENERGII

MOTION DETECTOR  
  
CZUJNIK RUCHU

**YATO**   
YT-81791 18

- GB Portable LED lamp
- D Diodenscheinwerfer, mit Tragebügel
- PL Reflektor diodowy przenośny
- RUS Светодиодный прожектор переносной
- CZ LED reflektor přenosný
- H Hordozható, diódás reflektor
- RO Reflector diodă portabil
- F Projecteur LED
- I Faretto LED portatilea
- E Reflector de diodos portátil
- CN 手提式工作灯

COLOR BOX



|                               |                     |
|-------------------------------|---------------------|
| <b>6W</b>                     | <b>6 LED</b>        |
| ~220-240V<br>50Hz             | <b>510<br/>lm</b>   |
| HIGH POWER LED                | 30 000-<br>50 000 h |
| <b>1W</b><br>DIODA DUŻEJ MOCY | <b>IP54</b>         |



LOW ENERGY CONSUMPTION  
  
NISKIE ZUŻYCIE ENERGII

**YATO**   
YT-81792 12

- GB LED lamp
- D Diodenscheinwerfer
- PL Reflektor diodowy
- RUS Светодиодный прожектор
- CZ LED reflektor
- H Diódás reflektor
- RO Reflector diodă
- F Projecteur LED
- I Faretto LED
- E Reflector de diodos
- CN 工作灯

COLOR BOX



|                               |                     |
|-------------------------------|---------------------|
| <b>12W</b>                    | <b>12 LED</b>       |
| ~220-240V<br>50Hz             | <b>1020<br/>lm</b>  |
| HIGH POWER LED                | 30 000-<br>50 000 h |
| <b>1W</b><br>DIODA DUŻEJ MOCY | <b>IP54</b>         |

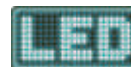

LOW ENERGY CONSUMPTION  
  
NISKIE ZUŻYCIE ENERGII

**YATO**   
YT-81793 16

- GB LED lamp with motion detector
- D Diodenscheinwerfer mit Bewegungsmelder
- PL Reflektor diodowy z czujnikiem ruchu
- RUS Светодиодный прожектор с датчиком движения
- CZ LED reflektor se snímačem pohybu
- H Hordozható, diódás reflektor mozgásérzékelővel
- RO Reflector diodă cu senzor de mișcare
- F Projecteur LED avec détecteur de mouvement
- I Faretto LED con sensore movimento
- E Reflector de diodos con sensor de movimiento
- CN 工作灯

COLOR BOX



|                               |                     |
|-------------------------------|---------------------|
| <b>12W</b>                    | <b>12 LED</b>       |
| ~220-240V<br>50Hz             | <b>1020<br/>lm</b>  |
| HIGH POWER LED                | 30 000-<br>50 000 h |
| <b>1W</b><br>DIODA DUŻEJ MOCY | <b>IP44</b>         |

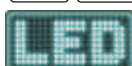

LOW ENERGY CONSUMPTION  
  
NISKIE ZUŻYCIE ENERGII

MOTION DETECTOR  
  
CZUJNIK RUCHU

**YATO**   
YT-81794 12

- GB Portable LED lamp
- D Diodenscheinwerfer, mit Tragebügel
- PL Reflektor diodowy przenośny
- RUS Светодиодный прожектор переносной
- CZ LED reflektor přenosný
- H Hordozható, diódás reflektor
- RO Reflector diodă portabil
- F Projecteur LED
- I Faretto LED portatilea
- E Reflector de diodos portátil
- CN 手提式工作灯

COLOR BOX



|                               |                     |
|-------------------------------|---------------------|
| <b>12W</b>                    | <b>12 LED</b>       |
| ~220-240V<br>50Hz             | <b>1020<br/>lm</b>  |
| HIGH POWER LED                | 30 000-<br>50 000 h |
| <b>1W</b><br>DIODA DUŻEJ MOCY | <b>IP54</b>         |

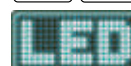

LOW ENERGY CONSUMPTION  
  
NISKIE ZUŻYCIE ENERGII

**YATO**   
YT-81795 8



GB Workshop LED battery lamp  
D LED Akku-handleuchte  
PL Diodowa lampa warsztatowa akumulatorowa  
RUS Аккумуляторный светодиодный светильник для мастерской  
CZ Ruční svítidla LED  
H Ledes szerelőlámpa címkéjű cikkek  
RO Lampa portabila cu acumulator leduri  
F Lampe baladeuse  
I Lampada per officina spaccata  
E Linterna LED recargable  
CN 可充式LED灯



**YATO**  
YT-08502 12

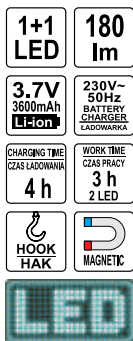

GB Workshop LED battery lamp  
D LED Akku-handleuchte  
PL Diodowa lampa warsztatowa akumulatorowa  
RUS Аккумуляторный светодиодный светильник для мастерской  
CZ Ruční svítidla LED  
H Ledes szerelőlámpa címkéjű cikkek  
RO Lampa portabila cu acumulator leduri  
F Lampe néon  
I Lampada neon  
E Linterna LED recargable  
CN 可充式LED灯



**YATO**  
YT-08561 20



GB Workshop LED battery lamp  
D LED Akku-handleuchte  
PL Diodowa lampa warsztatowa akumulatorowa  
RUS Аккумуляторный светодиодный светильник для мастерской  
CZ Ruční svítidla LED  
H Ledes szerelőlámpa címkéjű cikkek  
RO Lampa portabila cu acumulator leduri  
F Lampe d'inspection  
I Torcia ispezione  
E Linterna LED recargable  
CN 可充式LED灯



**YATO**  
YT-08514 12/72

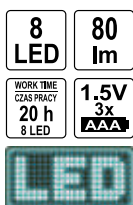

GB Workshop LED battery lamp  
D LED Akku-handleuchte  
PL Diodowa lampa warsztatowa akumulatorowa  
RUS Аккумуляторный светодиодный светильник для мастерской  
CZ Ruční svítidla LED  
H Ledes szerelőlámpa címkéjű cikkek  
RO Lampa portabila cu acumulator leduri  
F Lampe baladeuse  
I Lampada per officina spaccata  
E Linterna LED recargable  
CN 可充式LED灯



**YATO**  
YT-08513 50

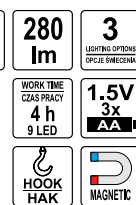



GB Workshop LED battery lamp  
 D LED Akku-handleuchte  
 PL Diodowa lampa warsztatowa akumulatorowa  
 RUS Аккумуляторный светодиодный светильник для мастерской  
 CZ Ruční svítlna LED  
 H Ledes szerezőlámpa címkéjű cikkek  
 RO Lampa portabila cu acumulator leduri  
 F Lampe baladeuse  
 I Lampada led per autofficina  
 E Linterna LED recargable  
 CN 可充長款鉗腳

27 LED 13000 MCD 3.6V 1200mAh Ni-MH

230V~50Hz BATTERY CHARGER LADOWARKA WATER PROOF ODPORNA NA WODĘ

CHARGING TIME CZAS ŁADOWANIA 4 h 4 h

HOOK HAK MAGNETIC

LED



**YATO** YT-08523 10



GB Workshop LED battery lamp  
 D LED Akku-handleuchte  
 PL Diodowa lampa warsztatowa akumulatorowa  
 RUS Аккумуляторный светодиодный светильник для мастерской  
 CZ Ruční svítlna LED  
 H Ledes szerezőlámpa címkéjű cikkek  
 RO Lampa portabila cu acumulator leduri  
 F Lampe baladeuse  
 I Lampada per officina spaccata  
 E Linterna LED recargable  
 CN 可充長款鉗腳

30/7 LED 13000 MCD 3.6V 1200mAh Ni-MH

230V~50Hz BATTERY CHARGER LADOWARKA CHARGING TIME CZAS ŁADOWANIA 4-5 h

15 h (7 LED) 4 h (30 LED)

HOOK HAK MAGNETIC

LED



**YATO** YT-08505 10



GB Rechargeable work lamp  
 D Led Werkstattlampe  
 PL Diodowa lampa warsztatowa  
 RUS Светодиодная беспроводная лампа  
 CZ Montážní lampa diodová bezpřívodová  
 H Ledlámpa  
 RO Lampa cu led fara cablu  
 F Lampe baladeuse  
 I Lampada led per autofficina  
 E Lámpara inalámbrica de diodos  
 CN 可充电工作灯

4 LED 400 lm IP65

WIRE PRZEWÓD 4.9 m HOOK HAK

LED



**YATO** YT-08531 10



GB Rechargeable work lamp  
 D Led Werkstattlampe  
 PL Diodowa lampa warsztatowa  
 RUS Светодиодная беспроводная лампа  
 CZ Montážní lampa diodová bezpřívodová  
 H Ledlámpa  
 RO Lampa cu led fara cablu  
 F Lampe baladeuse  
 I Lampada led per autofficina  
 E Lámpara inalámbrica de diodos  
 CN 可充电工作灯

60+1 LED 13000 MCD 7.2V 800mAh Ni-MH

230V~50Hz BATTERY CHARGER LADOWARKA WATER PROOF ODPORNA NA WODĘ

4 h

HOOK HAK MAGNETIC

LED



**YATO** YT-0852 5/20





- |  |  |
|--|--|
| GB Under bonnet work led lamp                              | H Ledlámpa   |
| D Led Werkstattlampe                                       | RO Lampa cu led fara cablu                                   |
| PL Diodowa lampa warsztatowa do oświetlenia komory silnika | F Rampe d'éclairage  |
| RUS Светодиодная беспроводная лампа                        | I Lampada led trasportabile per illuminazione di vani motore |
| CZ Montážní lampa diodová bezpřívodová                     | E Lámpara inalámbrica de diodos                              |
|  | CN 引擎盖检修灯  |

|   |   |  |
|---|---|--|
| <b>100 LED</b>                                    | <b>600 lm</b>                                   | <b>7.4V</b><br>2000mAh<br>Li-Ion                 |
| 230V~<br>50Hz<br>BATTERY<br>CHARGER<br>LADOWNARKA | CHARGING TIME<br>CZAS ŁADOWANIA<br><b>3-4 h</b> | WORK TIME<br>CZAS PRACY<br><b>4 h</b><br>100 LED |
|   | <b>HOOK<br/>HAK</b>                             |  |
| <b>LED</b>  |   |  |

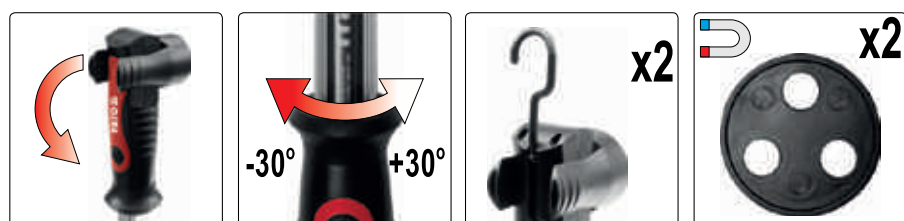

- |  |  |
|--|--|
| GB Under bonnet work led lamp                              | H Ledlámpa   |
| D Led Werkstattlampe                                       | RO Lampa cu led fara cablu                                   |
| PL Diodowa lampa warsztatowa do oświetlenia komory silnika | F Rampe d'éclairage  |
| RUS Светодиодная беспроводная лампа                        | I Lampada led trasportabile per illuminazione di vani motore |
| CZ Montážní lampa diodová bezpřívodová                     | E Lámpara inalámbrica de diodos                              |
|  | CN 引擎盖检修灯  |



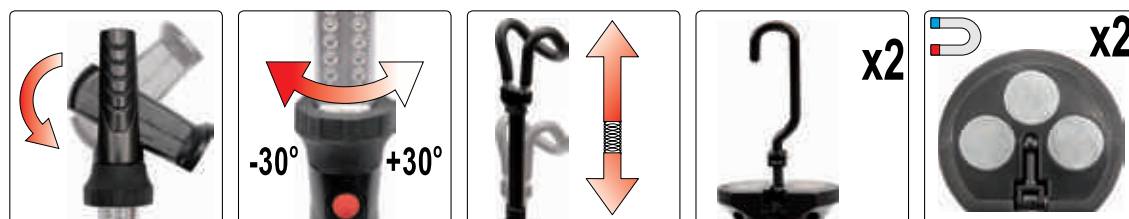

|   |   |   |               |                      |
|---|---|---|---------------|----------------------|
| <b>120 LED</b>                                  | <b>13000 MCD</b>                                  |   | <b>60 LED</b> | <b>120 LED</b>       |
| 7.2V<br>1800mAh<br>NI-MH                        | 230V~<br>50Hz<br>BATTERY<br>CHARGER<br>LADOWNARKA | WORK TIME<br>CZAS PRACY<br><b>8 h</b><br>60 LED |               | <b>4 h (120 LED)</b> |
| CHARGING TIME<br>CZAS ŁADOWANIA<br><b>4-5 h</b> |   | <b>HOOK<br/>HAK</b>                             |               | <b>MAGNETIC</b>      |
| <b>LED</b>                                      |   |   |               |                      |



GB Rubber protection extension cord  
 D Gummiisolierte Verlängerungsschnur  
 PL Przedłużacz w osłonie gumowej  
 RUS Удлинитель с резиновой изоляцией  
 CZ Prodlužovací kabel s gumovou izolací  
 H Gumi szigetelésű hosszabbító  
 RO Cablu prelungitor cauciuc  
 F Rallonge électrique  
 I Prolunga in gomma  
 E Cable de extensión con protección de caucho  
 CN 电缆延长线

**IP44** **16A**

CABLE **H05RR-F** **3G1.5 mm<sup>2</sup>**  
 KABEL CABLE / KABEL

**230V~50Hz**





| YATO     | L (m) |  |
|----------|-------|---|
| YT-81021 | 10    | 8   |
| YT-81022 | 20    | 4   |
| YT-81023 | 30    | 4   |
| YT-81024 | 40    | 2   |

GB Rubber protection extension cord  
 D Gummiisolierte Verlängerungsschnur  
 PL Przedłużacz w osłonie gumowej  
 RUS Удлинитель с резиновой изоляцией  
 CZ Prodlužovací kabel s gumovou izolací  
 H Gumi szigetelésű hosszabbító  
 RO Cablu prelungitor cauciuc  
 F Rallonge électrique  
 I Prolunga in gomma  
 E Cable de extensión con protección de caucho  
 CN 电缆延长线

**IP44** **16A**

CABLE **H05RR-F** **3G2.5 mm<sup>2</sup>**  
 KABEL CABLE / KABEL

**230V~50Hz**





| YATO    | L (m) |  |
|---------|-------|---|
| YT-8100 | 20    | 4   |
| YT-8101 | 30    | 2   |
| YT-8102 | 40    | 2   |

GB Rubber protection extension cord  
 D Gummiisolierte Verlängerungsschnur  
 PL Przedłużacz w osłonie gumowej  
 RUS Удлинитель с резиновой изоляцией  
 CZ Prodlužovací kabel s gumovou izolací  
 H Gumi szigetelésű hosszabbító  
 RO Cablu prelungitor cauciuc  
 F Rallonge électrique  
 I Prolunga in gomma  
 E Cable de extensión con protección de caucho  
 CN 电缆延长线

**IP44** **16A**

CABLE **H07RN-F** **3G1.5 mm<sup>2</sup>**  
 KABEL CABLE / KABEL

**230V~50Hz**





| YATO    | L (m) |  |
|---------|-------|---|
| YT-8110 | 2     | 40  |
| YT-8111 | 5     | 16  |
| YT-8112 | 10    | 8   |

GB Rubber protection extension cord  
 D Gummiisolierte Verlängerungsschnur  
 PL Przedłużacz w osłonie gumowej  
 RUS Удлинитель с резиновой изоляцией  
 CZ Prodlužovací kabel s gumovou izolací  
 H Gumi szigetelésű hosszabbító  
 RO Cablu prelungitor cauciuc  
 F Rallonge électrique  
 I Prolunga in gomma  
 E Cable de extensión con protección de caucho  
 CN 电缆延长线

**IP44** **16A**

CABLE **H07RN-F** **3G1.5 mm<sup>2</sup>**  
 KABEL CABLE / KABEL

**230V~50Hz**



| YATO     | L (m) |  |
|----------|-------|---|
| YT-8115  | 2     | 10  |
| YT-8116  | 10    | 4   |
| YT-81162 | 20    | 4   |



GB Cable reel  
D Kabeltrommel  
PL Przedłużacz zwijany  
RUS Удлинитель электрический  
CZ Bubnový prodloužovač  
H Kábeldob  
RO Prelungitor pe tambur  
F Rallonge électrique sur tambour enrouleur  
I Avvolgicavo con bobina  
E Cable de prolongación de tambor  
CN 电缆延长线



IP44 16A  
CABLE HO5RR-F KABEL 3G1.5 mm<sup>2</sup>  
E & F TYPE / TYP E TYPE / TYP  
230V~50Hz

•  $P_{max} = 1000\text{ W coiled}$   
 $P_{max} = 1000\text{ W zwinięty}$   
•  $P_{max} = 3000\text{ W uncoiled}$   
 $P_{max} = 3000\text{ W rozwinięty}$

| YATO     | L (m) |  |
|----------|-------|---|
| YT-81052 | 20    | 2   |
| YT-81053 | 30    | 2   |
| YT-81054 | 40    | 2   |

GB Cable reel  
D Kabeltrommel  
PL Przedłużacz zwijany  
RUS Удлинитель электрический  
CZ Bubnový prodloužovač  
H Kábeldob  
RO Prelungitor pe tambur  
F Rallonge électrique sur tambour enrouleur  
I Avvolgicavo con bobina  
E Cable de prolongación de tambor  
CN 电缆延长线



IP44 16A  
CABLE HO5RR-F KABEL 3G2.5 mm<sup>2</sup>  
E & F TYPE / TYP E TYPE / TYP  
PLASTIC REEL BEBEN PLÁSTIKOVÝ 230V~50Hz

•  $P_{max} = 1200\text{ W coiled}$   
 $P_{max} = 1200\text{ W zwinięty}$   
•  $P_{max} = 3600\text{ W uncoiled}$   
 $P_{max} = 3600\text{ W rozwinięty}$

| YATO    | L (m) |  |
|---------|-------|---|
| YT-8106 | 30    | 1   |
| YT-8107 | 40    | 1   |
| YT-8108 | 50    | 1   |

GB Drum power extension cord  
D Verlängerungstrommel für Kraftstrom  
PL Przedłużacz bębnowy silowy  
RUS Силовой удлинитель барабанного типа  
CZ Prodloužovací kabel silový na bubnu  
H Háromfázisú hosszabbító dob  
RO Derulator cu tambur  
F Rallonge électrique sur tambour enrouleur  
I Avvolgicavo di forza  
E Cilindro de extensión de fuerza  
CN 电缆延长线



IP44 ~400V ~230V  
CABLE H07RN-F KABEL 5G2.5 mm<sup>2</sup>  
3P+N+E SPANNE 3x 2P+E

• ~230V; 2P+E  
 $P_{max} = 1200\text{ W coiled}$   
 $P_{max} = 1200\text{ W zwinięty}$   
 $P_{max} = 3000\text{ W uncoiled}$   
 $P_{max} = 3000\text{ W rozwinięty}$

• ~400V; 3P+N+E  
 $P_{max} = 3000\text{ W coiled}$   
 $P_{max} = 3000\text{ W zwinięty}$   
 $P_{max} = 9000\text{ W uncoiled}$   
 $P_{max} = 9000\text{ W rozwinięty}$

| YATO    | L (m) |  |
|---------|-------|---|
| YT-8120 | 25    | 1   |

# 23

## Garden tools Narzędzia ogrodnicze





Watering program  
Program wodny

442-452



Trees and bushes care  
Pielęgnacja drzew i krzewów

453-458



Garden hose carts & holders

Wózki i stojaki na wąż ogrodowy..... 442

Spray guns & lances

Pistolety i lance zraszające..... 443

Spray nozzles

Zraszacze..... 447

Garden showers

Prysznice ogrodowe..... 449

Water timers

Sterowniki nawadniania..... 449

Connectors

Złączki..... 450

Couplings

Rozdzielacze..... 451

Sets

Zestawy..... 452

Hand hedge shears

Ręczne nożyce do żywopłotu..... 453

Garden pruners

Sekatory ogrodowe..... 454

Lopping shears

Sekatory do gałęzi..... 456

Saws for tall trees and bushes

Piły do wysokich drzew i krzewów..... 457

Garden hand saws

Piły ogrodowe ręczne..... 458

Axes

Siekiery..... 458

Garden care

Narzędzia do pielęgnacji ogrodu

459-461



Lawn care

Pielęgnacja trawnika

453



Hand grass shears

Ręczne nożyce do trawy..... 453

Small garden tools

Małe narzędzia ogrodowe..... 459

Garden hand saws



Piły ogrodowe ręczne..... 460

Big garden tools

Duże narzędzia ogrodowe..... 461



- GB Hose holder
- D Gartenschlauchträger
- PL Stojak do węzła ogrodowego
- RUS Барабан для намотки поливочного шланга
- CZ Stojan navijecí na zahradní hadici
- H Utartódob locsolótömlőhöz
- RO Suport pt. furtun
- F Dévidoir sur roues
- I Carrello avvolgitubo
- E Estante para manguera de jardín
- CN 卷线盘



|  |  |           |
|--|--|-----------|
|  3/4" (19 mm) |  1/2" (12.5 mm) | <b>PP</b> |
| 45 m   | 50 m   |           |



COLOR BOX



| YATO  | hose size / rozmiar węzła (m)                  |  |
|--|--|---|
| YT-99850   | 3/4" (19.0 mm) / 45 m<br>1/2" (12.5 mm) / 50 m | 2   |



- GB Hose holder
- D Gartenschlauchträger
- PL Stojak do węzła ogrodowego
- RUS Барабан для намотки поливочного шланга
- CZ Stojan navijecí na zahradní hadici
- H Utartódob locsolótömlőhöz
- RO Suport pt. furtun
- F Dévidoir sur roues
- I Carrello avvolgitubo
- E Estante para manguera de jardín
- CN 卷线盘



|  |  |           |
|--|--|-----------|
|  3/4" (19 mm) |  1/2" (12.5 mm) | <b>PP</b> |
| 45 m   | 50 m   |           |

COLOR BOX



| YATO  | hose size / rozmiar węzła (m)                  |  |
|--|--|---|
| YT-99852   | 3/4" (19.0 mm) / 45 m<br>1/2" (12.5 mm) / 50 m | 2   |



- GB Hose holder
- D Gartenschlauchträger
- PL Stojak do węzła ogrodowego
- RUS Барабан для намотки поливочного шланга
- CZ Stojan navijecí na zahradní hadici
- H Utartódob locsolótömlőhöz
- RO Suport pt. furtun
- F Dévidoir sur roues
- I Carrello avvolgitubo
- E Estante para manguera de jardín
- CN 卷线盘



|  |  |           |
|--|--|-----------|
|  3/4" (19 mm) |  1/2" (12.5 mm) | <b>PP</b> |
| 45 m   | 50 m   |           |

COLOR BOX



| YATO  | hose size / rozmiar węzła (m)                  |  |
|--|--|---|
| YT-99853   | 3/4" (19.0 mm) / 45 m<br>1/2" (12.5 mm) / 50 m | 2   |



GB Adjustable spray gun  
D Regelbare Sprühpistole  
PL Pistolet zraszający regulowany  
RUS Регулируемый оросительный пистолет  
CZ Kropící pistole regulovatelná

H Öntöző pisztoly, állítható sugarú  
RO Pistolet de irigare ajustabil  
F Pistolet d'arrosage réglé  
I Pistola a spruzzo regolabile  
E Pistola rociadora ajustable  
CN 调节式水枪

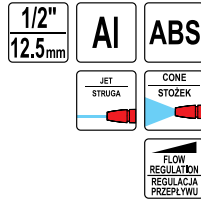

TIED ON CARD



YATO size / rozmiar  
YT-99833 1/2" / 12.5 mm 12/48

GB Adjustable spray gun  
D Regelbare Sprühpistole  
PL Pistolet zraszający regulowany  
RUS Регулируемый оросительный пистолет  
CZ Kropící pistole regulovatelná

H Öntöző pisztoly, állítható sugarú  
RO Pistolet de irigare ajustabil  
F Pistolet d'arrosage réglé  
I Pistola a spruzzo regolabile  
E Pistola rociadora ajustable  
CN 调节式水枪

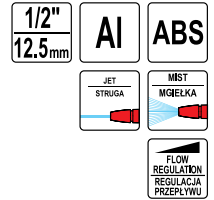

TIED ON CARD



YATO size / rozmiar  
YT-8965 1/2" / 12.5 mm 12/48

GB Adjustable spray gun  
D Regelbare Sprühpistole  
PL Pistolet zraszający regulowany  
RUS Регулируемый оросительный пистолет  
CZ Kropící pistole regulovatelná

H Öntöző pisztoly, állítható sugarú  
RO Pistolet de irigare ajustabil  
F Pistolet d'arrosage réglé  
I Pistola a spruzzo regolabile  
E Pistola rociadora ajustable  
CN 调节式水枪

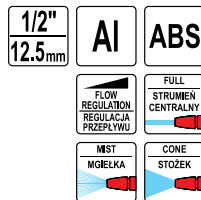

TIED ON CARD



YATO size / rozmiar  
YT-8955 1/2" / 12.5 mm 12/48

GB Adjustable spray gun  
D Regelbare Sprühpistole  
PL Pistolet zraszający regulowany  
RUS Регулируемый оросительный пистолет  
CZ Kropící pistole regulovatelná

H Öntöző pisztoly, állítható sugarú  
RO Pistolet de irigare ajustabil  
F Pistolet d'arrosage réglé  
I Pistola a spruzzo regolabile  
E Pistola rociadora ajustable  
CN 调节式水枪

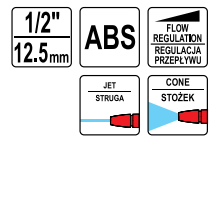

TIED ON CARD



YATO size / rozmiar  
YT-99834 1/2" / 12.5 mm 12/48

GB Adjustable spray gun  
D Regelbare Sprühpistole  
PL Pistolet zraszający regulowany  
RUS Регулируемый оросительный пистолет  
CZ Kropící pistole regulovatelná

H Öntöző pisztoly, állítható sugarú  
RO Pistolet de irigare ajustabil  
F Pistolet d'arrosage réglé  
I Pistola a spruzzo regolabile  
E Pistola rociadora ajustable  
CN 调节式水枪

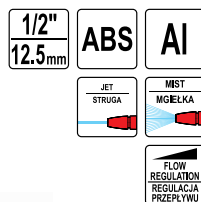

TIED ON CARD



YATO size / rozmiar  
YT-8966 1/2" / 12.5 mm 12/48

GB Adjustable spray gun  
D Regelbare Sprühpistole  
PL Pistolet zraszający regulowany  
RUS Регулируемый оросительный пистолет  
CZ Kropící pistole regulovatelná

H Öntöző pisztoly, állítható sugarú  
RO Pistolet de irigare ajustabil  
F Pistolet d'arrosage réglé  
I Pistola a spruzzo regolabile  
E Pistola rociadora ajustable  
CN 调节式水枪

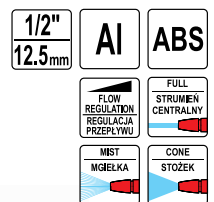

TIED ON CARD



YATO size / rozmiar  
YT-8956 1/2" / 12.5 mm 12/48



GB Adjustable spray gun  
D Regelbare Sprühpistole  
PL Pistolet zraszający regulowany  
RUS Регулируемый оросительный пистолет  
CZ Kropící pistole regulovatelná

H Öntöző pisztoly, állítható sugarú  
RO Pistolet de irigare ajustabil  
F Pistolet d'arrosage réglé  
I Pistola a spruzzo regolabile  
E Pistola rociadora ajustable  
CN 调节式水枪

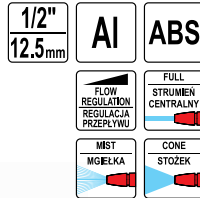

TIED ON CARD



YATO size / rozmiar  
YT-8957 1/2" / 12.5 mm 12/48

GB Adjustable spray gun  
D Regelbare Sprühpistole  
PL Pistolet zraszający regulowany  
RUS Регулируемый оросительный пистолет  
CZ Kropící pistole regulovatelná  
H Öntöző pisztoly, állítható sugarú

RO Pistolet de irigare ajustabil  
F Pistolet d'arrosage réglé  
I Pistola a spruzzo regolabile  
E Pistola rociadora ajustable  
CN 调节式水枪

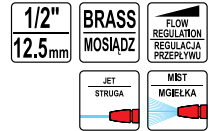

TIED ON CARD



YATO size / rozmiar  
YT-8967 1/2" / 12.5 mm 12

GB Multifunction sprinkling gun  
D Multifunktions-Spritzpistole  
PL Wielofunkcyjny pistolet zraszający  
RUS Многофункциональный оросительный пистолет  
CZ Multifunkční postřikovací pistole  
H Többfunkciós öntöző pisztoly

RO Pistol multifuncțional pt. pulverizare  
F Pistolet d'arrosage  
I Multifunzione pistola a spruzzo  
E Pistola para regar multifuncional  
CN 六用途调节式水枪

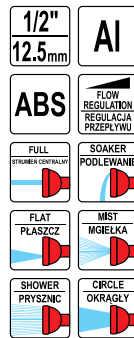

TIED ON CARD



YATO size / rozmiar  
YT-8958 1/2" / 12.5 mm 12/48

GB Multifunction sprinkling gun  
D Multifunktions-Spritzpistole  
PL Wielofunkcyjny pistolet zraszający  
RUS Многофункциональный оросительный пистолет  
CZ Multifunkční postřikovací pistole  
H Többfunkciós öntöző pisztoly

RO Pistol multifuncțional pt. pulverizare  
F Pistolet d'arrosage  
I Multifunzione pistola a spruzzo  
E Pistola para regar multifuncional  
CN 六用途调节式水枪

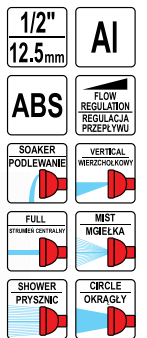

TIED ON CARD



YATO size / rozmiar  
YT-8964 1/2" / 12.5 mm 12/48

GB Multifunction sprinkling gun  
D Multifunktions-Spritzpistole  
PL Wielofunkcyjny pistolet zraszający  
RUS Многофункциональный оросительный пистолет  
CZ Multifunkční postřikovací pistole  
H Többfunkciós öntöző pisztoly

RO Pistol multifuncțional pt. pulverizare  
F Pistolet d'arrosage  
I Multifunzione pistola a spruzzo  
E Pistola para regar multifuncional  
CN 六用途调节式水枪



TIED ON CARD



YATO size / rozmiar  
YT-8963 1/2" / 12.5 mm 12/48

GB Multifunction sprinkling gun  
D Multifunktions-Spritzpistole  
PL Wielofunkcyjny pistolet zraszający  
RUS Многофункциональный оросительный пистолет  
CZ Multifunkční postřikovací pistole  
H Többfunkciós öntöző pisztoly

RO Pistol multifuncțional pt. pulverizare  
F Pistolet d'arrosage  
I Multifunzione pistola a spruzzo  
E Pistola para regar multifuncional  
CN 六用途调节式水枪

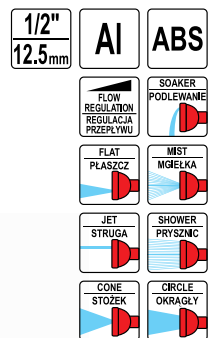

TIED ON CARD



YATO size / rozmiar  
YT-8959 1/2" / 12.5 mm 12/48



GB Multifunction sprinkling gun  
D Multifunktions-Spritzpistole  
PL Wielofunkcyjny pistolet zraszający  
RUS Многофункциональный оросительный пистолет  
CZ Multifunkční postřikovací pistole  
H Többfunkciós öntöző pisztoly

RO Pistol multifuncțional pt. pulverizare  
F Pistolet d'arrosage  
I Multifunzione pistola a spruzzo  
E Pistola para regar multifuncional  
CN 六用途调节式水枪

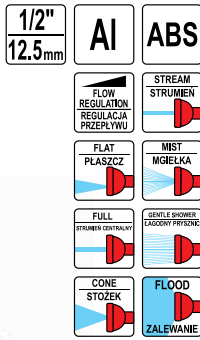

TIED ON CARD

**YATO** size / rozmiar  
YT-8960 1/2" / 12.5 mm 12/48

GB Multifunction sprinkling gun  
D Multifunktions-Spritzpistole  
PL Wielofunkcyjny pistolet zraszający  
RUS Многофункциональный оросительный пистолет  
CZ Multifunkční postřikovací pistole  
H Többfunkciós öntöző pisztoly

RO Pistol multifuncțional pt. pulverizare  
F Pistolet d'arrosage  
I Multifunzione pistola a spruzzo  
E Pistola para regar multifuncional  
CN 六用途调节式水枪

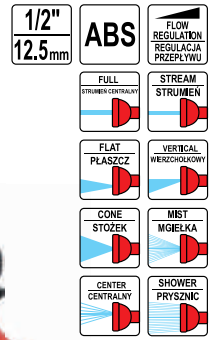

TIED ON CARD

**YATO** size / rozmiar  
YT-99841 1/2" / 12.5 mm 12/48

GB Multifunction sprinkling gun  
D Multifunktions-Spritzpistole  
PL Wielofunkcyjny pistolet zraszający  
RUS Многофункциональный оросительный пистолет  
CZ Multifunkční postřikovací pistole  
H Többfunkciós öntöző pisztoly

RO Pistol multifuncțional pt. pulverizare  
F Pistolet d'arrosage  
I Multifunzione pistola a spruzzo  
E Pistola para regar multifuncional  
CN 六用途调节式水枪

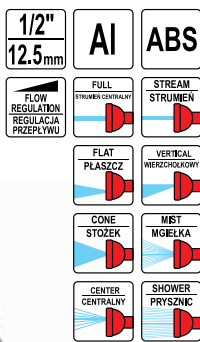

TIED ON CARD

**YATO** size / rozmiar  
YT-99840 1/2" / 12.5 mm 12/48

GB Multifunction sprinkling gun  
D Multifunktions-Spritzpistole  
PL Wielofunkcyjny pistolet zraszający  
RUS Многофункциональный оросительный пистолет  
CZ Multifunkční postřikovací pistole  
H Többfunkciós öntöző pisztoly

RO Pistol multifuncțional pt. pulverizare  
F Pistolet d'arrosage  
I Multifunzione pistola a spruzzo  
E Pistola para regar multifuncional  
CN 六用途调节式水枪

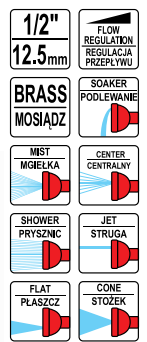

TIED ON CARD

**YATO** size / rozmiar  
YT-8968 1/2" / 12.5 mm 12

GB Sprinkling lance  
D Multifunktions-Spritzstab  
PL Lanza zraszająca wielofunkcyjna  
RUS Пика для распылителя многофункциональная  
CZ Multifunkční postřikovací nadstavec

H Többfunkciós esőztető fej  
RO Tijă pt. irigare  
F Pistolet lance d'arrosage télescopique  
I Spray lancia multifunzionale  
E Lanza para regar multifuncional  
CN 六用途调节式水枪

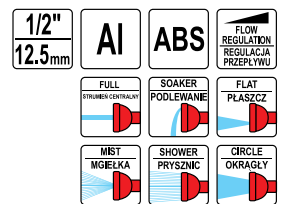

TIED ON CARD

**YATO** size / rozmiar  
YT-8961 1/2" / 12.5 mm 12

GB Garden shower  
 D Gartendusche  
 PL Pysznic ogrodowy  
 RUS Распылитель садовый  
 CZ Zahradní sprcha  
 H Kerti zuhany  
 RO Duș pt. grădină  
 F Pistolet lance  
 d'arrosage télescopique  
 I Doccia da giardino  
 E Regadera para jardín  
 CN 调节式水枪

1/2"  
12.5mm

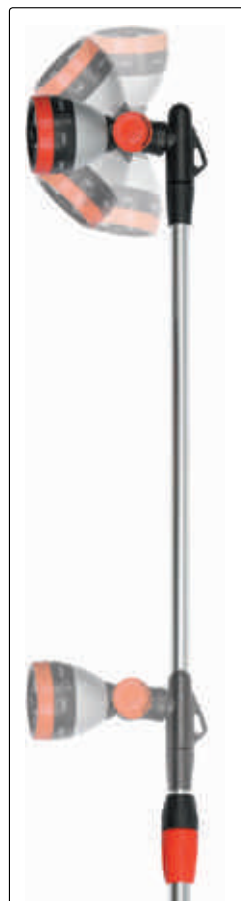
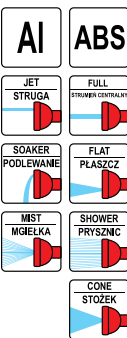

TIED ON CARD

|             |                |        |    |
|-------------|----------------|--------|----|
| <b>YATO</b> | size / rozmiar | L (cm) |    |
| YT-8962     | 1/2" / 12.5 mm | 90-135 | 12 |

GB Garden shower  
 D Gartendusche  
 PL Pysznic ogrodowy  
 RUS Распылитель садовый  
 CZ Zahradní sprcha  
 H Kerti zuhany  
 RO Duș pt. grădină  
 F Pistolet lance  
 d'arrosage télescopique  
 I Doccia da giardino  
 E Regadera para jardín  
 CN 调节式水枪

1/2"  
12.5mm

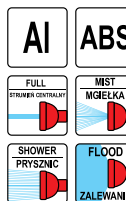

TIED ON CARD

|             |                |         |    |
|-------------|----------------|---------|----|
| <b>YATO</b> | size / rozmiar | L (cm)  |    |
| YT-99843    | 1/2" / 12.5 mm | 100-145 | 12 |



GB Adjustable spray nozzle  
D Spritze  
PL Zraszacz prosty regulowany  
RUSРаспылитель поливочный  
CZ Postřikovač  
H Szórófej  
RO Stropitor apă

F Pistolet d'arrosage droit et réglé  
I Semplice sprinkler regolabile  
E Rociador  
CN 铝合金调节式水枪

1/2"  
12.5mm Zn ABS



TIED ON CARD

|             |                |       |
|-------------|----------------|-------|
| <b>YATO</b> | size / rozmiar |       |
| YT-8950     | 1/2" / 12.5 mm | 12/48 |

GB Adjustable spray nozzle  
D Spritze  
PL Zraszacz prosty regulowany  
RUSРаспылитель поливочный  
CZ Postřikovač  
H Szórófej  
RO Stropitor apă

F Pistolet d'arrosage droit et réglé  
I Semplice sprinkler regolabile  
E Rociador  
CN 铝合金调节式水枪

1/2"  
12.5mm ABS



TIED ON CARD

|             |                |       |
|-------------|----------------|-------|
| <b>YATO</b> | size / rozmiar |       |
| YT-99830    | 1/2" / 12.5 mm | 12/48 |

GB Impulse sprinkler  
D Impulssprenger  
PL Zraszacz impulsowy  
RUSРаспылитель импульсный на пике  
CZ Postřikovač  
H Impulzus szórófej  
RO Stropitor apă  
F Arroseur impulsion sur piquet  
I Sprinkler impulso  
E Rociador  
CN 脉冲洒水器

MAX RANGE ZASEG MAKSYMALNY 24 m  
ZINC ALLOY SPIKE KOLEC ZE STOPU CYNKU  
ABS



TIED ON CARD

|             |    |
|-------------|----|
| <b>YATO</b> |    |
| YT-8985     | 48 |

GB Impulse sprinkler  
D Impulssprenger  
PL Zraszacz impulsowy  
RUSРаспылитель импульсный на пике  
CZ Postřikovač  
H Impulzus szórófej  
RO Stropitor apă  
F Arroseur impulsion sur piquet  
I Sprinkler impulso  
E Rociador  
CN 脉冲洒水器

MAX RANGE ZASEG MAKSYMALNY 24 m  
ZINC ALLOY SPIKE KOLEC ZE STOPU CYNKU  
ABS



TIED ON CARD

|             |    |
|-------------|----|
| <b>YATO</b> |    |
| YT-8986     | 48 |

GB 3-arms revolving sprinkler  
D 3-Arm Kreis-Regner  
PL Zraszacz 3-ramienny  
RUSТрёхсторонний вращающийся распылитель на пике  
CZ Rozprašovac třiramenný  
H Locsoló, leszűrhető, forgó  
RO Aspersol cu 3 brate  
F Arroseur sur piquet 3 branches  
I Tre braccio sprinkler  
E Rociador 3-brazos  
CN 三叉插针洒水器

ZINC ALLOY SPIKE KOLEC ZE STOPU CYNKU  
ABS



TIED ON CARD

|             |    |
|-------------|----|
| <b>YATO</b> |    |
| YT-8987     | 48 |

GB Tripod impulse sprinkler  
D Impulssprenger  
PL Zraszacz impulsowy na statywie  
RUSРаспылитель импульсный  
CZ Postřikovač  
H Impulzus szórófej  
RO Stropitor apă  
F Arroseur impulsion lance  
I Sprinkler impulso su un treppiede  
E Rociador  
CN 洒水器

ABS   
AI



COLOR BOX



|             |    |
|-------------|----|
| <b>YATO</b> |    |
| YT-8984     | 12 |

- GB Impulse sprinkler with base
- D Impulssprenger
- PL Zraszacz impulsowy naziemny
- RUS Распылитель импульсный
- CZ Postřikovač
- H Impulzus szórófej
- RO Stropitor apă
- F Turbine d'arrosage
- I Sprinkler impulso a terra
- E Rociador
- CN 脉冲洒水器



MAX RANGE  
ZASIEG  
MAKSYMALNY  
**24 m**

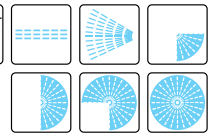

COLOR BOX

|             |    |
|-------------|----|
| <b>YATO</b> |    |
| YT-8988     | 24 |

- GB 8 pattern sprinkler
- D 8-Flächenregner
- PL Zraszacz 8-funkcyjny
- RUS Распылитель 8-позиционный на подставке
- CZ Postríkovač
- H 8 funkciós szórófej
- RO Stropitor apă cu 8 duze
- F Turbine d'arrosage 8 fonctionnes
- I Sprinkler 8-funzioni
- E Rociador 8-funciones de tierra
- CN 洒水器



FLOW  
REGULATION  
REGULACJA  
PRZEPŁYWU

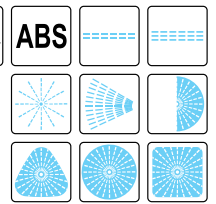

TIED ON CARD

|             |    |
|-------------|----|
| <b>YATO</b> |    |
| YT-8991     | 48 |

- GB Aluminium tube oscillating sprinkler
- D Viereckregner
- PL Zraszacz oscylacyjny z rurką aluminiową
- RUS Распылитель осциллирующий
- CZ Postríkovač
- H Oszillációs szórófej
- RO Stropitor apă
- F Arroseur oscillant aluminium
- I Oscillante sprinkler con tubo di alluminio
- E Rociador giratorio con tubo de aluminio
- CN 摇摆洒水器

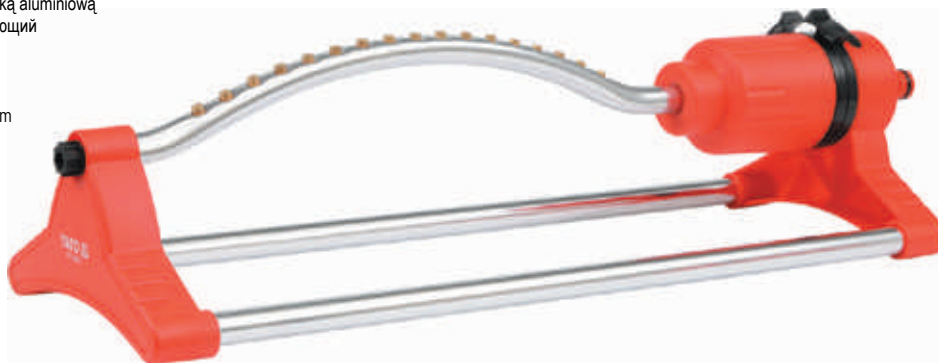

**17**  
HOLES  
OTWORÓW

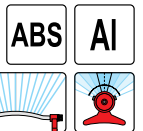

COLOR BOX



|             |   |
|-------------|---|
| <b>YATO</b> |   |
| YT-8993     | 6 |

- GB Tube oscillating sprinkler
- D Viereckregner
- PL Zraszacz oscylacyjny
- RUS Распылитель осциллирующий
- CZ Postríkovač
- H Oszillációs szórófej
- RO Stropitor apă
- F Arroseur oscillant
- I Oscillante sprinkler
- E Rociador giratorio
- CN 摇摆洒水器



**17**  
HOLES  
OTWORÓW

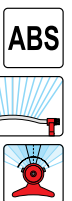

COLOR BOX



|             |   |
|-------------|---|
| <b>YATO</b> |   |
| YT-99845    | 6 |



GB Sprinkling lance  
D Multifunktions-Spritzstab  
PL Lanza zraszająca wielofunkcyjna  
RUS Пистолет для распылителя  
многофункциональная

CZ Multifunkční postřikovací nadstavec  
H Többfunkciós esőztető fej  
RO Tijă pt. irigare  
F Pistolet lance d'arrosage  
télescopique

I Spray lancia multifunzionale  
E Lanza para regar multifuncional  
CN 六用途调节式水枪

1/2"  
12.5mm

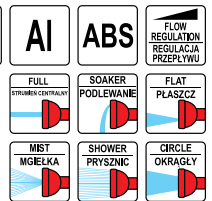

TIED ON CARD

| YATO    | size / rozmiar |    |
|---------|----------------|----|
| YT-8961 | 1/2" / 12.5 mm | 12 |

GB Garden shower  
D Gartendusche  
PL Pysznica ogrodowy  
RUS Распылитель садовый  
CZ Zahradní sprcha  
H Kerti zuhany  
RO Duș pt. grădină  
F Pistolet lance  
d'arrosage télescopique  
I Doccia da giardino  
E Regadera para jardín  
CN 调节式水枪



1/2"  
12.5mm

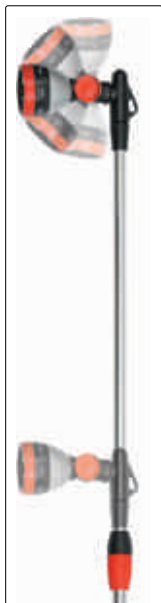

TIED ON CARD

| YATO    | size / rozmiar | L (cm) |    |
|---------|----------------|--------|----|
| YT-8962 | 1/2" / 12.5 mm | 90-135 | 12 |

GB Garden shower  
D Gartendusche  
PL Pysznica ogrodowy  
RUS Распылитель садовый  
CZ Zahradní sprcha  
H Kerti zuhany  
RO Duș pt. grădină  
F Pistolet lance  
d'arrosage télescopique  
I Doccia da giardino  
E Regadera para jardín  
CN 调节式水枪



1/2"  
12.5mm



TIED ON CARD

| YATO     | size / rozmiar | L (cm)  |    |
|----------|----------------|---------|----|
| YT-99843 | 1/2" / 12.5 mm | 100-145 | 12 |

GB Multifunction preset water timer  
D Bewässerungsuhr  
PL Sterownik nawadniania  
RUS Таймер для управления подачей воды  
CZ Zavlazovací hodiny  
H Vízprogramozó óra  
RO Programator automat  
F Conducteur d'arrosage  
I Controller irrigazione  
E Programador manual  
para tubos de agua  
CN 多功能洒水定时器



DOUBLE BLISTER



| YATO    |  |    |
|---------|--|----|
| YT-9955 |  | 12 |

GB Hose connector  
 D Universal  
 Schnellschlauchkupplung  
 PL Złącze standard  
 RUS Соединитель  
 CZ Rychlospojka  
 H Fitting  
 RO Mufă pt. pistol  
 F Raccord standard  
 I Connettore standard  
 E Junta estandar  
 CN 通水接头

1/2"  
 12.5mm  
**ABS**



TIED ON CARD

| YATO     | size / rozmiar  |       |
|----------|-----------------|-------|
| YT-99801 | 1/2"<br>12.5 mm | 12/48 |

GB Waterstop hose connector  
 D Universal  
 Schnellschlauchkupplung  
 mit Wasserstop  
 PL Złącze stop  
 RUS Соединитель с автостопом  
 CZ Rychlospojka  
 H Fitting  
 RO Mufă pt. pistol  
 F Raccord stop  
 I Connettore stop  
 E Junta estandar  
 CN 止水接头

1/2"  
 12.5mm  
**ABS**  
**STOP**



TIED ON CARD

| YATO     | size / rozmiar  |       |
|----------|-----------------|-------|
| YT-99803 | 1/2"<br>12.5 mm | 12/48 |

GB Hose mender  
 D Schlauchreparatur,  
 Schlauchverbinder  
 PL Reparatör do węzła  
 RUS Соединитель шлангов  
 CZ Opravka  
 H Gyorstoldó  
 RO Mufă înădire  
 F Réparateur de tuyau  
 I Tubo reparatore  
 E Reparador para manguera  
 CN 修补接头

1/2"  
 12.5mm  
**ABS**



TIED ON CARD

| YATO     | size / rozmiar  |       |
|----------|-----------------|-------|
| YT-99810 | 1/2"<br>12.5 mm | 12/48 |

GB Hose connector  
 D Universal  
 Schnellschlauchkupplung  
 PL Złącze standard  
 RUS Соединитель  
 CZ Rychlospojka  
 H Fitting  
 RO Mufă pt. pistol  
 F Raccord standard  
 I Connettore standard  
 E Junta estandar  
 CN 通水接头

3/4"  
 19mm  
**ABS**



TIED ON CARD

| YATO     | size / rozmiar  |       |
|----------|-----------------|-------|
| YT-99802 | 3/4"<br>19.0 mm | 12/48 |

GB Waterstop hose connector  
 D Universal  
 Schnellschlauchkupplung  
 mit Wasserstop  
 PL Złącze stop  
 RUS Соединитель с автостопом  
 CZ Rychlospojka  
 H Fitting  
 RO Mufă pt. pistol  
 F Raccord stop  
 I Connettore stop  
 E Junta estandar  
 CN 止水接头

3/4"  
 19mm  
**ABS**  
**STOP**



TIED ON CARD

| YATO     | size / rozmiar  |       |
|----------|-----------------|-------|
| YT-99804 | 3/4"<br>19.0 mm | 12/48 |

GB Hose mender  
 D Schlauchreparatur,  
 Schlauchverbinder  
 PL Reparatör do węzła  
 RUS Соединитель шлангов  
 CZ Opravka  
 H Gyorstoldó  
 RO Mufă înădire  
 F Réparateur de tuyau  
 I Tubo reparatore  
 E Reparador para manguera  
 CN 修补接头

3/4"  
 19mm  
**ABS**



TIED ON CARD

| YATO     | size / rozmiar  |       |
|----------|-----------------|-------|
| YT-99811 | 3/4"<br>19.0 mm | 12/48 |

GB Hose mender  
 D Schlauchreparatur,  
 Schlauchverbinder  
 PL Reparatör do węzła  
 RUS Соединитель шлангов  
 CZ Opravka  
 H Gyorstoldó  
 RO Mufă înădire  
 F Réparateur de tuyau  
 I Tubo reparatore  
 E Reparador para manguera  
 CN 修补接头

1/2"  
 3/4"  
 12.5mm  
 19mm  
**ABS**



TIED ON CARD

| YATO    | size / rozmiar              |        |
|---------|-----------------------------|--------|
| YT-8979 | 1/2"; 3/4"<br>12.5; 19.0 mm | 24/240 |

GB Hose connector  
 D Universal  
 Schnellschlauchkupplung  
 PL Złącze standard  
 RUS Соединитель  
 CZ Rychlospojka  
 H Fitting  
 RO Mufă pt. pistol  
 F Raccord standard  
 I Connettore standard  
 E Junta estandar  
 CN 通水接头

1/2"  
 12.5mm  
**Zn**



TIED ON CARD

| YATO     | size / rozmiar  |       |
|----------|-----------------|-------|
| YT-99825 | 1/2"<br>12.5 mm | 12/48 |

GB Waterstop hose connector  
 D Universal  
 Schnellschlauchkupplung  
 mit Wasserstop  
 PL Złącze stop  
 RUS Соединитель с автостопом  
 CZ Rychlospojka  
 H Fitting  
 RO Mufă pt. pistol  
 F Raccord stop  
 I Connettore stop  
 E Junta estandar  
 CN 止水接头

1/2"  
 12.5mm  
**Zn**  
**STOP**



TIED ON CARD

| YATO     | size / rozmiar  |       |
|----------|-----------------|-------|
| YT-99827 | 1/2"<br>12.5 mm | 12/48 |

GB Hose connector  
 D Universal  
 Schnellschlauchkupplung  
 PL Złącze standard  
 RUS Соединитель  
 CZ Rychlospojka  
 H Fitting  
 RO Mufă pt. pistol  
 F Raccord standard  
 I Connettore standard  
 E Junta estandar  
 CN 通水接头

3/4"  
 19mm  
**Zn**



TIED ON CARD

| YATO     | size / rozmiar  |       |
|----------|-----------------|-------|
| YT-99826 | 3/4"<br>19.0 mm | 12/48 |

GB Waterstop hose connector  
 D Universal  
 Schnellschlauchkupplung  
 mit Wasserstop  
 PL Złącze stop  
 RUS Соединитель с автостопом  
 CZ Rychlospojka  
 H Fitting  
 RO Mufă pt. pistol  
 F Raccord stop  
 I Connettore stop  
 E Junta estandar  
 CN 止水接头

3/4"  
 19mm  
**Zn**  
**STOP**



TIED ON CARD

| YATO     | size / rozmiar  |       |
|----------|-----------------|-------|
| YT-99828 | 3/4"<br>19.0 mm | 12/48 |

GB Snap-in tap adaptor  
 D Wasserhahnanschluss  
 für Gartenschlauch  
 PL Przyłącze do kranu  
 RUS Адаптер внутренний  
 CZ Šroubení  
 H Tömövég csaphoz  
 RO Mufă pt. robinet  
 cu filet interior  
 F Raccord  
 I Collegamento al rubinetto  
 E Tubuladura de grifo  
 CN 铁箍接头

1/2"  
 12.5mm  
**ABS**



TIED ON CARD

| YATO    | size / rozmiar  |        |
|---------|-----------------|--------|
| YT-8970 | 1/2"<br>12.5 mm | 24/240 |



GB Snap-in tap adaptor  
D Wasserhahnanschluss für Gartenschlauch  
PL Przyłącze do kranu  
RUSAдaптер внyтpeнний  
CZ Šroubení  
H Tömlovég csaphoz  
RO Mufă pt. robinet cu file interior  
F Raccord  
I Collegamento al rubinetto  
E Tubuladura de grifo  
CN 铁箍接头

3/4"  
19mm

ABS



TIED ON CARD

| YATO    | size / rozmiar  |        |
|---------|-----------------|--------|
| YT-8971 | 3/4"<br>19.0 mm | 12/120 |

GB Snap-in tap adaptor  
D Wasserhahnanschluss für Gartenschlauch  
PL Przyłącze do kranu  
RUSAдaптер внyтpeнний  
CZ Šroubení  
H Tömlovég csaphoz  
RO Mufă pt. robinet cu file interior  
F Raccord  
I Collegamento al rubinetto  
E Tubuladura de grifo  
CN 铁箍接头

3/4"  
19mm

ABS



TIED ON CARD

| YATO     | size / rozmiar  |        |
|----------|-----------------|--------|
| YT-99812 | 3/4"<br>19.0 mm | 12/120 |

GB Snap-in tap adaptor  
D Wasserhahnanschluss für Gartenschlauch  
PL Przyłącze do kranu  
RUSAдaптер внyтpeнний  
CZ Šroubení  
H Tömlovég csaphoz  
RO Mufă pt. robinet cu file interior  
F Raccord  
I Collegamento al rubinetto  
E Tubuladura de grifo  
CN 铁箍接头

1"  
25mm

ABS



TIED ON CARD

| YATO    | size / rozmiar |        |
|---------|----------------|--------|
| YT-8972 | 1"<br>25.0 mm  | 12/120 |

GB Snap-in tap adaptor  
D Wasserhahnanschluss für Gartenschlauch  
PL Przyłącze do kranu  
RUSAдaптер внyтpeнний  
CZ Šroubení  
H Tömlovég csaphoz  
RO Mufă pt. robinet cu file interior  
F Raccord  
I Collegamento al rubinetto  
E Tubuladura de grifo  
CN 铁箍接头

1"  
25mm

ABS



TIED ON CARD

| YATO     | size / rozmiar |        |
|----------|----------------|--------|
| YT-99813 | 1"<br>25.0 mm  | 12/120 |

GB Snap-in tap adaptor  
D Wasserhahnanschluss für Gartenschlauch  
PL Przyłącze do kranu  
RUSAдaптер внyтpeнний  
CZ Šroubení  
H Tömlovég csaphoz  
RO Mufă pt. robinet cu file interior  
F Raccord  
I Collegamento al rubinetto  
E Tubuladura de grifo  
CN 铁箍接头

1/2"  
3/4"

12.5 mm  
19 mm

ABS



TIED ON CARD

| YATO    | size / rozmiar              |        |
|---------|-----------------------------|--------|
| YT-8973 | 1/2"; 3/4"<br>12.5; 19.0 mm | 12/120 |

GB Snap-in tap adaptor  
D Wasserhahnanschluss für Gartenschlauch  
PL Przyłącze do kranu  
RUSAдaптер внyтpeнний  
CZ Šroubení  
H Tömlovég csaphoz  
RO Mufă pt. robinet cu file interior  
F Raccord  
I Collegamento al rubinetto  
E Tubuladura de grifo  
CN 铁箍接头

1/2"  
3/4"

12.5 mm  
19 mm

ABS



TIED ON CARD

| YATO     | size / rozmiar              |        |
|----------|-----------------------------|--------|
| YT-99814 | 1/2"; 3/4"<br>12.5; 19.0 mm | 12/120 |

GB Snap-in tap adaptor  
D Wasserhahnanschluss für Gartenschlauch  
PL Przyłącze do kranu  
RUSAдaптер внyтpeнний  
CZ Šroubení  
H Tömlovég csaphoz  
RO Mufă pt. robinet cu file interior  
F Raccord  
I Collegamento al rubinetto  
E Tubuladura de grifo  
CN 铁箍接头

3/4"  
1"

19 mm  
25 mm

ABS



TIED ON CARD

| YATO    | size / rozmiar            |        |
|---------|---------------------------|--------|
| YT-8974 | 3/4"; 1"<br>19.0; 25.0 mm | 12/120 |

GB Snap-in tap adaptor  
D Wasserhahnanschluss für Gartenschlauch  
PL Przyłącze do kranu  
RUSAдaптер внyтpeнний  
CZ Šroubení  
H Tömlovég csaphoz  
RO Mufă pt. robinet cu file interior  
F Raccord  
I Collegamento al rubinetto  
E Tubuladura de grifo  
CN 铁箍接头

3/4"  
1"

19 mm  
25 mm

ABS



TIED ON CARD

| YATO     | size / rozmiar            |        |
|----------|---------------------------|--------|
| YT-99815 | 3/4"; 1"<br>19.0; 25.0 mm | 12/120 |

GB Snap-in tap adaptor  
D Wasserhahnanschluss für Gartenschlauch  
PL Przyłącze do kranu  
RUSAдaптер внyтpeнний  
CZ Šroubení  
H Tömlovég csaphoz  
RO Mufă pt. robinet cu file interior  
F Raccord  
I Collegamento al rubinetto  
E Tubuladura de grifo  
CN 铁箍接头

3/4"  
19mm

ABS



TIED ON CARD

| YATO    | size / rozmiar  |        |
|---------|-----------------|--------|
| YT-8975 | 3/4"<br>19.0 mm | 24/240 |

GB 2 way coupling  
D Schlauchkupplung  
PL Złącze typu „I”  
RUSСoединитель шлангов  
CZ Spojka  
H „I” típusú csötöldó idom  
RO Prelungitor furturn apă  
F Connecteur type „I”  
I Connettore tipo „I”  
E Junta tipo „I”  
CN 双向水管接头

1/2"  
12.5mm

ABS



TIED ON CARD

| YATO    | size / rozmiar  |        |
|---------|-----------------|--------|
| YT-8976 | 1/2"<br>12.5 mm | 24/240 |

GB 3 way coupling  
D Drei wege kupplung  
PL Rozdzielacz typu „Y”  
RUSТройник для шлангов  
CZ Y-kus  
H „Y” típusú elágazás  
RO Distributor 3 căi  
F Dérivation type „Y”  
I Connettore tipo „Y”  
E Distribuidor tipo „Y”  
CN 三向水管接头

1/2"  
12.5mm

ABS



TIED ON CARD

| YATO    | size / rozmiar  |        |
|---------|-----------------|--------|
| YT-8977 | 1/2"<br>12.5 mm | 24/240 |

GB Y-switch coupling with swivel  
 D 2-Wege Ventil  
 PL Rozdzielacz z zaworami  
 RUS Распределитель внешний  
 CZ Rozbočovač s uzavíracími ventily  
 H Y-elágazó, 2 db külső menetes elzáróval  
 RO Racord iny cu robinet  
 F Dérivation type „Y”  
 I Distributore con valvole  
 E Distribuidor tipo „Y”  
 CN 双通水管转换接头

1/2"  
 12.5mm

ABS



TIED ON CARD

| YATO    | size / rozmiar  |        |
|---------|-----------------|--------|
| YT-8978 | 1/2"<br>12.5 mm | 24/240 |

GB One way tap adaptor  
 D Garten-Ventil  
 PL Zawór ogrodowy  
 RUS Вентиль  
 CZ Ventil

H Szelep  
 RO Robinet  
 F Raccord régulateur  
 I Valvola giardino  
 E Válvula  
 CN 接头

1/2"  
 12.5mm

BRASS  
 MOSIADZ

AI

ABS



TIED ON CARD

| YATO    | size / rozmiar  |       |
|---------|-----------------|-------|
| YT-9940 | 1/2"<br>12.5 mm | 12/48 |

GB Y-switch coupling with swivel  
 D 2-Wege Ventil  
 PL Rozdzielacz z zaworami  
 RUS Распределитель внешний  
 CZ Rozbočovač s uzavíracími ventily  
 H Y-elágazó, 2 db külső menetes elzáróval  
 RO Racord iny cu robinet  
 F Soupape double  
 I Distributore con valvole  
 E Distribuidor tipo „Y”  
 CN 两用转换接头

1/2"  
 12.5mm

3/4"  
 19mm

1"

25mm

ABS



TIED ON CARD

| YATO     | size / rozmiar  |       |
|----------|-----------------|-------|
| YT-99848 | 1/2"<br>12.5 mm | 12/48 |

GB Y-switch coupling with swivel  
 D 2-Wege Ventil  
 PL Rozdzielacz z zaworami  
 RUS Набор поливочный  
 CZ Rozbočovač s uzavíracími ventily  
 H Y-elágazó, 2 db külső menetes elzáróval  
 RO Racord iny cu robinet  
 F Raccord régulateur double  
 I Distributore con valvole  
 E Distribuidor tipo „Y”  
 CN 两用转换接头

1/2"  
 12.5mm

3/4"  
 19mm

1"  
 25mm

BRASS  
 MOSIADZ

AI

ABS



TIED ON CARD

| YATO    | size / rozmiar  |       |
|---------|-----------------|-------|
| YT-9941 | 1/2"<br>12.5 mm | 12/48 |

GB Basic hose set with straight nozzle  
 D Bewässerungs Spritz und Anschlusset  
 PL Zestaw złączek ze zraszaczem prostym  
 RUS Набор поливочный  
 CZ Postřikovač + spojky  
 H Készlet gyorskapocsos csaphoz  
 RO Ștut furtun apă cu accesorii pt. robinet  
 F Set d'arrosage raccord  
 I Set raccordi con sprinkler semplice  
 E Juego de rociar tubuladura de grifo  
 CN 水枪组套

1/2"  
 3/4"

12.5 mm  
 19 mm

ABS

STOP

∅ 3/4" (19 mm)



TIED ON CARD

| YATO    | size / rozmiar              |       |
|---------|-----------------------------|-------|
| YT-8940 | 1/2"; 3/4"<br>12.5; 19.0 mm | 12/48 |

GB Basic hose set with straight nozzle  
 D Bewässerungs Spritz und Anschlusset  
 PL Zestaw złączek ze zraszaczem prostym  
 RUS Набор поливочный  
 CZ Postřikovač + spojky  
 H Készlet gyorskapocsos csaphoz  
 RO Ștut furtun apă cu accesorii pt. robinet  
 F Set d'arrosage raccord  
 I Set raccordi con sprinkler semplice  
 E Juego de rociar tubuladura de grifo  
 CN 水枪组套

1/2"  
 3/4"

1"  
 1"

12.5;  
 19; 25 mm

ABS

STOP

∅ 3/4" (19 mm)



TIED ON CARD

| YATO    | size / rozmiar                              |       |
|---------|---|-------|
| YT-8941 | 1/2"; 3/4"; 1"<br>12.5 mm; 19.0 mm; 25.0 mm | 12/48 |

GB Basic hose set with straight nozzle  
 D Bewässerungs Spritz und Anschlusset  
 PL Zestaw złączek ze zraszaczem prostym  
 RUS Набор поливочный  
 CZ Postřikovač + spojky  
 H Készlet gyorskapocsos csaphoz  
 RO Ștut furtun apă cu accesorii pt. robinet  
 F Set d'arrosage raccord  
 I Set raccordi con sprinkler semplice  
 E Juego de rociar tubuladura de grifo  
 CN 水枪组套

1/2"  
 3/4"  
 1"

12.5;  
 19; 25 mm

ABS

STOP

∅ 3/4" (19 mm)



TIED ON CARD

| YATO     | size / rozmiar                              |       |
|----------|---|-------|
| YT-99821 | 1/2"; 3/4"; 1"<br>12.5 mm; 19.0 mm; 25.0 mm | 12/48 |

GB Basic hose set with straight nozzle  
 D Bewässerungs Spritz und Anschlusset  
 PL Zestaw złączek ze zraszaczem prostym  
 RUS Набор поливочный  
 CZ Postřikovač + spojky  
 H Készlet gyorskapocsos csaphoz  
 RO Ștut furtun apă cu accesorii pt. robinet  
 F Set d'arrosage raccord  
 I Set raccordi con sprinkler semplice  
 E Juego de rociar tubuladura de grifo  
 CN 水枪组套

1/2"  
 3/4"  
 1"

12.5;  
 19; 25 mm

ABS

Zn

STOP

∅ 3/4" (19 mm)



TIED ON CARD

| YATO    | size / rozmiar                              |       |
|---------|---|-------|
| YT-8943 | 1/2"; 3/4"; 1"<br>12.5 mm; 19.0 mm; 25.0 mm | 12/48 |

GB Set of gaskets  
 D Dichtungssatz  
 PL Zestaw uszczeltek do programu wodnego  
 RUS Набор прокладок  
 CZ Sada těsnění  
 H Tömítéskészlet  
 RO Set de garnituri

F Kit of joints  
 I Set di guarnizioni per programma del acqua  
 E Juego de juntas  
 CN 垫圈组套

14  
 PCS

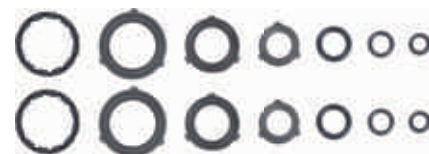

2 x Ø16 x Ø11.0 x 2.5  
 2 x Ø18.5 x Ø11.0 x 3.0  
 2 x Ø30.0 x Ø20.0 x 3.0  
 2 x Ø10.0 x Ø6.0 x 2.0  
 2 x Ø24.0 x Ø15.0 x 3.0  
 2 x Ø12.0 x Ø8.0 x 2.0  
 2 x basket

POLYBAG  
 WITH HEADER



| YATO    | for / dla       |       |
|---------|-----------------|-------|
| YT-9920 | YT-8900-YT-8994 | 20/80 |



GB Grass shears  
D Handgrassschere  
PL Nożyce do trawy wielopozycyjne  
RUS Ножницы для стрижки травы  
CZ Nožnice na trávu  
H Forgatható fűviryó olló

RO Foarfeca pt. gazon  
F Cisaille à gazon  
I Cesioie per erba multifunzione  
E Tijeras de cesped  
CN 草剪

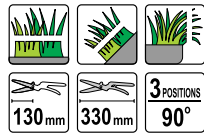

130mm 330mm 3 POSITIONS 90°

PTFE COATED



TRY ME  
HALF BLISTER  
CARD

| YATO    | L (mm) |       |
|---------|--------|-------|
| YT-8851 | 330    | 12/60 |

# 1050 mid carbon steel blades

GB Grass shears  
D Handgrassschere  
PL Nożyce do trawy wielopozycyjne  
RUS Ножницы для стрижки травы  
CZ Nožnice na trávu  
H Forgatható fűviryó olló

RO Foarfeca pt. gazon  
F Cisaille à gazon  
I Cesioie per erba multifunzione  
E Tijeras de cesped  
CN 草剪

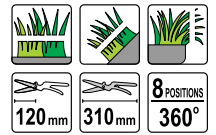

120mm 310mm 8 POSITIONS 360°

PTFE COATED



TRY ME  
HALF BLISTER  
CARD

| YATO    | L (mm) |      |
|---------|--------|------|
| YT-8852 | 310    | 6/24 |

# 1050 mid carbon steel blades

GB Grass shears  
D Handgrassschere  
PL Nożyce do trawy wielopozycyjne  
RUS Ножницы для стрижки травы  
CZ Nožnice na trávu  
H Forgatható fűviryó olló

RO Foarfeca pt. gazon  
F Cisaille à gazon  
I Cesioie per erba multifunzione  
E Tijeras de cesped  
CN 草剪

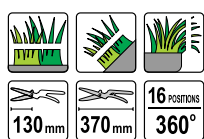

130mm 370mm 16 POSITIONS 360°

S50C PTFE COATED



TRY ME  
HALF BLISTER  
CARD

| YATO    | L (mm) |      |
|---------|--------|------|
| YT-8853 | 370    | 6/72 |

GB Grass shears  
D Handgrassschere  
PL Nożyce do trawy wielopozycyjne  
RUS Ножницы для стрижки травы  
CZ Nožnice na trávu  
H Forgatható fűviryó olló

RO Foarfeca pt. gazon  
F Cisaille à gazon  
I Cesioie per erba multifunzione  
E Tijeras de cesped  
CN 草剪

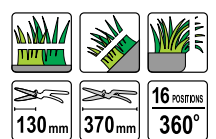

130mm 370mm 16 POSITIONS 360°

S50C PTFE COATED



TRY ME  
HALF BLISTER  
CARD

| YATO    | L (mm) |      |
|---------|--------|------|
| YT-8854 | 370    | 6/72 |

# 1050 mid carbon steel blades

GB Hedge shears  
D Heckenschere  
PL Nożyce do żywoplotu  
RUS Кусторезы  
CZ Nožnice na živý plot  
H Sövényvágó olló

RO Foarfeca pt. gard viu  
F Cisaille à haie  
I Cesioie per le siepe  
E Tijeras para seto vivo  
CN 整篱剪

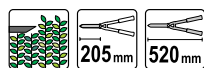

205mm 520mm



HANGING CARD & POUCH ON BLADE

| YATO    | L (mm) |    |
|---------|--------|----|
| YT-8821 | 520    | 24 |

# 1050 mid carbon steel blades

GB Hedge shears  
D Heckenschere  
PL Nożyce do żywoplotu  
RUS Кусторезы  
CZ Nožnice na živý plot  
H Sövényvágó olló  
RO Foarfeca pt. gard viu

F Cisaille à haie  
I Cesioie per le siepe  
E Tijeras para seto vivo  
CN 整篱剪



205mm 550mm



HANGING CARD & POUCH ON BLADE

| YATO    | L (mm) |    |
|---------|--------|----|
| YT-8822 | 550    | 12 |

# 1050 mid carbon steel blades

GB Hedge shears  
D Heckenschere  
PL Nożyce do żywoplotu  
RUS Кусторезы  
CZ Nožnice na živý plot  
H Sövényvágó olló

RO Foarfeca pt. gard viu  
F Cisaille à haie  
I Cesioie per le siepe  
E Tijeras para seto vivo  
CN 整篱剪

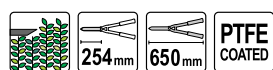

254mm 650mm PTFE COATED



HANGING CARD & POUCH ON BLADE

| YATO    | L (mm) |    |
|---------|--------|----|
| YT-8823 | 650    | 12 |

# 1050 mid carbon steel blades

GB Telescopic hedge shears  
D Heckenschere  
PL Teleskopowe nożyce do żywoplotu  
RUS Кусторезы с телескопическими ручками  
CZ Nožnice na živý plot  
H Sövényvágó olló

RO Foarfeca pt. gard viu  
F Cisaille télescopique à haie  
I Cesioie telescopiche per siepe  
E Tijeras para seto vivo  
CN 可伸缩整篱剪

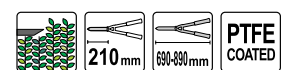

210mm 690-890mm PTFE COATED



HANGING CARD & POUCH ON BLADE

| YATO    | L (mm)  |   |
|---------|---------|---|
| YT-8824 | 690-890 | 6 |

# 50 mid carbon steel blades

GB By-pass pruner  
D Rebenschere  
PL Sekator uniwersalny  
RUS Секатор  
CZ Nožnice zahradnicke  
H Metszoolló

RO Foarfece pt. pomi  
F Sécateur traditionnel  
I Cesioie universale  
E Podadera universal  
CN 剪枝剪

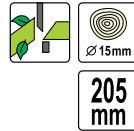

TRY ME  
HALF BLISTER  
CARD

|             |        |       |
|-------------|--------|-------|
| <b>YATO</b> | L (mm) |       |
| YT-8800     | 205    | 12/72 |

mid carbon steel blades

GB By-pass pruner  
D Rebenschere  
PL Sekator uniwersalny  
RUS Секатор  
CZ Nožnice zahradnicke  
H Metszoolló

RO Foarfece pt. pomi  
F Sécateur traditionnel  
I Cesioie universale  
E Podadera universal  
CN 剪枝剪



TRY ME  
HALF BLISTER  
CARD

|             |        |       |
|-------------|--------|-------|
| <b>YATO</b> | L (mm) |       |
| YT-8801     | 220    | 12/72 |

high carbon steel blades

GB By-pass pruner  
D Rebenschere  
PL Sekator uniwersalny  
RUS Секатор  
CZ Nožnice zahradnicke  
H Metszoolló

RO Foarfece pt. pomi  
F Sécateur traditionnel  
I Cesioie universale  
E Podadera universal  
CN 剪枝剪

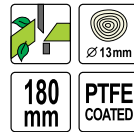

TRY ME  
HALF BLISTER  
CARD

|             |        |       |
|-------------|--------|-------|
| <b>YATO</b> | L (mm) |       |
| YT-8805     | 180    | 12/72 |

high carbon steel blades

GB By-pass pruner  
D Rebenschere  
PL Sekator uniwersalny  
RUS Секатор  
CZ Nožnice zahradnicke  
H Metszoolló

RO Foarfece pt. pomi  
F Sécateur traditionnel  
I Cesioie universale  
E Podadera universal  
CN 剪枝剪



TRY ME  
HALF BLISTER  
CARD

|             |        |       |
|-------------|--------|-------|
| <b>YATO</b> | L (mm) |       |
| YT-8811     | 190    | 12/72 |

GB By-pass pruner  
D Rebenschere  
PL Sekator uniwersalny  
RUS Секатор  
CZ Nožnice zahradnicke  
H Metszoolló

RO Foarfece pt. pomi  
F Sécateur traditionnel  
I Cesioie universale  
E Podadera universal  
CN 剪枝剪



TRY ME  
HALF BLISTER  
CARD

|             |        |       |
|-------------|--------|-------|
| <b>YATO</b> | L (mm) |       |
| YT-8845     | 200    | 12/72 |

GB By-pass pruner  
D Rebenschere  
PL Sekator uniwersalny  
RUS Секатор  
CZ Nožnice zahradnicke  
H Metszoolló

RO Foarfece pt. pomi  
F Sécateur traditionnel  
I Cesioie universale  
E Podadera universal  
CN 剪枝剪

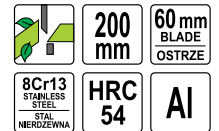

SLIDING  
CARD

|             |        |       |
|-------------|--------|-------|
| <b>YATO</b> | L (mm) |       |
| YT-8790     | 200    | 12/60 |

GB By-pass pruner  
D Rebenschere  
PL Sekator uniwersalny  
RUS Секатор  
CZ Nožnice zahradnicke  
H Metszoolló

RO Foarfece pt. pomi  
F Sécateur traditionnel  
I Cesioie universale  
E Podadera universal  
CN 剪枝剪



TRY ME  
HALF BLISTER  
CARD

|             |        |      |
|-------------|--------|------|
| <b>YATO</b> | L (mm) |      |
| YT-8843     | 180    | 5/60 |

GB By-pass pruner  
D Rebenschere  
PL Sekator uniwersalny  
RUS Секатор  
CZ Nožnice zahradnicke  
H Metszoolló

RO Foarfece pt. pomi  
F Sécateur traditionnel  
I Cesioie universale  
E Podadera universal  
CN 剪枝剪



TRY ME  
HALF BLISTER  
CARD

|             |        |       |
|-------------|--------|-------|
| <b>YATO</b> | L (mm) |       |
| YT-8849     | 200    | 12/72 |



GB Professional anvil pruner  
D Amboss-Gartenschere  
PL Sekator kowadełkowy  
RUS Секатор  
CZ Nožnice zahradnicke  
H Metszoolló

RO Foarfece pt. pomi  
F Sécateur à enclume  
I Cesioie anvil  
E Podadera  
de bigornia  
CN 棘轮剪枝剪

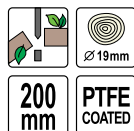

200 mm PTFE COATED



TRY ME  
HALF BLISTER  
CARD

| YATO    | L (mm) |       |
|---------|--------|-------|
| YT-8802 | 200    | 12/72 |

high carbon steel blades

GB Ratchet by-pass pruner  
D Gartenschere  
PL Sekator z grzechotką  
RUS Секатор  
CZ Nožnice zahradnicke  
H Metszoolló

RO Foarfece pt. pomi  
F Sécateur à cliquet  
I Cesioie con cricchetto  
E Podadera  
con carraca  
CN 棘轮剪枝剪



200 mm

SK5 PTFE COATED



TRY ME HALF  
BLISTER CARD

| YATO    | L (mm) |       |
|---------|--------|-------|
| YT-8808 | 200    | 12/72 |

GB Professional anvil pruner  
D Amboss-Gartenschere  
PL Sekator kowadełkowy  
RUS Секатор  
CZ Nožnice zahradnicke  
H Metszoolló

RO Foarfece pt. pomi  
F Sécateur à enclume  
I Cesioie anvil  
E Podadera  
de bigornia  
CN 棘轮剪枝剪



210 mm SK5 PTFE COATED



TRY ME  
HALF BLISTER  
CARD

| YATO    | L (mm) |       |
|---------|--------|-------|
| YT-8809 | 210    | 12/72 |

GB Professional anvil pruner  
D Amboss-Gartenschere  
PL Sekator kowadełkowy  
RUS Секатор  
CZ Nožnice zahradnicke  
H Metszoolló

RO Foarfece pt. pomi  
F Sécateur à enclume  
I Cesioie anvil  
E Podadera  
de bigornia  
CN 棘轮剪枝剪



200 mm 40 mm BLADE OSTRZE

8Cr13 STAINLESS STEEL STAŁ NIERDZEWNA

HRC 54

AI



SLIDING  
CARD

| YATO    | L (mm) |       |
|---------|--------|-------|
| YT-8792 | 200    | 12/60 |

GB Ratchet by-pass pruner  
D Gartenschere  
PL Sekator z grzechotką  
RUS Секатор  
CZ Nožnice zahradnicke  
H Metszoolló

RO Foarfece pt. pomi  
F Sécateur à cliquet  
I Cesioie con cricchetto  
E Podadera  
con carraca  
CN 棘轮剪枝剪



200 mm SK5 PTFE COATED



TRY ME  
HALF BLISTER  
CARD

| YATO    | L (mm) |       |
|---------|--------|-------|
| YT-8807 | 200    | 12/72 |

GB Fruit and flower shears  
D Blumen- und Rebschere  
PL Sekator do obcinania zawiązków  
RUS Секатор  
CZ Nožnice zahradnicke  
H Metszoolló

RO Foarfece pt. pomi  
F Sécateur  
I Cesioia taglio gemme  
E Podadera para cortar germenos  
CN 花枝剪



200 mm 55 mm BLADE OSTRZE

8Cr13 STAINLESS STEEL STAŁ NIERDZEWNA

HRC 54

AI



SLIDING  
CARD

| YATO    | L (mm) |       |
|---------|--------|-------|
| YT-8791 | 200    | 12/60 |

GB Fruit and flower shears  
D Blumen- und Rebschere  
PL Sekator do obcinania zawiązków  
RUS Секатор  
CZ Nožnice zahradnicke  
H Metszoolló

RO Foarfece pt. pomi  
F Sécateur  
I Cesioia taglio gemme  
E Podadera para cortar germenos  
CN 花枝剪



180 mm SK5



SLIDING  
CARD

| YATO    | L (mm) |       |
|---------|--------|-------|
| YT-8815 | 180    | 12/72 |

GB Fruit and flower shears  
D Blumen- und Rebschere  
PL Sekator do obcinania zawiązków  
RUS Секатор  
CZ Nožnice zahradnicke  
H Metszoolló

RO Foarfece pt. pomi  
F Sécateur  
I Cesioia taglio gemme  
E Podadera para cortar germenos  
CN 花枝剪



190 mm SK5



SLIDING  
CARD

| YATO    | L (mm) |       |
|---------|--------|-------|
| YT-8816 | 190    | 12/72 |

GB Fruit and flower shears  
D Blumen- und Rebschere  
PL Sekator do obcinania zawiązków  
RUSСекатор  
CZ Nožnice zahradnicke  
H Metszoolló

RO Foarfece pt. pomi  
F Sécateur  
I Cesoia tagliarame  
E Podadera para cortar germenos  
CN 花枝剪

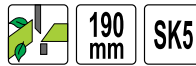

| YATO    | L (mm) |       |
|---------|--------|-------|
| YT-8817 | 190    | 12/72 |

GB Fruit and flower shears  
D Blumen- und Rebschere  
PL Sekator do obcinania zawiązków  
RUSСекатор  
CZ Nožnice zahradnicke  
H Metszoolló

RO Foarfece pt. pomi  
F Sécateur  
I Cesoia tagliarame  
E Podadera para cortar germenos  
CN 花枝剪



| YATO    | L (mm) |       |
|---------|--------|-------|
| YT-8850 | 200    | 12/72 |

GB By-pass lopping shears  
D Astschere  
PL Sekator do gałęzi  
RUSСучкорез  
CZ Nožnice zahradnicke  
H Ágvágó fix  
RO Foarfece curbata pt. taiat crengi

F Coupe-branches à lame franche  
I Cesoia tagliarame  
E Podadera para ramas  
CN 高枝剪

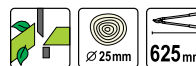

| YATO    | L (mm) |    |
|---------|--------|----|
| YT-8831 | 625    | 12 |

# 1050 mid carbon steel blades

GB Anvil lopping shears  
D Amboss Astschere  
PL Sekator kowadelkowy do gałęzi  
RUSСучкорез  
CZ Nožnice zahradnicke  
H Ágvágó fix  
RO Foarfece curbata pt. taiat crengi

F Coupe-branches à éclume  
I Cesoia anvil tagliarame  
E Podadera para ramas, de bigornia  
CN 高枝剪



| YATO    | L (mm) |    |
|---------|--------|----|
| YT-8832 | 635    | 12 |

# 1050 mid carbon steel blades

GB By-pass lopping shears  
D Astschere  
PL Sekator do gałęzi  
RUSСучкорез  
CZ Nožnice zahradnicke  
H Ágvágó fix  
RO Foarfece curbata pt. taiat crengi

F Coupe-branches à lame franche  
I Cesoia tagliarame  
E Podadera para ramas  
CN 高枝剪

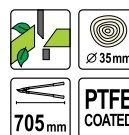

| YATO    | L (mm) |    |
|---------|--------|----|
| YT-8833 | 705    | 12 |

# 1050 mid carbon steel blades

GB Anvil lopping shears  
D Amboss Astschere  
PL Sekator kowadelkowy do gałęzi  
RUSСучкорез  
CZ Nožnice zahradnicke  
H Ágvágó fix  
RO Foarfece curbata pt. taiat crengi

F Coupe-branches à éclume  
I Cesoia anvil tagliarame  
E Podadera para ramas, de bigornia  
CN 高枝剪



| YATO    | L (mm) |    |
|---------|--------|----|
| YT-8834 | 700    | 12 |

# 1050 mid carbon steel blades

GB By-pass lopping shears  
D Astschere  
PL Sekator do gałęzi  
RUSСучкорез  
CZ Nožnice zahradnicke  
H Ágvágó fix  
RO Foarfece curbata pt. taiat crengi

F Coupe-branches à lame franche  
I Cesoia tagliarame  
E Podadera para ramas  
CN 高枝剪



| YATO    | L (mm) |    |
|---------|--------|----|
| YT-8835 | 780    | 12 |

# 1050 mid carbon steel blades

GB Anvil lopping shears  
D Amboss Astschere  
PL Sekator kowadelkowy do gałęzi  
RUSСучкорез  
CZ Nožnice zahradnicke  
H Ágvágó fix  
RO Foarfece curbata pt. taiat crengi

F Coupe-branches à éclume  
I Cesoia anvil tagliarame  
E Podadera para ramas, de bigornia  
CN 高枝剪



| YATO    | L (mm) |    |
|---------|--------|----|
| YT-8836 | 770    | 12 |

# 1050 mid carbon steel blades



GB Telescopic by-pass lopping shears  
D Astschere  
PL Sekator teleskopowy do gałęzi  
RUS Секатор с телескопическими ручками  
CZ Nožnice zahradnicke  
H Ágvágó teleszkópos

RO Foarfeca curbata pt. taiat crengi  
F Coupe-branches télescopique  
I Cesoie tagliarami telescopica  
E Podadera telescópica para ramas  
CN 可伸缩高枝剪



HANGING CARD & POUCH ON BLADE

| YATO    | L (mm)  |      |
|---------|---------|------|
| YT-8838 | 630-960 | 6/12 |

mid carbon steel blades

GB Telescopic by-pass lopping shears  
D Astschere  
PL Sekator teleskopowy do gałęzi  
RUS Секатор с телескопическими ручками  
CZ Nožnice zahradnicke  
H Ágvágó teleszkópos

RO Foarfeca curbata pt. taiat crengi  
F Coupe-branches télescopique  
I Cesoie tagliarami telescopica  
E Podadera telescópica para ramas  
CN 可伸缩高枝剪



HANGING CARD & POUCH ON BLADE

| YATO    | L (mm)  |   |
|---------|---------|---|
| YT-8839 | 650-900 | 6 |

GB Telescopic by-pass lopping shears  
D Astschere  
PL Sekator teleskopowy do gałęzi  
RUS Секатор с телескопическими ручками  
CZ Nožnice zahradnicke  
H Ágvágó teleszkópos

RO Foarfeca curbata pt. taiat crengi  
F Coupe-branches télescopique  
I Cesoie tagliarami telescopica  
E Podadera telescópica para ramas  
CN 可伸缩高枝剪

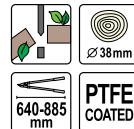

HANGING CARD & POUCH ON BLADE

| YATO    | L (mm)  |    |
|---------|---------|----|
| YT-8840 | 640-885 | 12 |

GB Telescopic by-pass lopping shears  
D Astschere  
PL Sekator teleskopowy do gałęzi  
RUS Секатор с телескопическими ручками  
CZ Nožnice zahradnicke  
H Ágvágó teleszkópos

RO Foarfeca curbata pt. taiat crengi  
F Coupe-branches télescopique  
I Cesoie tagliarami telescopica  
E Podadera telescópica para ramas  
CN 可伸缩高枝剪



HANGING CARD & POUCH ON BLADE

| YATO    | L (mm)  |   |
|---------|---------|---|
| YT-8841 | 690-930 | 6 |

GB Telescopic by-pass lopping shears  
D Astschere  
PL Sekator teleskopowy do gałęzi  
RUS Секатор с телескопическими ручками  
CZ Nožnice zahradnicke  
H Ágvágó teleszkópos

RO Foarfeca curbata pt. taiat crengi  
F Coupe-branches télescopique  
I Cesoie tagliarami telescopica  
E Podadera telescópica para ramas  
CN 可伸缩高枝剪

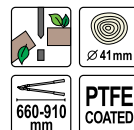

HANGING CARD & POUCH ON BLADE

| YATO    | L (mm)  |    |
|---------|---------|----|
| YT-8842 | 660-910 | 12 |

GB Leverage tree pruner  
D Baumsäge mit astschere  
PL Sekator gašenicowy z piłą  
RUS Сучкорез штанговый с пилой  
CZ Střiháč na větve s pilovým listem  
H Koteles ágvágó  
RO Fierastrau pt. pomi cu prelungitor  
F Système de scie à poulie  
I Taglio pista con sega  
E Podadera de palanca con sierra  
CN 高枝锯



DOUBLE BLISTER

| YATO    | L (mm) |    |
|---------|--------|----|
| YT-8876 | 325    | 12 |

GB Bow saw  
D Bùgelsäge  
PL Pila kabląkowa  
RUS Лучковая пила  
CZ Oblouková pila  
H Keretes fűrés

RO Ferăstrău de curbură  
F Scie à bûches  
I Sega ad arco  
E Sierra de arco  
CN 两用弓锯

COLOR SLEEVE



HCS 65



2  
FUNCTION

FOR WOOD AND METAL  
DO DREWNA I METALU

FOR WOOD  
DO DREWNA

| YATO    | L (mm) |       |
|---------|--------|-------|
| YT-3200 | 300    | 12/24 |

| YATO    | L (mm) |       |
|---------|--------|-------|
| YT-3201 | 450    | 12/24 |
| YT-3202 | 530    |       |
| YT-3203 | 610    |       |
| YT-3204 | 760    |       |

GB Blade for dry wood  
D Trockenholzsägeblatt für Handsäge  
PL Brzeszczot do drewna suchego  
RUS Лезвие для работы по сухому дереву  
CZ Pilový list na suché dřevo

H Fűrészlap száraz fához  
RO Lama pt. lemn uscat  
F Lame à bois sec  
I Lama per il legno secco  
E Hoja de sierra para madera seca  
CN 干木锯条

HCS 65

DRY WOOD  
DREWNO  
SUCHE



COLOR SLEEVE

| YATO    | L (mm) |        |
|---------|--------|--------|
| YT-3221 | 450    | 50/200 |
| YT-3222 | 530    |        |
| YT-3223 | 610    |        |
| YT-3224 | 760    |        |

GB Blade for wet wood  
D Nassholzsägeblatt für Handsäge  
PL Brzeszczot do drewna mokrego  
RUS Лезвие для работы по влажному дереву  
CZ Pilový list na mokré dřevo

H Fűrészlap nedves fához  
RO Lama pt. lemn verde  
F Lame à bois humide  
I Lama per il legno bagnato  
E Hoja de sierra para madera mojada  
CN 湿木锯条

HCS 65

WET WOOD  
DREWNO  
MOKRE



COLOR SLEEVE

| YATO    | L (mm) |        |
|---------|--------|--------|
| YT-3230 | 300    | 50/200 |
| YT-3231 | 450    |        |
| YT-3232 | 530    |        |
| YT-3233 | 610    |        |
| YT-3234 | 760    |        |

GB Axe  
D Beil Hicorystiel  
PL Siekiera

RUS Tonop  
CZ Sekerka  
H Szekerce

RO Secure  
F Hache  
I Ascia

E Hacha  
CN 把斧

DIN 5131  
7294

GENUINE HICKORY

Timber wedge and steel ring

Genuine hickory shaft



Forged carbon steel head hardened and tempered

| YATO    | m (g) | L (mm) | DIN  |    |
|---------|-------|--------|------|----|
| YT-8001 | 600   | 360    | 5131 | 24 |
| YT-8002 | 800   | 380    | 5131 | 20 |
| YT-8003 | 1000  | 430    | 5131 | 12 |
| YT-8004 | 1250  | 710    | 7294 | 12 |
| YT-8005 | 1400  | 710    | 7294 | 12 |
| YT-8006 | 1600  | 810    | 7294 | 12 |

GB Axe  
D Beil Hicorystiel  
PL Siekiera

RUS Tonop  
CZ Sekerka  
H Szekerce

RO Secure  
F Hache  
I Ascia

E Hacha  
CN 把斧

GENUINE HICKORY

Timber wedge and steel ring

Genuine hickory shaft



Forged carbon steel head hardened and tempered

| YATO    | m (g) | L (mm) |   |
|---------|-------|--------|---|
| YT-8011 | 1000  | 515    | 6 |
| YT-8012 | 2000  | 820    | 6 |





GB Transplanter  
D Blumenkelle  
PL Łopátka  
RUS Совок посадочный  
CZ Lopatka  
H Ásó  
RO Mini-lopatá gradinarit  
F Transplantoir  
I Spatola  
E Paleta estrecha  
CN 移植器

**350 mm**

**CARBON STEEL**





| YATO  | L (mm) |  |
|--|--------|---|
| YT-8865  | 350    | 10/60   |

GB Rake  
D Blumenrechen  
PL Grabki  
RUS Грабли  
CZ Hrabičky  
H Gereblye  
RO Mini grebla  
F Râteau  
I Rastrelli  
E Rastrillo  
CN 园艺耙

**325 mm**

**CARBON STEEL**





| YATO  | L (mm) |  |
|--|--------|---|
| YT-8866  | 325    | 10/60   |

GB 3-line fork & rake  
D Kleinhacke  
PL Motyczka + pazurki  
RUS Рыхлитель комбинированный  
CZ Motyčka s kultivátorem  
H Kapa és kultivátor  
RO Sapaliga + cultivator  
F Rateau et bêche  
I Zappa + artigli  
E Escarificador tres dientes con azadilla  
CN 园艺耙

**310 mm**

**CARBON STEEL**





| YATO  | L (mm) |  |
|--|--------|---|
| YT-8867  | 310    | 10/60   |

GB Cultivator  
D Grubber  
PL Pazurki  
RUS Рыхлитель  
CZ Kultivátor  
H Kultivátor  
RO Cultivator  
F Griffe piocheuse  
I Artigli  
E Escarificador  
CN 园艺耙

**420 mm**

**CARBON STEEL**





| YATO  | L (mm) |  |
|--|--------|---|
| YT-8868  | 420    | 10/60   |

GB Garden rake  
D Landschaftsbesen  
PL Grabki wachlarzowe  
RUS Грабли веерные  
CZ Hrabičky  
H Kerti gereblye  
RO Grebla de gradina  
F Râteau  
I Rastrelli ventilatore  
E Rastrillo de abanico de hojalata  
CN 园艺耙

**400 mm**

**CARBON STEEL**





| YATO  | L (mm) |  |
|--|--------|---|
| YT-8869  | 400    | 10/60   |

GB Transplanter  
D Blumenkelle  
PL Łopátka  
RUS Совок посадочный  
CZ Lopatka  
H Ásó  
RO Mini-lopatá gradinarit  
F Transplantoir  
I Spatola  
E Paleta estrecha  
CN 移植器

**360 mm**

**CARBON STEEL**





| YATO  | L (mm) |  |
|--|--------|---|
| YT-8870  | 360    | 10/60   |

GB Transplanter  
D Blumenkelle  
PL Łopátka  
RUS Совок посадочный  
CZ Lopatka  
H Ásó  
RO Mini-lopatá gradinarit  
F Transplantoir  
I Spatola  
E Paleta estrecha  
CN 移植器

**340 mm**

**CHROME PLATED**





| YATO  | L (mm) |  |
|--|--------|---|
| YT-8885  | 340    | 12/72   |

GB Transplanter  
D Blumenkelle  
PL Łopátka  
RUS Совок посадочный  
CZ Lopatka  
H Ásó  
RO Mini-lopatá gradinarit  
F Transplantoir  
I Spatola  
E Paleta estrecha  
CN 移植器

**340 mm**

**CHROME PLATED**





| YATO  | L (mm) |  |
|--|--------|---|
| YT-8886  | 340    | 12/72   |

GB Hoe  
D Garten handhacke  
PL Motyczka  
RUS Мотыжка  
CZ Motyčka  
H Kerti kapa  
RO Sapaliga  
F Binette  
I Zappetta  
E Azadilla  
CN 园艺锄

**280 mm**

**CHROME PLATED**





| YATO  | L (mm) |  |
|--|--------|---|
| YT-8889  | 280    | 12/72   |

GB Cultivator  
D Grubber  
PL Pazurki  
RUS Рыхлитель  
CZ Kultivátor  
H Kultivátor  
RO Cultivator  
F Griffe piocheuse  
I Artigli  
E Escarificador  
CN 园艺耙

**270 mm**

**CHROME PLATED**





| YATO  | L (mm) |  |
|--|--------|---|
| YT-8890  | 270    | 12/72   |

GB Rolling tiller  
D Rollpflüger  
PL Spulchniaz  
RUS Рыхлитель дисковый  
CZ Kypříč púdy  
H Görgös talajlazító  
RO Maruntitor pt. pamant  
F Émietteur  
I Collivatore  
E Escarificador  
CN 松土器

**370 mm**

**CHROME PLATED**





| YATO  | L (mm) |  |
|--|--------|---|
| YT-8891  | 370    | 12/72   |

GB Hoe + cultivator  
D Kleinhacke  
PL Motyczka z pazurkami  
RUS Рыхлитель комбинированный  
CZ Motyčka s hrabičkami  
H Kerti villás kapa  
RO Sapaliga + cultivator  
F Serfouette  
I Zappetta con artigli  
E Azadilla con escarificador  
CN 园艺锄

**320 mm**

**CHROME PLATED**



| YATO  | L (mm) |  |
|--|--------|---|
| YT-8892  | 320    | 12/72   |

- GB Dibble
- D Pflanzler
- PL Pikownik ogrodniczy
- RUS Конус посадочный с деревянной ручкой
- CZ Zahradnický přepichovač
- H Kerti palántázó
- RO Chitonag pt. grădină
- F Plantoir
- I Foraterra
- E Picadeor de jardín
- CN 挖洞器



280 mm

STAINLESS STEEL  
STAL  
NEROZEWNA

| YATO    | L (mm) |       |
|---------|--------|-------|
| YT-8894 | 280    | 10/60 |

- GB Bow saw
- D Bügelsäge
- PL Pila kablakowa
- RUS Лучковая пила
- CZ Oblouková pila
- H Keretes fűrész
- RO Ferăstrău de curbură
- F Scie à bûches
- I Segà ad arco
- E Sierra de arco
- CN 两用弓锯



COLOR SLEEVE



HCS 65

2 FUNCTION FOR WOOD AND METAL DO DREWNA I METALU

| YATO    | L (mm) |       |
|---------|--------|-------|
| YT-3200 | 300    | 12/24 |



FOR WOOD DO DREWNA

| YATO    | L (mm) |       |
|---------|--------|-------|
| YT-3201 | 450    | 12/24 |
| YT-3202 | 530    |       |
| YT-3203 | 610    |       |
| YT-3204 | 760    |       |

- GB Blade for dry wood
- D Trockenholzsägeblatt für Handsäge
- PL Brzeczot do drewna suchego
- RUS Лезвие для работы по сухому дереву
- CZ Pilový list na suché dřevo

- H Fűrészlap száraz fához
- RO Lama pt. lemn uscat
- F Lama à bois sec
- I Lama per il legno secco
- E Hoja de sierra para madera seca
- CN 干木锯条

HCS 65

DRY WOOD DREWNO SUCHE



COLOR SLEEVE

| YATO    | L (mm) |        |
|---------|--------|--------|
| YT-3221 | 450    | 50/200 |
| YT-3222 | 530    |        |
| YT-3223 | 610    |        |
| YT-3224 | 760    |        |

- GB Blade for wet wood
- D Nassholzsägeblatt für Handsäge
- PL Brzeczot do drewna mokrego
- RUS Лезвие для работы по влажному дереву
- CZ Pilový list na mokré dřevo

- H Fűrészlap nedves fához
- RO Lama pt. lemn verde
- F Lama à bois humide
- I Lama per il legno bagnato
- E Hoja de sierra para madera mojada
- CN 湿木锯条

HCS 65

WET WOOD DREWNO MOKRE



COLOR SLEEVE

| YATO    | L (mm) |        |
|---------|--------|--------|
| YT-3230 | 300    | 50/200 |
| YT-3231 | 450    |        |
| YT-3232 | 530    |        |
| YT-3233 | 610    |        |
| YT-3234 | 760    |        |





GB Spade  
D Rodespaten  
PL Szpadel  
RUSЗаступ  
CZ Lisovaný rýč kalená  
H Ásó, sajtoló-edzett  
RO Hârleț cu coadă  
F Bêche à bord pointu  
I Spatola  
E Pala  
CN 铲

120  
cm

HRC  
40-48

1050Mn  
STEEL



|   |        |   |
|---|--------|---|
| <b>YATO</b>  | L (cm) |  |
| YT-86804  | 120    | 6   |



GB Spade  
D Rodespaten  
PL Szpadel  
RUSЗаступ  
CZ Lisovaný rýč kalená  
H Ásó, sajtoló-edzett  
RO Hârleț cu coadă  
F Bêche à bord droit  
I Spatola  
E Pala  
CN 铲

120  
cm

HRC  
40-48

1050Mn  
STEEL



|   |        |   |
|---|--------|---|
| <b>YATO</b>  | L (cm) |  |
| YT-86800  | 120    | 6   |



GB Shovel  
D Schaufel  
PL Łopata  
RUSЛопата  
CZ Osazený rýč  
H Homoklapát, ékelt  
RO Lopată pt. nisip  
F Pelle à charbon  
I Palla  
E Pala  
CN 鏟子

120  
cm

HRC  
40-48

1050Mn  
STEEL



|   |        |   |
|---|--------|---|
| <b>YATO</b>  | L (cm) |  |
| YT-86801  | 120    | 6   |



GB Shovel  
D Schaufel  
PL Łopata ogrodnicza  
RUSЛопата совковая  
песочная  
CZ Osazený  
rýč pískový  
H Homoklapát, ékelt  
RO Lopată pt. nisip  
F Pelle à sable  
I Palla  
E Pala  
CN 鏟子

120  
cm

HRC  
40-48

1050Mn  
STEEL





|   |        |   |
|---|--------|---|
| <b>YATO</b>  | L (cm) |  |
| YT-86808  | 120    | 6   |

GB Digging fork  
D Profi-grabegabel  
PL Widły  
RUSВилы  
CZ Zahradnické vidlice  
H Vasvilla  
RO Furcă pt. grădinărit  
F Fourche à bêcher  
I Forchetta  
E Horca  
CN 铁叉

120  
cm

65 Mn  
STEEL





|   |        |   |
|---|--------|---|
| <b>YATO</b>  | L (cm) |  |
| YT-8603   | 120    | 3   |

GB Digging fork  
D Profi-grabegabel  
PL Widły  
RUSВилы  
CZ Zahradnické vidlice  
H Vasvilla  
RO Furcă pt. grădinărit  
F Fourche à bêcher  
I Forchetta  
E Horca  
CN 铁叉

120  
cm





|   |        |  |
|---|--------|--|
| <b>YATO</b>  | L (cm) |  |
| YT-86805  | 120    | 6  |

GB Digging fork  
D Profi-grabegabel  
PL Widły  
RUSВилы  
CZ Zahradnické vidlice  
H Vasvilla  
RO Furcă pt. grădinărit  
F Fourche à bêcher  
I Forchetta  
E Horca  
CN 铁叉

120  
cm



|   |        |   |
|---|--------|---|
| <b>YATO</b>  | L (cm) |  |
| YT-86809  | 120    | 6   |

| YATO     | page/strona | YATO     | page/strona | YATO     | page/strona | YATO     | page/strona | YATO     | page/strona | YATO     | page/strona | YATO     | page/strona | YATO     | page/strona |
|----------|-------------|----------|-------------|----------|-------------|----------|-------------|----------|-------------|----------|-------------|----------|-------------|----------|-------------|
| YT-0006  | 7           | YT-0118  | 13          | YT-0204  | 9           | YT-0320  | 33          | YT-0380  | 12          | YT-0453  | 74          | YT-0501  | 116         | YT-06019 | 338         |
| YT-0007  | 7           | YT-0119  | 13          | YT-0205  | 9           | YT-0321  | 38          | YT-0381  | 12          | YT-0454  | 74          | YT-0502  | 116         | YT-0602  | 319         |
| YT-0008  | 7           | YT-0120  | 13          | YT-0206  | 9           | YT-0322  | 29          | YT-0383  | 14          | YT-0455  | 74          | YT-0503  | 116         | YT-0603  | 322         |
| YT-0009  | 7           | YT-0122  | 13          | YT-0207  | 15          | YT-0323  | 33          | YT-0384  | 14          | YT-0456  | 74          | YT-0504  | 116         | YT-0604  | 351         |
| YT-0010  | 7           | YT-0123  | 13          | YT-0208  | 9           | YT-0324  | 38          | YT-0385  | 14          | YT-0457  | 74          | YT-0505  | 116         | YT-0605  | 355         |
| YT-0011  | 7           | YT-0125  | 13          | YT-0209  | 15          | YT-0325  | 29          | YT-0386  | 14          | YT-0459  | 111         | YT-0506  | 116         | YT-0606  | 333         |
| YT-0012  | 7           | YT-0127  | 13          | YT-0211  | 15          | YT-0326  | 33          | YT-0387  | 14          | YT-0461  | 74          | YT-0507  | 116         | YT-0607  | 333         |
| YT-0013  | 7           | YT-0128  | 13          | YT-0213  | 15          | YT-0327  | 38          | YT-0388  | 14          | YT-0465  | 113         | YT-0508  | 116         | YT-0608  | 333         |
| YT-0014  | 7           | YT-0132  | 13          | YT-0215  | 15          | YT-0331  | 30          | YT-0389  | 14          | YT-0466  | 113         | YT-0509  | 116         | YT-0609  | 319         |
| YT-0015  | 7           | YT-0135  | 18          | YT-0217  | 15          | YT-03311 | 30          | YT-0390  | 14          | YT-0467  | 113         | YT-0511  | 117         | YT-0610  | 351         |
| YT-0016  | 7           | YT-0136  | 18          | YT-0219  | 15          | YT-0332  | 12          | YT-0391  | 14          | YT-0468  | 113         | YT-0512  | 117         | YT-0611  | 352         |
| YT-0017  | 7           | YT-0137  | 18          | YT-0222  | 15          | YT-0333  | 12          | YT-0392  | 14          | YT-0470  | 109         | YT-0519  | 117         | YT-0612  | 324         |
| YT-0018  | 7           | YT-0138  | 18          | YT-0223  | 15          | YT-0334  | 12          | YT-0394  | 14          | YT-04702 | 108         | YT-0520  | 70          | YT-0613  | 324         |
| YT-0019  | 7           | YT-01385 | 18          | YT-0227  | 15          | YT-0335  | 6           | YT-0396  | 15          | YT-0471  | 109         | YT-0521  | 70          | YT-0614  | 324         |
| YT-0020  | 7           | YT-0139  | 18          | YT-0228  | 15          | YT-0336  | 6           | YT-0398  | 15          | YT-04712 | 108         | YT-05211 | 70          | YT-0615  | 324         |
| YT-0021  | 7           | YT-0140  | 18          | YT-0232  | 15          | YT-0337  | 6           | YT-0400  | 112         | YT-0472  | 109         | YT-05212 | 70          | YT-06155 | 324         |
| YT-0022  | 7           | YT-0143  | 18          | YT-02330 | 15          | YT-0338  | 6           | YT-0404  | 108         | YT-04722 | 108         | YT-05213 | 70          | YT-06157 | 325         |
| YT-0023  | 7           | YT-0150  | 13          | YT-02331 | 15          | YT-0339  | 6           | YT-0405  | 108         | YT-0473  | 109         | YT-05214 | 70          | YT-0616  | 325         |
| YT-0024  | 7           | YT-0152  | 13          | YT-02332 | 15          | YT-0340  | 6           | YT-04051 | 108         | YT-0474  | 109         | YT-05215 | 70          | YT-06160 | 324         |
| YT-0025  | 7           | YT-0156  | 11          | YT-02333 | 15          | YT-0341  | 6           | YT-04052 | 108         | YT-04742 | 108         | YT-05220 | 70          | YT-06161 | 331         |
| YT-0026  | 7           | YT-0158  | 11          | YT-02334 | 15          | YT-0342  | 6           | YT-0406  | 108         | YT-0475  | 109         | YT-05221 | 70          | YT-0617  | 341         |
| YT-0027  | 7           | YT-0159  | 11          | YT-0248  | 16          | YT-0343  | 6           | YT-0407  | 108         | YT-04752 | 108         | YT-05222 | 70          | YT-0618  | 341         |
| YT-0028  | 7           | YT-0162  | 11          | YT-0250  | 16          | YT-0344  | 6           | YT-0408  | 108         | YT-0476  | 109         | YT-05223 | 70          | YT-0619  | 356         |
| YT-0030  | 7           | YT-0163  | 11          | YT-0252  | 16          | YT-0345  | 6           | YT-0409  | 108         | YT-04762 | 108         | YT-05224 | 70          | YT-0620  | 323         |
| YT-0032  | 7           | YT-0170  | 18          | YT-0256  | 10          | YT-0346  | 6           | YT-0410  | 112         | YT-0477  | 109         | YT-05225 | 70          | YT-06205 | 334         |
| YT-0036  | 7           | YT-0171  | 18          | YT-0272  | 11          | YT-0347  | 6           | YT-0411  | 112         | YT-04772 | 108         | YT-05226 | 70          | YT-0621  | 356         |
| YT-0038  | 7           | YT-0172  | 18          | YT-0276  | 11          | YT-0348  | 6           | YT-0412  | 112         | YT-0478  | 109         | YT-05227 | 70          | YT-0622  | 343         |
| YT-0041  | 7           | YT-0173  | 18          | YT-0279  | 11          | YT-0349  | 6           | YT-0413  | 112         | YT-04782 | 108         | YT-05228 | 70          | YT-0623  | 323         |
| YT-0046  | 7           | YT-0175  | 18          | YT-0280  | 11          | YT-0350  | 6           | YT-0414  | 112         | YT-0479  | 109         | YT-0530  | 19          | YT-0624  | 323         |
| YT-0050  | 7           | YT-0180  | 19          | YT-0284  | 18          | YT-0351  | 6           | YT-0415  | 112         | YT-04792 | 108         | YT-0534  | 349         | YT-0627  | 337         |
| YT-0055  | 7           | YT-0181  | 19          | YT-0286  | 18          | YT-0352  | 6           | YT-0416  | 112         | YT-0480  | 109         | YT-0539  | 337         | YT-06271 | 332         |
| YT-0060  | 7           | YT-0184  | 19          | YT-0287  | 18          | YT-0353  | 6           | YT-0417  | 112         | YT-0481  | 109         | YT-0540  | 337         | YT-06273 | 337         |
| YT-0062  | 7           | YT-0185  | 19          | YT-0290  | 29          | YT-0354  | 6           | YT-0418  | 112         | YT-04812 | 108         | YT-0546  | 114         | YT-0628  | 356         |
| YT-0065  | 7           | YT-0186  | 19          | YT-0291  | 33          | YT-0355  | 6           | YT-0419  | 112         | YT-0482  | 109         | YT-0560  | 117         | YT-06291 | 328         |
| YT-0067  | 7           | YT-0187  | 19          | YT-0292  | 38          | YT-0356  | 6           | YT-0420  | 112         | YT-04822 | 108         | YT-0561  | 117         | YT-0630  | 333         |
| YT-0075  | 7           | YT-0189  | 9           | YT-0293  | 29          | YT-0357  | 6           | YT-0421  | 346         | YT-0483  | 109         | YT-0562  | 117         | YT-06311 | 350         |
| YT-00760 | 6           | YT-0190  | 19          | YT-0294  | 33          | YT-0358  | 6           | YT-04211 | 346         | YT-04832 | 108         | YT-0563  | 117         | YT-0632  | 338         |
| YT-00761 | 6           | YT-01906 | 9           | YT-0295  | 38          | YT-0359  | 6           | YT-0430  | 74          | YT-0484  | 111         | YT-0585  | 323         | YT-0633  | 340         |
| YT-00762 | 6           | YT-01907 | 9           | YT-0297  | 30          | YT-0360  | 6           | YT-0431  | 74          | YT-0485  | 108         | YT-0590  | 322         | YT-0635  | 338         |
| YT-00763 | 6           | YT-01908 | 9           | YT-0298  | 34          | YT-0362  | 6           | YT-0432  | 74          | YT-0486  | 108         | YT-0591  | 322         | YT-0636  | 338         |
| YT-00764 | 6           | YT-01909 | 9           | YT-0299  | 39          | YT-0363  | 6           | YT-0433  | 74          | YT-0487  | 108         | YT-0593  | 89; 349     | YT-0637  | 338         |
| YT-00765 | 6           | YT-0191  | 9           | YT-0307  | 29          | YT-0365  | 6           | YT-0434  | 74          | YT-0488  | 111         | YT-0594  | 312         | YT-0638  | 326         |
| YT-00766 | 6           | YT-0192  | 9           | YT-0308  | 33          | YT-0367  | 12          | YT-0435  | 74          | YT-0489  | 111         | YT-0595  | 311         | YT-0639  | 334         |
| YT-00767 | 6           | YT-0193  | 9           | YT-0309  | 38          | YT-0368  | 12          | YT-0436  | 74          | YT-0490  | 111         | YT-0596  | 312         | YT-0640  | 320         |
| YT-00768 | 6           | YT-0194  | 9           | YT-0310  | 29          | YT-0369  | 12          | YT-0437  | 74          | YT-0491  | 111         | YT-0598  | 313         | YT-0641  | 320         |
| YT-00769 | 6           | YT-0195  | 9           | YT-0311  | 33          | YT-0370  | 12          | YT-0438  | 74          | YT-0492  | 111         | YT-0599  | 313         | YT-0642  | 325         |
| YT-0107  | 13          | YT-0196  | 9           | YT-0312  | 38          | YT-0371  | 12          | YT-0439  | 74          | YT-0493  | 111         | YT-0600  | 313         | YT-0643  | 357         |
| YT-0109  | 13          | YT-0197  | 9           | YT-0313  | 29          | YT-0372  | 12          | YT-0440  | 74          | YT-0494  | 111         | YT-0601  | 338         | YT-0644  | 357         |
| YT-0110  | 13          | YT-0198  | 9           | YT-0314  | 33          | YT-0373  | 12          | YT-0441  | 74          | YT-0495  | 111         | YT-06011 | 338         | YT-0645  | 334         |
| YT-0111  | 13          | YT-0199  | 9           | YT-0315  | 38          | YT-0374  | 12          | YT-0442  | 74          | YT-0496  | 111         | YT-06012 | 339         | YT-0646  | 335         |
| YT-0112  | 13          | YT-0200  | 9           | YT-0316  | 29          | YT-0375  | 12          | YT-0443  | 74          | YT-0497  | 111         | YT-06013 | 340         | YT-0647  | 335         |
| YT-0113  | 13          | YT-0201  | 9           | YT-0317  | 33          | YT-0376  | 12          | YT-0450  | 74          | YT-0498  | 111         | YT-06014 | 339         | YT-06475 | 337         |
| YT-0115  | 13          | YT-0202  | 9           | YT-0318  | 38          | YT-0377  | 12          | YT-0451  | 74          | YT-0499  | 111         | YT-06015 | 341         | YT-0648  | 336         |
| YT-0117  | 13          | YT-0203  | 9           | YT-0319  | 29          | YT-0378  | 12          | YT-0452  | 74          | YT-0500  | 116         | YT-06016 | 340         | YT-0650  | 335         |



| YATO     | page/strona | YATO     | page/strona | YATO     | page/strona | YATO     | page/strona | YATO     | page/strona | YATO    | page/strona | YATO     | page/strona | YATO     | page/strona |
|----------|-------------|----------|-------------|----------|-------------|----------|-------------|----------|-------------|---------|-------------|----------|-------------|----------|-------------|
| YT-0651  | 335         | YT-0708  | 316         | YT-0830  | 360         | YT-09061 | 300         | YT-09746 | 218; 280    | YT-1045 | 79          | YT-1129  | 81          | YT-1210  | 35          |
| YT-0652  | 335         | YT-0709  | 316         | YT-08305 | 361         | YT-0907  | 307         | YT-09747 | 218; 280    | YT-1046 | 79          | YT-1130  | 81          | YT-1211  | 35          |
| YT-0653  | 336         | YT-0710  | 316         | YT-0831  | 361         | YT-09071 | 307         | YT-09748 | 218; 280    | YT-1047 | 79          | YT-1132  | 81          | YT-1212  | 35          |
| YT-0657  | 333         | YT-07115 | 317         | YT-0835  | 361         | YT-09072 | 307         | YT-09749 | 218; 280    | YT-1048 | 79          | YT-1133  | 81          | YT-1213  | 35          |
| YT-0659  | 332         | YT-0712  | 317         | YT-0836  | 331         | YT-0908  | 307         | YT-09750 | 218; 280    | YT-1049 | 79          | YT-1134  | 81          | YT-1214  | 35          |
| YT-06590 | 332         | YT-0715  | 317         | YT-0837  | 331         | YT-0910  | 307         | YT-0976  | 280         | YT-1050 | 79          | YT-1135  | 81          | YT-1215  | 35          |
| YT-0660  | 359         | YT-0716  | 367         | YT-0838  | 327         | YT-09101 | 308         | YT-0977  | 280         | YT-1052 | 79          | YT-1136  | 81          | YT-1216  | 35          |
| YT-0661  | 360         | YT-0717  | 367         | YT-08380 | 326         | YT-09102 | 308         | YT-0980  | 279         | YT-1054 | 79          | YT-1138  | 81          | YT-1217  | 35          |
| YT-06611 | 360         | YT-0718  | 367         | YT-08385 | 327         | YT-09107 | 308         | YT-0981  | 279         | YT-1055 | 79          | YT-1141  | 81          | YT-1218  | 35          |
| YT-0662  | 360         | YT-0720  | 30          | YT-0840  | 348         | YT-09108 | 308         | YT-0982  | 279         | YT-1056 | 357         | YT-1142  | 81          | YT-1219  | 35          |
| YT-0663  | 359         | YT-0722  | 39          | YT-0841  | 330         | YT-0911  | 307         | YT-0990  | 281         | YT-1060 | 80          | YT-1143  | 81          | YT-1220  | 35          |
| YT-0670  | 344         | YT-0726  | 358         | YT-0842  | 330         | YT-0912  | 298         | YT-0993  | 281         | YT-1061 | 80          | YT-1146  | 81          | YT-1221  | 36          |
| YT-0671  | 353         | YT-0730  | 30          | YT-0843  | 95          | YT-0913  | 298         | YT-0994  | 281         | YT-1062 | 80          | YT-1148  | 81          | YT-1222  | 36          |
| YT-0672  | 347         | YT-0731  | 34          | YT-08430 | 328         | YT-0914  | 298         | YT-1000  | 78          | YT-1064 | 80          | YT-1150  | 81          | YT-1223  | 36          |
| YT-06722 | 369         | YT-0732  | 39          | YT-0844  | 331         | YT-09151 | 296         | YT-1001  | 78          | YT-1065 | 84          | YT-1155  | 82          | YT-1224  | 36          |
| YT-0673  | 348         | YT-0733  | 30          | YT-0845  | 332         | YT-09152 | 296         | YT-1002  | 78          | YT-1066 | 84          | YT-1157  | 84          | YT-1225  | 36          |
| YT-0674  | 348         | YT-0734  | 34          | YT-0846  | 332         | YT-09155 | 296         | YT-1003  | 78          | YT-1067 | 80          | YT-1160  | 82          | YT-1226  | 36          |
| YT-0677  | 336         | YT-0735  | 39          | YT-0847  | 331         | YT-0920  | 240; 287    | YT-1004  | 78          | YT-1068 | 84          | YT-1161  | 82          | YT-1227  | 36          |
| YT-0680  | 351         | YT-0750  | 88          | YT-08502 | 362; 435    | YT-0921  | 240; 287    | YT-1005  | 78          | YT-1069 | 84          | YT-1162  | 82          | YT-1228  | 36          |
| YT-0681  | 352         | YT-0751  | 88          | YT-08503 | 364; 437    | YT-0923  | 240; 287    | YT-1006  | 78          | YT-1070 | 81          | YT-1163  | 82          | YT-1229  | 36          |
| YT-0682  | 353         | YT-0754  | 88          | YT-08505 | 363; 436    | YT-0925  | 241; 287    | YT-1007  | 78          | YT-1071 | 81          | YT-1164  | 82          | YT-1230  | 36          |
| YT-06822 | 354         | YT-0755  | 88          | YT-08513 | 362; 435    | YT-0927  | 241         | YT-1008  | 78          | YT-1072 | 81          | YT-11671 | 82          | YT-1231  | 36          |
| YT-0683  | 351         | YT-0760  | 88          | YT-08514 | 362; 435    | YT-0929  | 241         | YT-1009  | 78          | YT-1073 | 81          | YT-1168  | 82          | YT-1232  | 36          |
| YT-0684  | 350         | YT-0761  | 88          | YT-0852  | 363; 436    | YT-0930  | 241         | YT-1010  | 78          | YT-1074 | 81          | YT-1169  | 83          | YT-1233  | 36          |
| YT-0685  | 350         | YT-0770  | 88          | YT-08523 | 363; 436    | YT-0931  | 241         | YT-1011  | 78          | YT-1075 | 81          | YT-1175  | 83          | YT-1234  | 36          |
| YT-0686  | 350         | YT-0771  | 88          | YT-08530 | 364; 437    | YT-0932  | 241         | YT-1012  | 78          | YT-1076 | 81          | YT-1176  | 83          | YT-1235  | 36          |
| YT-06871 | 376         | YT-0781  | 89          | YT-08531 | 363; 436    | YT-0935  | 241         | YT-1013  | 78          | YT-1077 | 81          | YT-1177  | 83          | YT-1236  | 36          |
| YT-06877 | 376         | YT-0782  | 89          | YT-08561 | 362; 435    | YT-0936  | 241         | YT-1014  | 78          | YT-1078 | 81          | YT-1178  | 83          | YT-1237  | 36          |
| YT-06880 | 377         | YT-07822 | 89          | YT-0860  | 360         | YT-0937  | 241         | YT-1015  | 78          | YT-1079 | 81          | YT-1179  | 83          | YT-1238  | 36          |
| YT-06881 | 377         | YT-0795  | 357         | YT-0862  | 168; 385    | YT-0938  | 241         | YT-1016  | 78          | YT-1080 | 81          | YT-1180  | 83          | YT-1239  | 36          |
| YT-06888 | 376         | YT-0796  | 357         | YT-0863  | 168; 385    | YT-0939  | 241         | YT-1017  | 78          | YT-1082 | 81          | YT-1182  | 83          | YT-1240  | 36          |
| YT-0690  | 317         | YT-0800  | 358         | YT-0864  | 168; 385    | YT-0940  | 241         | YT-1018  | 78          | YT-1083 | 81          | YT-1183  | 83          | YT-1241  | 37          |
| YT-0691  | 317         | YT-0801  | 358         | YT-0865  | 168; 385    | YT-0941  | 241         | YT-1019  | 78          | YT-1084 | 81          | YT-1184  | 83          | YT-1242  | 37          |
| YT-06912 | 317         | YT-0802  | 358         | YT-0866  | 168; 385    | YT-0942  | 241         | YT-1020  | 78          | YT-1085 | 81          | YT-1185  | 83          | YT-1243  | 37          |
| YT-06913 | 317         | YT-0803  | 358         | YT-0867  | 168; 385    | YT-09501 | 276         | YT-1022  | 78          | YT-1086 | 81          | YT-1186  | 83          | YT-1244  | 37          |
| YT-06914 | 317         | YT-0807  | 358         | YT-0870  | 168; 385    | YT-09505 | 276         | YT-1025  | 78          | YT-1088 | 81          | YT-1187  | 83          | YT-1246  | 36          |
| YT-0692  | 367         | YT-0808  | 358         | YT-0880  | 361         | YT-09511 | 276         | YT-1027  | 84          | YT-1091 | 81          | YT-1188  | 83          | YT-1247  | 36          |
| YT-0693  | 367         | YT-0809  | 358         | YT-0882  | 309         | YT-0952  | 276         | YT-1028  | 84          | YT-1092 | 81          | YT-1189  | 83          | YT-1248  | 36          |
| YT-0694  | 367         | YT-0810  | 358         | YT-0883  | 309         | YT-0953  | 277         | YT-1029  | 84          | YT-1093 | 81          | YT-1191  | 83          | YT-1249  | 36          |
| YT-0695  | 367         | YT-0811  | 358         | YT-0884  | 309         | YT-09540 | 277         | YT-1030  | 79          | YT-1096 | 81          | YT-1193  | 83          | YT-1250  | 36          |
| YT-0696  | 367         | YT-0812  | 349         | YT-0885  | 309         | YT-0956  | 277         | YT-1031  | 79          | YT-1098 | 81          | YT-1194  | 83          | YT-1251  | 36          |
| YT-0697  | 367         | YT-0813  | 350         | YT-0886  | 309         | YT-09571 | 277         | YT-1032  | 79          | YT-1100 | 81          | YT-1195  | 83          | YT-1252  | 37          |
| YT-0699  | 367         | YT-0814  | 350         | YT-08920 | 300         | YT-0959  | 278         | YT-1033  | 79          | YT-1102 | 81          | YT-1196  | 83          | YT-1253  | 37; 349     |
| YT-0700  | 314         | YT-0817  | 349         | YT-08921 | 306         | YT-0960  | 278         | YT-1034  | 79          | YT-1105 | 81          | YT-1197  | 83          | YT-1254  | 37; 349     |
| YT-0701  | 314         | YT-0818  | 349         | YT-08922 | 306         | YT-09611 | 278         | YT-1035  | 79          | YT-1110 | 81          | YT-1198  | 83          | YT-1255  | 37          |
| YT-0704  | 315         | YT-0819  | 349         | YT-09000 | 299         | YT-0965  | 279         | YT-1036  | 79          | YT-1115 | 81          | YT-1201  | 35          | YT-1258  | 37          |
| YT-07041 | 315         | YT-0820  | 311         | YT-09001 | 297         | YT-0967  | 279         | YT-1037  | 79          | YT-1119 | 81          | YT-1202  | 35          | YT-1259  | 37          |
| YT-07042 | 314         | YT-0821  | 311         | YT-09002 | 297         | YT-0970  | 281         | YT-1038  | 79          | YT-1121 | 81          | YT-1203  | 35          | YT-12621 | 57          |
| YT-07043 | 314         | YT-0822  | 311         | YT-09003 | 297         | YT-09702 | 281         | YT-1039  | 79          | YT-1122 | 81          | YT-1204  | 35          | YT-12641 | 58          |
| YT-0705  | 314         | YT-0823  | 311         | YT-09008 | 299         | YT-09741 | 280         | YT-1040  | 79          | YT-1123 | 81          | YT-1205  | 35          | YT-12651 | 58          |
| YT-07055 | 286; 315    | YT-0824  | 311         | YT-0902  | 298         | YT-09742 | 280         | YT-1041  | 79          | YT-1124 | 81          | YT-1206  | 35          | YT-12661 | 58          |
| YT-07061 | 316         | YT-0825  | 311         | YT-0903  | 298         | YT-09743 | 218; 280    | YT-1042  | 79          | YT-1125 | 81          | YT-1207  | 35          | YT-12671 | 58          |
| YT-07063 | 316         | YT-0826  | 311         | YT-09031 | 299         | YT-09744 | 218; 280    | YT-1043  | 79          | YT-1127 | 81          | YT-1208  | 35          | YT-1268  | 63          |
| YT-0707  | 316         | YT-08295 | 360         | YT-0904  | 299         | YT-09745 | 218; 280    | YT-1044  | 79          | YT-1128 | 81          | YT-1209  | 35          | YT-12681 | 44          |

| YATO     | page/strom | YATO     | page/strom | YATO     | page/strom | YATO    | page/strom | YATO    | page/strom | YATO     | page/strom | YATO     | page/strom    | YATO     | page/strom |
|----------|------------|----------|------------|----------|------------|---------|------------|---------|------------|----------|------------|----------|---------------|----------|------------|
| YT-12682 | 64         | YT-1340  | 71         | YT-1429  | 27         | YT-1515 | 113        | YT-1604 | 17         | YT-1665  | 10         | YT-1767  | 183; 365      | YT-1949  | 128        |
| YT-1269  | 63         | YT-1341  | 71         | YT-1430  | 27         | YT-1517 | 113        | YT-1605 | 17         | YT-1666  | 10         | YT-1768  | 183; 365      | YT-1950  | 127        |
| YT-12691 | 44         | YT-1342  | 71         | YT-1431  | 27         | YT-1518 | 113        | YT-1606 | 17         | YT-1667  | 10         | YT-1769  | 183; 365      | YT-1951  | 127        |
| YT-1270  | 35         | YT-1345  | 72         | YT-1432  | 27         | YT-1530 | 113        | YT-1607 | 17         | YT-1668  | 10         | YT-1781  | 78            | YT-1952  | 127        |
| YT-1271  | 35         | YT-1347  | 72         | YT-1433  | 27         | YT-1531 | 113        | YT-1608 | 17         | YT-1669  | 10         | YT-1792  | 78            | YT-1953  | 127        |
| YT-1272  | 35         | YT-1348  | 72         | YT-1434  | 27         | YT-1532 | 113        | YT-1609 | 17         | YT-1670  | 10         | YT-1795  | 78            | YT-1954  | 127        |
| YT-1273  | 35         | YT-1350  | 71         | YT-1435  | 27         | YT-1533 | 113        | YT-1610 | 17         | YT-1671  | 10         | YT-1797  | 78            | YT-1956  | 127        |
| YT-1274  | 35         | YT-1352  | 71         | YT-1436  | 27         | YT-1534 | 113        | YT-1611 | 17         | YT-1672  | 10         | YT-1799  | 78            | YT-1960  | 190; 386   |
| YT-1275  | 35         | YT-1355  | 71         | YT-1437  | 28         | YT-1535 | 113        | YT-1612 | 17         | YT-1673  | 10         | YT-1843  | 192           | YT-1961  | 190; 387   |
| YT-1276  | 35         | YT-1356  | 37         | YT-1438  | 28         | YT-1537 | 113        | YT-1613 | 17         | YT-1674  | 11         | YT-1844  | 192           | YT-1962  | 190; 386   |
| YT-1277  | 35         | YT-1360  | 72         | YT-14411 | 51         | YT-1539 | 113        | YT-1614 | 17         | YT-1675  | 11         | YT-1845  | 192           | YT-1963  | 189; 388   |
| YT-1278  | 35         | YT-1370  | 329        | YT-14421 | 51         | YT-1541 | 21         | YT-1615 | 17         | YT-1676  | 11         | YT-1846  | 192           | YT-1964  | 189; 388   |
| YT-1279  | 35         | YT-1371  | 329        | YT-1443  | 51         | YT-1542 | 21         | YT-1616 | 17         | YT-1677  | 11         | YT-1847  | 192           | YT-1965  | 189; 388   |
| YT-1280  | 35         | YT-1372  | 329        | YT-1444  | 52         | YT-1543 | 21         | YT-1617 | 17         | YT-1678  | 11         | YT-1848  | 192           | YT-1966  | 147; 189   |
| YT-1281  | 35         | YT-1373  | 329        | YT-1445  | 52         | YT-1544 | 21         | YT-1618 | 17         | YT-1679  | 11         | YT-1851  | 192           | YT-1967  | 147; 189   |
| YT-1282  | 35         | YT-1374  | 329        | YT-14451 | 40         | YT-1545 | 21         | YT-1619 | 17         | YT-1680  | 11         | YT-1852  | 192           | YT-1968  | 147; 189   |
| YT-1283  | 35         | YT-1375  | 329        | YT-1446  | 53         | YT-1546 | 21         | YT-1620 | 17         | YT-1681  | 11         | YT-1853  | 192           | YT-1969  | 147; 189   |
| YT-1284  | 35         | YT-1376  | 329        | YT-14461 | 40         | YT-1547 | 21         | YT-1621 | 17         | YT-1682  | 11         | YT-1854  | 192           | YT-1970  | 189; 388   |
| YT-1285  | 35         | YT-1378  | 329        | YT-1447  | 53         | YT-1548 | 21         | YT-1622 | 17         | YT-1683  | 11         | YT-1855  | 192           | YT-1974  | 146; 207   |
| YT-1286  | 35         | YT-1379  | 329        | YT-14471 | 40         | YT-1549 | 21         | YT-1627 | 19         | YT-1684  | 11         | YT-1856  | 192           | YT-1976  | 193        |
| YT-1289  | 35         | YT-13790 | 329        | YT-1448  | 53         | YT-1552 | 22         | YT-1628 | 19         | YT-1685  | 11         | YT-18600 | 147; 193      | YT-19763 | 207        |
| YT-1291  | 35         | YT-1381  | 329        | YT-14481 | 41         | YT-1553 | 22         | YT-1629 | 19         | YT-1686  | 11         | YT-18602 | 147; 193      | YT-19764 | 207        |
| YT-1292  | 35         | YT-1382  | 330        | YT-1449  | 52         | YT-1554 | 22         | YT-1630 | 19         | YT-1687  | 11         | YT-18610 | 147; 193      | YT-19765 | 207        |
| YT-1295  | 37         | YT-1385  | 330        | YT-1450  | 54         | YT-1555 | 22         | YT-1631 | 19         | YT-1688  | 11         | YT-18611 | 147; 193      | YT-19766 | 207        |
| YT-1296  | 32         | YT-1390  | 330        | YT-14501 | 41         | YT-1556 | 22         | YT-1632 | 19         | YT-1689  | 11         | YT-18612 | 147; 193      | YT-19767 | 207        |
| YT-1297  | 28         | YT-1391  | 330        | YT-1460  | 35         | YT-1557 | 22         | YT-1633 | 19         | YT-1690  | 11         | YT-1900  | 191; 256; 387 | YT-1988  | 130        |
| YT-1301  | 71         | YT-1392  | 330        | YT-1461  | 35         | YT-1558 | 22         | YT-1634 | 19         | YT-1691  | 11         | YT-1901  | 191; 256; 387 | YT-1989  | 130        |
| YT-1302  | 71         | YT-1400  | 28         | YT-1462  | 35         | YT-1559 | 22         | YT-1635 | 19         | YT-1692  | 11         | YT-1902  | 191; 256; 387 | YT-1990  | 130        |
| YT-1303  | 71         | YT-1401  | 27         | YT-1463  | 35         | YT-1565 | 22         | YT-1636 | 19         | YT-1694  | 11         | YT-1910  | 190; 386      | YT-1991  | 130        |
| YT-1304  | 71         | YT-1403  | 27         | YT-1464  | 35         | YT-1566 | 22         | YT-1637 | 19         | YT-1696  | 11         | YT-1911  | 190; 387      | YT-1992  | 130        |
| YT-1305  | 71         | YT-1404  | 27         | YT-1465  | 35         | YT-1567 | 22         | YT-1638 | 19         | YT-1702  | 368        | YT-1912  | 190; 386      | YT-1993  | 130        |
| YT-1306  | 71         | YT-1405  | 27         | YT-1466  | 35         | YT-1571 | 22         | YT-1639 | 19         | YT-1704  | 368        | YT-1913  | 191; 256; 386 | YT-1994  | 130        |
| YT-1307  | 71         | YT-1406  | 27         | YT-1467  | 35         | YT-1572 | 22         | YT-1640 | 19         | YT-1706  | 368        | YT-1914  | 191; 256; 387 | YT-1995  | 130        |
| YT-1308  | 71         | YT-1407  | 27         | YT-1468  | 35         | YT-1573 | 22         | YT-1641 | 19         | YT-1707  | 368        | YT-1915  | 190; 386      | YT-2006  | 121        |
| YT-1309  | 71         | YT-1408  | 27         | YT-1469  | 35         | YT-1574 | 22         | YT-1642 | 19         | YT-1709  | 368        | YT-1916  | 190; 387      | YT-2007  | 121        |
| YT-1310  | 71         | YT-1409  | 27         | YT-1470  | 35         | YT-1575 | 22         | YT-1643 | 19         | YT-1711  | 368        | YT-1918  | 190; 386      | YT-2008  | 121        |
| YT-1311  | 71         | YT-1410  | 27         | YT-1471  | 35         | YT-1576 | 22         | YT-1644 | 19         | YT-1713  | 368        | YT-1919  | 190; 387      | YT-2016  | 121        |
| YT-1312  | 71         | YT-1411  | 27         | YT-1472  | 35         | YT-1577 | 22         | YT-1647 | 19         | YT-1714  | 368        | YT-1920  | 191; 388      | YT-2018  | 121        |
| YT-1313  | 71         | YT-1412  | 27         | YT-1473  | 35         | YT-1578 | 22         | YT-1649 | 19         | YT-1715  | 368        | YT-1922  | 190; 386      | YT-2026  | 121        |
| YT-1314  | 71         | YT-1413  | 27         | YT-1474  | 35         | YT-1586 | 22         | YT-1650 | 19         | YT-1719  | 369        | YT-1923  | 190; 386      | YT-2028  | 121        |
| YT-1315  | 71         | YT-1414  | 27         | YT-1475  | 35         | YT-1588 | 79         | YT-1651 | 10         | YT-1720  | 369        | YT-1924  | 191; 388      | YT-2029  | 122        |
| YT-1316  | 71         | YT-1415  | 27         | YT-1476  | 35         | YT-1589 | 79         | YT-1652 | 10         | YT-1721  | 369        | YT-1925  | 191; 256; 388 | YT-2030  | 122        |
| YT-1317  | 71         | YT-1416  | 27         | YT-1478  | 35         | YT-1590 | 79         | YT-1653 | 10         | YT-1751  | 342        | YT-1930  | 192; 389      | YT-2031  | 122        |
| YT-1318  | 71         | YT-1417  | 27         | YT-1480  | 35         | YT-1591 | 79         | YT-1654 | 10         | YT-1752  | 342        | YT-1933  | 147; 189      | YT-2036  | 121        |
| YT-1319  | 71         | YT-1418  | 27         | YT-1481  | 35         | YT-1592 | 79         | YT-1655 | 10         | YT-1753  | 342        | YT-1939  | 192; 257; 389 | YT-2037  | 121        |
| YT-1320  | 71         | YT-1419  | 27         | YT-1501  | 113        | YT-1593 | 79         | YT-1656 | 10         | YT-1754  | 342        | YT-1940  | 121           | YT-2039  | 128        |
| YT-1322  | 71         | YT-1420  | 27         | YT-1502  | 113        | YT-1594 | 79         | YT-1657 | 10         | YT-1756  | 342        | YT-1941  | 121           | YT-2046  | 128        |
| YT-1323  | 71         | YT-1421  | 27         | YT-1503  | 113        | YT-1596 | 79         | YT-1658 | 10         | YT-1757  | 313        | YT-1942  | 121           | YT-2047  | 128        |
| YT-1324  | 71         | YT-1422  | 27         | YT-1505  | 113        | YT-1598 | 79         | YT-1659 | 10         | YT-1762  | 343        | YT-1943  | 121           | YT-2048  | 128        |
| YT-1326  | 71         | YT-1423  | 27         | YT-1507  | 113        | YT-1599 | 79         | YT-1660 | 10         | YT-17625 | 343        | YT-1944  | 121           | YT-2050  | 128        |
| YT-1328  | 71         | YT-1424  | 27         | YT-1508  | 113        | YT-1600 | 93         | YT-1661 | 10         | YT-1763  | 183; 365   | YT-1945  | 121           | YT-2051  | 128        |
| YT-1330  | 71         | YT-1425  | 28         | YT-1511  | 113        | YT-1601 | 17         | YT-1662 | 10         | YT-1764  | 183; 365   | YT-1946  | 121           | YT-2052  | 128        |
| YT-1334  | 72         | YT-1426  | 28         | YT-1512  | 113        | YT-1602 | 17         | YT-1663 | 10         | YT-1765  | 183; 365   | YT-1947  | 121           | YT-2055  | 128        |
| YT-1335  | 72         | YT-1427  | 28         | YT-1513  | 113        | YT-1603 | 17         | YT-1664 | 10         | YT-1766  | 183; 365   | YT-1948  | 121           | YT-2056  | 128        |



| YATO     | page/strona | YATO     | page/strona | YATO     | page/strona | YATO     | page/strona | YATO     | page/strona | YATO     | page/strona | YATO     | page/strona | YATO    | page/strona |
|----------|-------------|----------|-------------|----------|-------------|----------|-------------|----------|-------------|----------|-------------|----------|-------------|---------|-------------|
| YT-2057  | 128         | YT-2162  | 133; 383    | YT-2233  | 210; 228    | YT-22930 | 144         | YT-24301 | 366         | YT-2571  | 106         | YT-25920 | 97          | YT-2601 | 101         |
| YT-2058  | 128         | YT-2163  | 133; 383    | YT-22338 | 210; 228    | YT-2294  | 144         | YT-2449  | 131         | YT-2575  | 96          | YT-25921 | 97          | YT-2602 | 101         |
| YT-2060  | 128         | YT-2165  | 23          | YT-2234  | 210; 228    | YT-2295  | 144         | YT-2450  | 131         | YT-2576  | 96          | YT-25922 | 97          | YT-2603 | 101         |
| YT-2061  | 128         | YT-21650 | 23          | YT-2235  | 210; 228    | YT-2296  | 140         | YT-2451  | 131         | YT-2577  | 96          | YT-25923 | 97          | YT-2604 | 101         |
| YT-2063  | 128         | YT-21651 | 23          | YT-22353 | 209; 227    | YT-2297  | 141         | YT-2452  | 131         | YT-25802 | 103         | YT-25924 | 97          | YT-2606 | 101         |
| YT-2064  | 128         | YT-21652 | 23          | YT-22354 | 209; 227    | YT-2298  | 141         | YT-2453  | 131         | YT-25803 | 103         | YT-25925 | 97          | YT-2607 | 101         |
| YT-2066  | 122         | YT-21653 | 23          | YT-22355 | 209; 227    | YT-2299  | 141         | YT-2459  | 131         | YT-25804 | 103         | YT-25926 | 97          | YT-2608 | 101         |
| YT-2067  | 122         | YT-21654 | 23          | YT-22360 | 232         | YT-2300  | 140         | YT-2460  | 131         | YT-25805 | 103         | YT-25927 | 97          | YT-2609 | 101         |
| YT-2069  | 134; 226    | YT-2166  | 23          | YT-22361 | 232         | YT-2301  | 141         | YT-2461  | 132; 383    | YT-25806 | 103         | YT-25928 | 97          | YT-2610 | 101         |
| YT-2070  | 134; 226    | YT-2167  | 23          | YT-2240  | 142         | YT-2302  | 141         | YT-2463  | 132; 383    | YT-25807 | 103         | YT-25929 | 97          | YT-2612 | 101         |
| YT-2071  | 23          | YT-2168  | 23          | YT-2242  | 142         | YT-2305  | 142         | YT-2466  | 132; 384    | YT-25808 | 103         | YT-25930 | 97          | YT-2613 | 101         |
| YT-2072  | 23          | YT-2170  | 23          | YT-22422 | 142         | YT-2307  | 141         | YT-2468  | 132; 384    | YT-25809 | 103         | YT-25931 | 97          | YT-2614 | 101         |
| YT-2073  | 23          | YT-2171  | 23          | YT-2243  | 142         | YT-2313  | 145         | YT-2469  | 132; 384    | YT-25810 | 103         | YT-25932 | 97          | YT-2615 | 101         |
| YT-2074  | 23          | YT-2172  | 23          | YT-2244  | 142         | YT-2316  | 145         | YT-2473  | 132         | YT-25811 | 103         | YT-25933 | 97          | YT-2618 | 101         |
| YT-2075  | 23          | YT-2173  | 23          | YT-2245  | 140         | YT-2319  | 144         | YT-2476  | 132         | YT-25831 | 103         | YT-25934 | 97          | YT-2619 | 101         |
| YT-2080  | 124         | YT-2180  | 229         | YT-2246  | 140         | YT-2340  | 282         | YT-2482  | 134; 225    | YT-25832 | 103         | YT-25940 | 97          | YT-2620 | 92          |
| YT-2081  | 124         | YT-2182  | 229         | YT-2247  | 141         | YT-2341  | 282         | YT-2483  | 134; 225    | YT-25833 | 103         | YT-25941 | 97          | YT-2621 | 92          |
| YT-2082  | 124         | YT-21840 | 229         | YT-2249  | 141         | YT-2346  | 282         | YT-2484  | 134; 225    | YT-25834 | 103         | YT-25942 | 97          | YT-2622 | 92          |
| YT-2083  | 124         | YT-21842 | 229         | YT-2250  | 140         | YT-2357  | 282         | YT-2485  | 134; 225    | YT-25835 | 103         | YT-25943 | 97          | YT-2623 | 92          |
| YT-2084  | 124         | YT-21843 | 229         | YT-2251  | 141         | YT-2370  | 282         | YT-2488  | 134; 225    | YT-25836 | 103         | YT-25950 | 97          | YT-2624 | 92          |
| YT-2085  | 124         | YT-21844 | 229         | YT-2254  | 143         | YT-2371  | 282         | YT-2489  | 134; 225    | YT-25837 | 103         | YT-25951 | 97          | YT-2625 | 92          |
| YT-2086  | 124         | YT-21845 | 229         | YT-2255  | 140         | YT-2372  | 282         | YT-2490  | 134; 225    | YT-25838 | 103         | YT-25952 | 97          | YT-2626 | 92          |
| YT-2090  | 134; 226    | YT-21846 | 229         | YT-2256  | 140         | YT-2373  | 283         | YT-2491  | 134; 225    | YT-25839 | 103         | YT-25953 | 97          | YT-2627 | 92          |
| YT-2091  | 134; 226    | YT-2201  | 134; 225    | YT-2260  | 146         | YT-2374  | 283         | YT-2492  | 134; 225    | YT-25840 | 103         | YT-25954 | 97          | YT-2628 | 92          |
| YT-20911 | 134; 226    | YT-2203  | 134; 225    | YT-2261  | 146         | YT-2375  | 283         | YT-2493  | 134; 225    | YT-25841 | 103         | YT-25955 | 97          | YT-2629 | 92          |
| YT-2101  | 126; 139    | YT-2204  | 134; 225    | YT-2262  | 146         | YT-2376  | 283         | YT-2494  | 134; 225    | YT-25842 | 103         | YT-25956 | 97          | YT-2630 | 92          |
| YT-2102  | 126; 139    | YT-2205  | 134; 225    | YT-2263  | 146         | YT-2380  | 284         | YT-2510  | 319         | YT-25843 | 103         | YT-25957 | 97          | YT-2631 | 92          |
| YT-2103  | 126; 139    | YT-2206  | 134; 225    | YT-2266  | 143         | YT-2381  | 284         | YT-25105 | 319         | YT-25844 | 103         | YT-25958 | 97          | YT-2633 | 101         |
| YT-2104  | 126; 139    | YT-2210  | 226         | YT-2267  | 143         | YT-2382  | 284         | YT-2511  | 318         | YT-25845 | 103         | YT-25959 | 97          | YT-2634 | 101         |
| YT-2105  | 126; 139    | YT-2211  | 226         | YT-2268  | 145         | YT-2383  | 284         | YT-2512  | 318         | YT-25846 | 103         | YT-25960 | 97          | YT-2635 | 101         |
| YT-2107  | 126; 139    | YT-2212  | 226         | YT-2270  | 145         | YT-2384  | 284         | YT-2513  | 318         | YT-25852 | 103         | YT-25961 | 97          | YT-2636 | 101         |
| YT-2109  | 126; 139    | YT-2213  | 226         | YT-2271  | 143         | YT-2385  | 284         | YT-2514  | 318         | YT-25853 | 103         | YT-25965 | 98          | YT-2637 | 101         |
| YT-2110  | 126; 139    | YT-2214  | 226         | YT-2272  | 144         | YT-2390  | 285         | YT-2515  | 318         | YT-25854 | 103         | YT-25966 | 99          | YT-2638 | 101         |
| YT-2112  | 126; 139    | YT-2215  | 226         | YT-2273  | 144         | YT-2391  | 285         | YT-2516  | 318         | YT-25855 | 103         | YT-25967 | 99          | YT-2639 | 101         |
| YT-2130  | 129         | YT-2216  | 226         | YT-2274  | 145         | YT-2392  | 285         | YT-2517  | 318         | YT-25856 | 103         | YT-25968 | 100         | YT-2640 | 101         |
| YT-2136  | 129         | YT-2217  | 226         | YT-2275  | 145         | YT-2393  | 285         | YT-2518  | 318         | YT-25857 | 103         | YT-25971 | 99          | YT-2641 | 101         |
| YT-2137  | 129         | YT-2218  | 226         | YT-2276  | 145         | YT-2394  | 285         | YT-2519  | 318         | YT-25861 | 103         | YT-25972 | 106         | YT-2642 | 101         |
| YT-2138  | 129         | YT-2222  | 134; 225    | YT-2277  | 143         | YT-2395  | 285         | YT-2520  | 318         | YT-25862 | 103         | YT-25980 | 98          | YT-2643 | 101         |
| YT-2139  | 129         | YT-2223  | 134; 225    | YT-2278  | 145         | YT-2396  | 285         | YT-2521  | 318         | YT-25863 | 103         | YT-25981 | 99          | YT-2644 | 101         |
| YT-2140  | 130         | YT-2224  | 134; 225    | YT-2279  | 146         | YT-2397  | 285         | YT-2522  | 318         | YT-25900 | 97          | YT-25982 | 100         | YT-2645 | 101         |
| YT-2141  | 130         | YT-2225  | 134; 225    | YT-2280  | 146         | YT-2398  | 285         | YT-2523  | 318         | YT-25901 | 97          | YT-25985 | 98          | YT-2647 | 101         |
| YT-2142  | 130         | YT-22260 | 134; 226    | YT-2283  | 141         | YT-2399  | 285         | YT-2535  | 355         | YT-25902 | 97          | YT-25986 | 98          | YT-2648 | 101         |
| YT-2143  | 130         | YT-2228  | 209; 227    | YT-22860 | 143         | YT-2401  | 285         | YT-2536  | 355         | YT-25903 | 97          | YT-25987 | 98          | YT-2649 | 101         |
| YT-2144  | 130         | YT-2229  | 209; 227    | YT-22861 | 143         | YT-2402  | 285         | YT-2537  | 355         | YT-25904 | 97          | YT-25988 | 98          | YT-2650 | 101         |
| YT-2145  | 130         | YT-2230  | 209; 227    | YT-22862 | 143         | YT-2403  | 285         | YT-2538  | 350         | YT-25905 | 97          | YT-25989 | 98          | YT-2653 | 101         |
| YT-2146  | 130         | YT-2231  | 209; 227    | YT-22870 | 193         | YT-2404  | 285         | YT-2539  | 321         | YT-25906 | 97          | YT-25990 | 98          | YT-2654 | 101         |
| YT-2147  | 130         | YT-22312 | 209; 227    | YT-22871 | 193         | YT-2405  | 285         | YT-2540  | 321         | YT-25907 | 97          | YT-25991 | 98          | YT-2655 | 101         |
| YT-2151  | 131         | YT-22313 | 210; 228    | YT-22872 | 193         | YT-2406  | 285         | YT-2541  | 321         | YT-25908 | 97          | YT-25992 | 98          | YT-2656 | 101         |
| YT-2152  | 131         | YT-22314 | 210; 228    | YT-22873 | 193         | YT-2407  | 285         | YT-2542  | 322         | YT-25909 | 97          | YT-25993 | 98          | YT-2657 | 101         |
| YT-2153  | 131         | YT-22315 | 210; 228    | YT-22874 | 193         | YT-24091 | 285         | YT-2543  | 322         | YT-25910 | 97          | YT-25994 | 98          | YT-2658 | 101         |
| YT-2155  | 131         | YT-22316 | 210; 228    | YT-22875 | 193         | YT-24092 | 285         | YT-2544  | 355         | YT-25911 | 97          | YT-25995 | 98          | YT-2661 | 101         |
| YT-2156  | 131         | YT-22317 | 210; 228    | YT-2290  | 144         | YT-24093 | 285         | YT-2545  | 320         | YT-25912 | 97          | YT-25996 | 98          | YT-2663 | 101         |
| YT-2160  | 133; 383    | YT-22318 | 210; 228    | YT-2292  | 144         | YT-24094 | 285         | YT-2546  | 355         | YT-25913 | 97          | YT-25997 | 98          | YT-2665 | 101         |
| YT-2161  | 133; 383    | YT-2232  | 210; 228    | YT-2293  | 144         | YT-24095 | 285         | YT-2547  | 355         | YT-25914 | 97          | YT-25998 | 98          | YT-2667 | 101         |

| YATO    | page/strona | YATO    | page/strona | YATO     | page/strona | YATO    | page/strona | YATO    | page/strona | YATO    | page/strona   | YATO    | page/strona | YATO     | page/strona |
|---------|-------------|---------|-------------|----------|-------------|---------|-------------|---------|-------------|---------|---------------|---------|-------------|----------|-------------|
| YT-2668 | 102         | YT-2748 | 101         | YT-2817  | 104; 138    | YT-2917 | 224         | YT-2979 | 181         | YT-3200 | 194; 458; 460 | YT-3277 | 177         | YT-3372  | 179         |
| YT-2669 | 102         | YT-2750 | 101         | YT-2818  | 104; 138    | YT-2918 | 224         | YT-2980 | 182         | YT-3201 | 194; 458; 460 | YT-3278 | 177         | YT-3373  | 179         |
| YT-2670 | 102         | YT-2752 | 101         | YT-2819  | 104; 138    | YT-2919 | 224         | YT-2981 | 182         | YT-3202 | 194; 458; 460 | YT-3279 | 177         | YT-3374  | 179         |
| YT-2675 | 92          | YT-2753 | 101         | YT-2820  | 104; 138    | YT-2920 | 224         | YT-2982 | 182         | YT-3203 | 194; 458; 460 | YT-3280 | 177         | YT-3376  | 179         |
| YT-2676 | 92          | YT-2754 | 101         | YT-2821  | 104; 138    | YT-2921 | 224         | YT-2983 | 182         | YT-3204 | 194; 458; 460 | YT-3281 | 177         | YT-3377  | 179         |
| YT-2677 | 92          | YT-2756 | 101         | YT-2822  | 104; 138    | YT-2926 | 181         | YT-2984 | 182         | YT-3221 | 195; 458; 460 | YT-3282 | 177         | YT-3380  | 180         |
| YT-2678 | 92          | YT-2757 | 101         | YT-2823  | 104; 138    | YT-2927 | 181         | YT-2985 | 182         | YT-3222 | 195; 458; 460 | YT-3283 | 177         | YT-3381  | 180         |
| YT-2679 | 92          | YT-2760 | 92          | YT-2824  | 104; 138    | YT-2930 | 181         | YT-2986 | 182         | YT-3223 | 195; 458; 460 | YT-3284 | 177         | YT-3400  | 196         |
| YT-2682 | 92          | YT-2761 | 92          | YT-2825  | 104; 138    | YT-2931 | 181         | YT-2987 | 182         | YT-3224 | 195; 458; 460 | YT-3285 | 177         | YT-3401  | 196         |
| YT-2683 | 92          | YT-2762 | 92          | YT-2826  | 104; 138    | YT-2932 | 181         | YT-2988 | 182         | YT-3230 | 195; 458; 460 | YT-3286 | 177         | YT-3402  | 196         |
| YT-2686 | 92          | YT-2763 | 92          | YT-2827  | 104; 138    | YT-2933 | 181         | YT-2989 | 182         | YT-3231 | 195; 458; 460 | YT-3287 | 177         | YT-3403  | 196         |
| YT-2687 | 92          | YT-2764 | 92          | YT-2828  | 104; 138    | YT-2934 | 181         | YT-2990 | 182         | YT-3232 | 195; 458; 460 | YT-3288 | 177         | YT-3404  | 196         |
| YT-2688 | 92          | YT-2765 | 92          | YT-2830  | 148         | YT-2935 | 181         | YT-2991 | 182         | YT-3233 | 195; 458; 460 | YT-3289 | 177         | YT-3405  | 196         |
| YT-2689 | 92          | YT-2766 | 92          | YT-2840  | 93          | YT-2937 | 181         | YT-2992 | 182         | YT-3234 | 195; 458; 460 | YT-3290 | 177         | YT-3407  | 196         |
| YT-2690 | 92          | YT-2767 | 92          | YT-2842  | 93          | YT-2939 | 181         | YT-2993 | 182         | YT-3236 | 176           | YT-3291 | 177         | YT-3408  | 196         |
| YT-2691 | 92          | YT-2768 | 92          | YT-2843  | 93          | YT-2940 | 181         | YT-2994 | 182         | YT-3237 | 176           | YT-3292 | 177         | YT-3409  | 196         |
| YT-2692 | 92          | YT-2769 | 92          | YT-2844  | 93          | YT-2941 | 181         | YT-2995 | 182         | YT-3238 | 176           | YT-3293 | 177         | YT-3410  | 196         |
| YT-2693 | 92          | YT-2770 | 92          | YT-2845  | 93          | YT-2942 | 181         | YT-2996 | 182         | YT-3239 | 176           | YT-3294 | 177         | YT-3411  | 196         |
| YT-2694 | 92          | YT-2771 | 92          | YT-2846  | 93          | YT-2943 | 181         | YT-2997 | 182         | YT-3240 | 176           | YT-3295 | 177         | YT-3412  | 196         |
| YT-2699 | 93          | YT-2772 | 92          | YT-2847  | 93          | YT-2944 | 181         | YT-3001 | 273         | YT-3241 | 176           | YT-3296 | 177         | YT-3413  | 196         |
| YT-2700 | 93          | YT-2773 | 92          | YT-28480 | 330         | YT-2945 | 181         | YT-3002 | 273         | YT-3242 | 176           | YT-3297 | 177         | YT-3414  | 196         |
| YT-2701 | 93          | YT-2774 | 92          | YT-2861  | 148; 266    | YT-2946 | 181         | YT-3003 | 273         | YT-3243 | 176           | YT-3298 | 177         | YT-3415  | 196         |
| YT-2702 | 93          | YT-2775 | 92          | YT-2862  | 148; 266    | YT-2947 | 181         | YT-3004 | 273         | YT-3244 | 176           | YT-3299 | 177         | YT-3416  | 196         |
| YT-2703 | 93          | YT-2776 | 92          | YT-2863  | 148; 266    | YT-2948 | 181         | YT-3005 | 273         | YT-3245 | 176           | YT-3300 | 177         | YT-3417  | 196         |
| YT-2704 | 93          | YT-2777 | 92          | YT-28631 | 148         | YT-2949 | 181         | YT-3022 | 273         | YT-3246 | 176           | YT-3303 | 179         | YT-3421  | 196         |
| YT-2705 | 93          | YT-2778 | 92          | YT-2864  | 148         | YT-2950 | 181         | YT-3023 | 273         | YT-3247 | 176           | YT-3304 | 179         | YT-3430  | 197         |
| YT-2706 | 93          | YT-2779 | 92          | YT-2865  | 365         | YT-2951 | 181         | YT-3024 | 273         | YT-3248 | 176           | YT-3306 | 179         | YT-3431  | 197         |
| YT-2708 | 93          | YT-2780 | 106         | YT-2866  | 365         | YT-2952 | 181         | YT-3025 | 273         | YT-3249 | 176           | YT-3308 | 179         | YT-3432  | 197         |
| YT-2709 | 93          | YT-2781 | 95          | YT-28950 | 178         | YT-2953 | 181         | YT-3026 | 273         | YT-3250 | 176           | YT-3311 | 179         | YT-3433  | 197         |
| YT-2710 | 93          | YT-2782 | 94          | YT-28951 | 178         | YT-2954 | 181         | YT-3071 | 258         | YT-3251 | 176           | YT-3313 | 179         | YT-3434  | 197         |
| YT-2711 | 93          | YT-2783 | 94          | YT-28952 | 178         | YT-2955 | 181         | YT-3072 | 258         | YT-3252 | 176           | YT-3315 | 179         | YT-3435  | 197         |
| YT-2712 | 93          | YT-2784 | 94          | YT-28953 | 178         | YT-2956 | 181         | YT-3073 | 258         | YT-3253 | 176           | YT-3317 | 179         | YT-3440  | 197         |
| YT-2715 | 92          | YT-2785 | 95          | YT-28954 | 178         | YT-2957 | 181         | YT-3074 | 258         | YT-3254 | 176           | YT-3318 | 179         | YT-3441  | 197         |
| YT-2716 | 92          | YT-2786 | 95          | YT-28955 | 178         | YT-2958 | 181         | YT-3076 | 258         | YT-3255 | 176           | YT-3321 | 179         | YT-3442  | 197         |
| YT-2717 | 92          | YT-2787 | 94          | YT-28956 | 178         | YT-2959 | 181         | YT-3077 | 258         | YT-3256 | 176           | YT-3322 | 179         | YT-3443  | 197         |
| YT-2718 | 92          | YT-2788 | 94          | YT-28957 | 178         | YT-2960 | 182         | YT-3078 | 258         | YT-3257 | 176           | YT-3323 | 179         | YT-3444  | 197         |
| YT-2719 | 92          | YT-2789 | 95          | YT-28958 | 178         | YT-2961 | 182         | YT-3079 | 258         | YT-3258 | 176           | YT-3324 | 179         | YT-3445  | 197         |
| YT-2721 | 92          | YT-2790 | 96          | YT-28959 | 178         | YT-2962 | 182         | YT-3081 | 258         | YT-3259 | 176           | YT-3327 | 179         | YT-3460  | 195         |
| YT-2722 | 92          | YT-2791 | 96          | YT-28960 | 178         | YT-2963 | 182         | YT-3082 | 258         | YT-3261 | 177           | YT-3329 | 179         | YT-3461  | 195         |
| YT-2723 | 92          | YT-2795 | 96          | YT-28961 | 178         | YT-2964 | 182         | YT-3083 | 258         | YT-3262 | 177           | YT-3330 | 179         | YT-3462  | 195         |
| YT-2725 | 92          | YT-2797 | 105         | YT-28962 | 178         | YT-2965 | 182         | YT-3084 | 258         | YT-3263 | 177           | YT-3332 | 179         | YT-34680 | 198         |
| YT-2727 | 92          | YT-2798 | 105         | YT-28963 | 178         | YT-2966 | 182         | YT-3101 | 194         | YT-3264 | 177           | YT-3333 | 179         | YT-34681 | 198         |
| YT-2728 | 92          | YT-2799 | 106         | YT-28964 | 178         | YT-2967 | 182         | YT-3102 | 194         | YT-3265 | 177           | YT-3334 | 179         | YT-34682 | 198         |
| YT-2729 | 92          | YT-2800 | 107         | YT-28965 | 178         | YT-2968 | 182         | YT-3103 | 194         | YT-3266 | 177           | YT-3336 | 179         | YT-34683 | 198         |
| YT-2730 | 92          | YT-2801 | 107         | YT-28966 | 178         | YT-2969 | 182         | YT-3106 | 194         | YT-3267 | 177           | YT-3338 | 179         | YT-34684 | 199         |
| YT-2731 | 92          | YT-2802 | 107         | YT-28967 | 178         | YT-2970 | 182         | YT-3107 | 194         | YT-3268 | 177           | YT-3343 | 179         | YT-34685 | 199         |
| YT-2732 | 92          | YT-2804 | 105         | YT-2900  | 224         | YT-2971 | 182         | YT-3108 | 194         | YT-3269 | 177           | YT-3345 | 179         | YT-34686 | 199         |
| YT-2733 | 92          | YT-2806 | 107         | YT-29001 | 224         | YT-2972 | 182         | YT-3130 | 194         | YT-3270 | 177           | YT-3346 | 179         | YT-34687 | 199         |
| YT-2741 | 101         | YT-2808 | 105         | YT-2910  | 224         | YT-2973 | 182         | YT-3133 | 194         | YT-3271 | 177           | YT-3349 | 179         | YT-34688 | 200         |
| YT-2742 | 101         | YT-2810 | 108         | YT-2911  | 224         | YT-2974 | 182         | YT-3134 | 194         | YT-3272 | 177           | YT-3350 | 179         | YT-34689 | 200         |
| YT-2743 | 101         | YT-2811 | 108         | YT-2912  | 224         | YT-2975 | 181         | YT-3150 | 194         | YT-3273 | 177           | YT-3351 | 179         | YT-34690 | 200         |
| YT-2744 | 101         | YT-2812 | 108         | YT-2913  | 224         | YT-2976 | 182         | YT-3160 | 195         | YT-3274 | 177           | YT-3353 | 179         | YT-34691 | 200         |
| YT-2745 | 101         | YT-2815 | 104; 138    | YT-2914  | 224         | YT-2977 | 182         | YT-3161 | 195         | YT-3275 | 177           | YT-3370 | 179         | YT-3590  | 208         |
| YT-2746 | 101         | YT-2816 | 104; 138    | YT-2916  | 224         | YT-2978 | 181         | YT-3163 | 195         | YT-3276 | 177           | YT-3371 | 179         | YT-3591  | 208         |



| YATO     | page/strona   | YATO     | page/strona | YATO     | page/strona | YATO    | page/strona | YATO    | page/strona | YATO    | page/strona | YATO     | page/strona | YATO     | page/strona |
|----------|---------------|----------|-------------|----------|-------------|---------|-------------|---------|-------------|---------|-------------|----------|-------------|----------|-------------|
| YT-3600  | 236           | YT-3810  | 31          | YT-38781 | 43          | YT-4140 | 174         | YT-4220 | 174         | YT-4444 | 173         | YT-4570  | 157         | YT-4705  | 160         |
| YT-36011 | 236           | YT-3811  | 31          | YT-38782 | 61          | YT-4160 | 174         | YT-4221 | 174         | YT-4445 | 173         | YT-4571  | 157         | YT-4710  | 160         |
| YT-36012 | 236           | YT-3812  | 31          | YT-3879  | 64          | YT-4161 | 175         | YT-4222 | 174         | YT-4446 | 173         | YT-4573  | 157         | YT-4711  | 161         |
| YT-3609  | 236           | YT-3813  | 31          | YT-38791 | 45          | YT-4162 | 175         | YT-4223 | 174         | YT-4447 | 173         | YT-4590  | 159; 381    | YT-4712  | 161         |
| YT-36092 | 236           | YT-3814  | 31          | YT-3880  | 66          | YT-4163 | 175         | YT-4224 | 174         | YT-4448 | 173         | YT-4594  | 158         | YT-47121 | 161         |
| YT-36095 | 237           | YT-3820  | 31          | YT-38801 | 47          | YT-4164 | 175         | YT-4225 | 174         | YT-4449 | 173         | YT-4600  | 158         | YT-4713  | 162         |
| YT-3610  | 237           | YT-3821  | 31          | YT-3881  | 68          | YT-4165 | 175         | YT-4226 | 174         | YT-4450 | 173         | YT-4601  | 158         | YT-4714  | 162         |
| YT-36119 | 238           | YT-3822  | 31          | YT-38811 | 48          | YT-4166 | 175         | YT-4227 | 174         | YT-4451 | 173         | YT-4602  | 158         | YT-47141 | 161         |
| YT-3612  | 237           | YT-3823  | 31          | YT-3882  | 57          | YT-4167 | 175         | YT-4228 | 174         | YT-4452 | 173         | YT-4603  | 158         | YT-47142 | 161         |
| YT-36129 | 238           | YT-3824  | 31          | YT-38821 | 42          | YT-4168 | 175         | YT-4229 | 174         | YT-4453 | 173         | YT-4604  | 158         | YT-47143 | 161         |
| YT-3613  | 237           | YT-3825  | 31          | YT-3883  | 66          | YT-4169 | 175         | YT-4230 | 174         | YT-4454 | 173         | YT-4605  | 158         | YT-47144 | 161         |
| YT-3617  | 238; 286      | YT-3826  | 31          | YT-38831 | 46          | YT-4170 | 175         | YT-4350 | 177         | YT-4455 | 173         | YT-4620  | 158; 382    | YT-47145 | 161         |
| YT-3618  | 238; 286      | YT-3827  | 31          | YT-3884  | 69          | YT-4171 | 175         | YT-4351 | 177         | YT-4456 | 173         | YT-4622  | 158; 382    | YT-47146 | 161         |
| YT-3635  | 238           | YT-3828  | 31          | YT-38841 | 49          | YT-4172 | 175         | YT-4352 | 177         | YT-4457 | 173         | YT-4623  | 158; 382    | YT-47147 | 161         |
| YT-3636  | 238           | YT-3829  | 31          | YT-3886  | 57          | YT-4173 | 175         | YT-4353 | 177         | YT-4458 | 173         | YT-4624  | 158; 382    | YT-47148 | 161         |
| YT-36700 | 230; 244; 406 | YT-3830  | 31          | YT-38861 | 42          | YT-4174 | 175         | YT-4354 | 177         | YT-4460 | 173         | YT-4625  | 158; 382    | YT-47149 | 161         |
| YT-36704 | 231; 245; 407 | YT-3831  | 31          | YT-3887  | 67          | YT-4175 | 175         | YT-4355 | 177         | YT-4461 | 173         | YT-4626  | 158; 382    | YT-47150 | 161         |
| YT-36706 | 230; 244; 406 | YT-3832  | 31          | YT-38872 | 47          | YT-4176 | 175         | YT-4356 | 177         | YT-4462 | 173         | YT-4630  | 158; 382    | YT-47151 | 161         |
| YT-36709 | 231; 245; 407 | YT-3833  | 31          | YT-3888  | 67          | YT-4177 | 175         | YT-4357 | 177         | YT-4491 | 156         | YT-4631  | 158; 382    | YT-47152 | 161         |
| YT-3701  | 250           | YT-3839  | 32          | YT-38881 | 48          | YT-4178 | 175         | YT-4358 | 177         | YT-4492 | 156         | YT-4632  | 158; 382    | YT-4720  | 178         |
| YT-3702  | 250           | YT-3840  | 32          | YT-3889  | 65          | YT-4179 | 175         | YT-4359 | 177         | YT-4493 | 156         | YT-4633  | 158; 382    | YT-4721  | 178         |
| YT-3703  | 251           | YT-3841  | 32          | YT-38891 | 45          | YT-4180 | 175         | YT-4361 | 175         | YT-4494 | 156         | YT-4634  | 158; 382    | YT-4722  | 178         |
| YT-3704  | 251           | YT-3842  | 31          | YT-3890  | 65          | YT-4181 | 175         | YT-4362 | 175         | YT-4495 | 156         | YT-4635  | 158; 382    | YT-4723  | 178         |
| YT-3705  | 251           | YT-3843  | 31          | YT-38901 | 46          | YT-4182 | 175         | YT-4363 | 175         | YT-4496 | 156         | YT-4636  | 158; 382    | YT-4730  | 163         |
| YT-3706  | 251           | YT-3844  | 31          | YT-3891  | 62          | YT-4183 | 175         | YT-4364 | 175         | YT-4497 | 156         | YT-4637  | 158; 382    | YT-4750  | 203         |
| YT-3707  | 251           | YT-3845  | 31          | YT-3893  | 68          | YT-4184 | 175         | YT-4367 | 175         | YT-4498 | 156         | YT-4638  | 158; 382    | YT-4751  | 203         |
| YT-3708  | 251           | YT-3847  | 31          | YT-38931 | 49          | YT-4185 | 175         | YT-4369 | 175         | YT-4499 | 156         | YT-4639  | 158; 382    | YT-4752  | 203         |
| YT-3712  | 251           | YT-3848  | 31          | YT-3894  | 69          | YT-4186 | 175         | YT-4370 | 175         | YT-4500 | 156         | YT-4640  | 158; 382    | YT-4755  | 203         |
| YT-3713  | 251           | YT-3849  | 31          | YT-38941 | 50          | YT-4187 | 175         | YT-4373 | 175         | YT-4501 | 156         | YT-4641  | 158; 382    | YT-4757  | 203         |
| YT-3714  | 251           | YT-3850  | 32          | YT-3895  | 309         | YT-4188 | 175         | YT-4375 | 175         | YT-4502 | 156         | YT-4642  | 158; 382    | YT-4758  | 203         |
| YT-37160 | 252           | YT-3851  | 32; 349     | YT-38950 | 310         | YT-4189 | 175         | YT-4376 | 175         | YT-4503 | 156         | YT-4643  | 158; 382    | YT-4759  | 203         |
| YT-37161 | 252           | YT-3853  | 32          | YT-38951 | 310         | YT-4190 | 175         | YT-4379 | 175         | YT-4504 | 156         | YT-4644  | 158; 382    | YT-4761  | 203         |
| YT-37162 | 252           | YT-3854  | 32          | YT-4020  | 174         | YT-4191 | 175         | YT-4380 | 175         | YT-4505 | 156         | YT-46800 | 163         | YT-4763  | 203         |
| YT-37163 | 252           | YT-3855  | 55          | YT-4025  | 174         | YT-4192 | 175         | YT-4383 | 175         | YT-4506 | 156         | YT-46801 | 163         | YT-4764  | 203         |
| YT-37164 | 252           | YT-3856  | 55          | YT-4030  | 174         | YT-4200 | 174         | YT-4385 | 175         | YT-4507 | 156         | YT-46802 | 163         | YT-4766  | 203         |
| YT-37170 | 252           | YT-38561 | 41          | YT-4032  | 174         | YT-4201 | 174         | YT-4390 | 175         | YT-4508 | 156         | YT-46803 | 163         | YT-4767  | 203         |
| YT-3725  | 178           | YT-3857  | 56          | YT-4035  | 174         | YT-4202 | 174         | YT-4400 | 179         | YT-4509 | 156         | YT-46804 | 163         | YT-4768  | 203         |
| YT-3726  | 178           | YT-38631 | 55          | YT-4040  | 174         | YT-4203 | 174         | YT-4401 | 179         | YT-4510 | 156         | YT-46810 | 163         | YT-4769  | 203         |
| YT-3727  | 178           | YT-38641 | 55          | YT-4042  | 174         | YT-4204 | 174         | YT-4402 | 179         | YT-4515 | 159; 381    | YT-46811 | 163         | YT-4830  | 13          |
| YT-3728  | 178           | YT-3865  | 70          | YT-4045  | 174         | YT-4205 | 174         | YT-4403 | 179         | YT-4516 | 159; 381    | YT-46812 | 163         | YT-4831  | 13          |
| YT-3730  | 250           | YT-3867  | 58          | YT-4048  | 174         | YT-4206 | 174         | YT-4430 | 173         | YT-4518 | 159; 381    | YT-46813 | 163         | YT-4832  | 13          |
| YT-3735  | 208; 253      | YT-38671 | 43          | YT-4050  | 174         | YT-4207 | 174         | YT-4431 | 173         | YT-4519 | 159; 381    | YT-46814 | 163         | YT-4833  | 13          |
| YT-3736  | 208; 253      | YT-3868  | 57          | YT-4052  | 174         | YT-4208 | 174         | YT-4432 | 173         | YT-4520 | 159; 381    | YT-46820 | 163         | YT-4834  | 13          |
| YT-3740  | 208           | YT-38681 | 42          | YT-4055  | 174         | YT-4209 | 174         | YT-4433 | 173         | YT-4521 | 159; 381    | YT-46821 | 163         | YT-4835  | 13          |
| YT-37690 | 78            | YT-38682 | 57          | YT-4060  | 174         | YT-4210 | 174         | YT-4434 | 173         | YT-4522 | 159; 381    | YT-46822 | 163         | YT-4836  | 13          |
| YT-3801  | 31            | YT-3869  | 59          | YT-4065  | 174         | YT-4211 | 174         | YT-4435 | 173         | YT-4550 | 156         | YT-46823 | 163         | YT-4837  | 13          |
| YT-3802  | 31            | YT-3870  | 59          | YT-4070  | 174         | YT-4212 | 174         | YT-4436 | 173         | YT-4551 | 156         | YT-4690  | 162         | YT-4860  | 16          |
| YT-3803  | 31            | YT-3871  | 60          | YT-4075  | 174         | YT-4213 | 174         | YT-4437 | 173         | YT-4552 | 156         | YT-4691  | 162         | YT-4861  | 16          |
| YT-3804  | 31            | YT-3872  | 59          | YT-4080  | 174         | YT-4214 | 174         | YT-4438 | 173         | YT-4553 | 156         | YT-4692  | 162         | YT-4862  | 16          |
| YT-3805  | 31            | YT-3873  | 59          | YT-4085  | 174         | YT-4215 | 174         | YT-4439 | 173         | YT-4560 | 157         | YT-4693  | 162         | YT-4863  | 16          |
| YT-3806  | 31            | YT-3874  | 60          | YT-4090  | 174         | YT-4216 | 174         | YT-4440 | 173         | YT-4561 | 157         | YT-4694  | 162         | YT-4864  | 16          |
| YT-3807  | 31            | YT-3876  | 60          | YT-4100  | 174         | YT-4217 | 174         | YT-4441 | 173         | YT-4562 | 157         | YT-4695  | 162         | YT-4865  | 16          |
| YT-3808  | 31            | YT-3877  | 61          | YT-4110  | 174         | YT-4218 | 174         | YT-4442 | 173         | YT-4563 | 157         | YT-4700  | 160         | YT-4870  | 8           |
| YT-3809  | 31            | YT-3878  | 62          | YT-4120  | 174         | YT-4219 | 174         | YT-4443 | 173         | YT-4564 | 157         | YT-4701  | 160         | YT-4871  | 8           |

| YATO    | page/strona | YATO    | page/strona | YATO     | page/strona | YATO     | page/strona | YATO    | page/strona   | YATO    | page/strona | YATO    | page/strona | YATO    | page/strona |
|---------|-------------|---------|-------------|----------|-------------|----------|-------------|---------|---------------|---------|-------------|---------|-------------|---------|-------------|
| YT-4872 | 8           | YT-4964 | 20          | YT-5247  | 255         | YT-55361 | 306         | YT-5774 | 114           | YT-5927 | 187         | YT-6063 | 187         | YT-6135 | 188         |
| YT-4873 | 8           | YT-4965 | 20          | YT-5250  | 253         | YT-5537  | 303         | YT-5775 | 114           | YT-5930 | 188         | YT-6065 | 187         | YT-6136 | 187         |
| YT-4874 | 8           | YT-4966 | 20          | YT-5251  | 253         | YT-55371 | 306         | YT-5777 | 114           | YT-5932 | 188         | YT-6066 | 187         | YT-6137 | 187         |
| YT-4875 | 8           | YT-5000 | 8           | YT-5252  | 253         | YT-5538  | 303         | YT-5778 | 114           | YT-5933 | 188         | YT-6067 | 187         | YT-6138 | 188         |
| YT-4876 | 8           | YT-5001 | 8           | YT-5253  | 253         | YT-55381 | 306         | YT-5779 | 114           | YT-5934 | 188         | YT-6068 | 187         | YT-6140 | 213         |
| YT-4877 | 8           | YT-5002 | 8           | YT-5254  | 253         | YT-5539  | 304         | YT-5780 | 114           | YT-5935 | 188         | YT-6070 | 187         | YT-6141 | 213         |
| YT-4878 | 8           | YT-5003 | 8           | YT-5255  | 253         | YT-55391 | 306         | YT-5781 | 114           | YT-5940 | 187         | YT-6071 | 187         | YT-6142 | 213         |
| YT-4879 | 8           | YT-5005 | 8           | YT-5260  | 253         | YT-5540  | 304         | YT-5785 | 114           | YT-5942 | 187         | YT-6072 | 187         | YT-6143 | 213         |
| YT-4880 | 8           | YT-5006 | 8           | YT-5261  | 253         | YT-55401 | 306         | YT-5786 | 114           | YT-5944 | 187         | YT-6075 | 187         | YT-6144 | 214         |
| YT-4881 | 8           | YT-5008 | 8           | YT-5262  | 253         | YT-5541  | 303         | YT-5791 | 114           | YT-5945 | 187         | YT-6076 | 187         | YT-6145 | 214         |
| YT-4882 | 8           | YT-5009 | 8           | YT-5302  | 255         | YT-55411 | 306         | YT-5792 | 114           | YT-5946 | 188         | YT-6077 | 187         | YT-6146 | 214         |
| YT-4883 | 8           | YT-5010 | 8           | YT-5304  | 255         | YT-5542  | 303         | YT-5793 | 114           | YT-5947 | 188         | YT-6078 | 187         | YT-6147 | 213         |
| YT-4884 | 8           | YT-5012 | 8           | YT-5400  | 257         | YT-55421 | 306         | YT-5794 | 114           | YT-5948 | 188         | YT-6080 | 187         | YT-6148 | 213         |
| YT-4885 | 8           | YT-5014 | 8           | YT-5402  | 257         | YT-5543  | 300         | YT-5795 | 114           | YT-5949 | 188         | YT-6081 | 187         | YT-6149 | 213         |
| YT-4901 | 9           | YT-5015 | 8           | YT-5404  | 257         | YT-55443 | 301         | YT-5796 | 114           | YT-5953 | 185         | YT-6082 | 187         | YT-6150 | 213         |
| YT-4902 | 9           | YT-5016 | 8           | YT-5405  | 257         | YT-55444 | 302         | YT-5797 | 114           | YT-5954 | 185         | YT-6083 | 187         | YT-6151 | 214         |
| YT-4903 | 9           | YT-5017 | 8           | YT-5410  | 257         | YT-55451 | 304         | YT-5798 | 114           | YT-5955 | 185         | YT-6085 | 187         | YT-6152 | 213         |
| YT-4904 | 9           | YT-5018 | 8           | YT-5415  | 257; 389    | YT-55453 | 304         | YT-5802 | 114           | YT-5956 | 185         | YT-6086 | 187         | YT-6153 | 213         |
| YT-4905 | 9           | YT-5019 | 8           | YT-5416  | 257; 389    | YT-55455 | 302         | YT-5803 | 114           | YT-5965 | 185         | YT-6091 | 187         | YT-6154 | 213         |
| YT-4906 | 9           | YT-5020 | 8           | YT-5417  | 257; 389    | YT-55456 | 301         | YT-5804 | 114           | YT-5966 | 185         | YT-6093 | 187         | YT-6155 | 213         |
| YT-4907 | 9           | YT-5021 | 8           | YT-5483  | 262         | YT-55457 | 304         | YT-5805 | 114           | YT-5973 | 186         | YT-6095 | 187         | YT-6156 | 213         |
| YT-4908 | 9           | YT-5022 | 8           | YT-5490  | 262         | YT-55458 | 303         | YT-5806 | 114           | YT-5974 | 186         | YT-6097 | 187         | YT-6160 | 213         |
| YT-4909 | 9           | YT-5023 | 8           | YT-5491  | 262         | YT-55462 | 303         | YT-5807 | 114           | YT-5975 | 186         | YT-6099 | 187         | YT-6161 | 213         |
| YT-4910 | 9           | YT-5024 | 8           | YT-5492  | 262         | YT-55463 | 301         | YT-5808 | 114           | YT-5991 | 186         | YT-6101 | 187         | YT-6162 | 213         |
| YT-4911 | 9           | YT-5025 | 8           | YT-5493  | 262         | YT-55464 | 302         | YT-5812 | 114           | YT-5992 | 186         | YT-6102 | 187         | YT-6163 | 213         |
| YT-4912 | 9           | YT-5030 | 14          | YT-5494  | 262         | YT-55465 | 305         | YT-5813 | 114           | YT-5994 | 186         | YT-6103 | 187         | YT-6164 | 213         |
| YT-4915 | 21          | YT-5031 | 14          | YT-5496  | 262         | YT-55466 | 305         | YT-5814 | 114           | YT-6002 | 185         | YT-6104 | 187         | YT-6165 | 213         |
| YT-4916 | 21          | YT-5033 | 14          | YT-5497  | 262         | YT-55469 | 302         | YT-5820 | 115           | YT-6003 | 185         | YT-6105 | 187         | YT-6180 | 212         |
| YT-4917 | 21          | YT-5038 | 14          | YT-5499  | 262         | YT-55471 | 305         | YT-5821 | 115           | YT-6004 | 185         | YT-6106 | 187         | YT-6181 | 212         |
| YT-4918 | 21          | YT-5130 | 133; 384    | YT-5500  | 262         | YT-55472 | 301         | YT-5822 | 115           | YT-6005 | 185         | YT-6107 | 187         | YT-6182 | 212         |
| YT-4919 | 21          | YT-5131 | 133; 384    | YT-5501  | 262         | YT-55473 | 301         | YT-5823 | 115           | YT-6012 | 185         | YT-6108 | 187         | YT-6183 | 212         |
| YT-4920 | 21          | YT-5140 | 133; 384    | YT-5502  | 262         | YT-55474 | 304         | YT-5832 | 115           | YT-6013 | 185         | YT-6110 | 187         | YT-6184 | 212         |
| YT-4921 | 21          | YT-5141 | 133; 384    | YT-5503  | 262         | YT-55476 | 305         | YT-5833 | 115           | YT-6014 | 185         | YT-6111 | 187         | YT-6185 | 212         |
| YT-4922 | 21          | YT-5142 | 133; 384    | YT-5504  | 262         | YT-55477 | 305         | YT-5835 | 115           | YT-6015 | 185         | YT-6112 | 187         | YT-6186 | 212         |
| YT-4923 | 21          | YT-5200 | 254         | YT-5505  | 262         | YT-55478 | 305         | YT-5837 | 115           | YT-6016 | 185         | YT-6113 | 187         | YT-6187 | 212         |
| YT-4924 | 21          | YT-5202 | 254         | YT-5506  | 262         | YT-55479 | 306         | YT-5838 | 115           | YT-6017 | 185         | YT-6114 | 188         | YT-6188 | 212         |
| YT-4925 | 21          | YT-5203 | 254         | YT-5507  | 262         | YT-5555  | 369         | YT-5890 | 373           | YT-6022 | 185         | YT-6115 | 188         | YT-6189 | 212         |
| YT-4926 | 21          | YT-5204 | 254         | YT-5508  | 262         | YT-55560 | 374         | YT-5892 | 373           | YT-6023 | 185         | YT-6116 | 188         | YT-6190 | 212         |
| YT-4927 | 21          | YT-5207 | 254         | YT-55290 | 295         | YT-55561 | 374         | YT-5893 | 373           | YT-6024 | 185         | YT-6117 | 188         | YT-6191 | 212         |
| YT-4928 | 21          | YT-5209 | 254         | YT-55291 | 291         | YT-55562 | 374         | YT-5894 | 373           | YT-6025 | 185         | YT-6119 | 188         | YT-6192 | 212         |
| YT-4937 | 21          | YT-5210 | 254         | YT-55292 | 294         | YT-55565 | 375         | YT-5901 | 259; 373; 405 | YT-6030 | 186         | YT-6120 | 188         | YT-6193 | 212         |
| YT-4945 | 21          | YT-5212 | 254         | YT-55293 | 292         | YT-55568 | 375         | YT-5902 | 259; 373; 405 | YT-6032 | 186         | YT-6121 | 188         | YT-6194 | 212         |
| YT-4950 | 20          | YT-5214 | 254         | YT-5530  | 293         | YT-55580 | 375         | YT-5904 | 259; 373; 405 | YT-6045 | 186         | YT-6122 | 187         | YT-6219 | 215         |
| YT-4951 | 20          | YT-5216 | 254         | YT-5531  | 300         | YT-55581 | 375         | YT-5905 | 259; 373; 405 | YT-6046 | 186         | YT-6123 | 188         | YT-6220 | 215         |
| YT-4952 | 20          | YT-5218 | 254         | YT-55311 | 306         | YT-55582 | 375         | YT-5911 | 373           | YT-6050 | 187         | YT-6124 | 188         | YT-6221 | 215         |
| YT-4953 | 20          | YT-5226 | 254         | YT-5532  | 300         | YT-5702  | 211         | YT-5913 | 373           | YT-6052 | 187         | YT-6125 | 188         | YT-6222 | 215         |
| YT-4954 | 20          | YT-5228 | 254         | YT-55321 | 306         | YT-5703  | 211         | YT-5914 | 373           | YT-6053 | 187         | YT-6126 | 188         | YT-6223 | 212         |
| YT-4955 | 20          | YT-5230 | 254         | YT-5533  | 300         | YT-5704  | 211         | YT-5920 | 187           | YT-6055 | 187         | YT-6128 | 188         | YT-6224 | 212         |
| YT-4956 | 20          | YT-5234 | 255         | YT-55331 | 306         | YT-5710  | 208         | YT-5921 | 187           | YT-6056 | 187         | YT-6129 | 188         | YT-6225 | 212         |
| YT-4957 | 20          | YT-5237 | 255         | YT-5534  | 301         | YT-5761  | 114         | YT-5922 | 187           | YT-6057 | 187         | YT-6130 | 188         | YT-6226 | 212         |
| YT-4960 | 20          | YT-5240 | 255         | YT-55341 | 306         | YT-5770  | 114         | YT-5923 | 187           | YT-6058 | 187         | YT-6131 | 188         | YT-6227 | 212         |
| YT-4961 | 20          | YT-5242 | 255         | YT-5535  | 302         | YT-5771  | 114         | YT-5924 | 187           | YT-6060 | 187         | YT-6132 | 188         | YT-6228 | 212         |
| YT-4962 | 20          | YT-5243 | 255         | YT-55351 | 306         | YT-5772  | 114         | YT-5925 | 187           | YT-6061 | 187         | YT-6133 | 188         | YT-6229 | 212         |
| YT-4963 | 20          | YT-5245 | 255         | YT-5536  | 302         | YT-5773  | 114         | YT-5926 | 187           | YT-6062 | 187         | YT-6134 | 188         | YT-6230 | 212         |



| YATO    | page/strona | YATO     | page/strona | YATO     | page/strona   | YATO     | page/strona | YATO     | page/strona | YATO     | page/strona | YATO     | page/strona | YATO     | page/strona |
|---------|-------------|----------|-------------|----------|---------------|----------|-------------|----------|-------------|----------|-------------|----------|-------------|----------|-------------|
| YT-6231 | 212         | YT-63701 | 202; 232    | YT-6454  | 166           | YT-6925  | 262         | YT-7054  | 239         | YT-7201  | 270         | YT-73761 | 420         | YT-74954 | 424         |
| YT-6232 | 212         | YT-63702 | 202; 232    | YT-6501  | 167           | YT-6926  | 262         | YT-7055  | 239         | YT-7220  | 273         | YT-7377  | 421         | YT-74956 | 424         |
| YT-6233 | 212         | YT-63703 | 202; 232    | YT-6502  | 167           | YT-6927  | 262         | YT-7070  | 270         | YT-7221  | 273         | YT-7380  | 421         | YT-74959 | 424         |
| YT-6234 | 212         | YT-63704 | 202; 232    | YT-6503  | 167           | YT-69280 | 263         | YT-7071  | 270         | YT-7222  | 273         | YT-73801 | 421         | YT-7500  | 206         |
| YT-6235 | 212         | YT-63705 | 202; 232    | YT-6504  | 167           | YT-69281 | 263         | YT-7080  | 270         | YT-7223  | 273         | YT-7381  | 421         | YT-7501  | 206         |
| YT-6236 | 212         | YT-6401  | 166         | YT-65048 | 167           | YT-69285 | 263         | YT-7081  | 270         | YT-72300 | 271         | YT-7382  | 421         | YT-7503  | 207         |
| YT-6237 | 212         | YT-6402  | 166         | YT-65049 | 167           | YT-69286 | 263         | YT-7082  | 270         | YT-72301 | 271         | YT-7383  | 421         | YT-7504  | 207         |
| YT-6238 | 212         | YT-6403  | 166         | YT-6505  | 167           | YT-69287 | 263         | YT-7083  | 270         | YT-72302 | 271         | YT-73830 | 421         | YT-7505  | 207         |
| YT-6239 | 212         | YT-6404  | 166         | YT-6506  | 167           | YT-6966  | 412         | YT-7084  | 270         | YT-72303 | 271         | YT-73921 | 380         | YT-7506  | 207         |
| YT-6241 | 160         | YT-6405  | 166         | YT-6510  | 167; 232      | YT-6980  | 412         | YT-7103  | 268         | YT-72305 | 271         | YT-7400  | 416         | YT-7507  | 207         |
| YT-6242 | 160         | YT-6406  | 166         | YT-6511  | 167; 232      | YT-6981  | 412         | YT-7105  | 268         | YT-7290  | 359         | YT-7409  | 416         | YT-7510  | 206         |
| YT-6243 | 160         | YT-6407  | 166         | YT-6512  | 167; 232      | YT-6982  | 412         | YT-7110  | 268         | YT-7291  | 359         | YT-7410  | 416         | YT-7511  | 207         |
| YT-6244 | 160         | YT-6408  | 166         | YT-6513  | 167; 232      | YT-6983  | 412         | YT-7111  | 268         | YT-7292  | 359         | YT-7413  | 416         | YT-7512  | 207         |
| YT-6245 | 160         | YT-6409  | 166         | YT-6581  | 123           | YT-6984  | 412         | YT-7112  | 268         | YT-7300  | 345         | YT-7414  | 416         | YT-7520  | 206         |
| YT-6246 | 160         | YT-6410  | 166         | YT-6582  | 123           | YT-6985  | 412         | YT-71130 | 268         | YT-7301  | 345         | YT-7416  | 416         | YT-7523  | 206         |
| YT-6247 | 160         | YT-6412  | 166         | YT-6583  | 123           | YT-6986  | 412         | YT-71131 | 268         | YT-7302  | 345         | YT-7417  | 416         | YT-7524  | 207         |
| YT-6248 | 160         | YT-6413  | 166         | YT-6586  | 123           | YT-6987  | 412         | YT-71133 | 268         | YT-73030 | 344         | YT-7419  | 417         | YT-7525  | 207         |
| YT-6249 | 160         | YT-6414  | 166         | YT-6587  | 123           | YT-6989  | 412         | YT-71135 | 268         | YT-7306  | 345         | YT-7420  | 417         | YT-7527  | 207         |
| YT-6251 | 160         | YT-6415  | 166         | YT-6600  | 122           | YT-69900 | 413         | YT-71136 | 268         | YT-7307  | 344         | YT-7430  | 417         | YT-7528  | 207         |
| YT-6253 | 160         | YT-6416  | 166         | YT-6601  | 122           | YT-69901 | 413         | YT-71138 | 268         | YT-73080 | 149; 267    | YT-7433  | 417         | YT-7529  | 207         |
| YT-6256 | 160         | YT-6417  | 166         | YT-6602  | 122           | YT-69902 | 413         | YT-71141 | 268         | YT-73082 | 149; 267    | YT-7435  | 417         | YT-7530  | 207         |
| YT-6258 | 160         | YT-6420  | 166         | YT-6610  | 122           | YT-69903 | 413         | YT-71143 | 268         | YT-73084 | 149; 267    | YT-7446  | 417         | YT-7531  | 207         |
| YT-6260 | 160         | YT-6421  | 166         | YT-6611  | 122           | YT-69905 | 413         | YT-71145 | 268         | YT-73086 | 149; 267    | YT-7450  | 424         | YT-7532  | 206         |
| YT-6280 | 160         | YT-6422  | 166         | YT-6612  | 122           | YT-69906 | 413         | YT-71146 | 268         | YT-73087 | 149; 267    | YT-7451  | 424         | YT-7534  | 206         |
| YT-6281 | 160         | YT-6423  | 166         | YT-6620  | 125           | YT-69907 | 413         | YT-7116  | 268         | YT-73088 | 149; 267    | YT-74510 | 424         | YT-7550  | 211         |
| YT-6330 | 201         | YT-6424  | 166         | YT-6622  | 125           | YT-69908 | 413         | YT-7117  | 268         | YT-73091 | 149; 267    | YT-7452  | 424         | YT-7551  | 211         |
| YT-6331 | 201         | YT-64270 | 166         | YT-6624  | 125           | YT-69910 | 413         | YT-7118  | 268         | YT-7310  | 347         | YT-7453  | 424         | YT-7560  | 208         |
| YT-6332 | 201         | YT-64271 | 166         | YT-6625  | 125           | YT-69911 | 413         | YT-71181 | 269         | YT-7311  | 347         | YT-7454  | 424         | YT-7561  | 208         |
| YT-6333 | 201         | YT-64272 | 166         | YT-6626  | 125           | YT-69912 | 413         | YT-71182 | 269         | YT-7312  | 347         | YT-7455  | 424         | YT-7571  | 206         |
| YT-6334 | 201         | YT-64280 | 166         | YT-6700  | 230; 244; 406 | YT-69913 | 413         | YT-71184 | 269         | YT-73124 | 272         | YT-7456  | 424         | YT-7581  | 206         |
| YT-6335 | 201         | YT-64281 | 166         | YT-6705  | 230; 244; 406 | YT-69914 | 413         | YT-71185 | 269         | YT-73125 | 272         | YT-7458  | 425         | YT-7600  | 146; 204    |
| YT-6336 | 201         | YT-64282 | 166         | YT-6706  | 231; 245; 407 | YT-69920 | 413         | YT-71186 | 269         | YT-73130 | 272         | YT-7459  | 425         | YT-7601  | 146; 204    |
| YT-6337 | 201         | YT-64283 | 166         | YT-6740  | 242           | YT-69921 | 413         | YT-71187 | 269         | YT-7320  | 334         | YT-7460  | 422         | YT-76030 | 205         |
| YT-6338 | 201         | YT-64284 | 166         | YT-6741  | 242           | YT-69922 | 413         | YT-71188 | 269         | YT-73310 | 364; 422    | YT-7461  | 422         | YT-76031 | 204         |
| YT-6339 | 201         | YT-64290 | 166         | YT-6742  | 242           | YT-69923 | 413         | YT-71189 | 269         | YT-7349  | 366         | YT-7462  | 425         | YT-76040 | 205         |
| YT-6340 | 201         | YT-64291 | 166         | YT-6743  | 242           | YT-69924 | 413         | YT-7126  | 268         | YT-7350  | 366         | YT-74621 | 425         | YT-76041 | 205         |
| YT-6341 | 201         | YT-64292 | 166         | YT-6745  | 242           | YT-7000  | 239         | YT-7127  | 268         | YT-7352  | 366         | YT-7463  | 425         | YT-76042 | 205         |
| YT-6342 | 202         | YT-64293 | 166         | YT-6750  | 243           | YT-7001  | 239         | YT-7128  | 268         | YT-7360  | 420         | YT-7464  | 422         | YT-76043 | 205         |
| YT-6343 | 202         | YT-64294 | 166         | YT-6751  | 243           | YT-7003  | 239         | YT-7129  | 268         | YT-7361  | 420         | YT-7465  | 422         | YT-76050 | 204         |
| YT-6344 | 202         | YT-64295 | 166         | YT-6752  | 243           | YT-7004  | 239         | YT-7130  | 268         | YT-7362  | 420         | YT-7467  | 422         | YT-76051 | 204         |
| YT-6345 | 202         | YT-6440  | 166         | YT-6753  | 243           | YT-7005  | 239         | YT-7131  | 268         | YT-7363  | 420         | YT-7469  | 422         | YT-76052 | 204         |
| YT-6346 | 202         | YT-6441  | 166         | YT-6754  | 243           | YT-7007  | 239         | YT-71551 | 269         | YT-73631 | 420         | YT-7470  | 421         | YT-7620  | 258         |
| YT-6347 | 202         | YT-6442  | 166         | YT-6755  | 243           | YT-7011  | 239         | YT-71552 | 269         | YT-7364  | 420         | YT-7471  | 422         | YT-7623  | 258         |
| YT-6348 | 202         | YT-6443  | 166         | YT-6756  | 243           | YT-7022  | 239         | YT-71555 | 269         | YT-73641 | 420         | YT-7472  | 421         | YT-7624  | 258         |
| YT-6349 | 202         | YT-6444  | 166         | YT-6757  | 243           | YT-7023  | 239         | YT-71556 | 269         | YT-7365  | 420         | YT-7473  | 421         | YT-7660  | 73          |
| YT-6350 | 202         | YT-6445  | 166         | YT-6801  | 184           | YT-7024  | 239         | YT-71560 | 269         | YT-7366  | 420         | YT-7474  | 421         | YT-7661  | 73          |
| YT-6351 | 202         | YT-6446  | 166         | YT-6803  | 184           | YT-7025  | 239         | YT-71561 | 269         | YT-7367  | 420         | YT-7480  | 422         | YT-7662  | 73          |
| YT-6353 | 201         | YT-6447  | 166         | YT-6854  | 365           | YT-7026  | 239         | YT-71562 | 269         | YT-7368  | 420         | YT-7481  | 422         | YT-7663  | 73          |
| YT-6354 | 201         | YT-6448  | 166         | YT-6855  | 365           | YT-7032  | 239         | YT-71565 | 269         | YT-7369  | 420         | YT-7485  | 423         | YT-7664  | 73          |
| YT-6355 | 201         | YT-6449  | 166         | YT-6862  | 365           | YT-7033  | 239         | YT-71566 | 269         | YT-7371  | 420         | YT-7486  | 423         | YT-7665  | 73          |
| YT-6356 | 201         | YT-6450  | 166         | YT-6863  | 365           | YT-7034  | 239         | YT-71567 | 269         | YT-7374  | 420         | YT-7488  | 423         | YT-7666  | 73          |
| YT-6358 | 201         | YT-6451  | 166         | YT-6903  | 135; 151; 361 | YT-7051  | 239         | YT-7200  | 270         | YT-73744 | 420         | YT-7492  | 423         | YT-7667  | 73          |
| YT-6359 | 201         | YT-6452  | 166         | YT-6907  | 135; 151; 361 | YT-7052  | 239         | YT-72003 | 270         | YT-7376  | 420         | YT-7497  | 423         | YT-7668  | 73          |
| YT-6360 | 201         | YT-6453  | 166         | YT-6916  | 135; 151; 361 | YT-7053  | 239         | YT-72004 | 270         | YT-73760 | 420         | YT-74951 | 423         | YT-7669  | 73          |

| YATO    | page/strona | YATO     | page/strona | YATO     | page/strona | YATO     | page/strona | YATO     | page/strona | YATO     | page/strona | YATO     | page/strona | YATO     | page/strona |
|---------|-------------|----------|-------------|----------|-------------|----------|-------------|----------|-------------|----------|-------------|----------|-------------|----------|-------------|
| YT-7670 | 73          | YT-7805  | 110         | YT-7849  | 110         | YT-80356 | 428         | YT-80572 | 426         | YT-80841 | 427         | YT-81777 | 152         | YT-8272  | 151; 246;   |
| YT-7671 | 73          | YT-7806  | 110         | YT-7851  | 110         | YT-80357 | 428         | YT-80573 | 426         | YT-80842 | 427         | YT-81790 | 434         | YT-8273  | 151; 246;   |
| YT-7672 | 73          | YT-7807  | 110         | YT-7852  | 110         | YT-80358 | 428         | YT-80574 | 426         | YT-80843 | 427         | YT-81791 | 434         | YT-8274  | 151; 246    |
| YT-7673 | 73          | YT-7808  | 110         | YT-7870  | 110         | YT-80359 | 428         | YT-80575 | 426         | YT-80844 | 427         | YT-81792 | 434         | YT-82743 | 151; 246    |
| YT-7674 | 73          | YT-7809  | 110         | YT-7880  | 110         | YT-80360 | 428         | YT-80576 | 426         | YT-80845 | 427         | YT-81793 | 434         | YT-82744 | 151; 246    |
| YT-7675 | 73          | YT-7810  | 110         | YT-7881  | 110         | YT-80361 | 428         | YT-80577 | 426         | YT-80846 | 427         | YT-81794 | 434         | YT-8300  | 370         |
| YT-7676 | 73          | YT-7811  | 110         | YT-7882  | 110         | YT-80362 | 428         | YT-80578 | 426         | YT-80847 | 427         | YT-81795 | 434         | YT-8301  | 370         |
| YT-7677 | 73          | YT-7812  | 110         | YT-7883  | 110         | YT-80363 | 428         | YT-80579 | 426         | YT-80848 | 427         | YT-81800 | 433         | YT-83016 | 370         |
| YT-7678 | 73          | YT-7813  | 110         | YT-7884  | 110         | YT-80364 | 428         | YT-80580 | 426         | YT-80849 | 427         | YT-81801 | 433         | YT-8302  | 370         |
| YT-7686 | 73          | YT-78130 | 109         | YT-7886  | 110         | YT-80365 | 428         | YT-80583 | 426         | YT-80852 | 427         | YT-81802 | 433         | YT-8303  | 370         |
| YT-7713 | 73          | YT-78131 | 109         | YT-7887  | 110         | YT-80366 | 428         | YT-80584 | 426         | YT-80853 | 427         | YT-81803 | 433         | YT-8304  | 371         |
| YT-7714 | 73          | YT-78132 | 109         | YT-7890  | 110         | YT-80367 | 428         | YT-80585 | 426         | YT-80854 | 427         | YT-81804 | 433         | YT-8305  | 371         |
| YT-7715 | 73          | YT-78133 | 109         | YT-7897  | 110         | YT-80368 | 428         | YT-80586 | 426         | YT-80855 | 427         | YT-81805 | 433         | YT-83051 | 371         |
| YT-7716 | 73          | YT-78134 | 109         | YT-7898  | 110         | YT-80369 | 428         | YT-80587 | 426         | YT-80856 | 427         | YT-81806 | 433         | YT-83052 | 371         |
| YT-7717 | 73          | YT-78135 | 109         | YT-7899  | 110         | YT-80380 | 428         | YT-80588 | 426         | YT-80857 | 427         | YT-81851 | 432         | YT-83060 | 371         |
| YT-7718 | 73          | YT-78136 | 109         | YT-7901  | 110         | YT-80381 | 428         | YT-80589 | 426         | YT-80858 | 427         | YT-81852 | 432         | YT-83061 | 371         |
| YT-7719 | 73          | YT-7814  | 110         | YT-7906  | 110         | YT-80382 | 428         | YT-80590 | 426         | YT-80859 | 427         | YT-81853 | 432         | YT-83062 | 371         |
| YT-7720 | 73          | YT-78141 | 109         | YT-7909  | 110         | YT-80383 | 428         | YT-80591 | 426         | YT-80860 | 427         | YT-81861 | 432         | YT-8310  | 266; 372    |
| YT-7721 | 73          | YT-78142 | 109         | YT-7910  | 110         | YT-80384 | 428         | YT-80733 | 427         | YT-8100  | 260; 438    | YT-81862 | 432         | YT-83101 | 266; 372    |
| YT-7722 | 73          | YT-78143 | 109         | YT-7911  | 110         | YT-80390 | 428         | YT-80734 | 427         | YT-8101  | 260; 438    | YT-81871 | 432         | YT-8311  | 266; 372    |
| YT-7723 | 73          | YT-78144 | 109         | YT-7912  | 110         | YT-80391 | 428         | YT-80735 | 427         | YT-8102  | 260; 438    | YT-82030 | 393         | YT-83150 | 372         |
| YT-7724 | 73          | YT-78145 | 109         | YT-7916  | 110         | YT-80392 | 428         | YT-80736 | 427         | YT-81021 | 260; 438    | YT-82035 | 393         | YT-83151 | 372         |
| YT-7725 | 73          | YT-78146 | 109         | YT-7929  | 110         | YT-80393 | 428         | YT-80737 | 427         | YT-81022 | 260; 438    | YT-82040 | 393         | YT-83152 | 372         |
| YT-7726 | 73          | YT-78147 | 109         | YT-7930  | 110         | YT-80394 | 428         | YT-80738 | 427         | YT-81023 | 260; 438    | YT-82050 | 394         | YT-83153 | 372         |
| YT-7727 | 73          | YT-7815  | 110         | YT-7931  | 110         | YT-80460 | 426         | YT-80739 | 427         | YT-81024 | 260; 438    | YT-82051 | 394         | YT-83160 | 217         |
| YT-7728 | 73          | YT-78150 | 109         | YT-7932  | 110         | YT-80461 | 426         | YT-80740 | 427         | YT-81052 | 261; 439    | YT-82070 | 394         | YT-83161 | 217         |
| YT-7729 | 73          | YT-78151 | 109         | YT-7933  | 110         | YT-80462 | 426         | YT-80741 | 427         | YT-81053 | 261; 439    | YT-82090 | 392         | YT-83162 | 217         |
| YT-7730 | 73          | YT-78152 | 109         | YT-7936  | 110         | YT-80463 | 426         | YT-80761 | 427         | YT-81054 | 261; 439    | YT-82095 | 392         | YT-83163 | 217         |
| YT-7731 | 73          | YT-78153 | 109         | YT-7950  | 110         | YT-80464 | 426         | YT-80762 | 427         | YT-8106  | 261; 439    | YT-82102 | 392         | YT-83164 | 217         |
| YT-7732 | 73          | YT-78154 | 109         | YT-7980  | 110         | YT-80465 | 426         | YT-80763 | 427         | YT-8107  | 261; 439    | YT-82120 | 395         | YT-83165 | 217         |
| YT-7733 | 73          | YT-78155 | 109         | YT-8001  | 163; 458    | YT-80466 | 426         | YT-80764 | 427         | YT-8108  | 261; 439    | YT-82125 | 395         | YT-83166 | 217         |
| YT-7734 | 73          | YT-78156 | 109         | YT-8002  | 163; 458    | YT-80467 | 426         | YT-80765 | 427         | YT-8110  | 260; 438    | YT-82127 | 395         | YT-83167 | 217         |
| YT-7735 | 73          | YT-7816  | 110         | YT-8003  | 163; 458    | YT-80468 | 426         | YT-80766 | 427         | YT-8111  | 260; 438    | YT-82130 | 395         | YT-83168 | 217         |
| YT-7736 | 73          | YT-78160 | 109         | YT-8004  | 163; 458    | YT-80469 | 426         | YT-80767 | 427         | YT-8112  | 260; 438    | YT-82140 | 397         | YT-83169 | 217         |
| YT-7737 | 73          | YT-78161 | 109         | YT-8005  | 163; 458    | YT-80470 | 426         | YT-80768 | 427         | YT-8115  | 260; 438    | YT-82150 | 397         | YT-83180 | 218         |
| YT-7738 | 73          | YT-78162 | 109         | YT-8006  | 163; 458    | YT-80471 | 426         | YT-80769 | 427         | YT-8116  | 260; 438    | YT-82153 | 397         | YT-83181 | 218         |
| YT-7739 | 74          | YT-78163 | 109         | YT-8011  | 163; 458    | YT-80521 | 426         | YT-80783 | 427         | YT-81162 | 260; 438    | YT-82170 | 398         | YT-83182 | 218         |
| YT-7740 | 74          | YT-78164 | 109         | YT-8012  | 163; 458    | YT-80522 | 426         | YT-80784 | 427         | YT-8120  | 261; 439    | YT-82171 | 398         | YT-83183 | 218         |
| YT-7741 | 74          | YT-78165 | 109         | YT-8020  | 429         | YT-80523 | 426         | YT-80785 | 427         | YT-8152  | 152         | YT-82190 | 258; 401    | YT-83184 | 218         |
| YT-7742 | 74          | YT-78166 | 109         | YT-8021  | 429         | YT-80524 | 426         | YT-80786 | 427         | YT-8156  | 152         | YT-82220 | 399         | YT-83185 | 218         |
| YT-7743 | 74          | YT-78167 | 109         | YT-8022  | 429         | YT-80525 | 426         | YT-80787 | 427         | YT-8159  | 152         | YT-82250 | 231; 401    | YT-83186 | 218         |
| YT-7744 | 74          | YT-7817  | 110         | YT-8023  | 429         | YT-80526 | 426         | YT-80788 | 427         | YT-81591 | 152         | YT-82270 | 396         | YT-83187 | 218         |
| YT-7745 | 74          | YT-7818  | 110         | YT-8024  | 429         | YT-80527 | 426         | YT-80789 | 427         | YT-81592 | 152         | YT-82271 | 396         | YT-83188 | 218         |
| YT-7746 | 74          | YT-78190 | 109         | YT-8025  | 429         | YT-80528 | 426         | YT-80790 | 427         | YT-81593 | 152         | YT-82272 | 396         | YT-83189 | 218         |
| YT-7747 | 74          | YT-78191 | 109         | YT-8026  | 429         | YT-80529 | 426         | YT-80791 | 427         | YT-81594 | 152         | YT-82280 | 398         | YT-83190 | 218         |
| YT-7750 | 75          | YT-78192 | 109         | YT-8027  | 429         | YT-80552 | 426         | YT-80794 | 427         | YT-81595 | 152         | YT-82288 | 400         | YT-83200 | 218         |
| YT-7751 | 75          | YT-78193 | 109         | YT-8028  | 429         | YT-80553 | 426         | YT-80795 | 427         | YT-8165  | 152         | YT-82291 | 400         | YT-83201 | 218         |
| YT-7752 | 75          | YT-78194 | 109         | YT-8029  | 429         | YT-80554 | 426         | YT-80796 | 427         | YT-81651 | 152         | YT-82292 | 400         | YT-83202 | 218         |
| YT-7753 | 75          | YT-7826  | 110         | YT-8030  | 429         | YT-80555 | 426         | YT-80797 | 427         | YT-81652 | 152         | YT-82293 | 400         | YT-83203 | 218         |
| YT-7800 | 110         | YT-7829  | 110         | YT-8031  | 429         | YT-80556 | 426         | YT-80798 | 427         | YT-81654 | 152         | YT-82401 | 150; 247;   | YT-83204 | 218         |
| YT-7801 | 110         | YT-7834  | 110         | YT-8032  | 429         | YT-80557 | 426         | YT-80799 | 427         | YT-81655 | 152         | YT-82421 | 150; 247;   | YT-83205 | 218         |
| YT-7802 | 110         | YT-7846  | 110         | YT-8033  | 429         | YT-80558 | 426         | YT-80800 | 427         | YT-8166  | 152         | YT-8245  | 151; 246;   | YT-83206 | 218         |
| YT-7803 | 110         | YT-7847  | 110         | YT-8034  | 429         | YT-80559 | 426         | YT-80801 | 427         | YT-8173  | 152         | YT-82455 | 150; 246;   | YT-83207 | 218         |
| YT-7804 | 110         | YT-7848  | 110         | YT-80355 | 428         | YT-80560 | 426         | YT-80802 | 427         | YT-8174  | 152         | YT-8271  | 151; 246;   | YT-83208 | 218         |



| YATO     | page/strona | YATO     | page/strona | YATO     | page/strona | YATO    | page/strona | YATO     | page/strona | YATO    | page/strona | YATO     | page/strona |
|----------|-------------|----------|-------------|----------|-------------|---------|-------------|----------|-------------|---------|-------------|----------|-------------|
| YT-83209 | 218         | YT-83311 | 219         | YT-83420 | 221         | YT-8350 | 216         | YT-8448  | 216         | YT-8816 | 455         | YT-8966  | 443         |
| YT-83210 | 218         | YT-83312 | 219         | YT-83421 | 221         | YT-8351 | 216         | YT-8449  | 216         | YT-8817 | 456         | YT-8967  | 444         |
| YT-83211 | 218         | YT-83313 | 219         | YT-83422 | 221         | YT-8352 | 216         | YT-8450  | 216         | YT-8821 | 453         | YT-8968  | 445         |
| YT-83220 | 218         | YT-83314 | 219         | YT-83423 | 221         | YT-8353 | 216         | YT-8451  | 216         | YT-8822 | 453         | YT-8970  | 450         |
| YT-83221 | 218         | YT-83315 | 219         | YT-83424 | 221         | YT-8354 | 216         | YT-8452  | 216         | YT-8823 | 453         | YT-8971  | 451         |
| YT-83222 | 218         | YT-83316 | 219         | YT-83425 | 221         | YT-8355 | 216         | YT-8453  | 216         | YT-8824 | 453         | YT-8972  | 451         |
| YT-83223 | 218         | YT-83321 | 219         | YT-83426 | 221         | YT-8356 | 216         | YT-8454  | 216         | YT-8831 | 456         | YT-8973  | 451         |
| YT-83224 | 218         | YT-83322 | 219         | YT-83427 | 221         | YT-8357 | 216         | YT-8455  | 216         | YT-8832 | 456         | YT-8974  | 451         |
| YT-83225 | 218         | YT-83323 | 219         | YT-83428 | 221         | YT-8358 | 216         | YT-8456  | 216         | YT-8833 | 456         | YT-8975  | 451         |
| YT-83226 | 218         | YT-83324 | 219         | YT-83430 | 221         | YT-8360 | 216         | YT-8457  | 216         | YT-8834 | 456         | YT-8976  | 451         |
| YT-83227 | 218         | YT-83325 | 219         | YT-83431 | 221         | YT-8361 | 216         | YT-8458  | 216         | YT-8835 | 456         | YT-8977  | 451         |
| YT-83228 | 218         | YT-83326 | 219         | YT-83432 | 221         | YT-8362 | 216         | YT-8459  | 216         | YT-8836 | 456         | YT-8978  | 452         |
| YT-83229 | 218         | YT-83331 | 219         | YT-83433 | 221         | YT-8363 | 216         | YT-8460  | 216         | YT-8838 | 457         | YT-8979  | 450         |
| YT-83230 | 218         | YT-83332 | 219         | YT-83434 | 221         | YT-8364 | 216         | YT-8461  | 216         | YT-8839 | 457         | YT-8984  | 447         |
| YT-83231 | 218         | YT-83333 | 219         | YT-83435 | 221         | YT-8365 | 216         | YT-8462  | 216         | YT-8840 | 457         | YT-8985  | 447         |
| YT-83232 | 218         | YT-83334 | 219         | YT-83436 | 221         | YT-8366 | 216         | YT-8463  | 216         | YT-8841 | 457         | YT-8986  | 447         |
| YT-83233 | 218         | YT-83335 | 219         | YT-83437 | 221         | YT-8367 | 216         | YT-8464  | 216         | YT-8842 | 457         | YT-8987  | 447         |
| YT-83234 | 218         | YT-83336 | 219         | YT-83438 | 221         | YT-8368 | 216         | YT-8465  | 216         | YT-8843 | 454         | YT-8988  | 448         |
| YT-83235 | 218         | YT-83351 | 220         | YT-83440 | 221         | YT-8370 | 216         | YT-8466  | 216         | YT-8845 | 454         | YT-8991  | 448         |
| YT-83236 | 218         | YT-83352 | 220         | YT-83441 | 221         | YT-8371 | 216         | YT-8480  | 217         | YT-8849 | 454         | YT-8993  | 448         |
| YT-83237 | 218         | YT-83353 | 220         | YT-83442 | 221         | YT-8372 | 216         | YT-8481  | 217         | YT-8850 | 456         | YT-9920  | 452         |
| YT-83238 | 218         | YT-83354 | 220         | YT-83443 | 221         | YT-8373 | 216         | YT-8482  | 217         | YT-8851 | 453         | YT-9940  | 452         |
| YT-83239 | 218         | YT-83355 | 220         | YT-83444 | 221         | YT-8374 | 216         | YT-8483  | 217         | YT-8852 | 453         | YT-9941  | 452         |
| YT-83240 | 218         | YT-83356 | 220         | YT-83445 | 221         | YT-8375 | 216         | YT-8484  | 217         | YT-8853 | 453         | YT-9955  | 449         |
| YT-83251 | 219         | YT-83361 | 220         | YT-83446 | 221         | YT-8376 | 216         | YT-8485  | 217         | YT-8854 | 453         | YT-99801 | 450         |
| YT-83252 | 219         | YT-83362 | 220         | YT-83447 | 221         | YT-8377 | 216         | YT-8486  | 217         | YT-8865 | 459         | YT-99802 | 450         |
| YT-83253 | 219         | YT-83363 | 220         | YT-83448 | 221         | YT-8378 | 216         | YT-85401 | 404         | YT-8866 | 459         | YT-99803 | 450         |
| YT-83254 | 219         | YT-83364 | 220         | YT-83450 | 221         | YT-8400 | 217         | YT-85402 | 404         | YT-8867 | 459         | YT-99804 | 450         |
| YT-83255 | 219         | YT-83365 | 220         | YT-83451 | 221         | YT-8401 | 217         | YT-85403 | 404         | YT-8868 | 459         | YT-99810 | 450         |
| YT-83256 | 219         | YT-83366 | 220         | YT-83452 | 221         | YT-8402 | 217         | YT-85421 | 403         | YT-8869 | 459         | YT-99811 | 450         |
| YT-83271 | 219         | YT-83371 | 220         | YT-83453 | 221         | YT-8403 | 217         | YT-85422 | 403         | YT-8870 | 459         | YT-99812 | 451         |
| YT-83272 | 219         | YT-83372 | 220         | YT-83454 | 221         | YT-8404 | 217         | YT-85432 | 402         | YT-8876 | 457         | YT-99813 | 451         |
| YT-83273 | 219         | YT-83373 | 220         | YT-83455 | 221         | YT-8405 | 217         | YT-85434 | 402         | YT-8885 | 459         | YT-99814 | 451         |
| YT-83274 | 219         | YT-83374 | 220         | YT-83456 | 221         | YT-8406 | 217         | YT-85437 | 402         | YT-8886 | 459         | YT-99815 | 451         |
| YT-83275 | 219         | YT-83375 | 220         | YT-83457 | 221         | YT-8407 | 217         | YT-85440 | 402         | YT-8889 | 459         | YT-99821 | 452         |
| YT-83276 | 219         | YT-83376 | 220         | YT-83458 | 221         | YT-8408 | 217         | YT-8603  | 461         | YT-8890 | 459         | YT-99825 | 450         |
| YT-83281 | 219         | YT-83381 | 220         | YT-83480 | 221         | YT-8409 | 217         | YT-86800 | 461         | YT-8891 | 459         | YT-99826 | 450         |
| YT-83282 | 219         | YT-83382 | 220         | YT-83481 | 221         | YT-8410 | 217         | YT-86801 | 461         | YT-8892 | 459         | YT-99827 | 450         |
| YT-83283 | 219         | YT-83383 | 220         | YT-83482 | 221         | YT-8411 | 217         | YT-86804 | 461         | YT-8894 | 460         | YT-99828 | 450         |
| YT-83284 | 219         | YT-83384 | 220         | YT-83483 | 221         | YT-8412 | 217         | YT-86805 | 461         | YT-8940 | 452         | YT-99830 | 447         |
| YT-83285 | 219         | YT-83385 | 220         | YT-83484 | 221         | YT-8413 | 217         | YT-86808 | 461         | YT-8941 | 452         | YT-99833 | 443         |
| YT-83286 | 219         | YT-83386 | 220         | YT-83485 | 221         | YT-8414 | 217         | YT-86809 | 461         | YT-8943 | 452         | YT-99834 | 443         |
| YT-83291 | 219         | YT-83390 | 220         | YT-83486 | 221         | YT-8415 | 217         | YT-8790  | 454         | YT-8950 | 447         | YT-99840 | 445         |
| YT-83292 | 219         | YT-83391 | 220         | YT-83487 | 221         | YT-8416 | 217         | YT-8791  | 455         | YT-8955 | 443         | YT-99841 | 445         |
| YT-83293 | 219         | YT-83392 | 220         | YT-83488 | 221         | YT-8417 | 217         | YT-8792  | 455         | YT-8956 | 443         | YT-99843 | 446; 449    |
| YT-83294 | 219         | YT-83393 | 220         | YT-83490 | 221         | YT-8418 | 217         | YT-8800  | 454         | YT-8957 | 444         | YT-99845 | 448         |
| YT-83295 | 219         | YT-83394 | 220         | YT-83491 | 221         | YT-8440 | 216         | YT-8801  | 454         | YT-8958 | 444         | YT-99848 | 452         |
| YT-83296 | 219         | YT-83395 | 220         | YT-83492 | 221         | YT-8441 | 216         | YT-8802  | 455         | YT-8959 | 444         | YT-99850 | 442         |
| YT-83301 | 219         | YT-83396 | 220         | YT-83493 | 221         | YT-8442 | 216         | YT-8805  | 454         | YT-8960 | 445         | YT-99852 | 442         |
| YT-83302 | 219         | YT-83397 | 220         | YT-83494 | 221         | YT-8443 | 216         | YT-8807  | 455         | YT-8961 | 445; 449    | YT-99853 | 442         |
| YT-83303 | 219         | YT-83398 | 220         | YT-83495 | 221         | YT-8444 | 216         | YT-8808  | 455         | YT-8962 | 446; 449    |          |             |
| YT-83304 | 219         | YT-83399 | 220         | YT-83496 | 221         | YT-8445 | 216         | YT-8809  | 455         | YT-8963 | 444         |          |             |
| YT-83305 | 219         | YT-83400 | 220         | YT-83497 | 221         | YT-8446 | 216         | YT-8811  | 454         | YT-8964 | 444         |          |             |
| YT-83306 | 219         | YT-83401 | 220         | YT-83498 | 221         | YT-8447 | 216         | YT-8815  | 455         | YT-8965 | 443         |          |             |

## PL

I. TOYA S.A. informuje, iż: 1) niniejszy katalog nie stanowi oferty w rozumieniu prawa cywilnego; 2) prezentowane w niniejszym katalogu artykuły mogą w rzeczywistości odbiegać od wskazanego na zdjęciach wzoru, w szczególności jeżeli chodzi o cechy zewnętrzne, tj. wielkość, kolor, sposób opakowania, ilość przedmiotów w opakowaniu; 3) nie ponosi odpowiedzialności za drobne różnice w sposobie pakowania czy właściwościach artykułów pozostających bez wpływu na jego przeznaczony cel lub sposób użytkowania; 4) nie ponosi odpowiedzialności wynikającej z jakichkolwiek niedokładności lub nieścisłości, co do informacji zawartych w przedmiotowym katalogu; 5) nie ponosi odpowiedzialności za ewentualną szkodę powstałą w wyniku otrzymania towaru o innych właściwościach niż prezentowany na zdjęciach.

II. Pomimo najlepszych starań poczynionych przez TOYA S.A. nie może ona zagwarantować, iż informacje zawarte w niniejszym katalogu w pełni odpowiadają rzeczywistości.

III. Wszelkie decyzje podjęte na podstawie informacji zawartych w przedmiotowym katalogu podejmowane są na własne ryzyko osoby, która korzysta z tych informacji.

## GB

I. TOYA S.A. informs that: 1) the present catalogue does not constitute an offer as construed in the civil law; 2) the goods presented in the present catalogue may in fact differ from the models shown in the pictures, particularly as far as external properties are concerned, namely size, colour, packaging, number of items in the package; 3) the company will not be held responsible for small differences in packaging or properties of the goods, which do not affect the purpose or the exploitation of the tools; 4) the company will not be held responsible for any inaccuracies or imprecision regarding the information presented in the catalogue; 5) the company will not be held responsible for any damage caused by goods whose properties differ from those of the tools presented in the photographs.

II. In spite of all the efforts made by TOYA S.A., the company cannot guarantee the information contained in the present catalogue fully correspond to the reality.

III. Any decisions made on the basis of the information contained in the present catalogue will be made at the risk of the person who makes them using the aforementioned information.

## D

I. TOYA S.A. informiert, dass: 1) der vorliegende Katalog kein Angebot im zivilrechtlichen Sinne darstellt; 2) die im vorliegenden Katalog präsentierten Artikel in der Realität von den auf den Musterfotos gezeigten abweichen können, und zwar besonders dann, wenn es um äußere Eigenschaften geht, wie z.B. Größe, Farbe, Art der Verpackung, Anzahl der Gegenstände in der Verpackung; 3) sie keine Verantwortung für geringfügige Unterschiede bei der Verpackungsart oder den Eigenschaften der Artikel übernimmt, die ohne Auswirkungen auf seinen Bestimmungszweck oder die Art der Nutzung bleiben; 4) sie keine Verantwortung für irgendwelche Oberflächlichkeiten und Ungenauigkeiten bzgl. der im Sachkatalogkatalog enthaltenen Informationen übernimmt; 5) sie keine Verantwortung für eventuelle Schäden, die im Ergebnis des Erhalts der Ware mit anderen als auf den Fotos dargestellten Eigenschaften entstanden sind, übernimmt.

II. Trotz großer Bemühungen seitens TOYA S.A. kann die Firma nicht garantieren, dass die im vorliegenden Katalog enthaltenen Informationen voll der Realität entsprechen.

III. Sämtliche Entscheidungen, die auf der Grundlage der im Sachkatalog enthaltenen Informationen getroffen wurden, gehen auf das Risiko der Person, die diese Informationen benutzt.

## RUS

I. TOYA S.A. заявляет: 1) настоящий каталог не является торговым предложением с точки зрения гражданского законодательства; 2) изделия, представленные в настоящем каталоге, могут отличаться от образцов на снимках, особенно внешним видом, то есть размером, цветом, способом упаковки, количеством предметов в упаковке; 3) производитель не отвечает за мелкие отличия в способе упаковки или свойствах изделий, которые не влияют на предназначение или способ пользования изделиями; 4) производитель не отвечает за мелкие неточности в сведениях из предметного каталога; 5) производитель не отвечает за ущерб, нанесенный вследствие поставки товара, отличающегося параметрами от указанного на снимках.

II. Несмотря на все усилия в данном направлении, компания TOYA S.A. не гарантирует, что информация, метящаяся в настоящем каталоге, полностью отвечает действительности.

III. Риск, связанный с любыми решениями, принятыми на основании информации из предметного каталога, берут на себя лица, пользующиеся указанной информацией.

## CZ

I. TOYA S.A. informuje že: 1) tento katalog nepředstavuje nabídku ve smyslu občanského práva; 2) výrobky prezentované v tomto katalogu se mohou ve skutečnosti lišit od modelů uvedených na obrázcích, zejména co se týká vnějších znaků, tj. velikosti, barvy, způsobu balení, počtu předmětů v balení; 3) nenese odpovědnost za drobné rozdíly ve způsobu balení nebo ve vlastnostech výrobků, které nemají zásadní vliv na jejich určený účel nebo způsob používání; 4) nenese odpovědnost vyplývající z jakýchkoli nepřesností co do informací uvedených v předmětném katalogu; 5) nenese odpovědnost za případné škody vzniklé v důsledku obdržení zboží s jinými vlastnostmi, než je uvedeno na obrázcích.

II. Navzdory mimořádnému úsilí vynaloženému firmou TOYA S.A. tato nemůže garantovat, zda informace uvedené v tomto katalogu zcela odpovídají skutečnosti.

III. Veškerá rozhodnutí přijatá na základě informací uvedených v předmětném katalogu jsou přijímána na vlastní riziko osoby, která tyto informace využívá.

## H

I. A TOYA S.A. tájékoztatja, hogy: 1) a jelen katalógus a polgári jog szerint nem kereskedelmi ajánlat; 2) a jelen katalógusban bemutatott árucikkek a valóságban eltérhetnek a képeken látható mintáktól, különösen a külső tulajdonságok, mint a méret, szín, csomagolási mód, a csomagban lévő tárgyak száma tekintetében; 3) nem vállal felelősséget a csomagolás módjában vagy az árucikkek olyan tulajdonságaiban történt változtatásokért, amelyek nem befolyásolják lényeges módon annak rendeltetését vagy a felhasználás módját; 4) nem vállal felelősséget a jelen katalógusban lévő információk pontatlanságáért; 5) nem vállal felelősséget azokért az esetleges károkért, amik az árucikkek a fényképeken látható tulajdonságoktól eltérő tulajdonságokkal történő leszállításából erednek.

II. A TOYA S.A. minden igyekezete ellenére nem tudja garantálni, hogy a jelen katalógusban található információk teljes egészében megfelelnek a valóságnak.

III. A tárgyi katalógusban található információk alapján meghozott bármilyen döntés annak a személynek a rizikója, aki ezeket az információkat felhasználja.

## RO

I. TOYA S.A. informează că: 1) prezentul catalog nu constituie ofertă în înțelesul dreptului civil; 2) articolele prezentate în prezentul catalog se pot diferi față de mostrele din fotografiile, în special aspectul exterior, adică mărimea, culoarea, modul de ambalare, cantitatea obiectelor în ambalaj; 3) nu-și asumă răspunderea referitor la mici diferențe la modul de ambalare sau la articolele al căror proprietăți nu au influență referitor la destinația sau modul lor de utilizare; 4) nu-și asumă răspunderea referitor la orice inexactitate sau imprecizie, datorită informațiilor cuprinse în catalogul respectiv; 5) nu-și asumă răspunderea referitor la o eventuală pagubă ca urmarea primirii marfei cu alte proprietăți decât cele prezentate pe fotografiile; 6) Cu toate strădaniile TOYA S.A., firma nu poate garanta că, informațiile din prezentul catalog corespund realității;

III. Orice decizie preluată în baza informațiilor cuprinse în catalogul respectiv, sunt preluate pe riscul și răspunderea persoanei care a făcut folos de aceste informații.

## E

I. TOYA S.A. comunica lo siguiente: 1) el presente catálogo no constituye una oferta, en el sentido que la noción adquiere en la ley civil; 2) los artículos presentados en el presente catálogo pueden en realidad diferir de los modelos indicados en las fotografías, especialmente en cuanto a sus propiedades externas, es decir el tamaño, el color, el empaque o la cantidad de los objetos en el empaque; 3) la empresa no se hace responsable por pequeñas diferencias en cuanto al empaque o las propiedades de los artículos, siempre y cuando estas diferencias no afectan el propósito o el modo de operación de las herramientas; 4) la empresa no se hace responsable por ninguna imprecisión en cuanto a la información presentada en el presente catálogo; 5) la empresa no se hace responsable por ningún daño que surja del hecho de que los artículos recibidos difieran de los artículos presentados en las fotografías en cuanto a sus propiedades.

II. A pesar de los mejores intentos de parte TOYA S.A. la empresa no puede garantizar que la información presentada en el presente catálogo corresponda completamente a la realidad.

III. Todas las decisiones tomadas en base a la información presentada en el presente son responsabilidad de la persona que recurra a la dicha información.





**MANUFACTURER / PRODUCENT**

TOYA S.A.  
ul. Sołtysowicka 13-15  
51-168 Wrocław  
☎ (+48 71) 32 46 200  
fax: (+48 71) 32 46 370  
sales@yato.pl (sale)  
export@yato.pl (export)  
import@yato.pl (import)

ODDZIAŁ WARSZAWSKI  
Teren ProLogis Park Nadarzyn  
al. Kasztanowa 160  
05-831 Młochów k. Warszawy  
☎ (+48 22) 73 82 800  
☎ (+48 22) 73 82 828  
sales@yato.pl (sale)  
export@yato.pl (export)

TOYA ROMANIA S.A.  
Sos. Odăi Nr. 109-12  
Sector 1, București  
☎ 0040 031 710 8692  
office@yato.ro

YATO TOOLS (SHANGHAI) Co., Ltd  
Building #28, No. 1365 lane  
East KangQiao Road  
201315 Shanghai  
☎ (+86 21) 209 811 07  
fax: (+86 21) 209 811 08  
yato@yato-sh.com

**YOUR TRUSTED SUPPLIER: / TWÓJ ZAUFANY DOSTAWCA:**



**www.yato.com**

COPYRIGHT © TOYA S.A. 2015

**GET ACQUAINTED WITH OUR WIDE OFFER:  
ZOBACZ NASZĄ BOGATĄ OFERTĘ:**

