

POWERPLUS

WATER

POWERPLUS
DESIGNED AND MARKETED BY VARD *Water*

GARDENPRO
POWERPLUS[®]
HIGH QUALITY TOOLS

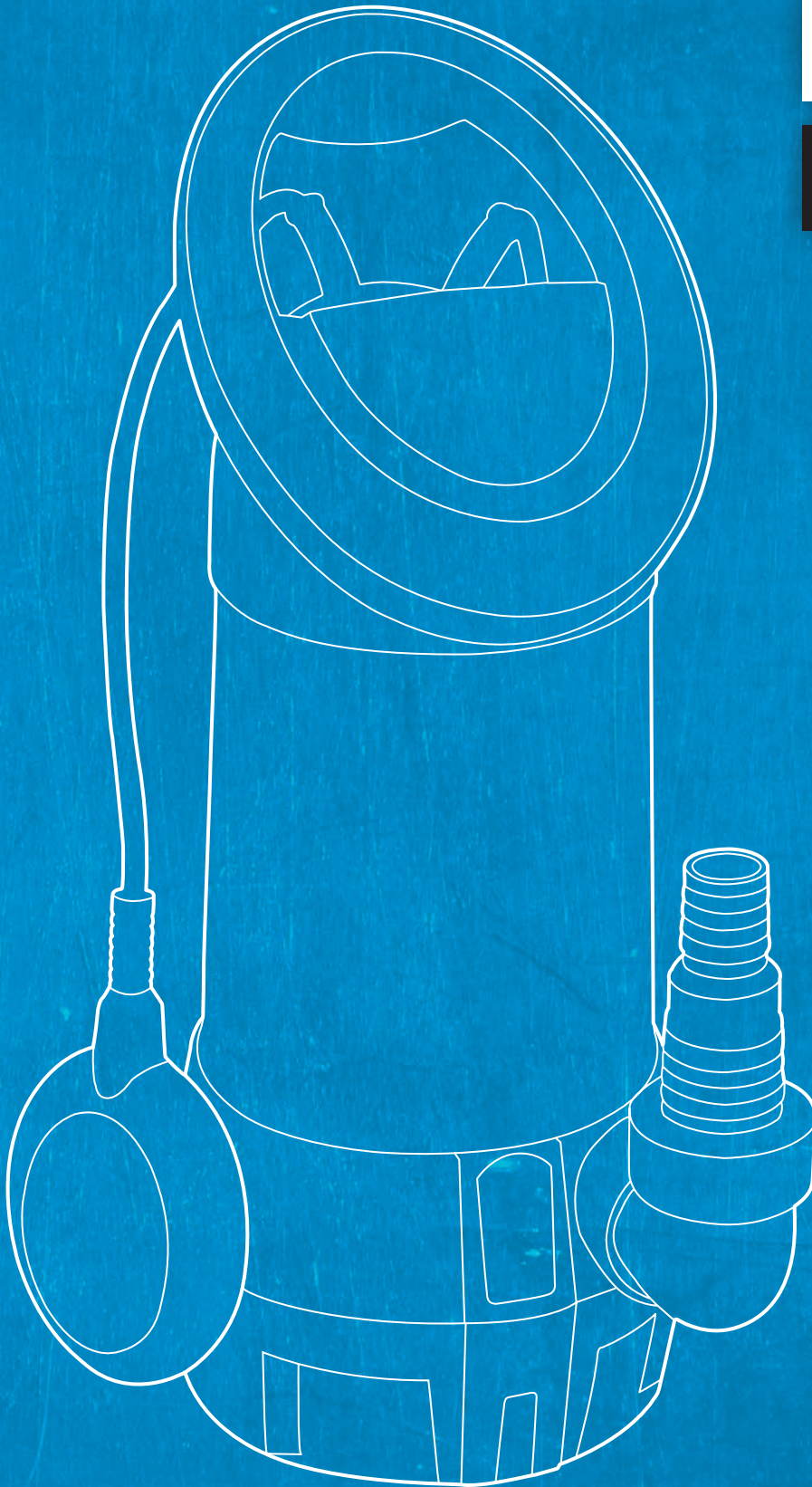



Index

POWERPLUS
DESIGNED AND MARKETED BY VARD *Water*

24
MONTHS
WARRANTY

GARDENPRO
POWERPLUS
HIGH QUALITY TOOLS



Submersible pumps

POW67900	submersible pump	200W	p. 2
POW67902	submersible pump	250W	p. 3
POW67904	submersible pump	400W	p. 3
POW67906	submersible pump	750W	p. 4
POW67920	submersible pump	750W	p. 4
POW67912	submersible pump	400W	p. 5
POW67915	submersible pump	900W	p. 5

Garden pump

POW67930	garden pump	800W	p. 6
----------	-------------	------	------

Pressure pump

POW67935	pressure pump	1000W	p. 7
----------	---------------	-------	------

High Pressure cleaners

POWXG9020	high pressure cleaner	1500W	p. 8
POWXG9025	high pressure cleaner	1900W	p. 8
POWXG9030	high pressure cleaner	1900W	p. 9
POWXG90905	soap bottle		p. 9
POWXG90910	adjustable nozzle		p. 9
POWXG90911	turbo nozzle		p. 9
POWXG90912	angle nozzle		p. 9
POWXG90920	patio cleaner		p. 9
POWXG90925	brush		p. 9
POWXG90930	pipe cleaning set		p. 9
POWXG9006	high pressure cleaner	163cc	p. 10
POWXG9007	high pressure cleaner	196cc	p. 11

Submersible pumps

POWXG9402	submersible pump	400W	p. 12
POWXG9404	submersible pump	550W	p. 13
POWXG9407	submersible pump	850W	p. 13
POWXG9412	submersible pump	750W	p. 14
POWXG9416	submersible pump	550W	p. 15
POWXG9417	submersible pump	750W	p. 15
POWXG9418	submersible pump	900W	p. 16
POWXG9427	submersible pump	1100W	p. 16

Garden pumps

POWXG9442	garden pump	800W	p. 17
POWXG9445	garden pump	1000W	p. 18
POWXG9447	automatic garden pump	1200W	p. 18

Pressure pumps

POWXG9451	pressure pump	800W	p. 19
POWXG9453	pressure pump	1200W	p. 20
POWXG9456	pressure pump	1200W	p. 20

Accessories

POW67F	outlet submersible pump	female	p. 21
POW68M	outlet garden pump	male	p. 21
POWXG94AH	aspiration hose	1" - 8m	p. 21
POWXG94F1	filter	1 litre	p. 21



CLEAN
water

200W

MAX. SUBMERSIBLE DEPTH
5m



MODEL	POW67900
Voltage / frequency	230V~ 50Hz
Power	200W
Max. delivery rate	3500 l/h
Max. pressure height	5m
Max. submersible depth	5m
Max. water temperature	35° C
For clean/dirty water	clean
Barcode	 5 400338 060229 >

SPECIFICATIONS

- 10m ELECTRIC CABLE (RNF) WITH EARTHED PLUG
- CARRYING HANDLE
- FLOATING SWITCH
- POLYPROPYLENE PUMP HOUSING
- LEAVES ONLY 5mm WATER BEHIND

24
MONTHS
WARRANTY

CLEAN
water

250W

MAX.
SUBMERSIBLE
DEPTH
5m



MODEL	POW67902
Voltage / frequency	230V~ 50Hz
Power	250W
Max. delivery rate	5000 l/h
Max. pressure height	5m
Max. submersible depth	5m
Max. water temperature	35° C
For clean/dirty water	clean
Barcode	 5 400338 059902 >

SPECIFICATIONS

- 10m ELECTRIC CABLE (RNF) WITH EARTHED PLUG
- CARRYING HANDLE
- FLOATING SWITCH
- POLYPROPYLENE PUMP HOUSING
- LEAVES ONLY 5mm WATER BEHIND

DIRTY
WATER

400W

MAX.
SUBMERSIBLE
DEPTH
5m



MODEL	POW67904
Voltage / frequency	230V~ 50Hz
Power	400W
Max. delivery rate	7500 l/h
Max. pressure height	5m
Max. submersible depth	5m
Max. water temperature	35° C
For clean/dirty water	dirty
Barcode	 5 400338 060236 >

SPECIFICATIONS

- 10m ELECTRIC CABLE (RNF) WITH EARTHED PLUG
- CARRYING HANDLE
- FLOATING SWITCH
- POLYPROPYLENE PUMP HOUSING

**DIRTY
WATER**

750W

MAX.
SUBMERSIBLE
DEPTH
7m



MODEL	POW67906
Voltage / frequency	230V~ 50Hz
Power	750W
Max. delivery rate	13000 l/h
Max. pressure height	8m
Max. submersible depth	7m
Max. water temperature	35° C
For clean/dirty water	dirty
Barcode	 5 400338 060243 >

SPECIFICATIONS

- 10m ELECTRIC CABLE (RNF) WITH EARTHED PLUG
- CARRYING HANDLE
- FLOATING SWITCH
- POLYPROPYLENE PUMP HOUSING

**CLEAN
water**

750W

MAX.
SUBMERSIBLE
DEPTH
7m



MODEL	POW67920
Voltage / frequency	230V~ 50Hz
Power	750W
Max. delivery rate	12500 l/h
Max. pressure height	8,5m
Max. submersible depth	7m
Max. water temperature	35° C
For clean/dirty water	clean
Barcode	 5 400338 060298 >

SPECIFICATIONS

- 10m ELECTRIC CABLE (RNF) WITH EARTHED PLUG
- CARRYING HANDLE
- BUILT-IN SWITCH
- POLYPROPYLENE PUMP HOUSING
- LEAVES ONLY 5mm WATER BEHIND

24
MONTHS
WARRANTY

DIRTY
WATER

400W

MAX.
SUBMERSIBLE
DEPTH
5m



MODEL	POW67912
Voltage / frequency	230V~ 50Hz
Power	400W
Max. delivery rate	7500 l/h
Max. pressure height	5m
Max. submersible depth	5m
Max. water temperature	35° C
For clean/dirty water	dirty
Barcode	 5 400338 060250 >



SPECIFICATIONS

- 10m ELECTRIC CABLE (RNF) WITH EARTHED PLUG
- CARRYING HANDLE
- FLOATING SWITCH
- STAINLESS STEEL PUMP HOUSING

DIRTY
WATER

900W

MAX.
SUBMERSIBLE
DEPTH
7m



MODEL	POW67915
Voltage / frequency	230V~ 50Hz
Power	900W
Max. delivery rate	13000 l/h
Max. pressure height	9m
Max. submersible depth	7m
Max. water temperature	35° C
For clean/dirty water	dirty
Barcode	 5 400338 060267 >



SPECIFICATIONS

- 10m ELECTRIC CABLE (RNF) WITH EARTHED PLUG
- CARRYING HANDLE
- FLOATING SWITCH
- STAINLESS STEEL PUMP HOUSING

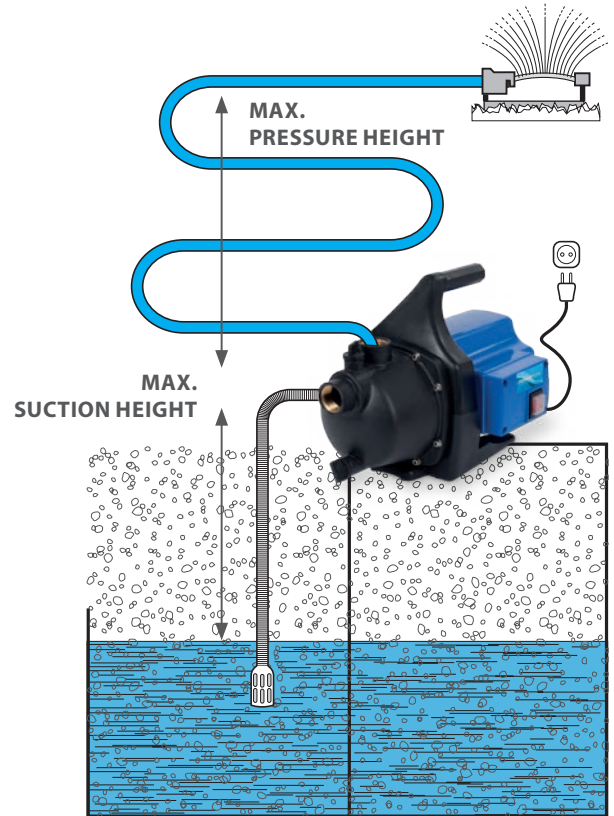

**CLEAN
water**

800W

MAX.
PRESSURE
HEIGHT
40m



MODEL	POW67930
Voltage / frequency	230V~ 50Hz
Power	800W
Rated pressure	4bar
Max. pump capacity	3200 l/h
Max. suction height	7m
Max. pressure height	40m
Max. water temperature	35° C
For clean/dirty water	clean
Barcode	 5 400338 060274 >

SPECIFICATIONS

- 1.2m ELECTRIC CABLE WITH EARTHED PLUG
- CARRYING HANDLE
- ATTENTION: FILL PUMP HOUSING BEFORE FIRST USE

Pressure pump

HYDROFOORGROEP - GROUPE HYDROPHORE - DRUCKPUMPE - BOMBA DE PRESIÓN



MAX. PRESSURE HEIGHT

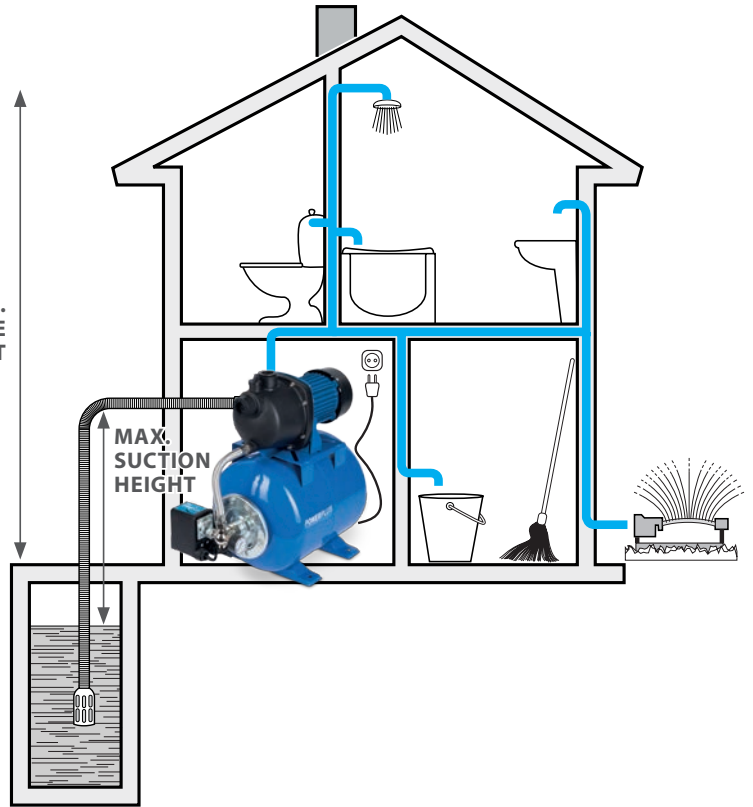

CLEAN water

1000W

MAX. PRESSURE HEIGHT
44m

STEEL TANK CAPACITY
20L



MODEL	POW67935
Voltage / frequency	230V~ 50Hz
Power	1000W
Tank capacity	20 l
Rated pressure	4.4bar
Max. pump capacity	3500 l/h
Max. suction height	7m
Max. pressure height	44m
Max. water temperature	35° C
For clean/dirty water	clean
Barcode	 5 400338 060281 >

SPECIFICATIONS
<ul style="list-style-type: none"> • 1.2m ELECTRIC CABLE WITH EARTHED PLUG • STEEL PRESSURE TANK 20 LITRES • ATTENTION: FILL PUMP HOUSING BEFORE FIRST USE

1500W

MAX. PRESSURE
105bar

360
 L/HOUR



1900W

MAX. PRESSURE
135bar

390
 L/HOUR



MODEL	POWXG9020
Voltage / frequency	230V~ 50Hz
Power	1500W
Rated pressure	70bar
Max. pressure	105bar
Water consumption	360 l/h
Detergent suction	YES
Pressure hose	3m



Barcode



MODEL	POWXG9025
Voltage / frequency	230V~ 50Hz
Power	1900W
Rated pressure	90bar
Max. pressure	135bar
Water consumption	390 l/h
Detergent suction	YES
Pressure hose	3m



Barcode



START/STOP SYSTEM

SPECIFICATIONS

- 5m CABLE
- EXTENDED LANCE FOR GUN
- SOAP BOTTLE
- ADJUSTABLE NOZZLE + TURBO NOZZLE
- MALE WATER INLET CONNECTOR
- PATIO CLEANER

START/STOP SYSTEM

SPECIFICATIONS

- 5m CABLE
- EXTENDED LANCE FOR GUN
- SOAP BOTTLE
- ADJUSTABLE NOZZLE + TURBO NOZZLE
- MALE WATER INLET CONNECTOR
- PATIO CLEANER



1900W

MAX. PRESSURE
135bar

390
L/HOUR



MODEL	POWXG90905 Soap bottle
Quick connection	YES
Detergent suction	YES

Barcode	  5 400338 053252 >
---------	---

MODEL	POWXG90910 Adjustable nozzle
Quick connection	YES

Barcode	  5 400338 053269 >
---------	---



MODEL	POWXG90911 Turbo nozzle
Quick connection	YES

Barcode	  5 400338 053276 >
---------	---

MODEL	POWXG90912 Angle nozzle
Quick connection	YES

Barcode	  5 400338 053283 >
---------	---

MODEL	POWXG90920 Patio cleaner
Quick connection	YES

Barcode	  5 400338 053290 >
---------	---

MODEL	POWXG90925 Brush
Quick connection	YES

Barcode	  5 400338 053306 >
---------	---

MODEL	POWXG90930 Pipe cleaning set
Pressure hose	10m

Barcode	  5 400338 053313 >
---------	---

MODEL	POWXG9030
-------	------------------

Voltage / frequency	230V~ 50Hz
Power	1900W
Rated pressure	90bar
Max. pressure	135bar
Water consumption	390 l/h
Detergent suction	YES
Pressure hose	5m



Barcode	 5 400338 053245 >
---------	--

START/STOP SYSTEM

SPECIFICATIONS

- 5m CABLE
- EXTENDED LANCE FOR GUN
- SOAP BOTTLE
- ADJUSTABLE NOZZLE + TURBO NOZZLE + **ANGLE NOZZLE**
- MALE WATER INLET CONNECTOR
- PATIO CLEANER
- **BRUSH**

163cc

MAX. PRESSURE
200bar



AUTOMATIC
 DETERGENT
 ASPIRATION



LANCE HOOK FOR
 7.5m HOSE

**OIL
 NOT
 INCLUDED**



MODEL	POWXG9006
Cylinder capacity	163cc
Power	4.0kW / 5.5HP
Engine	OHV 4-STROKE
Rated pressure	150bar
Max. pressure	200bar
Water consumption	600 l/h
Detergent suction	YES
Pressure hose	7.5m
Pump house material	brass
Barcode	 5 400338 030857 >

**UNLEADED
 GASOLINE**

SPECIFICATIONS

- METAL ADJUSTABLE SPRAY GUN
- ADJUSTABLE SPRAY PATTERN (4 NOZZLES)
 - 0° pencil spray (persistent dirt)
 - 15° spray pattern (paint removal)
 - 40° (cleaning car, boat,...)
 - low pressure (detergent application)
- SOAP BOTTLE INCL.





196cc

MAX. PRESSURE
240bar



AUTOMATIC
DETERGENT
ASPIRATION



HOSE REEL
WITH 12m HOSE



**OIL
NOT
INCLUDED**



MODEL	POWXG9007
Cylinder capacity	196cc
Power	4.8kW / 6.5HP
Engine	OHV 4-STROKE
Rated pressure	190bar
Max. pressure	240bar
Water consumption	600 l/h
Detergent suction	YES
Pressure hose	12m
Pump house material	brass
Barcode	 5 400338 030864 >

**UNLEADED
GASOLINE**

SPECIFICATIONS

- METAL ADJUSTABLE SPRAY GUN
- ADJUSTABLE SPRAY PATTERN (4 NOZZLES)
 - 0° pencil spray (persistent dirt)
 - 15° spray pattern (paint removal)
 - 40° (cleaning car, boat,...)
 - low pressure (detergent application)
- SOAP BOTTLE INCL.





**CLEAN
 WATER**

400W

MAX. SUBMERSIBLE
 DEPTH
8m

**MECHANICAL
 SEAL**

**STAINLESS
 STEEL AXLE**



MODEL	POWXG9402
Voltage / frequency	230V~ 50Hz
Power	400W
Max. pump capacity	7000 l/h
Max. pressure height	8m
Max. submersible depth	8m
Max. water temperature	35° C
For clean/dirty water	clean

Barcode



SPECIFICATIONS

- 10m ELECTRIC CABLE (RNF) WITH EARTHED PLUG
- CARRYING HANDLE
- FLOATING SWITCH
- POLYPROPYLENE PUMP HOUSING



DIRTY WATER

550W

MAX. SUBMERSIBLE DEPTH
8m

MECHANICAL SEAL

STAINLESS STEEL AXLE



MODEL	POWXG9404
Voltage / frequency	230V~ 50Hz
Power	550W
Max. pump capacity	10000 l/h
Max. pressure height	7m
Max. submersible depth	8m
Max. water temperature	35° C
For clean/dirty water	dirty
Barcode	 5 400338 040337 >

SPECIFICATIONS

- 10m ELECTRIC CABLE (RNF) WITH EARTHED PLUG
- CARRYING HANDLE
- FLOATING SWITCH
- POLYPROPYLENE PUMP HOUSING

DIRTY WATER

850W

MAX. SUBMERSIBLE DEPTH
8m

MECHANICAL SEAL

STAINLESS STEEL AXLE



MODEL	POWXG9407
Voltage / frequency	230V~ 50Hz
Power	850W
Max. pump capacity	13500 l/h
Max. pressure height	8m
Max. submersible depth	8m
Max. water temperature	35° C
For clean/dirty water	dirty
Barcode	 5 400338 040344 >

SPECIFICATIONS

- 10m ELECTRIC CABLE (RNF) WITH EARTHED PLUG
- CARRYING HANDLE
- FLOATING SWITCH
- POLYPROPYLENE PUMP HOUSING



CLEAN WATER

750W

MAX. SUBMERSIBLE DEPTH
8m

MECHANICAL SEAL

STAINLESS STEEL AXLE



MODEL	POWXG9412
Voltage / frequency	230V~ 50Hz
Power	750W
Max. pump capacity	11000 l/h
Max. pressure height	8.5m
Max. submersible depth	8m
Max. water temperature	35° C
For clean/dirty water	clean

Barcode



SPECIFICATIONS

- 10m ELECTRIC CABLE (RNF) WITH EARTHED PLUG
- CARRYING HANDLE
- FLOATING SWITCH
- STAINLESS STEEL PUMP HOUSING



DIRTY WATER

550W

MAX. SUBMERSIBLE DEPTH
8m

MECHANICAL SEAL

STAINLESS STEEL AXLE



MODEL	POWXG9416
Voltage / frequency	230V~ 50Hz
Power	550W
Max. pump capacity	9500 l/h
Max. pressure height	7m
Max. submersible depth	8m
Max. water temperature	35° C
For clean/dirty water	dirty
Barcode	 5 400338 040368 >

SPECIFICATIONS

- 10m ELECTRIC CABLE (RNF) WITH EARTHED PLUG
- CARRYING HANDLE
- FLOATING SWITCH
- STAINLESS STEEL PUMP HOUSING

DIRTY WATER

750W

MAX. SUBMERSIBLE DEPTH
7m

MECHANICAL SEAL

STAINLESS STEEL AXLE



SENSOR SWITCH

MODEL	POWXG9417
Voltage / frequency	230V~ 50Hz
Power	750W
Max. pump capacity	13500 l/h
Max. pressure height	7.5m
Max. submersible depth	7m
Max. water temperature	35° C
For clean/dirty water	dirty
Barcode	 5 400338 042744 >

SPECIFICATIONS

- 10m ELECTRIC CABLE (RNF) WITH EARTHED PLUG
- CARRYING HANDLE
- SENSOR SWITCH
- STAINLESS STEEL PUMP HOUSING

**DIRTY
 WATER**

900W

MAX.
 SUBMERSIBLE
 DEPTH
8m

**MECHANICAL
 SEAL**

**STAINLESS
 STEEL AXLE**



MODEL	POWXG9418
Voltage / frequency	230V~ 50Hz
Power	900W
Max. pump capacity	13500 l/h
Max. pressure height	9m
Max. submersible depth	8m
Max. water temperature	35° C
For clean/dirty water	dirty
Barcode	5 400338 040375 >

SPECIFICATIONS

- 10m ELECTRIC CABLE (RNF) WITH EARTHED PLUG
- CARRYING HANDLE
- FLOATING SWITCH
- STAINLESS STEEL PUMP HOUSING

**DIRTY
 WATER**

1100W

MAX.
 SUBMERSIBLE
 DEPTH
8m

**MECHANICAL
 SEAL**

**STAINLESS
 STEEL AXLE**



MODEL	POWXG9427
Voltage / frequency	230V~ 50Hz
Power	1100W
Max. pump capacity	20000 l/h
Max. pressure height	8m
Max. submersible depth	8m
Max. water temperature	35° C
For clean/dirty water	dirty
Barcode	5 400338 040382 >

SPECIFICATIONS

- 10m ELECTRIC CABLE (RNF) WITH EARTHED PLUG
- CARRYING HANDLE
- FLOATING SWITCH
- STAINLESS STEEL PUMP HOUSING

Garden pumps

TUINPOMPEN - POMPES DE JARDIN - GARTENPUMPEN - BOMBAS DE JARDÍN



**BUILT-IN
FILTER**

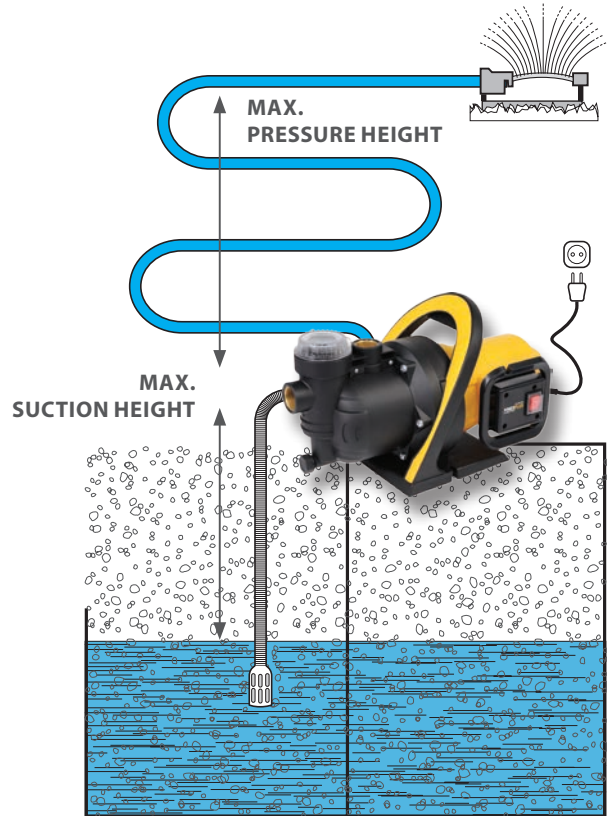

**CLEAN
WATER**

800W

**MAX.
PRESSURE
HEIGHT
40m**

**MECHANICAL
SEAL**

**STAINLESS
STEEL AXLE**



MODEL	POWXG9442
Voltage / frequency	230V~ 50Hz
Power	800W
Rated pressure	4bar
Max. pump capacity	3200 l/h
Max. suction height	7m
Max. pressure height	40m
Max. water temperature	35° C
For clean/dirty water	clean
Barcode	 5 400338 041952 >

SPECIFICATIONS

- 1.2m ELECTRIC CABLE (RNF) WITH EARTHED PLUG
- CARRYING HANDLE
- ABS MOTOR HOUSING
- BUILT-IN FILTER
- NYLON PUMP HEAD

**CLEAN
water**

1000W

MAX.
PRESSURE
HEIGHT
44m

**MECHANICAL
SEAL**

**STAINLESS
STEEL AXLE**



MODEL	POWXG9445
Voltage / frequency	230V~ 50Hz
Power	1000W
Rated pressure	4.4bar
Max. pump capacity	3500 l/h
Max. suction height	7m
Max. pressure height	44m
Max. water temperature	35° C
For clean/dirty water	clean
Barcode	 5 400338 041969 >

SPECIFICATIONS
<ul style="list-style-type: none"> • 1.2m ELECTRIC CABLE (RNF) WITH EARTHED PLUG • CARRYING HANDLE • ABS MOTOR HOUSING • STAINLESS STEEL COVERED NYLON PUMP HEAD • BUILT-IN FILTER

**CLEAN
water**

1200W

MAX.
PRESSURE
HEIGHT
50m

**MECHANICAL
SEAL**

**STAINLESS
STEEL AXLE**



PRESSURE SWITCH

MODEL	POWXG9447
Voltage / frequency	230V~ 50Hz
Power	1200W
Rated pressure	5bar
Max. pump capacity	3800 l/h
Max. suction height	7m
Max. pressure height	50m
Max. water temperature	35° C
For clean/dirty water	clean
Barcode	 5 400338 041976 >

SPECIFICATIONS
<ul style="list-style-type: none"> • 1.2m ELECTRIC CABLE (RNF) WITH EARTHED PLUG • CARRYING HANDLE • ABS MOTOR HOUSING • BUILT-IN FILTER • EDWC (ELECTRONIC SWITCH) • STAINLESS STEEL COVERED NYLON PUMP HEAD

Pressure pumps

HYDROFOORGROEPEN - GROUPES HYDROPHORES - DRUCKPUMPEN - BOMBAS DE PRESIÓN



BUILT-IN FILTER



MAX. PRESSURE HEIGHT

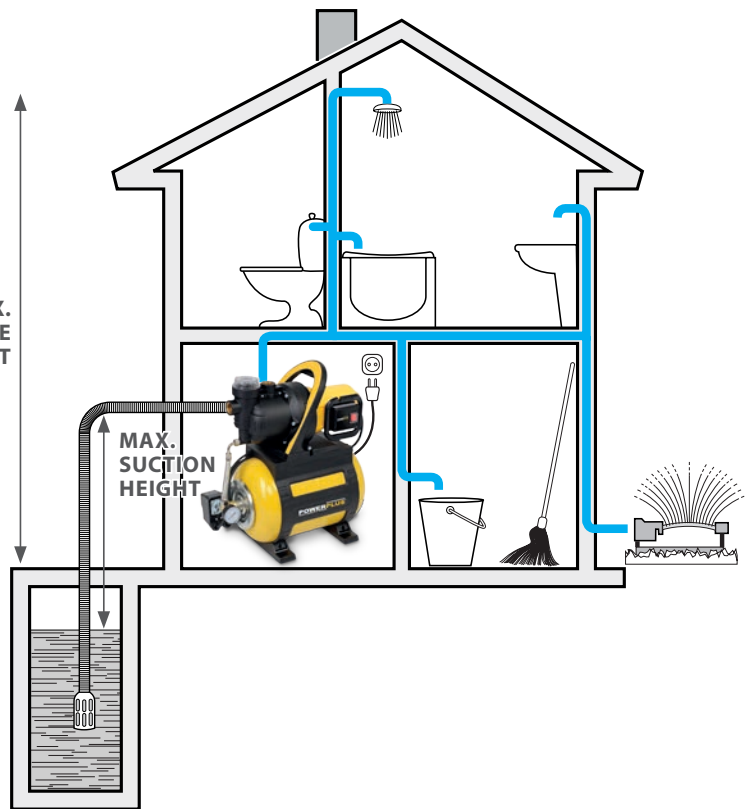

CLEAN water

800W

MAX. PRESSURE HEIGHT
40m

MECHANICAL SEAL

STAINLESS STEEL AXLE



STEEL TANK CAPACITY
25L

MODEL	POWXG9451
Voltage / frequency	230V~ 50Hz
Power	800W
Tank capacity	25 l
Rated pressure	4bar
Max. pump capacity	3200 l/h
Max. suction height	7m
Max. pressure height	40m
Max. water temperature	35° C
For clean/dirty water	clean
Barcode	 5 400338 041983 >

SPECIFICATIONS
<ul style="list-style-type: none"> • 1.2m ELECTRIC CABLE (RNF) WITH EARTHED PLUG • CARRYING HANDLE • ABS MOTOR HOUSING • BUILT-IN FILTER • NYLON PUMP HEAD

CLEAN
water

1200W

MAX.
PRESSURE
HEIGHT
50m

MECHANICAL
SEAL

STAINLESS
STEEL AXLE

STEEL TANK
CAPACITY
25L



MODEL	POWXG9453
Voltage / frequency	230V~ 50Hz
Power	1200W
Tank capacity	25 l
Rated pressure	5bar
Max. pump capacity	3800 l/h
Max. suction height	7m
Max. pressure height	50m
Max. water temperature	35° C
For clean/dirty water	clean
Barcode	 5 400338 041990 >

SPECIFICATIONS

- 1.2m ELECTRIC CABLE (RNF) WITH EARTHED PLUG
- CARRYING HANDLE
- ABS MOTOR HOUSING
- BUILT-IN FILTER
- STAINLESS STEEL COVERED NYLON PUMP HEAD

CLEAN
water

1200W

MAX.
PRESSURE
HEIGHT
50m

MECHANICAL
SEAL

STAINLESS
STEEL AXLE

STAINLESS
STEEL TANK
CAPACITY
25L



MODEL	POWXG9456
Voltage / frequency	230V~ 50Hz
Power	1200W
Tank capacity	25 l
Rated pressure	5bar
Max. pump capacity	3800 l/h
Max. suction height	7m
Max. pressure height	50m
Max. water temperature	35° C
For clean/dirty water	clean
Barcode	 5 400338 042003 >

SPECIFICATIONS

- 1.2m ELECTRIC CABLE (RNF) WITH EARTHED PLUG
- CARRYING HANDLE
- ABS MOTOR HOUSING
- BUILT-IN DIRT FILTER
- STAINLESS STEEL COVERED NYLON PUMP HEAD
- STAINLESS STEEL TANK

Accessories

ACCESSORIES – ACCESSOIRES – ZUBEHÖR – ACCESORIOS



Compatible with all our water pumps



MODEL	POW67F Outlet submersible pumps
Type	6/4" F
Barcode	 5 400338 029554 >



MODEL	POW68M Outlet garden pumps
Type	5/4" M
Barcode	 5 400338 029561 >



MODEL	POWXG94AH Aspiration hose
Hose	1" - 8m
Barcode	 5 400338 042010 >



MODEL	POWXG94F1 Filter
Capacity	1 litre
Clean water	YES
Barcode	 5 400338 042027 >

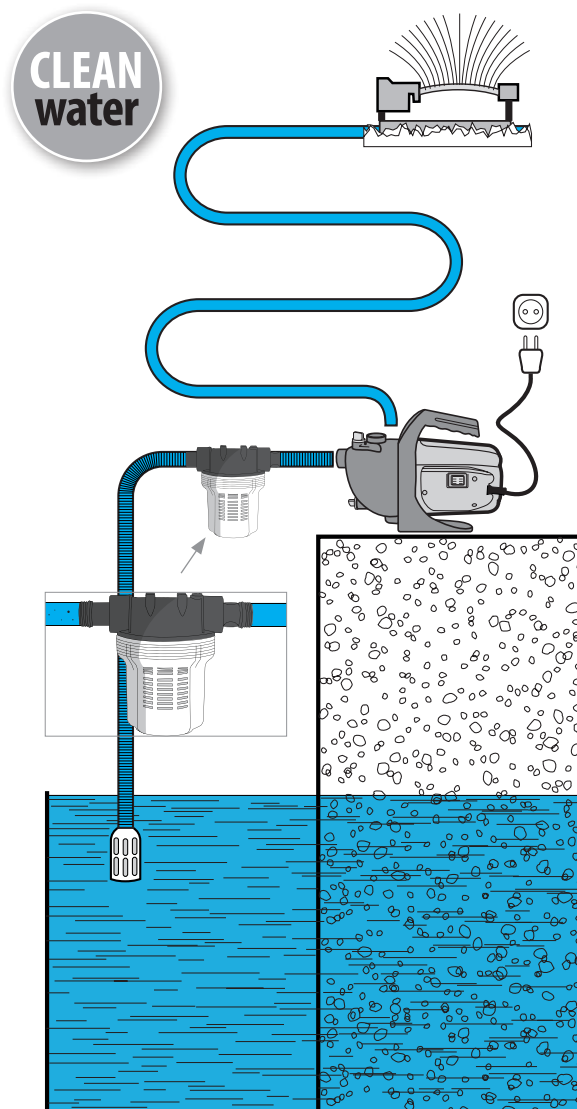



VARO♂

VIC. VAN ROMPUY nv

JOSEPH VAN INSTRAAAT 9
2500 LIER - BELGIUM
TEL +32 (0)3 292.92.92
FAX +32 (0)3 292.92.72
E-MAIL: INFO@VARO.COM
WWW.VARO.COM

OFFICES:

IBERICA BRICOLAGE S.L. - ESPAÑA
ASIA PACIFIC HONG KONG Ltd / SHANGHAI PRC
AUSTRALIA Pty Ltd / GERMANY GmbH